

2015 Rogue (T32) Rear Door Lock Assembly
Voluntary Recall Campaign

Reference: PC382
Date: July 17, 2015



Innovation
that excites

Attention: Dealer Principal, Sales, Service & Parts Managers

*****Dealer Announcement*****

A STOP SALE CONDITION IS IN EFFECT.

Affected Models/Years:	Affected Population:	Dealer Inventory:	SERVICE COMM Activation date:
2015 Rogue	~41	24	July 17, 2015

***** Campaign Summary *****

Nissan is conducting a Voluntary Recall Campaign in U.S. on approximately 41 MY2015 Nissan Rogue vehicles to inspect and, if necessary, replace the rear door lock assembly.

This announcement supersedes previously announced Quality Assurance hold and Dealer Inventory Inspection.

IMPORTANT: It is a violation of Federal law for retailers to sell or deliver vehicles in their inventory covered by this notification until the remedy is performed.

***** What Dealers Should Do*****

PLEASE FOLLOW THE ATTACHED INSPECTION INSTRUCTIONS:

1. Verify if newly arriving vehicles or vehicles currently in dealer inventory are affected by this Voluntary Recall Campaign using Service Comm I.D. **PC382**
2. If inspection shows that the Julian date and cavity code on the left rear door latch are not within the affected range, submit the warranty claim and release the vehicle without further action.
3. If inspection shows that the Julian date and cavity code on the left rear door latch **are** within the affected range:
 - Order the part via the order form.
 - **Hold** the vehicle until the part shipment arrives.
 - Once the part arrives, repair the vehicle using the attached procedure, submit the warranty claim, and release the vehicle.

******* Release Schedule *******

Parts	<ul style="list-style-type: none">Parts are currently on restriction and may be ordered via parts order form, Nissan expects to receive parts the week of July 20th.No special tools are required for this campaign
Rental	<ul style="list-style-type: none">Rental will be available under the campaign, until parts are readily available. Expense Code 502, @ \$40 per day. Dealers will need to contact the Warranty Claims Call Center to approve rentals exceeding 3 days.
Repair	<ul style="list-style-type: none">An interim repair procedure is attached. The campaign bulletin is under development and will be the subject of a future announcement.
Owner Notification	Nissan will begin notifying owners of all potentially affected vehicles in late August, 2015 via U.S. Mail.

******* Dealer Responsibility *******

It is the dealer's responsibility to check Service Comm using the appropriate Campaign I.D. for the campaign status on each vehicle falling within the range of this voluntary recall campaign which for any reason enters the service department. This includes vehicles purchased from private parties or presented by transient (tourist) owners and vehicles in dealer inventory. If a VIN subject to this recall campaign was part of a dealer trade, the letter associated with that VIN should be forwarded to the appropriate dealer for service completion.

Thank you for your prompt attention to this matter and we apologize for the inconvenience.

NISSAN NORTH AMERICA, INC.
Aftersales DIVISION

Frequently Asked Questions (FAQ):

Q. Is this a safety recall?

A. Yes.

Q. What is the reason for this Voluntary Recall Campaign?

A. Due to a supplier issue that has since been corrected, the front and rear (Sentra/Versa Note) and left rear (Rogue) door lock assembly may not fully latch.

Q. What is the possible effect of the condition?

A. The door lock assembly may not fully latch.

Q. What will be the corrective action for this Voluntary Recall Campaign?

A. Nissan dealers will inspect the Julian date, lot code, and cavity code on the left side rear door lock assembly on the subject vehicles. If the date, lot, or cavity code fall within the suspect range, the door lock assembly will be replaced.

Q. How long will the corrective action take?

A. This service, free for parts and labor, should take approximately 1 hour to complete. However, your Nissan dealer may require your vehicle for a longer period of time based upon their work schedule.

Q. When will vehicle owners be notified?

A. Nissan will begin notifying owners in August, asking them to bring their vehicle to an authorized Nissan dealer to have their vehicle inspected and if necessary, door lock assembly replaced.

Q. Are parts readily available?

A. No. Nissan expects to have replacement parts for:

- Rogue: Available the week of July 20th, 2015
- Sentra: Available the week of July 27th, 2015
- Versa Note: Available the week of August 10, 2015

Q. Is my vehicle safe to drive?

A. Yes. However, if your vehicle is subject to the voluntary recall campaign, you should make arrangements to have your vehicle remedied as soon as possible.

Q. What do I do if an issue is detected and the door will not latch?

A. Please contact your dealership as soon as possible to arrange for alternate transportation.

Q. Have there been any injuries or fatalities related to this problem?

A. No.

Q. Will a rental vehicle be provided while the dealer is servicing the vehicle?

A. Yes. Rental will be available under the campaign, until parts are readily available. Expense Code 502, @ \$40 per day. Dealers will need to contact the Warranty Claims Call Center to approve rentals exceeding 3 days for Rogue vehicles (5 days for Sentra and Versa vehicles).

Q. I have lost confidence in the vehicle. Will Nissan replace or repurchase the vehicle?

A. The repair will fully correct this condition. As the condition will be corrected, there is no basis for repurchasing or replacing your vehicle.

Q. Is there anything owners can do to mitigate the condition?

A. No.

Q. Is there any charge for the repair?

A. No, the repair will be performed for the customer free of charge for parts and labor.

Q. Will I have to take my vehicle back to the selling dealer to have the service performed?

A. No, any authorized Nissan dealer is able to perform the voluntary recall campaign. **For CA:** Please inform us of the dealer where you would like to have the corrective action completed.

Q. What model year vehicles are involved?

A. 2015 Nissan Rogue, Versa Note, Sentra vehicles are involved.

Q. How many vehicles are involved in the campaign?

A. The North American Market is affected as follows:

Region	Sentra	Versa note	Rogue	Total
USA	5,204	1,273	41	6,518
CANADA	225	161	101	487
GUAM	13	0	0	13
PUERTO RICO	64	0	0	64
Other Markets	1,068	154	0	1,222
Total	6,574	1,588	142	8,304

Make/Model	Dates of Manufacture
MY2015 Nissan Sentra	June 5, 2015 to June 13, 2015
MY2015 Nissan Versa Note	June 5, 2015 to June 13, 2015
MY2015 Nissan Rogue	June 9, 2015 to June 10, 2015



Door Lock Assembly Inspection Procedure

2015 Sentra/Versa Note and Rogue

REPAIR OVERVIEW

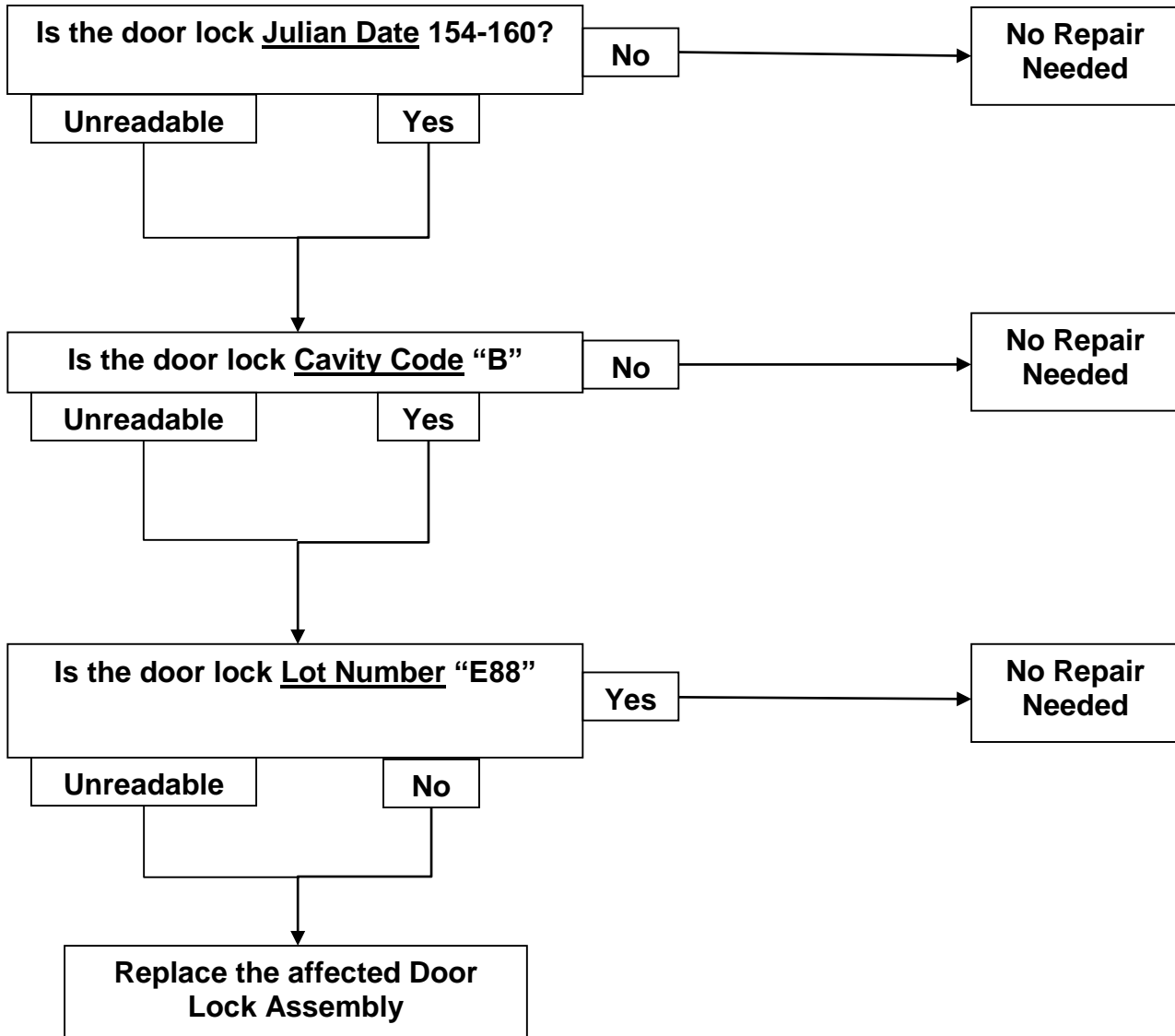

SERVICE PROCEDURE:

1. Locate door lock Julian Date on applicable vehicle door/s listed below.

- **Sentra/Versa Note:**
Left Front and Left Rear Doors
- **Rogue:**
Left Rear Door ONLY

2. Inspect first three digits of the above model specified door lock(s) Julian Date. Refer to Figure 2.

- If the first three Julian date digits **ARE** within (including) **154-160 or Unreadable**, continue to Step 3.
- If the first three Julian date digits are **NOT** within (including) **154-160**, then submit claim and release the vehicle.

3. Remove the Door Finisher of the door/s with a suspect lock identified in Step 2.

- Verify door window is in the full up position.
- Refer to the applicable Electronic Service Manual (ESM). Section INT-Interior, for removal procedures.



Figure 1

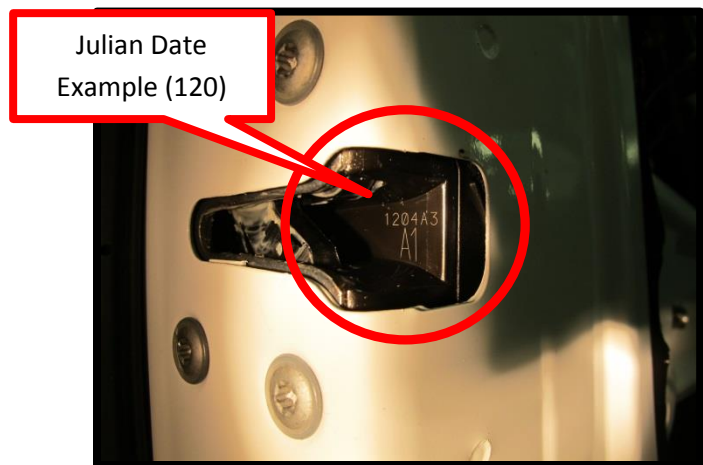

Figure 2

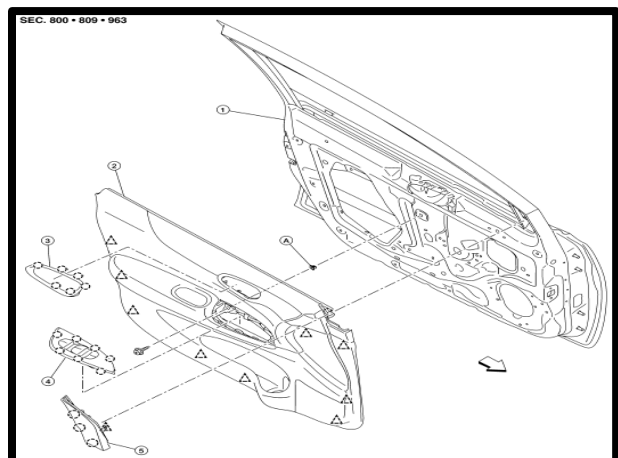

Figure 3

4. Working from the rear of the door, partially peel back the vapor barrier from door panel.

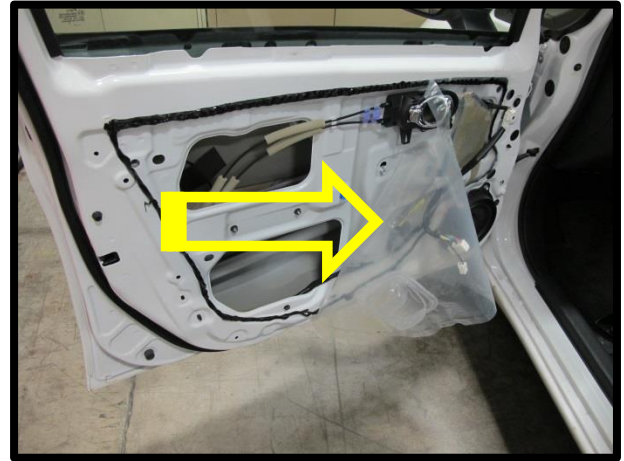

Figure 4

5. Front Doors ONLY:

Disconnect the key rod at the door lock assembly.

- Open yellow key rod holder (1) by pulling downward and separate key rod (3) from door lock assembly (2). See Figure 5.
- Use care to not damage yellow key rod holder as it must be reused.

Front Door ONLY

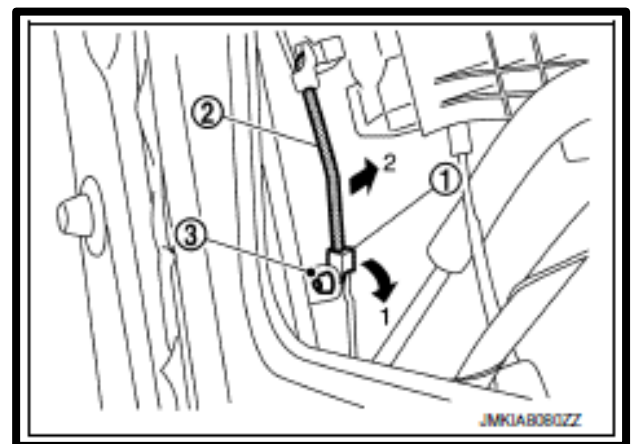

Figure 5

6. Vehicles Equipped With Power Door Locks:

Disconnect door lock harness retainer from the door.

- Pinch clips on both sides of the harness retainer while pushing the retainer into the door (Figure 6).

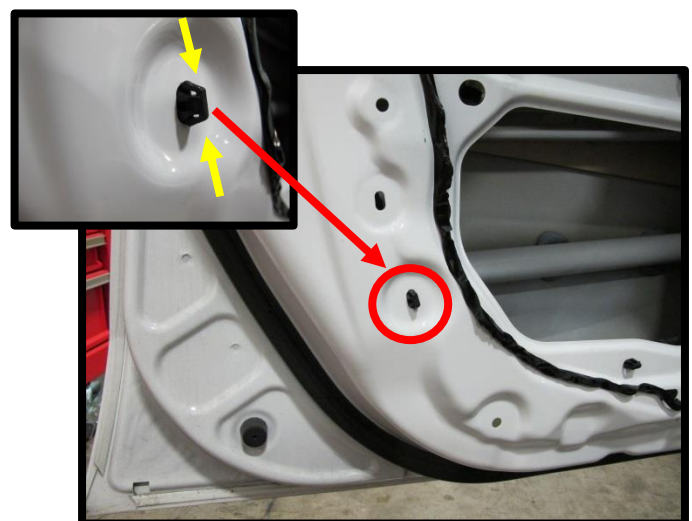

Figure 6

7. Remove the rear window run from the door.

All except Sentra Left Rear Door. See Figure 7.

- Remove the (2) 10mm run channel retaining bolts.
- Slide rear window run channel down and remove it from the door.

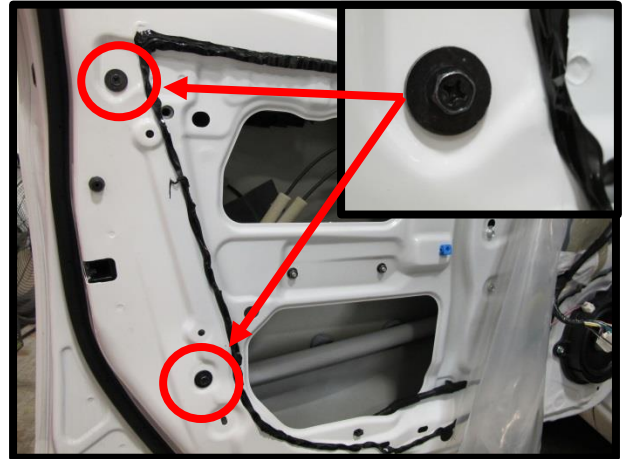

Figure 7

Sentra Left Rear Door ONLY. Refer to Figure 8.

- Remove the (1) 10 mm run channel retaining bolt.
- Push the bottom of rear window run back providing clearance to remove the door lock assembly.
- Do NOT attempt to remove the run channel as it is attached to the door at the top and could cause run channel damage.

Sentra Left Rear Door



Figure 8

8. Remove door lock assembly retaining bolts.

- Remove the (3) T-27 Torx head bolts and discard (**Do NOT reuse**). See Figure 9.
- During door lock assembly installation, tighten door lock screws to 5.8 Nm (51 in-lb).



Figure 9

9. Vehicles Equipped With Power Door Locks:

Locks:
Disconnect the door lock harness connector.



Figure 10

10. Pull the door lock assembly out of the door.

- Do not kink the door lock cables or disconnect them from the door handles.



Figure 11

11. Inspect door lock assembly for Cavity Code stamped on plate edge.
See Figures 12 & 13.

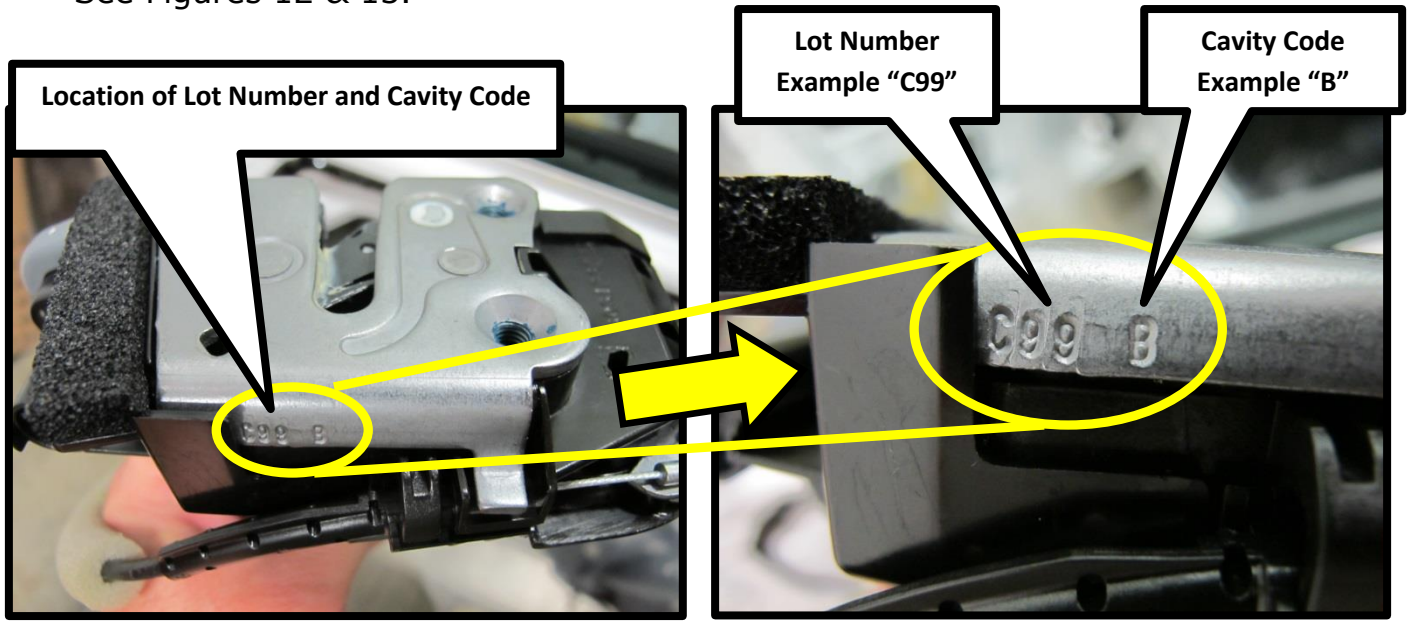

Figure 12

Figure 13

- If the Cavity Code stamped on the plate edge is "**NOT** a "B", then reassemble the vehicle, submit claim and release vehicle.
- If the Cavity Code stamped on the plate edge **IS** a "B", then proceed to Step 12.
 - If the Cavity Code **Cannot be Determined**, then, proceed to Step 12.

12. Inspect door lock assembly for Lot Number stamped on plate edge. See Figures 12 & 13.

- If the Lot Number stamped on the plate edge **IS** an "E88", then reassemble the vehicle, submit claim and release the vehicle.
- If the Lot Number stamped on the plate edge is **NOT** an "E88", then replace the affected door lock assembly. Refer to the applicable Electronic Service Manual (ESM). Section DLK-Door & Lock, for replacement procedures.
- If the Lot Number stamped on the plate edge **Cannot be Determined**, then replace the affected door lock assembly. Refer to the applicable Electronic Service Manual (ESM). Section DLK-Door & Lock, for replacement procedures.

PARTS INFORMATION:

Description	Part #
Door Lock Assembly	Order Through Normal Nissan Parts Order System
Screw (3 per lock required)	80599-AX00E

CLAIMS INFORMATION:

NOTE: All inspection and door lock replacements pertain to the Driver (Left) side ONLY.

CAMPAIGN ("CM") I.D.	DESCRIPTION	OP CODE	FRT	VEHICLE APPLICATION
PC382	Inspect Julian Date ONLY	PC3820	0.2H	Rogue
PC382	Inspect Julian Date, R&R Rear Door Finisher	PC3821	0.3H	Rogue
PC382	Inspect Julian Date, Replace Rear Door Lock	PC3822	0.3H	Rogue
PC383	Inspect Julian Date ONLY	PC3830	0.2H	Sentra & Versa
PC383	Inspect Julian Date, R&R (1) Door Finisher	PC3831	0.3H	Sentra & Versa
PC383	Inspect Julian Date, R&R (2) Door Finishers	PC3832	0.5H	Sentra & Versa
PC383	Replace Front Door Lock, Inspect Rear Julian ONLY	PC3833	0.3H	Sentra
PC383	Replace Front Door Lock, Inspect Rear Julian ONLY	PC3834	0.5H	Versa
PC383	Replace Rear Door Lock, Inspect Front Julian ONLY	PC3835	0.4H	Sentra & Versa
PC383	Replace Front Door Lock, R&R Rear Door Finisher	PC3836	0.5H	Sentra
PC383	Replace Front Door Lock, R&R Rear Door Finisher	PC3837	0.7H	Versa
PC383	Replace Rear Door Lock, R&R Front Door Finisher	PC3838	0.6H	Sentra & Versa
PC383	Replace Both Front & Rear Door Locks	PC3839	0.6H	Sentra
PC383	Replace Both Front & Rear Door Locks	PC383A	0.8H	Versa