

- ATTENTION:**
- GENERAL MANAGER
  - PARTS MANAGER
  - CLAIMS PERSONNEL
  - SERVICE MANAGER

IMPORTANT - All Service Personnel Should Read and Initial in the boxes provided, right.

© 2015 Subaru of America, Inc. All rights reserved.



QUALITY DRIVEN® SERVICE

**PRODUCT CAMPAIGN BULLETIN**

**APPLICABILITY:** 2009-2013 Subaru Forester  
 2008-2011 Subaru Impreza, WRX, and STI  
 2012-2014 Subaru WRX and STI

**NUMBER:** WQQ-52R  
**DATE:** January 2015  
**REVISED:** July 2017  
**NHTSA ID:** 14V-830

**SUBJECT:** Application of Anti-Corrosion Material to the Four-Way (2-2 way) Joint Connector of the Brake Line System

**This recall is being issued as a result of incomplete repair instructions provided in the Impreza and Forester repair procedure for the WQK-47 Brake Line Corrosion recall.**

Due to incomplete repair instructions previously provided in the WQK-47 recall bulletin, the WQQ-52 recall will involve applying additional anti-corrosion material to the four-way (2-2 way) joint connector area of the brake line system on Forester, Impreza, WRX, and STI vehicles previously repaired under the WQK-47 (14V-311) brake line corrosion recall prior to the December 23, 2014 WQK-47 recall bulletin revision.

Subaru of America, Inc. (SOA) previously determined that a defect, which relates to motor vehicle safety, exists on certain 2009-2013 Subaru Forester vehicles, 2008-2011 Subaru Impreza, WRX, and STI vehicles, and 2012-2014 Subaru WRX and STI vehicles currently or formerly registered in at least one of the “salt-belt” states or the District of Columbia listed below.

Connecticut	Maine	New Hampshire	Vermont
Delaware	Maryland	New Jersey	West Virginia
District of Columbia	Massachusetts	New York	Wisconsin
Illinois	Michigan	Ohio	
Indiana	Minnesota	Pennsylvania	
Iowa	Missouri	Rhode Island	

These vehicles may have been manufactured with brake lines that could, over time, corrode in the area of the four-way (2-2 way) joint connector or in the areas where there are no resin covers installed if exposed to salt, such as salt used to treat roads in the winter time. Excessive corrosion could eventually cause perforation of a brake line(s) resulting in a brake fluid leak.

Should a brake line corrode to the point of developing a perforation, brake fluid will leak from the line(s) causing the related circuit to eventually lose effectiveness. In this situation, there would be an increase in the amount of brake pedal travel distance and foot pressure required to slow or stop the vehicle. This might cause the driver to misjudge the amount of brake pedal travel required to achieve the desired stopping distance, increasing the risk of a crash.

**AFFECTED VEHICLES**

Potentially affected vehicles are identified in the VIN range charts below. Not all vehicles within the VIN ranges are affected. Coverage for all affected vehicles must be confirmed by using the Vehicle Coverage Inquiry function on [subarunet.com](http://subarunet.com).

*Continued...*

The affected vehicles include certain: 2009-2013 Subaru Forester vehicles; 2008-2011 Subaru Impreza, WRX, and STI vehicles; and 2012-2014 Subaru WRX and STI vehicles repaired prior to December 23, 2014 under the WQK-47 (14V-311) brake line corrosion recall.

**Please note:**

Impreza, WRX, STI, and Forester vehicles affected by the WQK-47 recall which were not repaired prior to the December 23, 2014 bulletin revision must be repaired under the WQK-47 recall following the complete repair instructions in the revised WQK-47 bulletin.

<b>MODEL</b>	<b>MY</b>	<b>CARLINE(S)</b>	<b>START VIN (last 8 digits)</b>	<b>END VIN (last 8 digits)</b>
<b>Forester</b>	2009	Forester	9*700001	9*797855
	2010	Forester	A*700001	A*918317
	2011	Forester	B*700001	B*783898
	2012	Forester	C*400002	C*470750
	2013	Forester	D*400001	D*446782
<b>Impreza</b>	2008	4 -Door (except STI)	8*500001	8*530288
	2008	5 -Door (except STI)	8*800001	8*838495
	2008	5 -Door (STI)	8L809673	8L837138
	2009	4 -Door (except STI)	9*500399	9*522884
	2009	5 -Door (except STI)	9*800001	9*828092
	2009	5 -Door (STI)	9L800020	9L828023
	2010	4 -Door (except STI)	A*500001	A*517646
	2010	5 -Door (except STI)	A*800003	A*828797
	2010	5 -Door (STI)	AL800010	AL826680
	2011	4 -Door (except WRX and STI)	B*500001	B*523841
	2011	5 -Door (except WRX and STI)	B*800001	B*832332
	2011	4 -Door (WRX and STI)	B*500742	B*525817
	2011	5 -Door (WRX and STI)	B*801433	B*833719
	2012	4 -Door (WRX and STI)	C*002099	C*031281
	2012	5 -Door (WRX and STI)	C*200094	C*246471
	2013	4 -Door (WRX and STI)	D*002007	D*035278
	2013	5 -Door (WRX and STI)	D*200100	D*895579
	2014	4 -Door (WRX and STI)	E*002001	E*016827
	2014	5 -Door (WRX and STI)	E*200001	E*270263

\*Various characters may occupy this position of the VIN.

*Continued...*

## OWNER NOTIFICATION

A copy of the Owner Notification Letter is included at the end of this bulletin.

- Owner notification will begin on or about January 26, 2015.
- Notification letters will be sent to owners of vehicles showing a WQK-47 repair completion date prior to the December 23, 2014 bulletin revision.
- Notification letters will be mailed in April, 2015 for additional affected vehicles identified by claims submitted throughout the 90-day claim submission period.

## RETAILER AFFECTED VIN LISTS

Each Subaru retailer will receive an affected VIN list from their Zone office around the time initial owner notification begins. Vehicles will be assigned to retailers in the affected VIN list as follows:

- Original vehicle owners are assigned to the original selling retailer when their current address is within a 100 mile radius of that retailer.
- If the original selling retailer is inactive, the VIN has been assigned to the nearest active retailer.
- For any new owners or when original owners live more than 100 miles from the original selling retailer, the VIN has been assigned to the nearest active retailer.

**Important: Retailer affected VIN lists include owner name and address information for vehicles affected by this recall. This information will enable retailers to follow-up with owners of potentially affected vehicles. The lists contain owners' names and addresses obtained from State Motor Vehicle Registration Records. The use of such motor vehicle registration data for any other purpose is unlawful. Accordingly, retailers are required to limit the use of these lists for the purpose of completion of this safety recall.**

## SUBARU RETAILER PROGRAM RESPONSIBILITY

Subaru retailers are to promptly perform the applicable service procedures defined in this bulletin to correct all affected vehicles in their inventory (new, used, demo & SSLP). Additionally, whenever a vehicle subject to this recall is taken into the retailer's new or used inventory or into the retailer for service, necessary steps should be taken to ensure the recall correction has been made before selling or releasing the vehicle.

New, used, demo or SSLP (Subaru Service Loaner Program) vehicles listed in a recall/campaign that are in the retailer's stock must be:

- Immediately identified.
- Tagged or otherwise marked to prevent their delivery or use prior to inspection and/or repair.
- Repaired in accordance with the repair procedures outlined in this Product Campaign Bulletin.

*Continued...*

Please be advised that it is a violation of Federal law for a retailer to deliver a new motor vehicle covered by a recall under a sale or lease until the defect is remedied. Therefore, any authorized Subaru retailer failing to perform the applicable service procedures as defined in this bulletin to correct all affected vehicles in their inventory (new, used, demo & SSLP) prior to the vehicle being placed in service may be subject to civil penalties of up to \$7,000 per violation (i.e., for each vehicle), as provided in 49 CFR §578.6 and will also be in breach of the Subaru Dealer Agreement.

## SPECIAL TOOLS INFORMATION

All Subaru retailers previously received one spray gun and one nozzle at no charge to perform the WQK-47 recall repairs. The same spray gun equipment will be used for the WQQ-52 repairs. Additional spray guns and nozzles will be available on a limited basis therefore they will be on hold in the SOA Parts system. Please contact the Parts Information Coordinators at (1-866-SUBARU2) 1-866-782-2782 for additional information.

PART NUMBER	DESCRIPTION
SOA635134	WQK-47 Spray Gun (does not include nozzle)
SOA635135	WQK-47 Nozzle

## PARTS INFORMATION

### **Nox-Rust® 712AM Rust-proofing Material:**

The Nox-Rust® 712 AM rust-proofing material is available through the “Genuine Subaru Automotive Chemical” program. This material comes in one liter bottles, packed in a case of 10 bottles. Each one liter bottle contains enough material to perform 27 WQQ-52 recall repairs.

**Exposure Controls for use of Nox-Rust® 712AM:** The Material Safety Data Sheet (MSDS) which provides storage and handling procedures for this product is included at the end of this bulletin.

**For parts ordering purposes,** retailers should use the part number listed below. Each case contains 10 bottles. The part number listed below is for one bottle, however retailers must order in case quantities of 10.

ORDERING PART NUMBER	APPLICABILITY	DESCRIPTION	CASE/ ORDER QUANTITY
SOA868V9390	All models	Nox-Rust® 712AM (one liter bottle) (Enough material to cover 27 WQQ-52 repairs)	10

**For claim reimbursement purposes,** retailers should use the part number listed below which represents rust proofing materials sufficient for one vehicle application.

CLAIM PART NUMBER	APPLICABILITY	DESCRIPTION	CLAIM QUANTITY
SOA635137	All models	Nox-Rust® 712AM Rust-proofing material – one repair (for claim purposes only)	1

*Continued...*

## SERVICE PROCEDURE

This Campaign involves a cleaning, inspecting and testing of the brake pipes where they connect to the four-way (2-2way) joint connector. Corrosion may develop in areas of these brake pipes not protected by a resin cover and eventually perforate them causing brake fluid seepage. If seepage is verified during the inspection procedures, the affected brake pipes must be replaced. If no seepage is verified, application of a protective rustproofing wax material to these specific sections of the brake pipes will be required to complete this Campaign. The inspection and rustproofing procedures are all performed through the inspection cover opening on the right-hand (passenger side) of the plastic fuel tank cover. The following illustrations provide an overview of the affected areas.

### Assembling of Spray Gun:



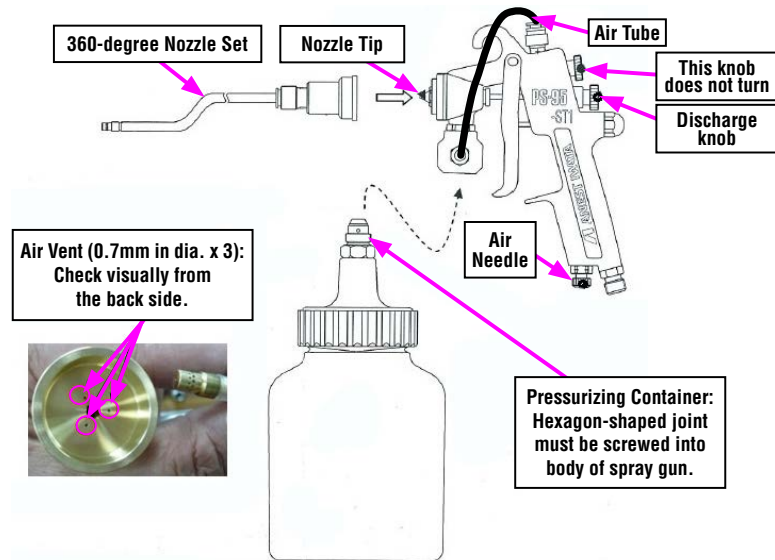

**IMPORTANT:** Be careful not to damage or deform the nozzle tip.

Installation of an in-line air pressure regulator is highly recommended to ensure air pressures do not exceed the maximum use pressure as stated by the spray gun manufacturer (**71 PSI MAXIMUM**)





### Adjusting of Spray Gun:

#### A: Zero-point Setting of Discharge Knob and Air Needle

Zero-point Setting of Discharge Knob	
a) Fully close by rotating the knob clockwise.	b) Mark the screw at stop (zero) point.
	
Discharge Knob	Zero-point Mark
Zero-point Setting of Air Needle	
a) Fully open by rotating the needle counter-clockwise.	b) Mark the screw at stopped (zero) point.
	
Air Needle	Zero-point Mark

#### B: Adjustment of Wax Amount and Air Volume

Discharge Knob	Opening state from full-close: Summer: 3/4 turn Winter: 4 turns	
Air Needle	Closing state from full-open: All seasons: 1 full turn	
Compressor Air Pressure	Summer: 51 PSI Winter: 71 PSI <b>Never Exceed 71 PSI</b>	
Remarks	The adjustments above are required as wax temperatures will change between summer and winter. Additional pressure adjustments may be needed to achieve the required results.	

*Continued...*

# WQQ-52 SERVICE PROCEDURE FLOW CHART

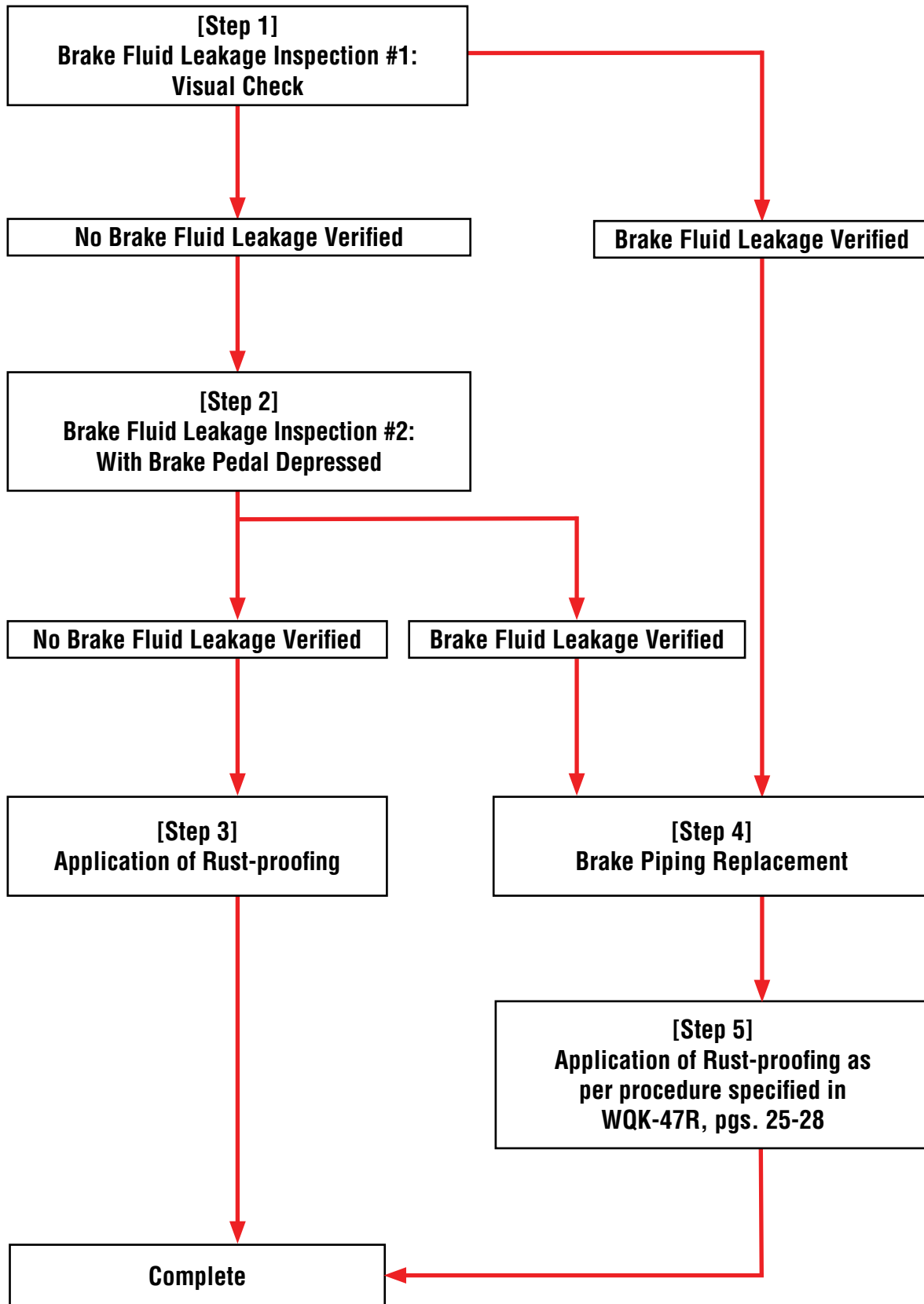

*Continued...*

## [Step 1] BRAKE FLUID LEAKAGE INSPECTON 1: VISUAL CHECK

### (1) Preparation:

(1-1) Raise the vehicle on a lift.

(1-2) Open inspection hole door on fuel tank cover (Photo 1). located on the right-hand side of the vehicle.



### (2) Locate affected Brake Pipes

(2-1) Confirm the location of Brake Pipe Portion E at 2-2 Way Connector (Photo 2).

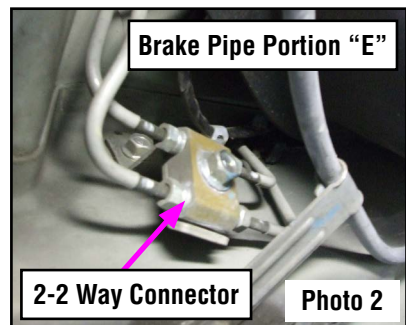

**IMPORTANT:** Even if the 2-2 Way Connector appears to have been previously rust-proofed, the balance of this recall procedure must still be completed in its entirety.

**NOTE:** Removal of the plastic fuel tank protector is not required to perform this recall procedure. The protector was removed to provide a better photographic representation of the areas involved.

### (3) Mud and Dust Removal:

**IMPORTANT:** If the brake pipe area is wet due to rain or snow, blow dry with compressed air prior to starting the process.

(3-1) Use a tooth brush (plastic bristle) and compressed air to carefully remove dust and dirt (Photo 3).

**IMPORTANT: NEVER** use a metal / wire brush!

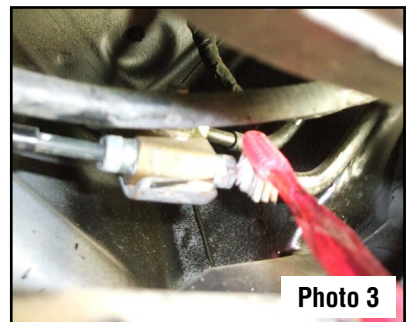

*Continued...*

**(4) Visual Check:**

- (4-1) Check for fluid leakage from Brake Pipe Portion E from the areas indicated (Photo 4).

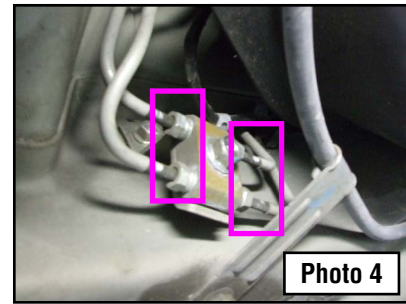

**(5) Determination of Required Repairs:**

- (5-1) If no brake fluid leakage is verified: Proceed to [Step 2] **BRAKE FLUID LEAKAGE INSPECTION #2 WITH BRAKE PEDAL DEPRESSED.**
- (5-2) If brake fluid leakage is verified: Proceed to [Step 4] **BRAKE PIPING REPLACEMENT.**

**IMPORTANT:** The decision to replace brake piping should strictly be made **ONLY** when brake fluid leakage is verified. Replacement of brake piping due to other reasons including surface rust are not a matter for warranty. Questions related to any out of warranty concerns should be directed to your DPSM.

**[Step 2] BRAKE FLUID LEAKAGE INSPECTION #2 WITH BRAKE PEDAL DEPRESSED**

**(1) Preparation:**

- (1-1) Lower the vehicle.

**(2) Depressing Brake Pedal Procedure:**

- (2-1) Start the engine and allow it to idle.
- (2-2) Measure dimension “L2” (foot off pedal) as shown in Drawing 2.
- (2-3) Depress the brake pedal until the dimension from steering wheel to brake pedal “L1” becomes 110mm greater than dimension “L2”.
- (2-4) Hold the brake pedal in that position for about 3 seconds.
- (2-5) Shut off the engine.
- (2-6) Raise the vehicle.

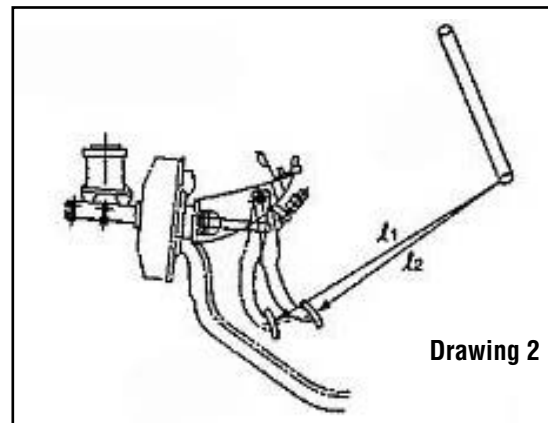

*Continued...*



**(3) Visual Check:**

- (3-1) Check for fluid leakage from Brake Pipe Portion E from the areas indicated (Photo 5).

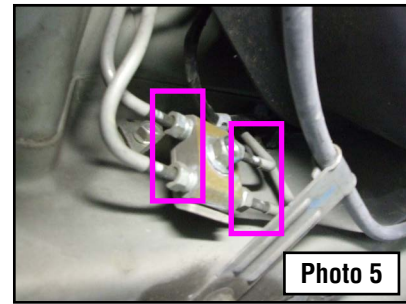

**(4) Determination of Required Repairs:**

- (4-1) If no brake fluid leakage is verified, Proceed to [Step 3] **APPLICATION of RUST-PROOFING.**
- (4-2) If brake fluid leakage is verified: Proceed to [Step 4] **BRAKE PIPING REPLACEMENT.**

**IMPORTANT:** The decision to replace brake piping should be made **ONLY** when brake fluid leakage is verified. Replacement of brake piping due to other reasons including surface rust is not a matter for warranty. Questions related to any out of warranty concerns should be directed to your DPSM.

*Continued...*

### [Step 3] APPLICATION OF RUST-PROOFING

#### IMPORTANT:

- Always wear safety goggles and a particle mask.
- Keep away from open flame.

#### (1) Preparation:

**REMINDER:** Never exceed 71 PSI air pressure to the spray gun.

- (1-1) Assemble the spray gun and nozzle according to the spray gun assembly and adjusting instructions outlined above.
- (1-2) Set zero-point of discharge knob and air needle of spray gun.
- (1-3) Fill the tank with anti-rust wax.
- (1-4) Adjust wax amount and air volume by setting the discharge knob, air needle, and compressor air pressure of spray gun.
- (1-5) Test-spray wax to confirm gun operates as intended.



**IMPORTANT:** Application of wax should always be at room temperature as wax will not be spread effectively in cold temperatures.

#### (2) Application of Anti-Rust Wax:

Spray the anti-rust wax material onto each area as described using the suggested spraying time and amount listed: Spraying time: 3 seconds or more on each area.

- (2-1) Spraying Brake Pipe Portion E:
  - (2-1-1) Open the inspection hole door in the fuel tank cover and insert the nozzle. (Photo 6)



*Continued...*

(2-1-2) Insert the nozzle over the left-lower pipe of the 2-2 Way Connector. Remove the nozzle while spraying for 3 seconds or more. (Photo 7)

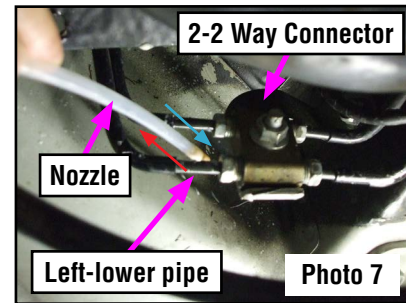

(2-1-3) Insert the nozzle over the left-upper pipe of the 2-2 Way Connector. Remove the nozzle while spraying for 3 seconds or more. (Photo 8)

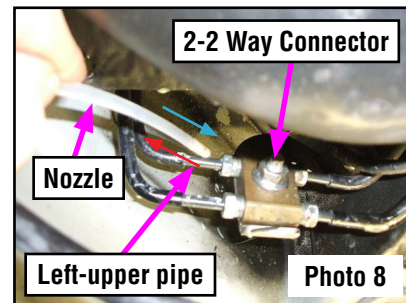

(2-1-4) Insert the nozzle over the right-upper pipe of the 2-2 Way Connector. Remove the nozzle while spraying for 3 seconds or more. (Photo 9)

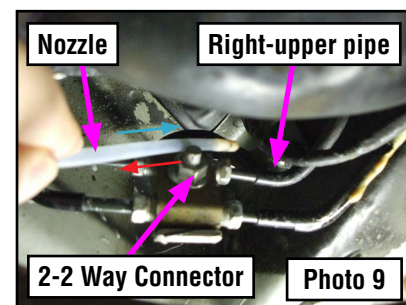

(2-1-5) Insert the nozzle over the right-lower pipe of the 2-2 Way Connector. Remove the nozzle while spraying for 3 seconds or more. (Photo 10)

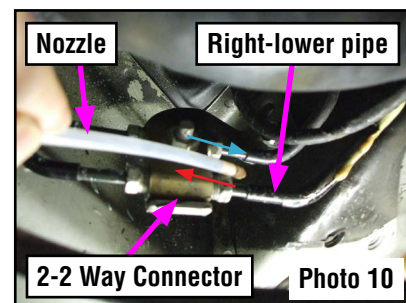

**IMPORTANT:**

- Spray until the sprayed wax material drips. (Photo 11)
- To insure the proper amount of wax is applied, follow the steps listed above closely.



*Continued...*

(3) Close inspection hole door and lower the vehicle.

**[Step 4] BRAKE PIPING REPLACEMENT (ONLY after confirming fluid leakage)**

Replace applicable PIPE ASSY CTR BK, and / or PIPE ASSY R with new parts using the applicable part numbers listed in the Parts catalog and following the procedure outlined in the applicable Service Manual. The 2-2 Way Connector can be reused.

**IMPORTANT:** After installation of any replacement brake piping is complete, the anti-rust wax material **must** be applied to any new components to complete the repair. Follow the procedures listed in Campaign WQK-47R, pgs. 25-28 for application of anti-rust wax material to any new brake piping.

*Continued...*

## RECALL IDENTIFICATION LABEL

Type or print the necessary information on a Service Program identification label. The completed label should be attached to the vehicle's upper radiator support.

Additional labels are available through normal parts ordering channels. The part number is MSA6P1302. Ordering qty 1 = 1 sheet of 20 labels.

PART NUMBER	APPLICABILITY	DESCRIPTION	ORDER QUANTITY
MSA6P1302	All models	Campaign Completion Labels (contains one sheet of 20 labels)	1

<b>SUBARU</b>
Campaign Code
<b>WQQ-52</b>
COMPLETED
DIST./DEALER NO.
SERIAL NO.
<b>DO NOT REMOVE</b>

## CLAIM REIMBURSEMENT AND ENTRY PROCEDURES

Credit to perform this recall will be based on the submission of properly completed repair order information. **Retailers may submit claims through [Subarunet.com](http://Subarunet.com).**

Listed below is claim entry information:

CLAIM TYPE	CAMPAIGN CODE	APPLICABILITY	LABOR	DESCRIPTION	LABOR TIME
RC	WQQ-52	Impreza, WRX, STI, and Forester	B153-540	Apply anti-corrosion material to the four-way joint connector	0.2
			C153-544	Brake Pipe Replacement	5.8

PART NUMBER	APPLICABILITY	DESCRIPTION	QUANTITY
SOA635137	All models	Nox-Rust® 712AM Rust-proofing material – one repair (for claim purposes only)	1

If brake piping replacement is necessary, please refer to the parts catalog for the applicable part numbers.

*Continued...*

# OWNER NOTIFICATION LETTER (FORESTER, IMPREZA, WRX AND STI)

**IMPORTANT SAFETY RECALL**  
**This notice applies to the VIN identified  
in the address section printed below.**



**Subaru of America, Inc**  
Subaru Plaza  
PO Box 6000  
Cherry Hill, NJ 08034-6000  
800-782-2783  
www.subaru.com

**Subaru Recall Campaign WQQ-52**  
**NHTSA Recall No. 14V-830**  
**January 2015**

**Dear Subaru Owner:**

This notice is sent to you in accordance with the National Traffic and Motor Vehicle Safety Act.

SUBARU OF AMERICA, INC. has decided that a defect, which relates to motor vehicle safety, exists in some 2009-2013 Subaru Forester models, some 2008-2011 model year Subaru Impreza, WRX, and STI vehicles, and in some 2012-2014 model year Subaru Impreza WRX and STI vehicles currently or formerly registered in at least one of the following states and the District of Columbia.

Connecticut	Maine	New Hampshire	Vermont
Delaware	Maryland	New Jersey	West Virginia
District of Columbia	Massachusetts	New York	Wisconsin
Illinois	Michigan	Ohio	
Indiana	Minnesota	Pennsylvania	
Iowa	Missouri	Rhode Island	

## **IMPORTANT**

In July, 2014 you were notified of a recall related to your vehicle's brake lines (NHTSA Recall Number 14V-311).

Our records indicate that you already had that recall repair performed. However, due to incomplete repair instructions provided to our retailers (dealers), your vehicle may not have been treated with the proper amount of anti-corrosion material.

**Additional anti-corrosion material needs to be applied to ensure your vehicle is treated as intended.**

We sincerely apologize for any inconvenience this matter may cause and urge you to schedule an appointment as soon as possible to have this repair performed.

## **DESCRIPTION OF THE SAFETY DEFECT**

Subaru has determined that your vehicle may have been manufactured with brake lines that could, over time, corrode if exposed to salt, such as salt used to treat roads in the winter time.

Depending on driving conditions, salt water could splash on the brake lines through a gap in the fuel tank protector, resulting in excessive corrosion of the lines. Excessive corrosion could eventually cause perforation of a brake line(s) resulting in a brake fluid leak.

*Continued...*

## DESCRIPTION OF THE SAFETY HAZARD

Your vehicle has a dual circuit braking system. Each circuit works independently and diagonally across the vehicle. If one circuit of the brake system fails, the other half of the system still works. Should a brake line corrode to the point of developing a perforation, brake fluid will leak from the line(s) causing the related circuit to eventually lose effectiveness. In this situation, there would be an increase in the amount of brake pedal travel distance and foot pressure required to slow or stop the vehicle. This might cause the driver to misjudge the amount of brake pedal travel required to achieve the desired stopping distance, increasing the risk of a crash.

## REPAIR

Subaru will inspect and test the current condition of the four-way connector area of your vehicle's brake lines. If it is found to be acceptable, anti-corrosion material will be applied to that area as a preventative measure. If it is found to be unacceptable, the brake lines will be replaced and anti-corrosion material will be applied to the new lines. These repairs will be performed at no cost to you.

## WHAT YOU SHOULD DO

You should contact your Subaru retailer (dealer) immediately for an appointment to have this repair performed.

There are several important precautions you should take until this repair has been performed:

- If you experience the condition described above while braking, continue to apply steady pressure on the brake pedal until the vehicle comes to a stop. Immediately contact your Subaru retailer for assistance.
- If you notice fluid leaking from the vehicle, do not operate the vehicle. Immediately contact your Subaru retailer for assistance.
- If the brake system warning light remains illuminated on the instrument panel with the parking brake fully released, do not operate the vehicle. Immediately contact your Subaru retailer for assistance.
- Always maintain a safe distance from other vehicles while driving. The normally recommended minimum distance is one car length of space for every 10 mph of speed.
- As a precautionary measure, it is highly recommended that you use extra care while operating the vehicle in confined areas such as parking lots and while parking your vehicle in a garage, car port or other structure.

## HOW LONG WILL THE REPAIR TAKE?

The time to inspect the brake lines and apply anti-corrosion material is approximately 12 minutes. If it is determined that the brake lines require replacement, the total estimated repair time is 6 hours. However, it may be necessary to leave your vehicle for a longer period of time on the day of your scheduled appointment to allow your Subaru retailer flexibility in scheduling. Please present this letter to your Subaru retailer at the time this repair procedure is performed.

## IF YOU HAVE PREVIOUSLY PAID FOR A REPAIR

If you have already paid for repairs associated with this condition, you may be eligible for reimbursement. Reimbursement consideration will be based on the amount an authorized Subaru retailer in your area would charge for the same repair.

Please send the original service repair order, which has the name of the repair facility, date of repair, mileage at the time of repair, complete 17-digit vehicle identification number (VIN), and your name, with correct mailing address and telephone number to the address listed below.

**Subaru of America, Inc.**  
**Customer-Retailer Services Department, Attention: WQQ-52 Recall**  
**P.O. Box 6000, Cherry Hill, NJ 08034-6000**

Please send original receipts only and retain a photocopy for your records. Please be assured that we will attempt to process your reimbursement request as quickly as possible, but it may take up to 60 days for this process to be completed.

*Continued...*

## CHANGED YOUR ADDRESS OR SOLD YOUR SUBARU?

If you have moved or sold your vehicle, please complete the enclosed prepaid postcard and mail it to us.

### IF YOU NEED FURTHER ASSISTANCE:

To locate the nearest Subaru retailer you can access our website at [www.subaru.com](http://www.subaru.com) and select "Find a Retailer."

For additional information and the most Frequently Asked Questions, please go to:

- <http://www.wqq52.service-campaign.com>

If you need additional assistance, please contact us directly:

- By e-mail: Go to [www.subaru.com](http://www.subaru.com) and select "Contact Us"
- By telephone: 1-800-SUBARU3 (1-800-782-2783)  
Monday through Thursday between 7:30 a.m. and 8:00 p.m. ET  
Friday between 10:30 a.m. and 5:00 p.m. ET  
Saturday between 9:00 a.m. and 3:30 p.m. ET
- By U.S. Postal mail: Write us at  
Subaru of America, Inc.,  
Attn: Customer-Retailer Services Department,  
P.O. Box 6000, Cherry Hill, NJ 08034-6000

Please contact us immediately if the Subaru retailer fails or is unable to make the necessary repairs free of charge.

You may also contact the Administrator, National Highway Traffic Safety Administration, 1200 New Jersey Ave. SE, West Building, Washington, DC 20590 or call the toll free Auto Safety Hotline at 1-888-327-4236 (TTY: 1-800-424-9153) or go to <http://www.safercar.gov> if you believe the Subaru retailer has failed or is unable to remedy your vehicle without charge within a reasonable amount of time.

Your continued satisfaction with your Subaru is important to us. Please understand that we have taken this action in the interest of your safety and your vehicle's proper operation. We sincerely apologize for any inconvenience this matter may cause and urge you to schedule an appointment as soon as possible to have this repair performed.

Sincerely,  
Subaru of America, Inc.

**Notice to Lessors:** Under Federal law the lessor of a vehicle who receives this letter must provide a copy of it to the vehicle lessee(s) within 10 business days from receipt. The lessor must also keep a record of the lessee(s) to whom this letter is sent, the date sent, and the applicable vehicle identification number (VIN). (For the purposes of this section, a lessor means a person or entity that in the last twelve months prior to the date of this notification has been the owner, as referenced on the vehicle's title, of any five or more leased vehicles. A leased vehicle is a vehicle leased to another person for a term of at least four months.)

***A subsidiary of Fuji Heavy Industries Ltd.***



# SAFETY DATA SHEET

## 1. Identification

**Product identifier** NOX-RUST 712AM

### Other means of identification

**SDS number** 140017

**Recommended use** Rust preventing oil.

**Recommended restrictions** None known.

### Manufacturer / Importer / Supplier / Distributor information

**Supplier** Parker Industries, Inc.

**Address** 15-1, Nihonbashi 1-chome, Chuo-ku, Tokyo 103-0027 JAPAN

**Telephone** +81 (3) 5205-1971

**Contact person** Noriharu Tanaka

**e-mail** ntanaka@parkerind.co.jp

**Emergency phone number** +81-47-431-3598

## 2. Hazard(s) identification

**Physical hazards** Not classified.

**Health hazards** Not classified.

**Environmental hazards** Not classified.

**OSHA defined hazards** Not classified.

### Label elements

**Hazard symbol** None.

**Signal word** Not available.

**Hazard statement** Not available.

### Precautionary statement

**Prevention** Observe good industrial hygiene practices.

**Response** Wash skin with soap and water.

**Storage** Store in a closed container.

**Disposal** Dispose of waste and residues in accordance with local authority requirements.

**Hazard(s) not otherwise classified (HNOC)** None known.

## 3. Composition/information on ingredients

### Mixtures

Chemical name	CAS number	%
Mineral oil	Proprietary	<60
Rust preventive additive	Proprietary	<10

**Composition comments** All concentrations are in percent by weight unless ingredient is a gas. Gas concentrations are in percent by volume.

## 4. First-aid measures

**Inhalation** Move to fresh air. Get medical attention if any discomfort continues.

**Skin contact** Rinse with water. Get medical attention if irritation persists after washing.

**Eye contact** Rinse the eye with water immediately. Get medical attention if irritation develops and persists.

**Ingestion** Rinse mouth thoroughly. Get medical attention if any discomfort continues.

**Most important symptoms/effects, acute and delayed** Prolonged contact may cause dryness of the skin.

**Indication of immediate medical attention and special treatment needed** Treat symptomatically.

**General information** First aid personnel must be aware of own risk during rescue.

## 5. Fire-fighting measures

<b>Suitable extinguishing media</b>	Use fire-extinguishing media appropriate for surrounding materials.
<b>Unsuitable extinguishing media</b>	None known.
<b>Specific hazards arising from the chemical</b>	By heating and fire, toxic vapors/gases may be formed.
<b>Special protective equipment and precautions for firefighters</b>	Selection of respiratory protection for firefighting: follow the general fire precautions indicated in the workplace. Self-contained breathing apparatus and full protective clothing must be worn in case of fire.
<b>Fire-fighting equipment/instructions</b>	Use standard firefighting procedures and consider the hazards of other involved materials. Prevent runoff from fire control or dilution from entering streams, sewers, or drinking water supply.
<b>General fire hazards</b>	Will burn if involved in a fire.

## 6. Accidental release measures

<b>Personal precautions, protective equipment and emergency procedures</b>	Wear suitable protective clothing, gloves and eye/face protection. Avoid prolonged and repeated contact.
<b>Methods and materials for containment and cleaning up</b>	Absorb spillage with suitable absorbent material.
<b>Environmental precautions</b>	Avoid discharge into drains, water courses or onto the ground.

## 7. Handling and storage

<b>Precautions for safe handling</b>	Avoid prolonged and repeated contact. Observe good industrial hygiene practices.
<b>Conditions for safe storage, including any incompatibilities</b>	Store in a well-ventilated place. Keep container tightly closed. Store away from incompatible materials.

## 8. Exposure controls/personal protection

### Occupational exposure limits

#### US. OSHA Table Z-1 Limits for Air Contaminants (29 CFR 1910.1000)

Components	Type	Value	Form
Mineral oil (CAS Proprietary)	PEL	5 mg/m3	Mist.
Rust preventive additive (CAS Proprietary)	PEL	5 mg/m3	Respirable fraction.
		15 mg/m3	Total dust.

#### US. ACGIH Threshold Limit Values

Components	Type	Value	Form
Mineral oil (CAS Proprietary)	TWA	5 mg/m3	Inhalable fraction.

#### US. NIOSH: Pocket Guide to Chemical Hazards

Components	Type	Value	Form
Mineral oil (CAS Proprietary)	STEL	10 mg/m3	Mist.
	TWA	5 mg/m3	Mist.
Rust preventive additive (CAS Proprietary)	TWA	5 mg/m3	Respirable.
		10 mg/m3	Total

<b>Biological limit values</b>	No biological exposure limits noted for the ingredient(s).
<b>Appropriate engineering controls</b>	Provide adequate ventilation. Observe occupational exposure limits and minimize the risk of inhalation of vapors and mist.
<b>Individual protection measures, such as personal protective equipment</b>	
<b>Eye/face protection</b>	Risk of splashes: Wear approved safety goggles.
<b>Skin protection</b>	
<b>Hand protection</b>	For prolonged or repeated skin contact use suitable protective gloves.
<b>Other</b>	Wear appropriate clothing to prevent repeated or prolonged skin contact.
<b>Respiratory protection</b>	In case of inadequate ventilation or risk of inhalation of oil mist, suitable respiratory equipment with particulate filter and organic vapor cartridges can be used.
<b>Thermal hazards</b>	Wear appropriate thermal protective clothing, when necessary.

*Continued...*

**General hygiene considerations** Always observe good personal hygiene measures, such as washing after handling the material and before eating, drinking, and/or smoking. Routinely wash work clothing and protective equipment to remove contaminants.

## 9. Physical and chemical properties

<b>Appearance</b>	Viscous liquid.
<b>Physical state</b>	Liquid.
<b>Form</b>	Viscous liquid.
<b>Color</b>	Yellowish brown.
<b>Odor</b>	Fatty. Oily.
<b>Odor threshold</b>	Not available.
<b>pH</b>	Not available.
<b>Melting point/freezing point</b>	Not available.
<b>Initial boiling point and boiling range</b>	> 482 °F (> 250 °C)
<b>Flash point</b>	> 410.0 °F (> 210.0 °C)
<b>Evaporation rate</b>	Not available.
<b>Flammability (solid, gas)</b>	Not applicable.
<b>Upper/lower flammability or explosive limits</b>	
<b>Flammability limit - lower (%)</b>	Not available.
<b>Flammability limit - upper (%)</b>	Not available.
<b>Vapor pressure</b>	Not available.
<b>Vapor density</b>	Not available.
<b>Relative density</b>	0.9 - 1
<b>Solubility(ies)</b>	
<b>Solubility (water)</b>	Not available.
<b>Partition coefficient (n-octanol/water)</b>	Not available.
<b>Auto-ignition temperature</b>	Not available.
<b>Decomposition temperature</b>	Not available.
<b>Viscosity</b>	1000 mPa·s (20 °C)

## 10. Stability and reactivity

<b>Reactivity</b>	The product is non-reactive under normal conditions of use, storage and transport.
<b>Chemical stability</b>	Stable under normal temperature conditions.
<b>Possibility of hazardous reactions</b>	Will not occur.
<b>Conditions to avoid</b>	Contact with incompatible materials.
<b>Incompatible materials</b>	Strong oxidizing agents.
<b>Hazardous decomposition products</b>	Carbon oxides. Sulfur dioxide. Nitrogen oxides. Calcium oxides.

## 11. Toxicological information

### Information on likely routes of exposure

<b>Ingestion</b>	May cause discomfort if swallowed.
<b>Inhalation</b>	Under normal conditions of intended use, this material is not expected to be an inhalation hazard.
<b>Skin contact</b>	Prolonged contact may cause dryness of the skin.
<b>Eye contact</b>	May cause temporary eye irritation. May cause redness and pain.

**Symptoms related to the physical, chemical and toxicological characteristics** Prolonged contact may cause dryness of the skin.

### Information on toxicological effects

<b>Acute toxicity</b>	May cause discomfort if swallowed.
-----------------------	------------------------------------

*Continued...*

Components	Species	Test Results
Rust preventive additive (CAS Proprietary)		
<b>Acute</b>		
<b>Oral</b>		
LD50	Mouse	6450 mg/kg
	Rat	6450 mg/kg
<b>Skin corrosion/irritation</b>	Prolonged contact may cause dryness of the skin.	
<b>Serious eye damage/eye irritation</b>	May cause temporary eye irritation. May cause redness and pain.	
<b>Respiratory or skin sensitization</b>		
<b>Respiratory sensitization</b>	No data available.	
<b>Skin sensitization</b>	No data available.	
<b>Germ cell mutagenicity</b>	No data available.	
<b>Carcinogenicity</b>	No data available.	
<b>Reproductive toxicity</b>	No data available.	
<b>Specific target organ toxicity - single exposure</b>	No data available.	
<b>Specific target organ toxicity - repeated exposure</b>	No data available.	
<b>Aspiration hazard</b>	No data available.	
<b>Chronic effects</b>	No data available.	
<b>12. Ecological information</b>		
<b>Ecotoxicity</b>	The product components are not classified as environmentally hazardous. However, this does not exclude the possibility that large or frequent spills can have a harmful or damaging effect on the environment.	
<b>Persistence and degradability</b>	No data available.	
<b>Bioaccumulative potential</b>	No data available.	
<b>Mobility in soil</b>	No data available.	
<b>Mobility in general</b>	No data available.	
<b>Other adverse effects</b>	No data available.	
<b>13. Disposal considerations</b>		
<b>Disposal instructions</b>	Dispose of in accordance with local regulations.	
<b>Hazardous waste code</b>	The waste code should be assigned in discussion between the user, the producer and the waste disposal company.	
<b>Waste from residues / unused products</b>	Dispose in accordance with all applicable regulations. Do not discharge into drains, water courses or onto the ground.	
<b>Contaminated packaging</b>	Since emptied containers may retain product residue, follow label warnings even after container is emptied.	
<b>14. Transport information</b>		
<b>DOT</b>		
	Not regulated as dangerous goods.	
<b>IATA</b>		
	Not regulated as dangerous goods.	
<b>IMDG</b>		
	Not regulated as dangerous goods.	
<b>Transport in bulk according to Annex II of MARPOL 73/78 and the IBC Code</b>	Not applicable.	
<b>15. Regulatory information</b>		
<b>US federal regulations</b>	This product is not known to be a "Hazardous Chemical" as defined by the OSHA Hazard Communication Standard, 29 CFR 1910.1200.	
<b>TSCA Section 12(b) Export Notification (40 CFR 707, Subpt. D)</b>		
	Not regulated.	
<b>US. OSHA Specifically Regulated Substances (29 CFR 1910.1001-1050)</b>		
	Not listed.	

**CERCLA Hazardous Substance List (40 CFR 302.4)**

Not listed.

**Superfund Amendments and Reauthorization Act of 1986 (SARA)**

**Hazard categories** Immediate Hazard - No  
Delayed Hazard - No  
Fire Hazard - No  
Pressure Hazard - No  
Reactivity Hazard - No

**SARA 302 Extremely hazardous substance**

Not listed.

**SARA 311/312 Hazardous chemical** No

**SARA 313 (TRI reporting)**  
Not regulated.

**Other federal regulations**

**Clean Air Act (CAA) Section 112 Hazardous Air Pollutants (HAPs) List**

Not regulated.

**Clean Air Act (CAA) Section 112(r) Accidental Release Prevention (40 CFR 68.130)**

Not regulated.

**Safe Drinking Water Act (SDWA)** Not regulated.

**US state regulations**

**US. Massachusetts RTK - Substance List**

Mineral oil (CAS Proprietary)  
Rust preventive additive (CAS Proprietary)

**US. New Jersey Worker and Community Right-to-Know Act**

Mineral oil (CAS Proprietary)  
Rust preventive additive (CAS Proprietary)

**US. Pennsylvania Worker and Community Right-to-Know Law**

Rust preventive additive (CAS Proprietary)

**US. Rhode Island RTK**

Not regulated.

**US. California Proposition 65**

California Safe Drinking Water and Toxic Enforcement Act of 1986 (Proposition 65): This material is not known to contain any chemicals currently listed as carcinogens or reproductive toxins.

**US - California Proposition 65 - Carcinogens & Reproductive Toxicity (CRT): Listed substance**

Not listed.

**International Inventories**

Country(s) or region	Inventory name	On inventory (yes/no)*
Australia	Australian Inventory of Chemical Substances (AICS)	Yes
Canada	Domestic Substances List (DSL)	Yes
Canada	Non-Domestic Substances List (NDSL)	No
China	Inventory of Existing Chemical Substances in China (IECSC)	Yes
Korea	Existing Chemicals List (ECL)	Yes
New Zealand	New Zealand Inventory	Yes
United States & Puerto Rico	Toxic Substances Control Act (TSCA) Inventory	Yes

\*A "Yes" indicates this product complies with the inventory requirements administered by the governing country(s).

A "No" indicates that one or more components of the product are not listed or exempt from listing on the inventory administered by the governing country(s).

**16. Other information, including date of preparation or last revision**

**Issue date** 06-March-2014  
**Revision date** -  
**Version #** 01

*Continued...*

**NFPA Ratings**

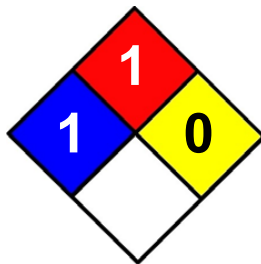

**Disclaimer**

This information is provided without warranty. The information is believed to be correct. This information should be used to make an independent determination of the methods to safeguard workers and the environment.