

**ATTENTION:**

- GENERAL MANAGER
- PARTS MANAGER
- CLAIMS PERSONNEL
- SERVICE MANAGER

IMPORTANT - All Service Personnel Should Read and Initial in the boxes provided, right.



QUALITY DRIVEN® SERVICE

**PRODUCT CAMPAIGN BULLETIN**

**APPLICABILITY:** 2005-2009 Subaru Legacy and Outback  
 2009-2013 Subaru Forester  
 2008-2011 Subaru Impreza, WRX, and STI  
 2012-2014 Subaru WRX and STI

**NUMBER:** WQK-47R  
**DATE:** July 2014  
**REVISED:** July 29, 2014  
**NHTSA ID:** 14V-311

**SUBJECT:** Brake Line Corrosion

Subaru of America, Inc. (SOA) has determined that a defect, which relates to motor vehicle safety, exists on certain 2005-2009 model year Subaru Legacy and Outback vehicles, 2009-2013 Subaru Forester vehicles, 2008-2011 Subaru Impreza, WRX, and STI vehicles, and 2012-2014 Subaru WRX and STI vehicles currently or formerly registered in at least one of the “salt-belt” states listed below or in the District of Columbia.

Connecticut	Maine	New Hampshire	Vermont
Delaware	Maryland	New Jersey	West Virginia
District of Columbia	Massachusetts	New York	Wisconsin
Illinois	Michigan	Ohio	
Indiana	Minnesota	Pennsylvania	
Iowa	Missouri	Rhode Island	

These vehicles may have been manufactured with brake lines that could, over time, corrode in the area of the four-way joint connector or in the areas where there are no resin covers installed if exposed to salt, such as salt used to treat roads in the winter time. Excessive corrosion could eventually cause perforation of a brake line(s) resulting in a brake fluid leak.

Should a brake line corrode to the point of developing a perforation, brake fluid will leak from the line(s) causing the related circuit to eventually lose effectiveness. In this situation, there would be an increase in the amount of brake pedal travel distance and foot pressure required to slow or stop the vehicle. This might cause the driver to misjudge the amount of brake pedal travel required to achieve the desired stopping distance, increasing the risk of a crash.

This recall will involve cleaning, inspecting and testing the brake lines for perforation. If no leaks are found, as a preventative measure it will be necessary to apply an anti-corrosion material to the areas of concern. If any of the brake lines are found to be leaking, all four brake lines on the vehicle will require replacement.

**AFFECTED VEHICLES**

The affected vehicles include certain: 2005-2009 model year Subaru Legacy and Outback vehicles; 2009-2013 Subaru Forester vehicles; 2008-2011 Subaru Impreza, WRX, and STI vehicles; and 2012-2014 Subaru WRX and STI vehicles currently or formerly registered in at least one of the “salt-belt” states or the District of Columbia.

Affected vehicles are identified in the VIN range charts below. **NOTE:** Not all vehicles within the VIN ranges are affected. Coverage for all affected vehicles must be confirmed by using the Vehicle Coverage Inquiry function on [subarunet.com](http://subarunet.com).

*Continued...*

<b>MODEL</b>	<b>MY</b>	<b>CARLINE(S)</b>	<b>START VIN (last 8 digits)</b>	<b>END VIN (last 8 digits)</b>
<b>Legacy &amp; Outback</b>	2005	Legacy & Outback	5*200001	5*393924
	2006	Legacy & Outback	6*200001	6*364201
	2007	Legacy & Outback	7*200001	7*346352
	2008	Legacy & Outback	8*200001	8*367431
	2009	Legacy & Outback	9*200001	9*348625
<b>Forester</b>	2009	Forester	9*700001	9*797855
	2010	Forester	A*700001	A*918317
	2011	Forester	B*700001	B*783898
	2012	Forester	C*400001	C*470750
	2013	Forester	D*400001	D*446782
<b>Impreza</b>	2008	4 -Door (except STI)	8*500001	8*530288
	2008	5 -Door (except STI)	8*800001	8*838495
	2008	5 -Door (STI)	8L809673	8L837138
	2009	4 -Door (except STI)	9*500001	9*522884
	2009	5 -Door (except STI)	9*800001	9*828092
	2009	5 -Door (STI)	9L800020	9L828023
	2010	4 -Door (except STI)	A*500001	A*517646
	2010	5 -Door (except STI)	A*800001	A*828797
	2010	5 -Door (STI)	AL800010	AL826680
	2011	4 -Door (except WRX and STI)	B*500001	B*523841
	2011	5 -Door (except WRX and STI)	B*800001	B*832332
	2011	4 -Door (WRX and STI)	B*500742	B*525817
	2011	5 -Door (WRX and STI)	B*801433	B*833719
	2012	4 -Door (WRX and STI)	C*002099	C*031281
	2012	5 -Door (WRX and STI)	C*200094	C*246471
	2013	4 -Door (WRX and STI)	D*002007	D*035278
	2013	5 -Door (WRX and STI)	D*200100	D*895579
	2014	4 -Door (WRX and STI)	E*002001	E*016827
	2014	5 -Door (WRX and STI)	E*200001	E*270263

\*Various characters may occupy this position of the VIN.

*Continued...*

## **THIS RECALL REPLACES AND UPDATES ANY PREVIOUS ‘WQG-43’ BRAKE LINE CORROSION RECALL-RELATED REPAIRS PERFORMED**

This recall replaces and updates SOA’s previous WQG-43 brake line corrosion recall applicable to some 2005-2009 Legacy and Outback models, issued in May of 2013. In addition to the repair procedure of the previous WQG-43 recall, this recall includes inspection and treatment of other areas of the brake lines.

As a result, any incomplete WQG-43 recall applicability will be expired in SOA’s system at the time WQK-47 affected vehicle data is loaded. Coverage for all affected vehicles must be confirmed by using the Vehicle Coverage Inquiry function on [subarunet.com](http://subarunet.com).

***IMPORTANT NOTE: If the WQG-43 brake line corrosion recall repair was already performed, the WQK-47 recall repair must also be performed to ensure that all affected areas of the brake lines are acceptable and treated with anti-corrosion material as a preventative measure.***

### **OWNER NOTIFICATION**

Notification letters will be sent to owners of vehicles that are currently or were previously registered in at least one of the “salt-belt” states or the District of Columbia. Owner notification will begin on July 21, 2014.

To ensure sufficient supply of materials and parts, and to accommodate appointment scheduling at the retailer level, a phased mailing schedule will be implemented as follows:

- Owners of affected 2005-2009 Legacy and Outback vehicles will be notified to schedule an appointment with their Subaru retailer to have this repair performed.
- Owners of affected Forester, Impreza, WRX, and STI vehicles will be notified that their vehicle is affected by this recall and when sufficient materials and parts are available, they will be notified again.
- As sufficient materials and parts become available, owners of affected Forester, Impreza, WRX, and STI vehicles will be notified to schedule an appointment with their Subaru retailer to have this repair performed. This second notification process will be based on vehicle age and affected vehicle volumes.

Copies of the Owner Notification Letters are included at the end of this bulletin.

### **OWNERS LOCATED OUTSIDE THE AFFECTED “SALT-BELT” STATES**

Notification letters will only be mailed to owners of vehicles that are currently registered or were previously registered in at least one of the “salt-belt” states or the District of Columbia.

However, there are circumstances under which vehicles that were not previously or ever registered in a “salt-belt” state will be covered by this recall campaign. These circumstances may include:

*Continued...*

1. Vehicles not currently or previously registered in a “salt-belt” state that have relocated into a “salt-belt” area and/or vehicles registered in a “non-salt belt” state, and driven in a “salt-belt” area: We request that retailers located in “salt-belt” states check all vehicles within the affected VIN range for recall coverage. If it is determined the owner of a vehicle within the affected VIN range relocates or uses his or her vehicle in a “salt-belt” area, the retailer should perform the recall procedure.
2. Vehicles in “non-salt belt” states that have experienced the defect: In the unlikely event an owner in a “non-salt belt” state experiences the defect or otherwise requests the procedure be performed on their vehicle, the retailer should perform the recall procedure. This applies to both “salt-belt” and “non-salt belt” state retailers.

Under such circumstances, the Subaru retailer should perform the recall procedure at no cost to the customer. For claim submission, please contact the Warranty Helpdesk at (1-866-SUBARU2) 1-866-782-2782 to have the VIN added to the recall.

## **RETAILER AFFECTED VIN LISTS**

Each Subaru retailer will receive an affected VIN list from their Zone office around the time initial owner notification begins. Vehicles will be assigned to retailers in the affected VIN list as follows:

- Original vehicle owners are assigned to the original selling retailer when their current address is within a 100 mile radius of that retailer.
- If the original selling retailer is inactive, the VIN will be assigned to the nearest active retailer.
- For any new owners or when original owners live more than 100 miles from the original selling retailer, the VIN will be assigned to the nearest active retailer.

**Important: Retailer affected VIN lists include owner name and address information for vehicles affected by this recall. This information will enable retailers to follow-up with owners of potentially affected vehicles. The lists contain owners’ names and addresses obtained from State Motor Vehicle Registration Records. The use of such motor vehicle registration data for any other purpose is unlawful. Accordingly, retailers are urged to limit the use of these lists to the purpose of completion of this safety recall.**

## **SUBARU RETAILER PROGRAM RESPONSIBILITY**

Subaru retailers are to promptly perform the applicable service procedures defined in this bulletin to correct all affected vehicles in their inventory (new, used, demo & SSLP). Additionally, whenever a vehicle subject to this recall is taken into the retailer’s new or used inventory or into the retailer for service, necessary steps should be taken to ensure the recall correction has been made before selling or releasing the vehicle.

New, used, demo or SSLP (Subaru Service Loaner Program) vehicles listed in a recall/campaign that are in the retailer’s stock must be:

- Immediately identified

*Continued...*

- Tagged or otherwise marked to prevent their delivery or use prior to inspection and/or repair
- Repaired in accordance with the repair procedures outlined in this Product Campaign Bulletin.

**Please be advised that it is a violation of Federal law for a retailer to deliver a new motor vehicle covered by a recall under a sale or lease until the defect is remedied. Therefore, any authorized Subaru retailer failing to perform the applicable service procedures as defined in this bulletin to correct all affected vehicles in their inventory (new, used, demo & SSLP) prior to the vehicle being placed in service may be subject to civil penalties of up to \$7,000 per violation (e.g., for each vehicle), as provided in 49 CFR §578.6 and will also be in breach of the Subaru Dealer Agreement.**

## SPECIAL TOOLS INFORMATION

During the week of July 21, 2014, all retailers will receive one spray gun and one nozzle at no charge to perform this recall. Additional spray guns and nozzles will be available on a limited basis, therefore they will be on hold in the SOA Parts system. Please contact the Parts Information Coordinators at (1-866-SUBARU2) 1-866-782-2782 for additional information.

PART NUMBER	DESCRIPTION
SOA635134	WQK-47 Spray Gun (does not include nozzle)
SOA635135	WQK-47 Nozzle

## PARTS INFORMATION

The parts required for this recall are:

- Nox-Rust® 712AM rust-proofing material (for all affected vehicles)
- Self-locking nut kit (for all affected vehicles except Legacy and Outback).

### **Nox-Rust® 712AM Rust-proofing Material:**

Exposure Controls for use of Nox-Rust® 712AM: The Material Safety Data Sheet (MSDS) which provides storage and handling procedures for this product is included at the end of this bulletin.

The WQK-47 rust-proofing material comes in one liter bottles, packed in a case of 10 bottles. **Each one liter bottle contains enough material to treat 9 vehicles.**

During the week of July 21, 2014, retailers located in the “salt-belt” states will automatically be shipped one case (10 bottles) of rust-proofing material. This will provide enough material to treat 90 vehicles. It will be necessary for retailers located outside of affected “salt-belt” states to order rust-proofing material as needed.

Additional quantities of the rust-proofing material will be available through the “Genuine Subaru Automotive Chemical” program starting the week of July 28, 2014. In order to maintain an adequate part supply, SOA requests retailers only order quantities necessary to satisfy anticipated demand.

*Continued...*

For parts ordering purposes, retailers should use the part number listed below. Each case contains 10 bottles. The part number listed below is for one bottle, however retailers must order in case quantities of 10.

ORDERING PART NUMBER	APPLICABILITY	DESCRIPTION	CASE/ ORDER QUANTITY
SOA868V9390	All models	Nox-Rust® 712AM (one liter bottle) – 9 repairs	10

For claim reimbursement purposes, retailers should use the part number listed below which represents rust proofing materials sufficient for one vehicle application.

CLAIM PART NUMBER	APPLICABILITY	DESCRIPTION	CLAIM QUANTITY
SOA635133	All models	Nox-Rust® 712AM Rust-proofing material – one repair (for claim purposes only)	1

**Self-locking Nut Kit – required for Impreza, WRX, STI, and Forester models only:**

The WQK-47 self-locking nut kit contains two self-locking nuts needed when this recall repair is performed on Impreza, WRX, STI, and Forester vehicles. Replacement of the two self-locking nuts to secure the passenger side (right-hand) fuel tank cover will be necessary, as the nuts removed during the repair are one-time use items and not reusable. **NOTE:** If brake piping replacement is determined to be necessary on Impreza and Forester vehicles, two of the self-locking nut kits (4 nuts total) will be required when reinstalling the fuel tank covers.

The WQK-47 self-locking nut kit is **not** needed for repairs performed on Legacy and Outback vehicles.

During the week of July 21, 2014, retailers located in affected “salt-belt” states will automatically be shipped 50 self-locking nut kits. This provides enough self-locking nut kits for the inspection of 50 vehicles. It will be necessary for retailers located outside of affected “salt-belt” states to order self-locking nut kits as needed.

Additional quantities of the WQK-47 self-locking nut kits will be available through normal parts ordering channels starting the week of July 28, 2014. In order to maintain an adequate part supply, SOA requests retailers only order quantities necessary to satisfy anticipated demand.

For parts ordering and claim purposes, retailers should use the part number listed below.

PART NUMBER	APPLICABILITY	DESCRIPTION	QUANTITY
42009FG000	Impreza, WRX, STI, and Forester	WQK-47 Self Lock Nut Kit (contains two self-locking nuts)	1

**Note:** SOA will only notify owners of vehicles that are currently or were previously registered in at least one of the “salt-belt” states or the District of Columbia. In cases where the vehicle was previously registered in a “salt-belt” state or the District of Columbia, it will be necessary for retailers located outside of the “salt-belt” area to order materials and parts to service those affected vehicles if they come to their Service Department for this repair.

***Continued...***

## SERVICE PROCEDURE

This Campaign involves a close inspection of the steel brake pipes located in the fuel tank area of the vehicle. Corrosion may develop in areas of these brake pipes not protected by a resin cover and eventually perforate them causing brake fluid seepage. If seepage is verified during the inspection procedures, the affected brake piping must be replaced. If no seepage is verified, application of a protective rustproofing wax material to specific sections of the brake piping will be required to complete this Campaign. On Legacy and Outback models, the inspection and rustproofing procedures are all performed through the inspection cover opening on the right-hand (passenger side) of the plastic fuel tank cover. On Impreza and Forester models, the right-hand (passenger side) portion of the plastic fuel tank cover must be removed for access. The following illustrations provide an overview of the affected areas.

### 2005-2009 Legacy and Outback

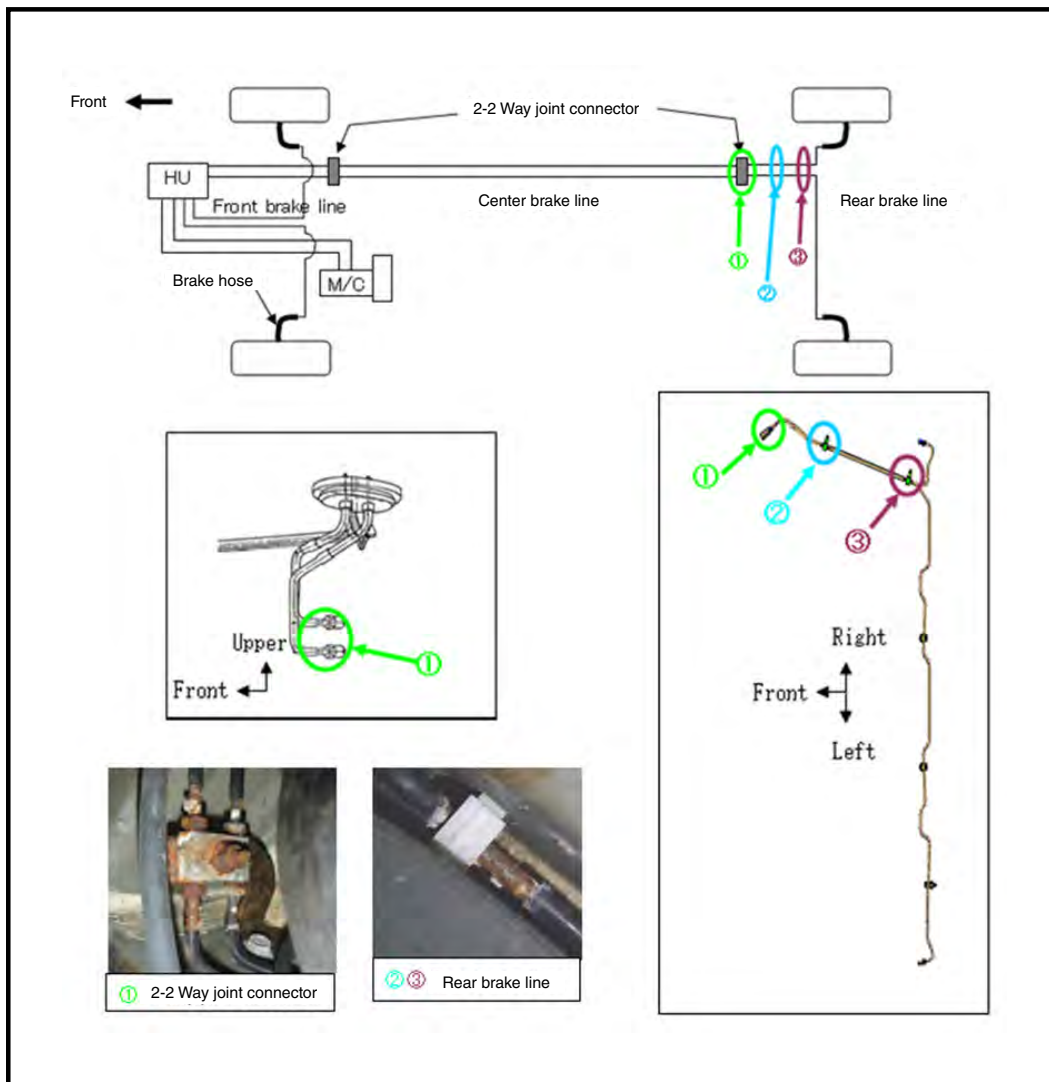

*Continued...*



# Impreza, WRX, STI, Forester

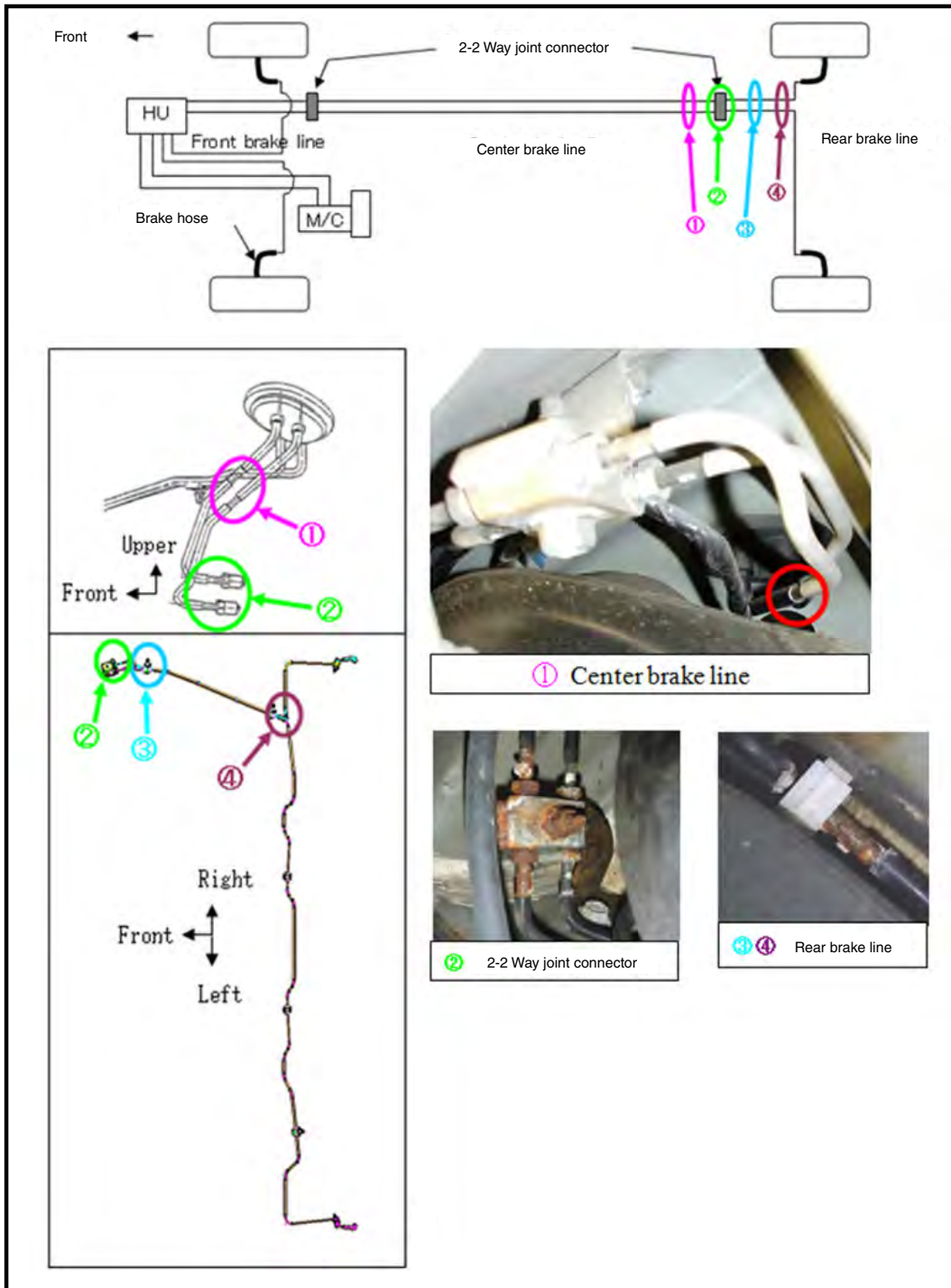

*Continued...*



## INDEX

1. Required Tools (Pg.9)
2. Spray Gun: Assembling, Adjusting and Cleaning (Pg.9)
3. WQK-47 Service Procedure Flow Chart (Pg.13)
4. **[Step 1]** Brake Fluid Leakage Inspection #1: Visual Check (Pg.14)
5. **[Step 2]** Brake Fluid Leakage Inspection #2: With Brake Pedal Depressed (Pg.18)
6. **[Step 3]** Application of Rust-Proofing (Pg.21)
7. **[Step 4]** Brake Piping Replacement (Pg.27)

### 1. REQUIRED TOOLS AND MATERIALS

DESCRIPTION	BRAND OR TYPE	QUANTITY
Safety Goggles	—	1 pair
Particle Mask	—	1
Shop Cloths	—	As Needed
Air Compressor	—	1
Air Gun	—	1
Twin Post Lift	—	1
Screwdriver (Flat Blade)	—	1
Flashlight	—	1
Tape Measure	—	1
Toothbrush	—	1
Spray Gun	Part Description: WQK-47 Spray Gun (Part Number: SOA635134)	1
<b>In-Line Air Pressure Regulator</b>	—	<b>As Needed</b>
Nozzle	Part Description: WQK-47 Nozzle (Part Number: SOA635135)	1
Anti-Rust Wax	Part Description: NOX-RUST 712AM (Part Number: SOA868V9390)	As much as required
Kerosene	—	As Needed

### 2. SPRAY GUN: ASSEMBLING, ADJUSTING AND CLEANING

#### **CAUTION:**

- **All retailers are reminded to read the entire campaign bulletin BEFORE assembling and operating the spray gun. Note that the spray gun utilizes a pressurized cup for the wax.**
- **The spray gun cup is not designed for pressures higher than indicated in the campaign instructions.** Most standard shop air exceeds those pressure standards.
- **Always ensure that a properly regulated air supply is connected to prevent damage to the spray cup.** If you are unsure of the pressure from your shop air supply, an in-line regulator before the spray gun should be used. **Never exceed the listed pressures.**
- **Damage to the spray gun due to use in unspecified manner will require replacement of the entire spray gun assembly.**
- **Always check the spray gun for any damage prior to use. Do not use if damaged.**

*Continued...*



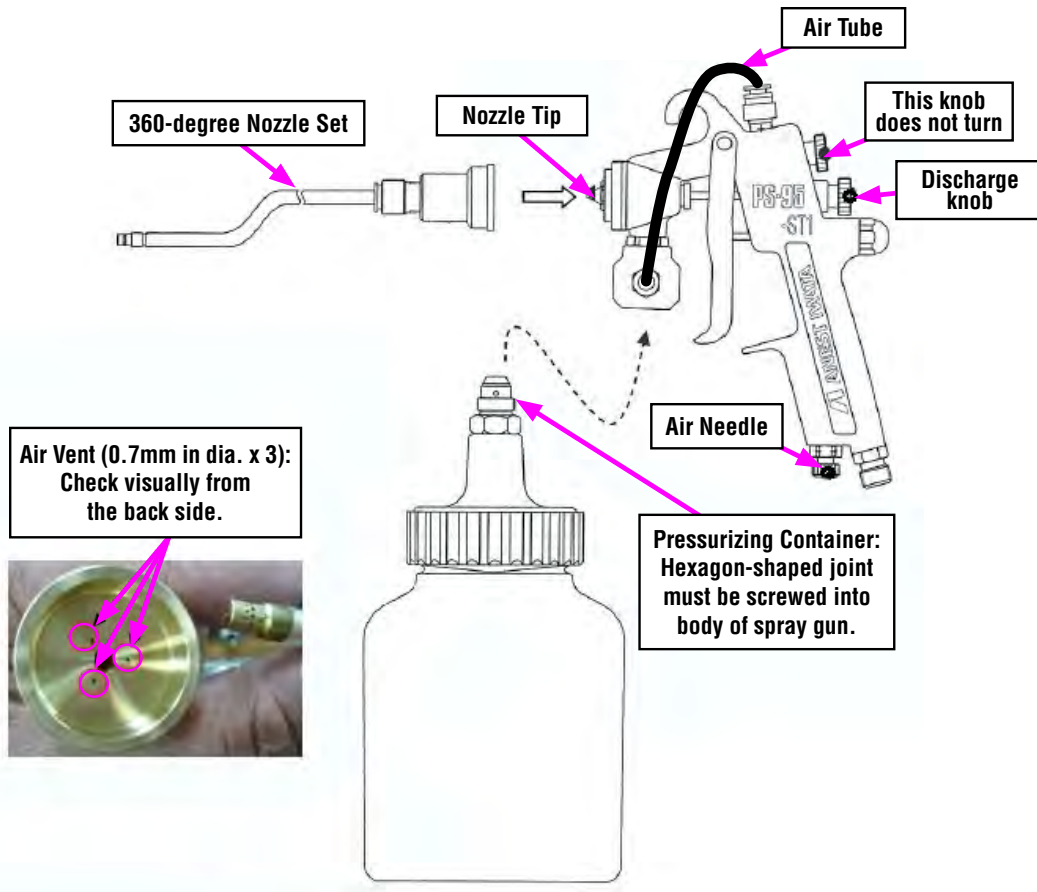

### (4-1) Assembling of Spray Gun:

**IMPORTANT:** Be careful not to damage or deform the nozzle tip.





### (4-2) Adjusting of Spray Gun:

#### A: Zero-point Setting of Discharge Knob and Air Needle

<b>Zero-point Setting of Discharge Knob</b>	
<p>a) Fully close by rotating the knob clockwise.</p>  <p style="text-align: center;">Discharge Knob</p>	<p>b) Mark the screw at stop (zero) point.</p>  <p style="text-align: center;">Zero-point Mark</p>
<b>Zero-point Setting of Air Needle</b>	
<p>a) Fully open by rotating the needle counter-clockwise.</p>  <p style="text-align: center;">Air Needle</p>	<p>b) Mark the screw at stopped (zero) point.</p>  <p style="text-align: center;">Zero-point Mark</p>

#### B: Adjustment of Wax Amount and Air Volume

Discharge Knob	<p>Opening state from full-close: Summer: 3/4 turn Winter: 4 turns</p> 
Air Needle	<p>Closing state from full-open: All seasons: 1 full turn</p> 
Compressor Air Pressure	<p>Summer: 51 PSI Winter: 71 PSI</p> <p><b>Never Exceed 71 PSI</b></p> 
Remarks	<p>The adjustments above are required as wax temperatures will change between summer and winter. Additional pressure adjustments may be needed to achieve the required results.</p>

*Continued...*

### (4-3) Cleaning Procedure for Spray Gun :

The wax material (712AM) used for WQK47 is easier to maintain compared with other common coating materials due to its extended “pot life” of 5-7 days. **However, once this wax solidifies, it is not soluble in solvent.** Please clean the spray gun at the end of each day’s work following the procedure below.

Close the discharge knob then clear the residual wax in nozzle with air pressure and wipe the tip clean.

**After operation**



**Residual wax visible inside nozzle**



**Insert nozzle into waste container and close the discharge knob.**

**Pull the gun trigger half way and hold for about 20 seconds until the tip is clear.**

**CAUTION: Always wear Safety Goggles and Particle Mask whenever discharging air through the sprayer as residual chemicals may remain.**



**Confirm the nozzle and tip are clear.**

**Wipe the tip with a clean cloth.**

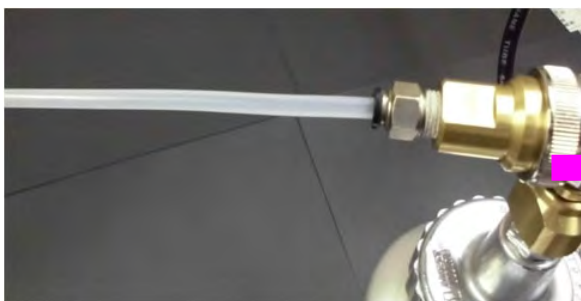

**IMPORTANT:** The cup does not need to be cleaned if additional vehicles are scheduled within the next few days as the wax has a pot life of 5-7 days **BUT**, the gun and nozzle must be cleaned **DAILY**.

*Continued...*

**Maintenance / Storage Procedure (for when the next operation is not scheduled within 5-7 days)**

In this case, clean the complete spray gun.  
Clean the nozzle, tip, gun and cup using kerosene.

**REMINDER:** This wax product does not dissolve in thinner.

**Remove the cup from the gun.**



**Return the remaining wax to the bottle.**



**Close the cap of the bottle tight.**



**DISCARD THE WAX IF IT SHOWS ANY SIGNS OF STARTING TO SOLIDIFY.**

**Clean the outside of the pipe.**



**Remove the lid of the cup from the gun.**



**Remove the remaining wax inside of the pipe.**

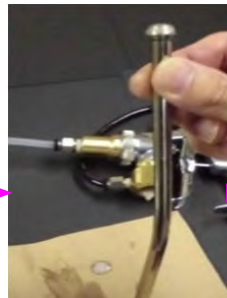

**Clean the inside of the cup.**



**Clean the mounting portion of the gun and the lid of the cup.**



**Remove and clean the tip of the gun.**

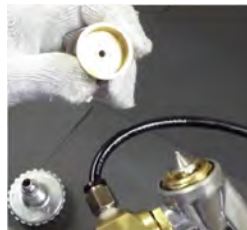

**Reassemble the spray gun then connect the compressed air supply.**

**Pour 8-10 oz. of kerosene in to the cup.**



**Flush the cup and gun by spraying the kerosene into the waste container.**



**Confirm the inside of the cup is clean.**



**CAUTION: Always wear protective Goggles and Particle Mask whenever air is discharged through the spray gun.**

To prevent damage to the gun and also the loss of parts after cleaning, it is recommended to always store the gun in its original box.

*Continued...*



### 3. WQK-47 SERVICE PROCEDURE FLOW CHART

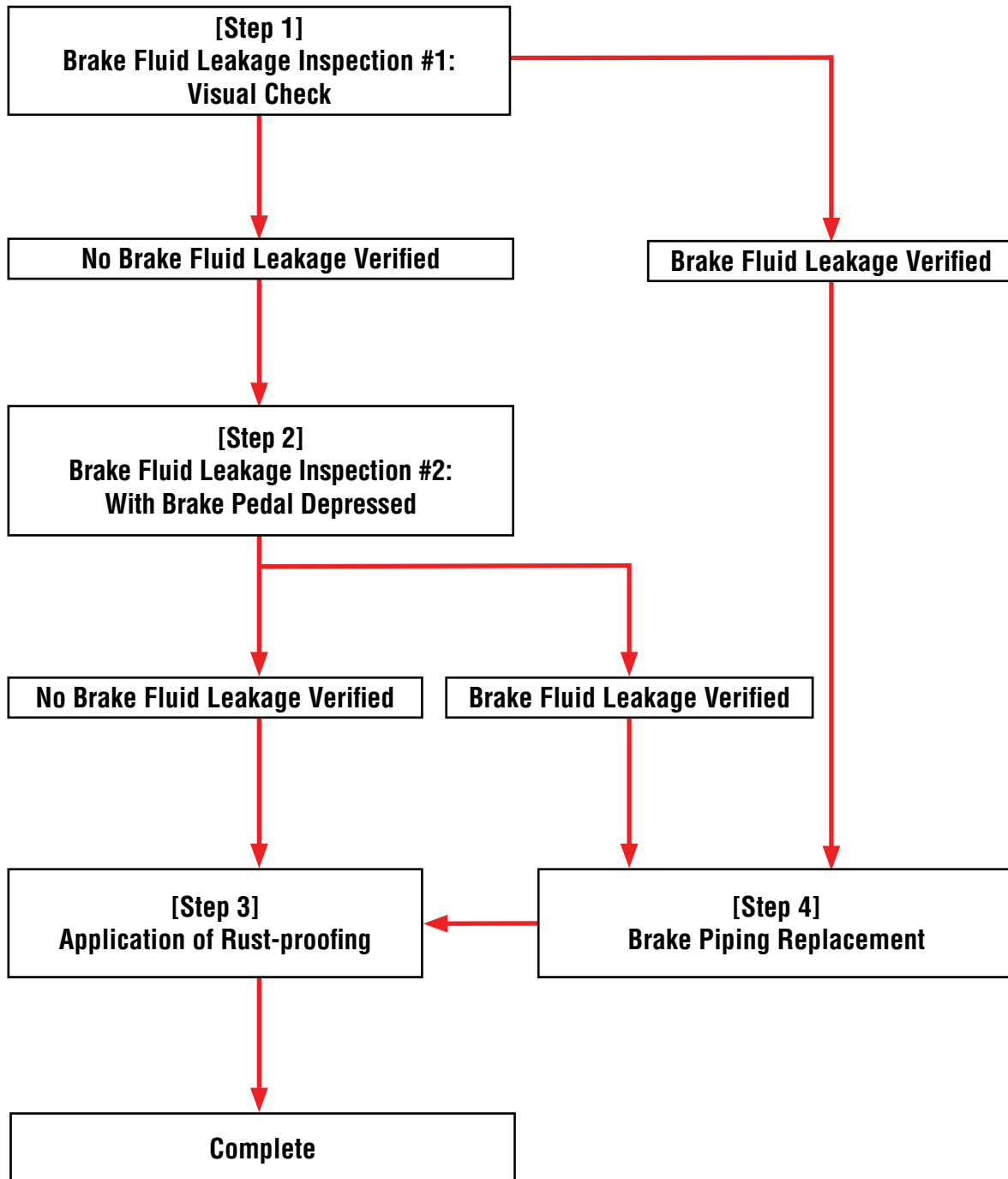

*Continued...*

#### 4. [STEP 1] BRAKE FLUID LEAKAGE INSPECTON #1: VISUAL CHECK

**FOR LEGACY AND OUTBACK VEHICLES** (for Impreza and Forester vehicles, proceed to Pg.15)

**IMPORTANT:** Be sure to wear safety goggles and mask.

(1) **Preparation: Raise the vehicle on a lift.**

(2) **Find the Location of Brake Pipes (With Plastic Inspection Cover Open)**

(2-1) Confirm the location of Brake Pipe Portion A around 2-2 Way Connector by opening inspection hole cover. (Photo 1 and A)

(2-2) Confirm the location of Brake Pipe Portion B and C through side gap of fuel tank cover. (Photo B and C)

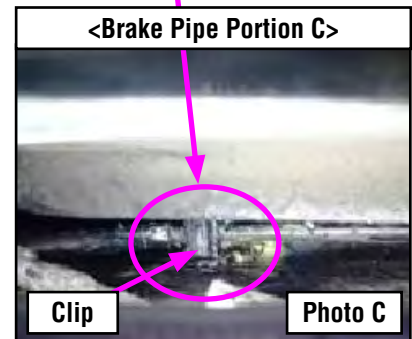
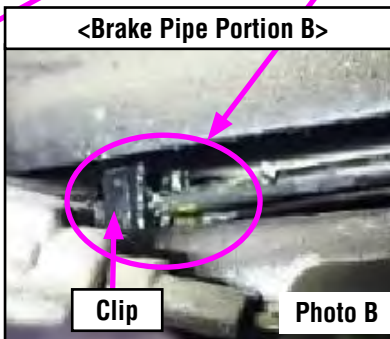
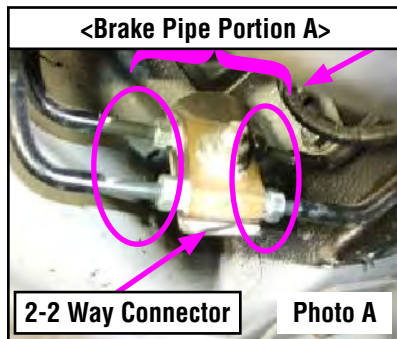
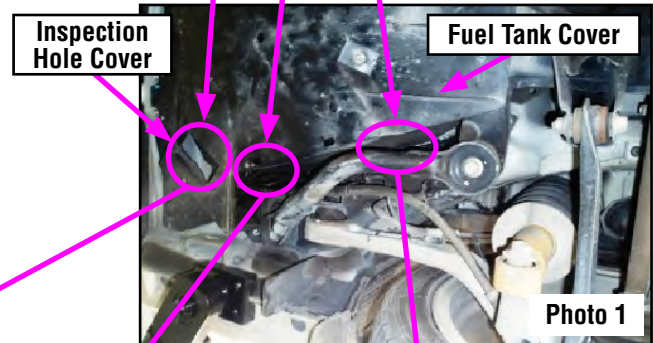
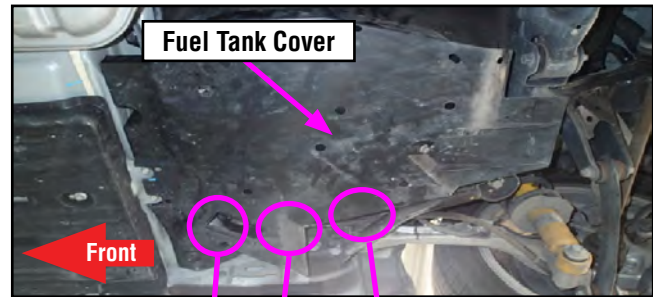

**IMPORTANT:** If brake piping is covered with water, snow, etc., blow it away with compressed air and dry completely before starting the inspection process.

(3) **Dust and Dirt Removal:**

(3-1) For Brake Pipe Portion A, use a tooth brush and compressed air to remove dust and dirt. (Photo 2)

**IMPORTANT: NEVER** use a metal / wire brush!

(3-2) For Brake Pipe Portion B and C, use compressed air to remove dust and dirt.

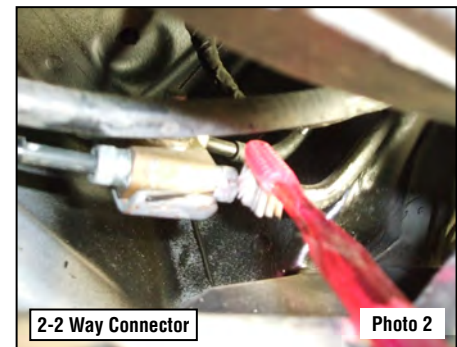

Be sure to **carefully** brush the brake piping to prevent damage.

*Continued...*

**(4) Visual Check:**

(4-1) Check for fluid leakage for Brake Pipe Portion A. (Photo A)

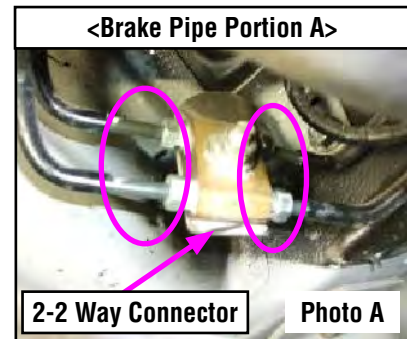

(4-2) Check for fluid leakage from Brake Pipe Portion B. (Photo B)

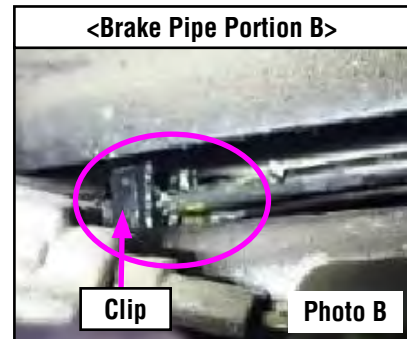

(4-3) Check for fluid leakage from Brake Pipe Portion C. (Photo C)

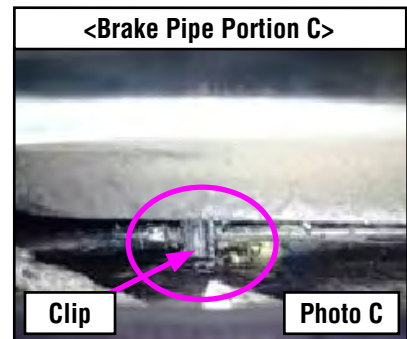

**(5) Determination of Required Repairs (for all vehicles):**

(5-1) If no brake fluid leakage is verified:  
Proceed to [Step 2] “**BRAKE FLUID LEAKAGE INSPECTION #2 WITH BRAKE PEDAL DEPRESSED**”.

(5-2) If brake fluid leakage is verified, Proceed to [Step 4] “**BRAKE PIPING REPLACEMENT**”.

**IMPORTANT:** The decision to replace brake piping should be made **ONLY** when brake fluid leakage is verified. Replacement of brake piping due to other reasons including surface rust is not a matter for warranty. Questions related to any out of warranty concerns should be directed to your DPSM.

**FOR IMPREZA AND FORESTER VEHICLES**

**(1) Preparation:**

(1-1) Raise the vehicle on a lift.

(1-2) Remove the fuel tank cover on the right (passenger) side of the vehicle.

**IMPORTANT:** The self-locking nuts are **one-time use** items and must be replaced.

*Continued...*



**(2) Identify the Affected Brake Piping After Removing the Plastic Cover:**

(2-1) Confirm the location of Brake Pipe Portion D in front of 2-2 Way Connector.  
(Photo D)

(2-2) Confirm the location of Brake Pipe Portion E around 2-2 Way Connector.  
(Photo E)

(2-3) Confirm the location of Brake Pipe Portion F in the rear of 2-2 Way Connector.  
(Photo F)

(2-4) Confirm the location of Brake Pipe Portion G through the side gap of fuel tank.  
(Photo G)

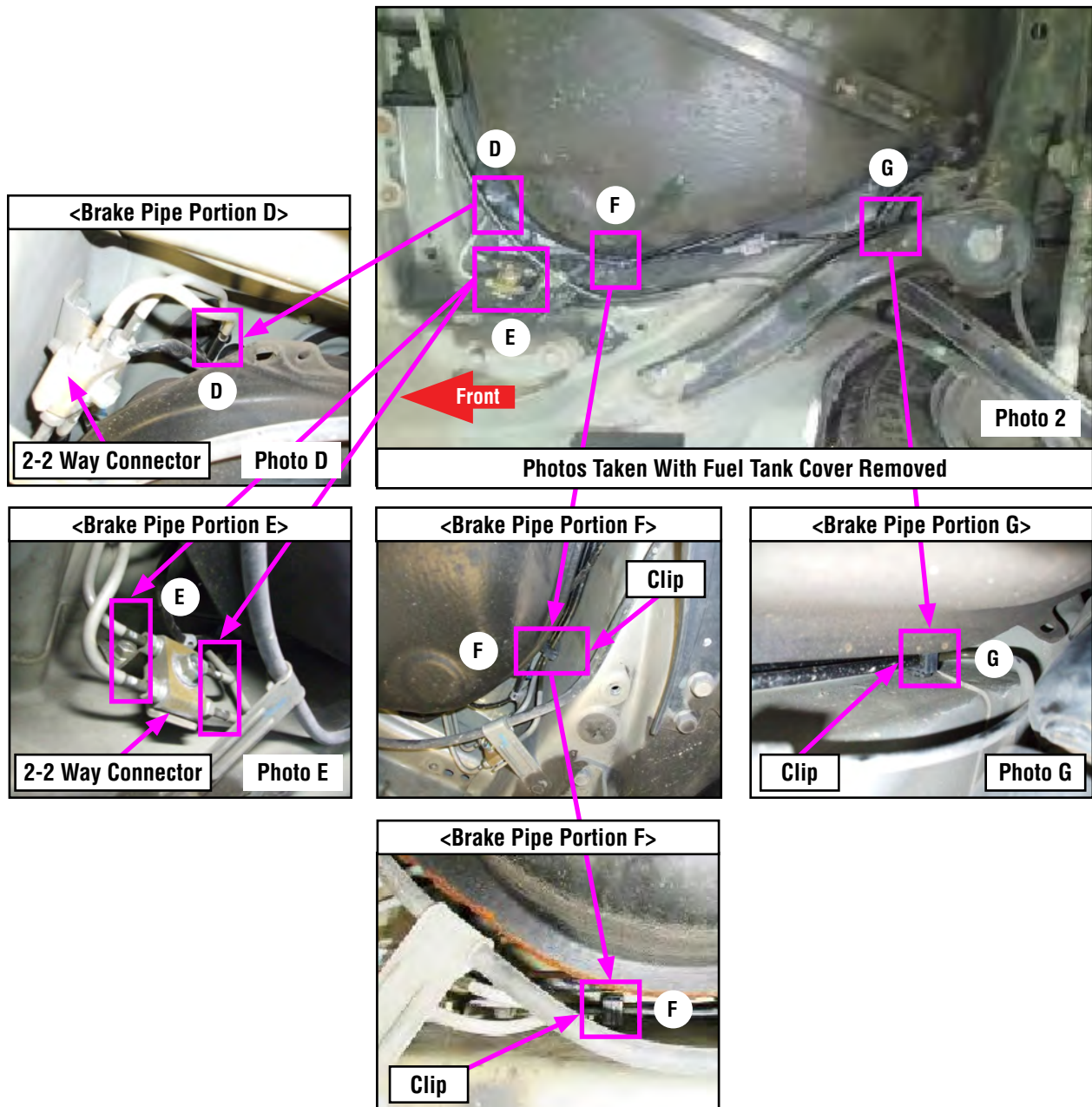

*Continued...*

**IMPORTANT:** If brake piping is covered with water, snow, etc., blow it away with compressed air and dry completely before starting the inspection process.

**(3) Dust and Dirt Removal:**

(3-1) For Brake Pipe Portion E, use a tooth brush and compressed air to remove dust and dirt. (Photo 3)

**IMPORTANT: NEVER** use a metal / wire brush!

(3-2) For Brake Pipe Portion D, F and G, use only compressed air to remove dust and dirt.

Be sure to **carefully** brush the brake piping to prevent damage.

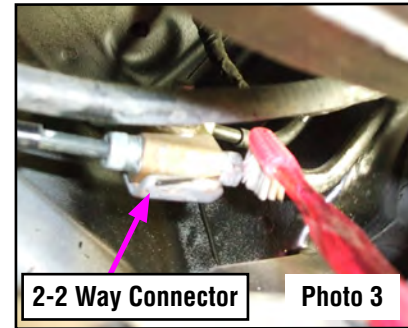

**(4) Visual Check:**

(4-1) Check for fluid leakage from Brake Pipe Portion D. (Photo D)

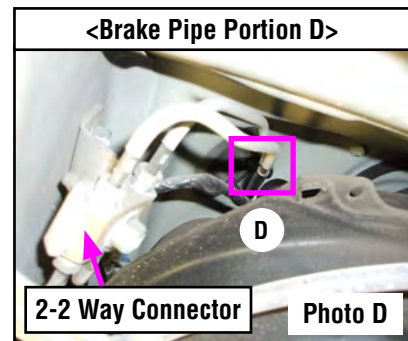

(4-2) Check for fluid leakage from Brake Pipe Portion E. (Photo E)

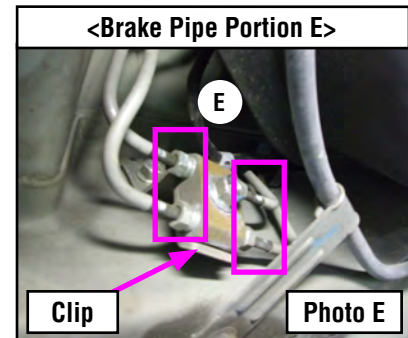

(4-2) Check for fluid leakage from Brake Pipe Portion F. (Photo F)

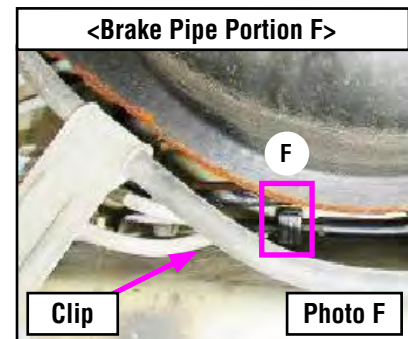

*Continued...*

(4-3) Check for fluid leakage from Brake Pipe Portion G. (Photo G)

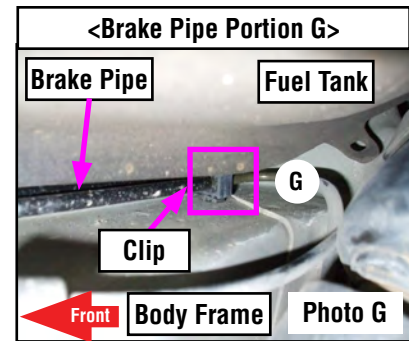

### (5) Determination of Required Repairs:

(5-1) If no brake fluid leakage is verified:

Proceed to [Step 2] “**BRAKE FLUID LEAKAGE INSPECTION #2 WITH BRAKE PEDAL DEPRESSED.**”

(5-2) If brake fluid leakage is verified:

Proceed to [Step 4] “**BRAKE PIPING REPLACEMENT.**”

**IMPORTANT:** The decision to replace brake piping should strictly be made **ONLY** when brake fluid leakage is verified. Replacement of brake piping due to other reasons including surface rust are not a matter for warranty. Questions related to any out of warranty concerns should be directed to your DPSM.

## 5. [Step 2] BRAKE FLUID LEAKAGE INSPECTION #2 WITH BRAKE PEDAL DEPRESSED (for all vehicles)

### (1) Preparation:

(1-1) Lower the vehicle.

### (2) Depressing Brake Pedal Procedure:

(2-1) Start the engine and allow it to idle.

(2-2) Measure dimension “L2” (foot off pedal) as shown in Drawing 2.

(2-3) Depress the brake pedal until the dimension from steering wheel to brake pedal “L1” becomes 110mm greater than dimension “L2”.

(2-4) Hold the brake pedal in that position for about 3 seconds.

(2-5) Shut off the engine.

(2-6) Raise the vehicle.

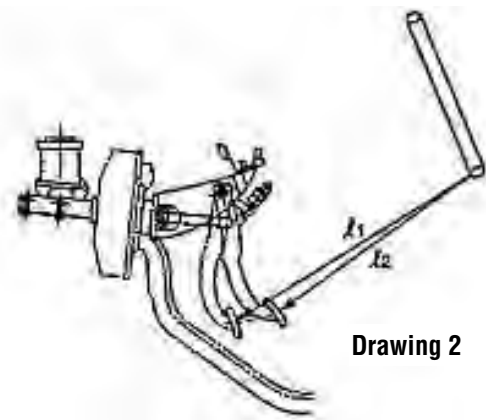

*Continued...*

**(3) Visual Inspection:**  
**FOR LEGACY AND OUTBACK VEHICLES**

(3-1) Check on fluid leakage from Brake Pipe Portion A. (Photo A)

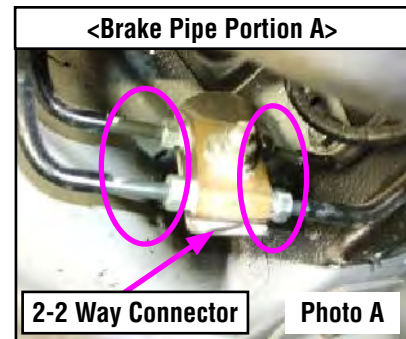

(3-2) Check for fluid leakage from Brake Pipe Portion B. (Photo B)

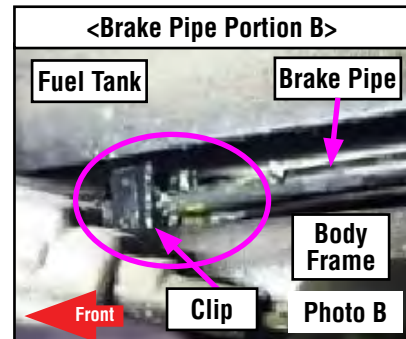

(3-3) Check for fluid leakage from Brake Pipe Portion C. (Photo C)

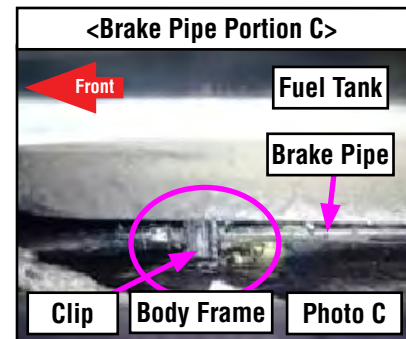

**FOR IMPREZA AND FORESTER VEHICLES**

(3-1) Check for fluid leakage from Brake Pipe Portion D. (Photo D)

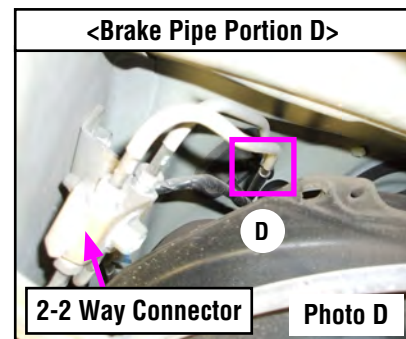

(3-2) Check for fluid leakage from Brake Pipe Portion E. (Photo E)

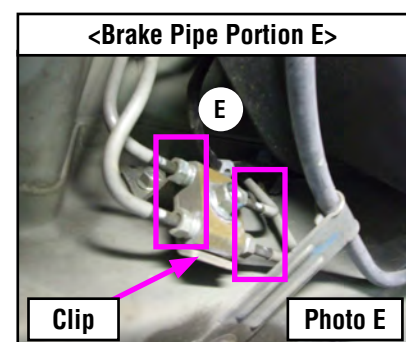

*Continued...*

(3-3) Check for fluid leakage from Brake Pipe Portion F. (Photo F)

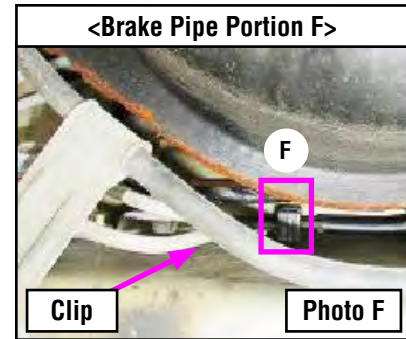

(3-4) Check for fluid leakage from Brake Pipe Portion G. (Photo G)

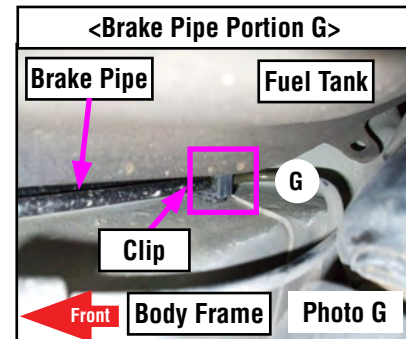

**(4) Determination of Required Repairs (for all vehicles):**

(4-1) If no brake fluid leakage is verified, Proceed to [Step 3] “APPLICATION of RUST-PROOFING”.

(4-2) If brake fluid leakage is verified, Proceed to [Step 4] “BRAKE PIPING REPLACEMENT”.

**IMPORTANT:** The decision to replace brake piping should be made ONLY when brake fluid leakage is verified. Replacement of brake piping due to other reasons including surface rust is not a matter for warranty. Questions related to any out of warranty concerns should be directed to your DPSM.

*Continued...*



## 6. [Step 3] APPLICATION OF RUST-PROOFING

### IMPORTANT:

- Always wear Safety Goggles and a Particle Mask.
- Keep away from open flame.

### (1) Preparation:

- (1-1) Assemble the spray gun and nozzle according to “4. Spray Gun: Assembly and Adjusting”.
- (1-2) Set zero-point of discharge knob and air needle of spray gun according to 4-2: Adjusting of Spray Gun: A: Zero-point Setting of Discharge Knob and Air Needle.
- (1-3) Fill in the tank with anti-rust wax.
- (1-4) Adjust wax amount and air volume by setting the discharge knob, air needle, and compressor air pressure of spray gun according to 4-2: B: Adjustment of Wax Amount and Air Volume”.
- (1-5) Test-spray wax to confirm gun operates as intended.

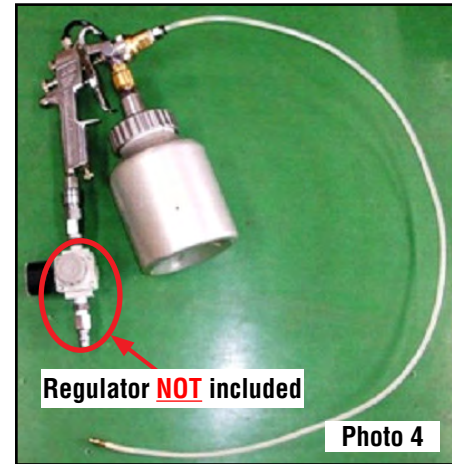

**IMPORTANT:** Application of wax should always be at room temperature as wax will not be spread effectively in cold temperatures.

### (2) Application of Anti-rust Wax:

Spray the anti-rust wax material onto each area as described using the suggested spraying time and amount listed: Spraying time: 3 seconds or more on each area.

### FOR LEGACY AND OUTBACK VEHICLES

(for Impreza and Forester vehicles, proceed to Pg.25)

- (2-1) Spraying Brake Pipe Portion A:
  - (2-1-1) Open the inspection hole cover in the fuel tank cover and insert the nozzle. (Photo A0)

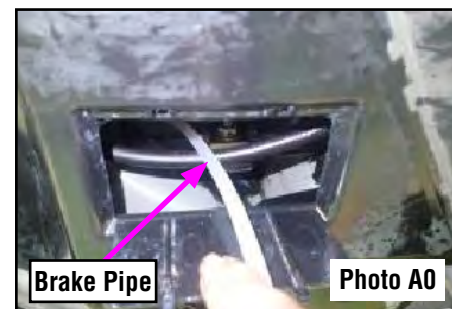

*Continued...*

(2-1-2) Insert the nozzle over the left-lower pipe of the 2-2 Way Connector. Remove the nozzle while spraying for 3 seconds or more. (Photo A1)

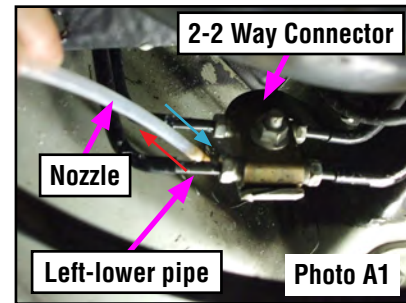

(2-1-3) Insert the nozzle over the left-upper pipe of the 2-2 Way Connector. Remove the nozzle while spraying for 3 seconds or more. (Photo A2)

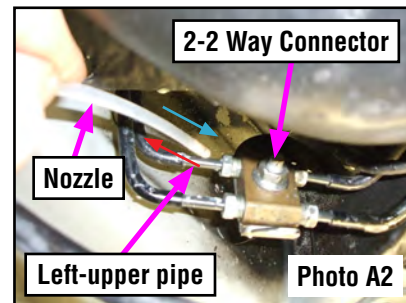

(2-1-4) Insert the nozzle over the right-upper pipe of the 2-2 Way Connector. Remove the nozzle while spraying for 3 seconds or more. (Photo A3)

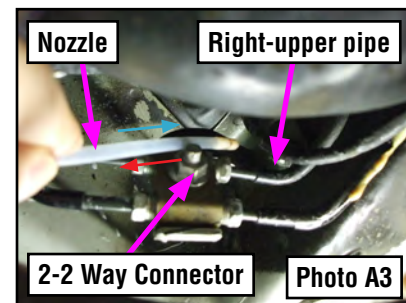

(2-1-5) Insert the nozzle over the right-lower pipe of the 2-2 Way Connector. Remove the nozzle while spraying for 3 seconds or more. (Photo A4)

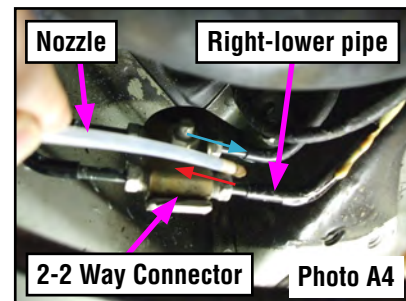

**IMPORTANT:**

- Spray until the sprayed wax material drips. (Photo A5)
- To insure the proper amount of wax is applied, follow the steps listed above closely.



*Continued...*



(2-2) Spraying Brake Pipe Portion B:

(2-2-1) Insert the nozzle between the brake pipe and the body frame in front of the clip until the nozzle touches the body frame. Remove the nozzle while spraying for 3 seconds or more. (Photo B1)

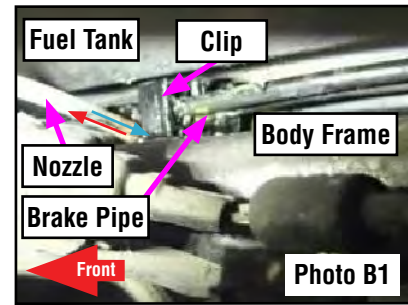

(2-2-2) Insert the nozzle between the brake pipe and the fuel tank in front of the clip until the nozzle touches the body frame. Remove the nozzle while spraying for 3 seconds or more. (Photo B2)

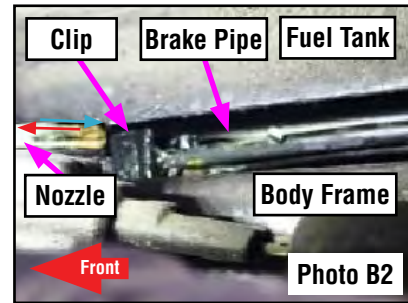

(2-2-3) Insert the nozzle between the brake pipe and the fuel tank at the rear of the clip until the nozzle touches the body frame. Remove the nozzle while spraying for 3 seconds or more. (Photo B3)

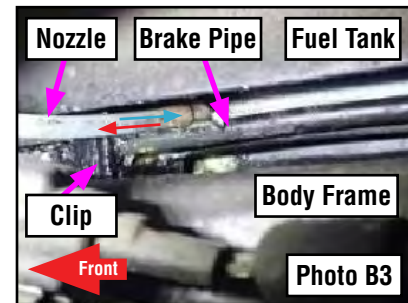

(2-2-4) Insert the nozzle between brake pipe and the body frame at the rear of the clip until the nozzle touches the body frame. Remove the nozzle while spraying for 3 seconds or more. (Photo B4)

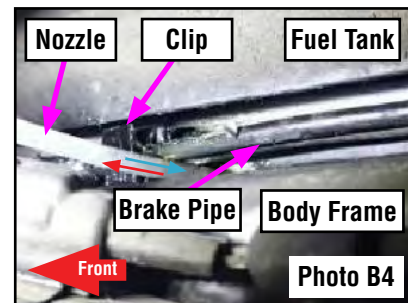

**IMPORTANT:**

- Spray until the sprayed wax material drips. (Photo B5)
- To insure the proper amount of wax is applied, follow the steps listed above closely.



*Continued...*

(2)-3) Spraying Brake Pipe C:

(2-3-1) Insert the nozzle between the brake pipe and the body frame in front of the clip as far as possible. Remove the nozzle while spraying for 3 seconds or more. (Photo C1)

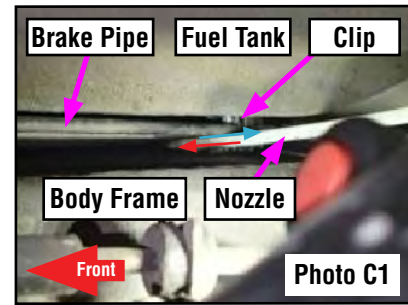

(2-3-2) Insert the nozzle between the brake pipe and the fuel tank in front of the clip as far as possible. Remove the nozzle while spraying for 3 seconds or more. (Photo C2)

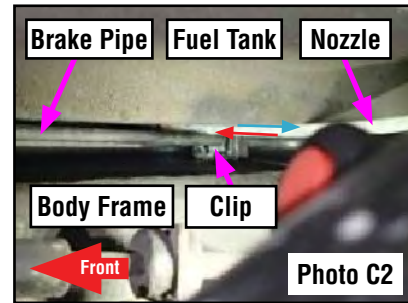

(2-3-3) Insert the nozzle between the brake pipe and the fuel tank at the rear of the clip as far as possible. Remove the nozzle while spraying for 3 seconds or more. (Photo C3)

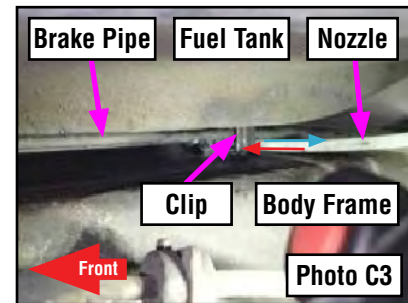

(2-3-4) Insert the nozzle between brake pipe and body frame at the rear of the clip as far as possible. Remove the nozzle while spraying for 3 seconds or more. (Photo C4)

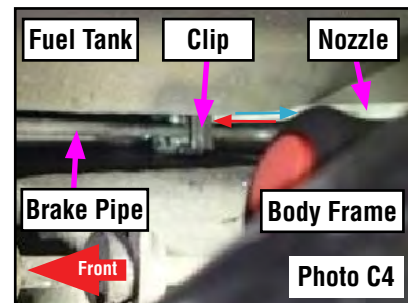

**IMPORTANT:**

- Spray until the sprayed wax material drips. (Photo C5)
- To insure the proper amount of wax is applied, follow the steps listed above closely.

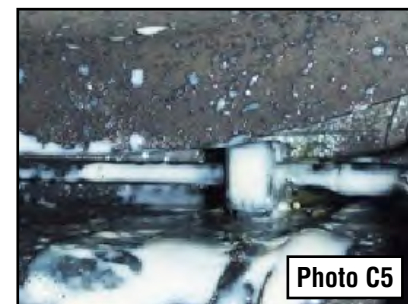

(3) Close inspection hole cover and lower the vehicle.

*Continued...*

## FOR IMPREZA AND FORESTER VEHICLES

### (2-1) Spraying Brake Pipe Portion G:

(2-1-1) Insert nozzle between the fuel tank and the body frame. (Photo G0)

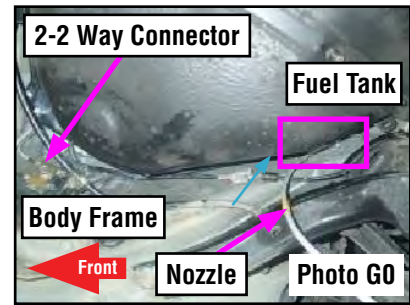

(2-1-2) Insert the nozzle in front of the clip between the brake pipe and body frame. Remove the nozzle while spraying for 3 seconds or more. (Photo G1)

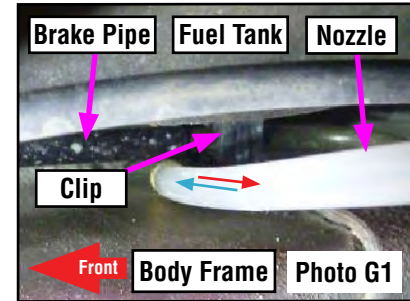

(2-1-3) Insert the nozzle in front of the clip between the brake pipe and the fuel tank. Remove the nozzle while spraying for 3 seconds or more. (Photo G2)



(2-1-4) Insert the nozzle in the rear of the clip between the brake pipe and fuel tank. Remove the nozzle while spraying for 3 seconds or more. (Photo G3)

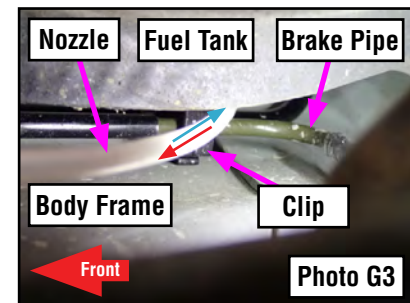

(2-1-5) Insert the nozzle in the rear of the clip between the brake pipe and body frame. Remove the nozzle while spraying for 3 seconds or more. (Photo G4)

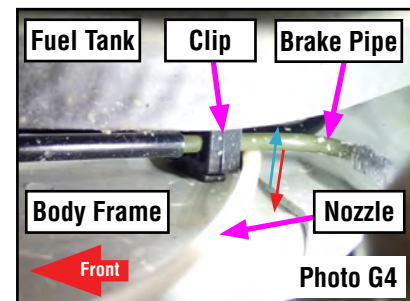

*Continued...*

(2-2) Spraying Brake Pipe Portion F:

(2-2-1) Insert the nozzle through rear of 2-2 Way Connector between the fuel tank and the body frame. Remove the nozzle while spraying for 3 seconds or more. (Photo F0)

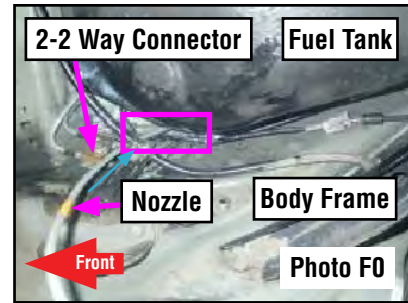

(2-2-2) Insert the nozzle in front of the clip until the nozzle touches body frame. Remove the nozzle while spraying for 3 seconds or more. (Photo F1)

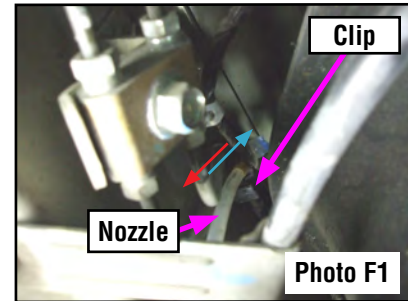

(2-2-3) Insert the nozzle in rear of the clip until nozzle touches the body frame. Remove the nozzle while spraying for 3 seconds or more. (Photo F2)

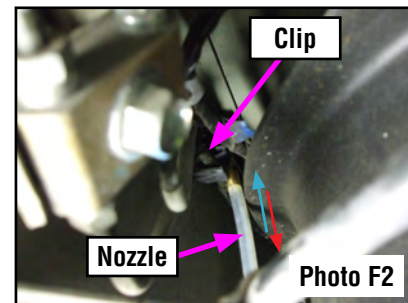

**IMPORTANT :**

- Be sure to spray until sprayed wax material drips. (Photo F3)
- To insure the proper amount of wax material is applied, follow the steps listed above closely.



(2-3) Spraying Brake Pipe Portion D:

**IMPORTANT:** Use a flashlight to illuminate the front of the fuel tank area while spraying to make sure the anti-rust wax material is applied to the proper areas.

(2-3-1) Insert the nozzle to spray the left side of the 2-2 Way Connector. Remove the nozzle while spraying for 3 seconds or more. (Photo D1)

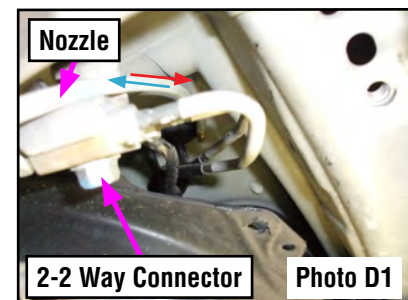

*Continued...*



(2-3-2) Insert the nozzle to spray the right side of the 2-2 Way Connector. Remove the nozzle while spraying for 3 seconds or more. (Photo D2)

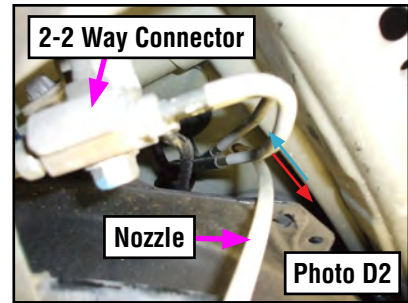

**IMPORTANT:**

- Be sure to spray until sprayed wax material drips. (Photo D3)
- To insure the proper amount of wax is applied, follow the steps listed above closely.

(3) Reinstall fuel tank cover and lower the vehicle using two (2) new **Self-Lock** nuts.

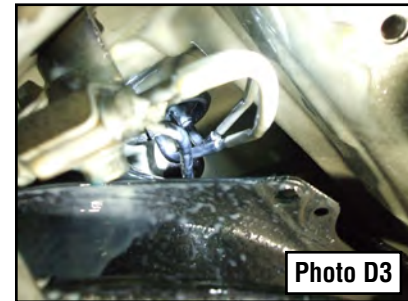

**REMINDER:** The 2 self-locking nuts securing each fuel tank cover are **one-time use** items and must always be replaced when removed.

**7. [Step 4] BRAKE PIPING REPLACEMENT (ONLY after confirming fluid leakage)**

Replace applicable PIPE ASSY CTR BK, PIPE ASSY R and CONNECTOR 2-2WAY with new parts using the applicable part numbers listed in the Parts catalog and following the procedure outlined in the applicable Service Manual.

**IMPORTANT:** After installation of any replacement brake piping is complete, the anti-rust wax material must be applied to complete the repair. Follow the procedures listed above for application of anti-rust wax material to the new brake piping: **[Step 3] APPLICATION of RUST-PROOFING.**

**RECALL IDENTIFICATION LABEL**

Type or print the necessary information on a Service Program identification label. The completed label should be attached to the vehicle's upper radiator support.

Additional labels are available through normal parts ordering channels. The part number is MSA6P1302. Ordering qty 1 = 1 sheet of 20 labels.

PART NUMBER	APPLICABILITY	DESCRIPTION	ORDER QUANTITY
MSA6P1302	All models	Campaign Completion Labels (contains one sheet of 20 labels)	1

<b>SUBARU</b>
Campaign Code
<b>WQK-47</b>
COMPLETED
DIST./DEALER NO.
SERIAL NO.
<b>DO NOT REMOVE</b>

*Continued...*

## CLAIM REIMBURSEMENT AND ENTRY PROCEDURES

Credit to perform this recall will be based on the submission of properly completed repair order information. Retailers may submit claims through 'Vehicle Claim Entry' on Subarunet.com.

Listed below is claim entry information:

CLAIM TYPE	CAMPAIGN CODE	APPLICABILITY	LABOR	DESCRIPTION	LABOR TIME
RC	WQK-47	Impreza, WRX, STI, and Forester	A153-548	Brake Pipe Inspection and Rustproofing	0.3
			A153-544	Brake Pipe Inspection, Replacement and Rustproofing	6.0
		Legacy and Outback	A153-348	Brake Pipe Inspection and Rustproofing	0.2
			A153-344	Brake Pipe Inspection, Replacement and Rustproofing	6.8

PART NUMBER	APPLICABILITY	DESCRIPTION	QUANTITY
SOA635133	All models	Nox-Rust® 712AM Rust-proofing material – one repair (for claim purposes only)	1
42009FG000	Impreza, WRX, STI, and Forester	WQK-47 Self Lock Nut Kit (contains two self locking nuts)	1

If brake line replacement is necessary, please refer to the parts catalog for the applicable part numbers.

*Continued...*

# OWNER NOTIFICATION LETTER (FORESTER, IMPREZA, WRX AND STI)

**IMPORTANT SAFETY RECALL**  
**This notice applies to the VIN identified  
in the address section printed below.**



**Subaru of America, Inc**  
Subaru Plaza  
PO Box 6000  
Cherry Hill, NJ 08034-6000  
800-782-2783  
www.subaru.com

**Subaru Recall Campaign WQK-47**  
**NHTSA Recall No. 14V-311**  
**July 2014**

## Dear Subaru Owner:

This notice is sent to you in accordance with the National Traffic and Motor Vehicle Safety Act.

SUBARU OF AMERICA, INC. has decided that a defect, which relates to motor vehicle safety, exists in some 2009-2013 Subaru Forester models, some 2008-2011 model year Subaru Impreza, WRX, and STI vehicles, and in some 2012-2014 model year Subaru Impreza WRX and STI vehicles currently or formerly registered in at least one of the following states and the District of Columbia:

Connecticut	Maine	New Hampshire	Vermont
Delaware	Maryland	New Jersey	West Virginia
District of Columbia	Massachusetts	New York	Wisconsin
Illinois	Michigan	Ohio	
Indiana	Minnesota	Pennsylvania	
Iowa	Missouri	Rhode Island	

## DESCRIPTION OF THE SAFETY DEFECT

Subaru has determined that your vehicle may have been manufactured with brake lines that could, over time, corrode if exposed to salt, such as salt used to treat roads in the winter time.

Depending on driving conditions, salt water could splash on the brake lines through a gap in the fuel tank protector, resulting in excessive corrosion of the lines. Excessive corrosion could eventually cause perforation of a brake line(s) resulting in a brake fluid leak.

## DESCRIPTION OF THE SAFETY HAZARD

Your vehicle has a dual circuit braking system. Each circuit works independently and diagonally across the vehicle. If one circuit of the brake system fails, the other half of the system still works. Should a brake line corrode to the point of developing a perforation, brake fluid will leak from the line(s) causing the related circuit to eventually lose effectiveness. In this situation, there would be an increase in the amount of brake pedal travel distance and foot pressure required to slow or stop the vehicle. This might cause the driver to misjudge the amount of brake pedal travel required to achieve the desired stopping distance, increasing the risk of a crash.

## INSPECTION / REPAIR

Subaru will inspect and test the current condition of your vehicle's brake lines. If they are found to be acceptable, anti-corrosion material will be applied to the areas of concern as a preventative measure. If any of the lines are found to be unacceptable, they will be replaced and anti-corrosion material will be applied to the new brake lines. These repairs will be performed at no cost to you.

*Continued...*



## WHAT YOU SHOULD DO

Subaru is in the process of acquiring anti-corrosion materials and replacement parts necessary to perform this repair. Once there is a sufficient supply of the anti-corrosion materials and parts to perform this repair, Subaru will re-contact you by mail advising you to proceed with scheduling an appointment with your Subaru retailer (dealer).

There are several important precautions you should take until this repair has been performed:

- If you experience the condition described above while braking, continue to apply steady pressure on the brake pedal until the vehicle comes to a stop. Immediately contact your Subaru retailer for assistance.
- If you notice fluid leaking from the vehicle, do not operate the vehicle. Immediately contact your Subaru retailer for assistance.
- If the brake system warning light remains illuminated on the instrument panel with the parking brake fully released, do not operate the vehicle. Immediately contact your Subaru retailer for assistance.
- Always maintain a safe distance from other vehicles while driving. The normally recommended minimum distance is one car length of space for every 10 mph of speed.
- As a precautionary measure, it is highly recommended that you use extra care while operating the vehicle in confined areas such as parking lots and while parking your vehicle in a garage, car port or other structure.

## IF YOU HAVE PREVIOUSLY PAID FOR A REPAIR

If you have already paid for repairs associated with this condition, you may be eligible for reimbursement. Reimbursement consideration will be based on the amount an authorized Subaru retailer in your area would charge for the same repair.

Please send the original service repair order, which has the name of the repair facility, date of repair, mileage at the time of repair, complete 17-digit vehicle identification number (VIN), and your name, with correct mailing address and telephone number to the address listed below.

**Subaru of America, Inc.**  
**Customer-Retailer Services Department, Attention: WQK-47 Recall**  
**P.O. Box 6000, Cherry Hill, NJ 08034-6000**

Please send original receipts only and retain a photocopy for your records. Please be assured that we will attempt to process your reimbursement request as quickly as possible, but it may take up to 60 days for this process to be completed.

## CHANGED YOUR ADDRESS OR SOLD YOUR SUBARU?

If you have moved or sold your vehicle, please complete the enclosed prepaid postcard and mail it to us. Or, if you prefer to update this information online, please go to [www.subaru.com](http://www.subaru.com), select Contact Us then select Update Address from the drop down menu.

## IF YOU NEED FURTHER ASSISTANCE:

To locate the nearest Subaru Dealer you can access our website at [www.subaru.com](http://www.subaru.com) and select "Find a Dealer".

If you need additional assistance, please contact us directly:

- E-mail: Go to [www.subaru.com](http://www.subaru.com) and select "Contact Us".
- Telephone: 1-800-SUBARU3 (1-800-782-2783)  
Monday through Thursday between 7:30 a.m. and 8:00 p.m. ET.  
Friday between 10:30 a.m. and 5:00 p.m. ET  
Saturday between 9:00 a.m. and 3:30 p.m. ET
- U.S. Postal mail: Write us at Subaru of America, Inc.  
Attn: CDS Department, P.O. Box 6000, Cherry Hill, NJ 08034-6000.

*Continued...*

After you receive a second notice from Subaru informing you that there is a sufficient supply of the anti-corrosion materials and parts to perform this repair, please contact us immediately if the Subaru retailer fails or is unable to make the necessary repairs free of charge.

You may also contact the Administrator, National Highway Traffic Safety Administration, 1200 New Jersey Ave. SE, West Building, Washington, DC 20590 or call the toll free Auto Safety Hotline at 1-888-327-4236 (TTY: 1-800-424-9153) or go to <http://www.safercar.gov> if you believe the Subaru retailer has failed or is unable to remedy your vehicle without charge within a reasonable amount of time.

Your continued satisfaction with your Subaru is important to us. Please understand that we have taken this action in the interest of your safety and your vehicle's proper operation. We sincerely apologize for any inconvenience this matter may cause and upon second notification we urge you to schedule an appointment as soon as possible to have this repair performed.

Sincerely,  
Subaru of America, Inc.

**Notice to Lessors:** *Under Federal law the lessor of a vehicle who receives this letter must provide a copy of it to the vehicle lessee(s) within 10 business days from receipt. The lessor must also keep a record of the lessee(s) to whom this letter is sent, the date sent, and the applicable vehicle identification number (VIN). (For the purposes of this section, a lessor means a person or entity that in the last twelve months prior to the date of this notification has been the owner, as referenced on the vehicle's title, of any five or more leased vehicles. A leased vehicle is a vehicle leased to another person for a term of at least four months.)*

***A subsidiary of Fuji Heavy Industries Ltd.***

# OWNER NOTIFICATION LETTER (LEGACY AND OUTBACK)

## **IMPORTANT SAFETY RECALL**

**This notice applies to the VIN identified in the address section printed below.**



**Subaru of America, Inc**

Subaru Plaza  
PO Box 6000  
Cherry Hill, NJ 08034-6000  
800-782-2783  
www.subaru.com

**Subaru Recall Campaign WQK-47  
NHTSA Recall No. 14V-311  
July 2014**

### **Dear Subaru Owner:**

This notice is sent to you in accordance with the National Traffic and Motor Vehicle Safety Act.

SUBARU OF AMERICA, INC. has decided that a defect, which relates to motor vehicle safety, exists in some 2005-2009 Subaru Legacy and Outback models currently or formerly registered in at least one of the following states and the District of Columbia:

Connecticut	Maine	New Hampshire	Vermont
Delaware	Maryland	New Jersey	West Virginia
District of Columbia	Massachusetts	New York	Wisconsin
Illinois	Michigan	Ohio	
Indiana	Minnesota	Pennsylvania	
Iowa	Missouri	Rhode Island	

### **DESCRIPTION OF THE SAFETY DEFECT**

Subaru has determined that your vehicle may have been manufactured with brake lines that could, over time, corrode if exposed to salt, such as salt used to treat roads in the winter time.

Depending on driving conditions, salt water could splash on the brake lines through a gap in the fuel tank protector, resulting in excessive corrosion of the lines. Excessive corrosion could eventually cause perforation of a brake line(s) resulting in a brake fluid leak.

### **DESCRIPTION OF THE SAFETY HAZARD**

Your vehicle has a dual circuit braking system. Each circuit works independently and diagonally across the vehicle. If one circuit of the brake system fails, the other half of the system still works. Should a brake line corrode to the point of developing a perforation, brake fluid will leak from the line(s) causing the related circuit to eventually lose effectiveness. In this situation, there would be an increase in the amount of brake pedal travel distance and foot pressure required to slow or stop the vehicle. This might cause the driver to misjudge the amount of brake pedal travel required to achieve the desired stopping distance, increasing the risk of a crash.

### **INSPECTION / REPAIR**

Subaru will inspect and test the current condition of your vehicle's brake lines. If they are found to be acceptable, anti-corrosion material will be applied to the areas of concern as a preventative measure. If any of the lines are found to be unacceptable, they will be replaced and anti-corrosion material will be applied to the new brake lines. These repairs will be performed at no cost to you.

### **THIS RECALL REPLACES AND UPDATES ANY PREVIOUS BRAKE LINE CORROSION RECALL-RELATED REPAIRS PERFORMED**

This recall replaces and updates Subaru's previous brake line corrosion recall applicable to some 2005-2009 Legacy and Outback models, issued in May of 2013. In addition to the repair procedure of the previous recall, this recall includes inspection and treatment of other areas of the brake lines.

*Continued...*

**IMPORTANT NOTE:** *If you already had a previous brake line corrosion recall repair performed on your vehicle, you must also have this recall performed to ensure that all affected areas are acceptable and treated with anti-corrosion material as a preventative measure.*

## **WHAT YOU SHOULD DO**

You should immediately contact your Subaru retailer (dealer) for an appointment to have the brake lines inspected and repaired as indicated in the “Inspection / Repair” section of this letter.

There are several important precautions you should take until this repair has been performed:

- If you experience the condition described above while braking, continue to apply steady pressure on the brake pedal until the vehicle comes to a stop. Immediately contact your Subaru retailer for assistance.
- If you notice fluid leaking from the vehicle, do not operate the vehicle. Immediately contact your Subaru retailer for assistance.
- If the brake system warning light remains illuminated on the instrument panel with the parking brake fully released, do not operate the vehicle. Immediately contact your Subaru retailer for assistance.
- Always maintain a safe distance from other vehicles while driving. The normally recommended minimum distance is one car length of space for every 10 mph of speed.
- As a precautionary measure, it is highly recommended that you use extra care while operating the vehicle in confined areas such as parking lots and while parking your vehicle in a garage, car port or other structure.

## **HOW LONG WILL THE REPAIR TAKE?**

The time to inspect the brake lines and apply anti-corrosion material is approximately 12 minutes. If it is determined that the brake lines require replacement, the total estimated repair time is 7 hours. However, it may be necessary to leave your vehicle for a longer period of time on the day of your scheduled appointment to allow your Subaru retailer flexibility in scheduling. Please present this letter to your Subaru retailer at the time this repair procedure is performed.

## **IF YOU HAVE PREVIOUSLY PAID FOR A REPAIR**

If you have already paid for repairs associated with this condition, you may be eligible for reimbursement. Reimbursement consideration will be based on the amount an authorized Subaru retailer in your area would charge for the same repair.

Please send the original service repair order, which has the name of the repair facility, date of repair, mileage at the time of repair, complete 17-digit vehicle identification number (VIN), and your name, with correct mailing address and telephone number to the address listed below.

**Subaru of America, Inc.**  
**Customer-Retailer Services Department, Attention: WQK-47 Recall**  
**P.O. Box 6000, Cherry Hill, NJ 08034-6000**

Please send original receipts only and retain a photocopy for your records. Please be assured that we will attempt to process your reimbursement request as quickly as possible, but it may take up to 60 days for this process to be completed.

## **CHANGED YOUR ADDRESS OR SOLD YOUR SUBARU?**

If you have moved or sold your vehicle, please complete the enclosed prepaid postcard and mail it to us. Or, if you prefer to update this information online, please go to [www.subaru.com](http://www.subaru.com), select Contact Us then select Update Address from the drop down menu.

## **IF YOU NEED FURTHER ASSISTANCE:**

To locate the nearest Subaru Dealer you can access our website at [www.subaru.com](http://www.subaru.com) and select “Find a Dealer”.

*Continued...*

If you need additional assistance, please contact us directly:

- E-mail: Go to [www.subaru.com](http://www.subaru.com) and select "Contact Us".
- Telephone: 1-800-SUBARU3 (1-800-782-2783)  
Monday through Thursday between 7:30 a.m. and 8:00 p.m. ET.  
Friday between 10:30 a.m. and 5:00 p.m. ET  
Saturday between 9:00 a.m. and 3:30 p.m. ET
- U.S. Postal mail: Write us at Subaru of America, Inc.  
Attn: CDS Department, P.O. Box 6000, Cherry Hill, NJ 08034-6000.

Please contact us immediately if the Subaru retailer fails or is unable to make the necessary repairs free of charge.

You may also contact the Administrator, National Highway Traffic Safety Administration, 1200 New Jersey Ave. SE, West Building, Washington, DC 20590 or call the toll free Auto Safety Hotline at 1-888-327-4236 (TTY: 1-800-424-9153) or go to <http://www.safercar.gov> if you believe the Subaru retailer has failed or is unable to remedy your vehicle without charge within a reasonable

Your continued satisfaction with your Subaru is important to us. Please understand that we have taken this action in the interest of your safety and your vehicle's proper operation. We sincerely apologize for any inconvenience this matter may cause and urge you to schedule an appointment as soon as possible to have this repair performed.

Sincerely,  
Subaru of America, Inc.

***Notice to Lessors:*** Under Federal law the lessor of a vehicle who receives this letter must provide a copy of it to the vehicle lessee(s) within 10 business days from receipt. The lessor must also keep a record of the lessee(s) to whom this letter is sent, the date sent, and the applicable vehicle identification number (VIN). (For the purposes of this section, a lessor means a person or entity that in the last twelve months prior to the date of this notification has been the owner, as referenced on the vehicle's title, of any five or more leased vehicles. A leased vehicle is a vehicle leased to another person for a term of at least four months.)

***A subsidiary of Fuji Heavy Industries Ltd.***

# SAFETY DATA SHEET

## 1. Identification

**Product identifier** NOX-RUST 712AM

### Other means of identification

**SDS number** 140017

**Recommended use** Rust preventing oil.

**Recommended restrictions** None known.

### Manufacturer / Importer / Supplier / Distributor information

**Supplier** Parker Industries, Inc.

**Address** 15-1, Nihonbashi 1-chome, Chuo-ku, Tokyo 103-0027 JAPAN

**Telephone** +81 (3) 5205-1971

**Contact person** Noriharu Tanaka

**e-mail** ntanaka@parkerind.co.jp

**Emergency phone number** +81-47-431-3598

## 2. Hazard(s) identification

**Physical hazards** Not classified.

**Health hazards** Not classified.

**Environmental hazards** Not classified.

**OSHA defined hazards** Not classified.

### Label elements

**Hazard symbol** None.

**Signal word** Not available.

**Hazard statement** Not available.

### Precautionary statement

**Prevention** Observe good industrial hygiene practices.

**Response** Wash skin with soap and water.

**Storage** Store in a closed container.

**Disposal** Dispose of waste and residues in accordance with local authority requirements.

**Hazard(s) not otherwise classified (HNOC)** None known.

## 3. Composition/information on ingredients

### Mixtures

Chemical name	CAS number	%
Mineral oil	Proprietary	<60
Rust preventive additive	Proprietary	<10

**Composition comments** All concentrations are in percent by weight unless ingredient is a gas. Gas concentrations are in percent by volume.

## 4. First-aid measures

**Inhalation** Move to fresh air. Get medical attention if any discomfort continues.

**Skin contact** Rinse with water. Get medical attention if irritation persists after washing.

**Eye contact** Rinse the eye with water immediately. Get medical attention if irritation develops and persists.

**Ingestion** Rinse mouth thoroughly. Get medical attention if any discomfort continues.

**Most important symptoms/effects, acute and delayed** Prolonged contact may cause dryness of the skin.

**Indication of immediate medical attention and special treatment needed** Treat symptomatically.

**General information** First aid personnel must be aware of own risk during rescue.

## 5. Fire-fighting measures

<b>Suitable extinguishing media</b>	Use fire-extinguishing media appropriate for surrounding materials.
<b>Unsuitable extinguishing media</b>	None known.
<b>Specific hazards arising from the chemical</b>	By heating and fire, toxic vapors/gases may be formed.
<b>Special protective equipment and precautions for firefighters</b>	Selection of respiratory protection for firefighting: follow the general fire precautions indicated in the workplace. Self-contained breathing apparatus and full protective clothing must be worn in case of fire.
<b>Fire-fighting equipment/instructions</b>	Use standard firefighting procedures and consider the hazards of other involved materials. Prevent runoff from fire control or dilution from entering streams, sewers, or drinking water supply.
<b>General fire hazards</b>	Will burn if involved in a fire.

## 6. Accidental release measures

<b>Personal precautions, protective equipment and emergency procedures</b>	Wear suitable protective clothing, gloves and eye/face protection. Avoid prolonged and repeated contact.
<b>Methods and materials for containment and cleaning up</b>	Absorb spillage with suitable absorbent material.
<b>Environmental precautions</b>	Avoid discharge into drains, water courses or onto the ground.

## 7. Handling and storage

<b>Precautions for safe handling</b>	Avoid prolonged and repeated contact. Observe good industrial hygiene practices.
<b>Conditions for safe storage, including any incompatibilities</b>	Store in a well-ventilated place. Keep container tightly closed. Store away from incompatible materials.

## 8. Exposure controls/personal protection

### Occupational exposure limits

#### US. OSHA Table Z-1 Limits for Air Contaminants (29 CFR 1910.1000)

Components	Type	Value	Form
Mineral oil (CAS Proprietary)	PEL	5 mg/m3	Mist.
Rust preventive additive (CAS Proprietary)	PEL	5 mg/m3	Respirable fraction.
		15 mg/m3	Total dust.

#### US. ACGIH Threshold Limit Values

Components	Type	Value	Form
Mineral oil (CAS Proprietary)	TWA	5 mg/m3	Inhalable fraction.

#### US. NIOSH: Pocket Guide to Chemical Hazards

Components	Type	Value	Form
Mineral oil (CAS Proprietary)	STEL	10 mg/m3	Mist.
	TWA	5 mg/m3	Mist.
Rust preventive additive (CAS Proprietary)	TWA	5 mg/m3	Respirable.
		10 mg/m3	Total

<b>Biological limit values</b>	No biological exposure limits noted for the ingredient(s).
<b>Appropriate engineering controls</b>	Provide adequate ventilation. Observe occupational exposure limits and minimize the risk of inhalation of vapors and mist.
<b>Individual protection measures, such as personal protective equipment</b>	
<b>Eye/face protection</b>	Risk of splashes: Wear approved safety goggles.
<b>Skin protection</b>	
<b>Hand protection</b>	For prolonged or repeated skin contact use suitable protective gloves.
<b>Other</b>	Wear appropriate clothing to prevent repeated or prolonged skin contact.
<b>Respiratory protection</b>	In case of inadequate ventilation or risk of inhalation of oil mist, suitable respiratory equipment with particulate filter and organic vapor cartridges can be used.
<b>Thermal hazards</b>	Wear appropriate thermal protective clothing, when necessary.

*Continued...*



**General hygiene considerations** Always observe good personal hygiene measures, such as washing after handling the material and before eating, drinking, and/or smoking. Routinely wash work clothing and protective equipment to remove contaminants.

## 9. Physical and chemical properties

**Appearance** Viscous liquid.  
**Physical state** Liquid.  
**Form** Viscous liquid.  
**Color** Yellowish brown.  
**Odor** Fatty. Oily.  
**Odor threshold** Not available.  
**pH** Not available.  
**Melting point/freezing point** Not available.  
**Initial boiling point and boiling range** > 482 °F (> 250 °C)  
**Flash point** > 410.0 °F (> 210.0 °C)  
**Evaporation rate** Not available.  
**Flammability (solid, gas)** Not applicable.  
**Upper/lower flammability or explosive limits**  
**Flammability limit - lower (%)** Not available.  
**Flammability limit - upper (%)** Not available.  
**Vapor pressure** Not available.  
**Vapor density** Not available.  
**Relative density** 0.9 - 1  
**Solubility(ies)**  
**Solubility (water)** Not available.  
**Partition coefficient (n-octanol/water)** Not available.  
**Auto-ignition temperature** Not available.  
**Decomposition temperature** Not available.  
**Viscosity** 1000 mPa·s (20 °C)

## 10. Stability and reactivity

**Reactivity** The product is non-reactive under normal conditions of use, storage and transport.  
**Chemical stability** Stable under normal temperature conditions.  
**Possibility of hazardous reactions** Will not occur.  
**Conditions to avoid** Contact with incompatible materials.  
**Incompatible materials** Strong oxidizing agents.  
**Hazardous decomposition products** Carbon oxides. Sulfur dioxide. Nitrogen oxides. Calcium oxides.

## 11. Toxicological information

### Information on likely routes of exposure

**Ingestion** May cause discomfort if swallowed.  
**Inhalation** Under normal conditions of intended use, this material is not expected to be an inhalation hazard.  
**Skin contact** Prolonged contact may cause dryness of the skin.  
**Eye contact** May cause temporary eye irritation. May cause redness and pain.

**Symptoms related to the physical, chemical and toxicological characteristics** Prolonged contact may cause dryness of the skin.

### Information on toxicological effects

**Acute toxicity** May cause discomfort if swallowed.

Components	Species	Test Results
Rust preventive additive (CAS Proprietary)		
<b>Acute</b>		
<b>Oral</b>		
LD50	Mouse	6450 mg/kg
	Rat	6450 mg/kg
<b>Skin corrosion/irritation</b>	Prolonged contact may cause dryness of the skin.	
<b>Serious eye damage/eye irritation</b>	May cause temporary eye irritation. May cause redness and pain.	
<b>Respiratory or skin sensitization</b>		
<b>Respiratory sensitization</b>	No data available.	
<b>Skin sensitization</b>	No data available.	
<b>Germ cell mutagenicity</b>	No data available.	
<b>Carcinogenicity</b>	No data available.	
<b>Reproductive toxicity</b>	No data available.	
<b>Specific target organ toxicity - single exposure</b>	No data available.	
<b>Specific target organ toxicity - repeated exposure</b>	No data available.	
<b>Aspiration hazard</b>	No data available.	
<b>Chronic effects</b>	No data available.	
<b>12. Ecological information</b>		
<b>Ecotoxicity</b>	The product components are not classified as environmentally hazardous. However, this does not exclude the possibility that large or frequent spills can have a harmful or damaging effect on the environment.	
<b>Persistence and degradability</b>	No data available.	
<b>Bioaccumulative potential</b>	No data available.	
<b>Mobility in soil</b>	No data available.	
<b>Mobility in general</b>	No data available.	
<b>Other adverse effects</b>	No data available.	
<b>13. Disposal considerations</b>		
<b>Disposal instructions</b>	Dispose of in accordance with local regulations.	
<b>Hazardous waste code</b>	The waste code should be assigned in discussion between the user, the producer and the waste disposal company.	
<b>Waste from residues / unused products</b>	Dispose in accordance with all applicable regulations. Do not discharge into drains, water courses or onto the ground.	
<b>Contaminated packaging</b>	Since emptied containers may retain product residue, follow label warnings even after container is emptied.	
<b>14. Transport information</b>		
<b>DOT</b>		
	Not regulated as dangerous goods.	
<b>IATA</b>		
	Not regulated as dangerous goods.	
<b>IMDG</b>		
	Not regulated as dangerous goods.	
<b>Transport in bulk according to Annex II of MARPOL 73/78 and the IBC Code</b>	Not applicable.	
<b>15. Regulatory information</b>		
<b>US federal regulations</b>	This product is not known to be a "Hazardous Chemical" as defined by the OSHA Hazard Communication Standard, 29 CFR 1910.1200.	
<b>TSCA Section 12(b) Export Notification (40 CFR 707, Subpt. D)</b>		
	Not regulated.	
<b>US. OSHA Specifically Regulated Substances (29 CFR 1910.1001-1050)</b>		
	Not listed.	

**CERCLA Hazardous Substance List (40 CFR 302.4)**

Not listed.

**Superfund Amendments and Reauthorization Act of 1986 (SARA)**

**Hazard categories** Immediate Hazard - No  
Delayed Hazard - No  
Fire Hazard - No  
Pressure Hazard - No  
Reactivity Hazard - No

**SARA 302 Extremely hazardous substance**

Not listed.

**SARA 311/312 Hazardous chemical** No

**SARA 313 (TRI reporting)**  
Not regulated.

**Other federal regulations**

**Clean Air Act (CAA) Section 112 Hazardous Air Pollutants (HAPs) List**

Not regulated.

**Clean Air Act (CAA) Section 112(r) Accidental Release Prevention (40 CFR 68.130)**

Not regulated.

**Safe Drinking Water Act (SDWA)** Not regulated.

**US state regulations**

**US. Massachusetts RTK - Substance List**

Mineral oil (CAS Proprietary)  
Rust preventive additive (CAS Proprietary)

**US. New Jersey Worker and Community Right-to-Know Act**

Mineral oil (CAS Proprietary)  
Rust preventive additive (CAS Proprietary)

**US. Pennsylvania Worker and Community Right-to-Know Law**

Rust preventive additive (CAS Proprietary)

**US. Rhode Island RTK**

Not regulated.

**US. California Proposition 65**

California Safe Drinking Water and Toxic Enforcement Act of 1986 (Proposition 65): This material is not known to contain any chemicals currently listed as carcinogens or reproductive toxins.

**US - California Proposition 65 - Carcinogens & Reproductive Toxicity (CRT): Listed substance**

Not listed.

**International Inventories**

Country(s) or region	Inventory name	On inventory (yes/no)*
Australia	Australian Inventory of Chemical Substances (AICS)	Yes
Canada	Domestic Substances List (DSL)	Yes
Canada	Non-Domestic Substances List (NDSL)	No
China	Inventory of Existing Chemical Substances in China (IECSC)	Yes
Korea	Existing Chemicals List (ECL)	Yes
New Zealand	New Zealand Inventory	Yes
United States & Puerto Rico	Toxic Substances Control Act (TSCA) Inventory	Yes

\*A "Yes" indicates this product complies with the inventory requirements administered by the governing country(s).

A "No" indicates that one or more components of the product are not listed or exempt from listing on the inventory administered by the governing country(s).

**16. Other information, including date of preparation or last revision**

**Issue date** 06-March-2014  
**Revision date** -  
**Version #** 01

*Continued...*

**NFPA Ratings**

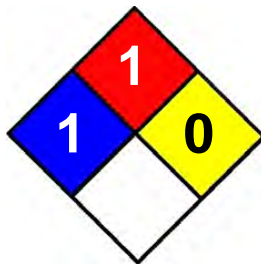

**Disclaimer**

This information is provided without warranty. The information is believed to be correct. This information should be used to make an independent determination of the methods to safeguard workers and the environment.