



Recall Bulletin



PRODUCT SAFETY RECALL

SUBJECT: Brake Lamp Malfunction

MODELS: 2004-2012 Chevrolet Malibu
2004-2007 Chevrolet Malibu Maxx
2005-2010 Pontiac G6
2007-2010 Saturn Aura

In response to recent dealer inquiries, the Part Information and Service Procedure sections have been revised. Discard all copies of bulletin 13036.

It is a violation of Federal law for a dealer to deliver a new motor vehicle or any new or used item of motor vehicle equipment (including a tire) covered by this notification under a sale or lease until the defect or noncompliance is remedied.

All involved vehicles that are in dealer inventory must be held and not delivered to customers, dealer traded, or used for demonstration purposes until the repair contained in this bulletin has been performed on the vehicle.

CONDITION

General Motors has decided that a defect which relates to motor vehicle safety exists in 2004-2012 model year (MY) Chevrolet Malibu, 2004-2007 MY Chevrolet Malibu Maxx, 2005-2010 MY Pontiac G6, 2007-2010 MY Saturn Aura vehicles. On these vehicles, over time an increased resistance can develop in the Body Control Module (BCM) connection system and result in voltage fluctuations or intermittency in the Brake Apply Sensor (BAS) circuit that can cause service brake lamp malfunction. As a result, the service brake lamps may illuminate when the service brakes are not being applied, or may not illuminate when the service brakes are being applied. Additionally, cruise control may not engage. If cruise control is engaged, additional service brake pedal travel may be required to disengage it. Service brake pedal application may not be required to move the shift lever out of PARK, or additional service brake pedal travel may be required to move the shift lever out of PARK. Traction control, electronic stability control, and panic braking assist features, if equipped, may be disabled. Service ESC and/or Traction Control tell-tales may illuminate with this condition. These conditions may increase the risk of a crash.

CORRECTION

Dealers are to attach the wiring harness to the BCM with a spacer, apply dielectric lubricant to both the BCM and harness connector and on the BAS and harness connector, and relearn the brake pedal home position.

VEHICLES INVOLVED

All involved vehicles are identified by Vehicle Identification Number on the Investigate Vehicle History screen in GM Global Warranty Management system. Dealership service personnel should always check this site to confirm vehicle involvement prior to beginning any required inspections and/or repairs. It is important to routinely use this tool to verify eligibility because not all similar vehicles may be involved regardless of description or option content.

For dealers with involved vehicles, a listing with involved vehicles containing the complete vehicle identification number, customer name, and address information has been prepared and will be provided to U.S. and Canadian dealers through the GM GlobalConnect Recall Reports, or sent directly to export dealers. Dealers will not have a report available if they have no involved vehicles currently assigned.

The listing may contain customer names and addresses obtained from Motor Vehicle Registration Records. The use of such motor vehicle registration data for any purpose other than follow-up necessary to complete this recall is a violation of law in several states/provinces/countries. Accordingly, you are urged to limit the use of this report to the follow-up necessary to complete this recall.

PART INFORMATION

Parts required to complete this recall are to be obtained from General Motors Customer Care and Aftersales (GMCCA). Please refer to your "involved vehicles listing" before ordering parts. Normal orders should be placed on a DRO = Daily Replenishment Order. In an emergency situation, parts should be ordered on a CSO = Customer Special Order.

Part Number	Description	Quantity/Vehicle
15188763	RETAINER-BRK PED (Short Tie Strap - Pkg of 10)	1
11509086	STRAP-EGR TUBE (Long Tie Strap - Pkg of 10)	2
13596990	CLIP-WRG HARN (Tie-Down Mount)	1
13596991	RETAINER-ACSR Y WRG HARN (Rubber Spacer)	1 (If Required)
12378462 – US 10953554 - CA	PROMOTER, PLASTIC ADHESION (4 OZ)	As Required (Submit as Net Item)
12377900 – US 10953529 - CA	LUBRICANT, DIELECTRIC (2OZ)	As Required (Submit as Net Item)
KENT AUTOMOTIVE 1089482	WOVEN POLYESTER ELECTRICAL TAPE (PET) (Do not order from GMCCA - Obtain Locally)	As Required (Submit as Net Item)

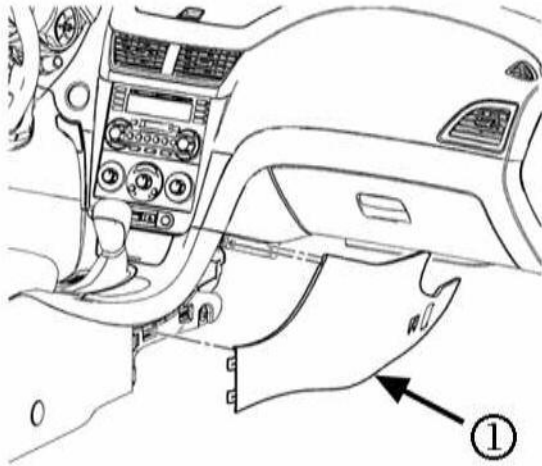
SERVICE PROCEDURE

3963121

1. Remove the right side front floor console side trim panel (1) to access the Body Control Module (BCM).



3684285

2. Unlatch the C2 or X2 connector (1) and disconnect the connector from the BCM.
3. Remove the blue latch cover from the connector.

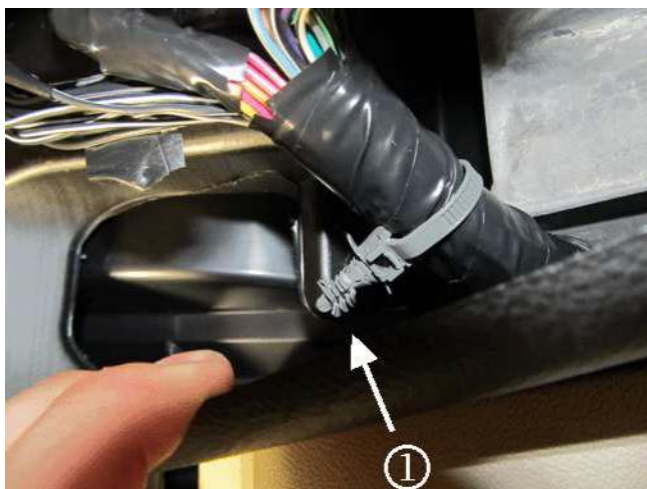

3963124

Note: When working on the following steps, more wiring harness slack can be attained by detaching the tie strap push pin (1) located further under the IP.

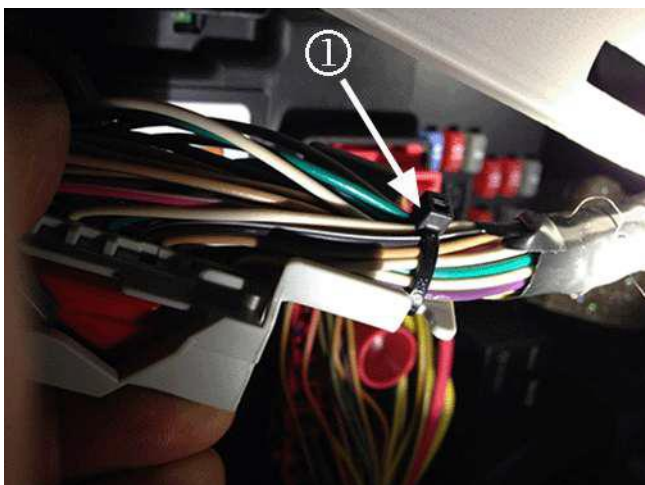

4234863

4. To allow for installation of the tie strap added in the next step, remove the existing tie strap (1) from the end of the connector.

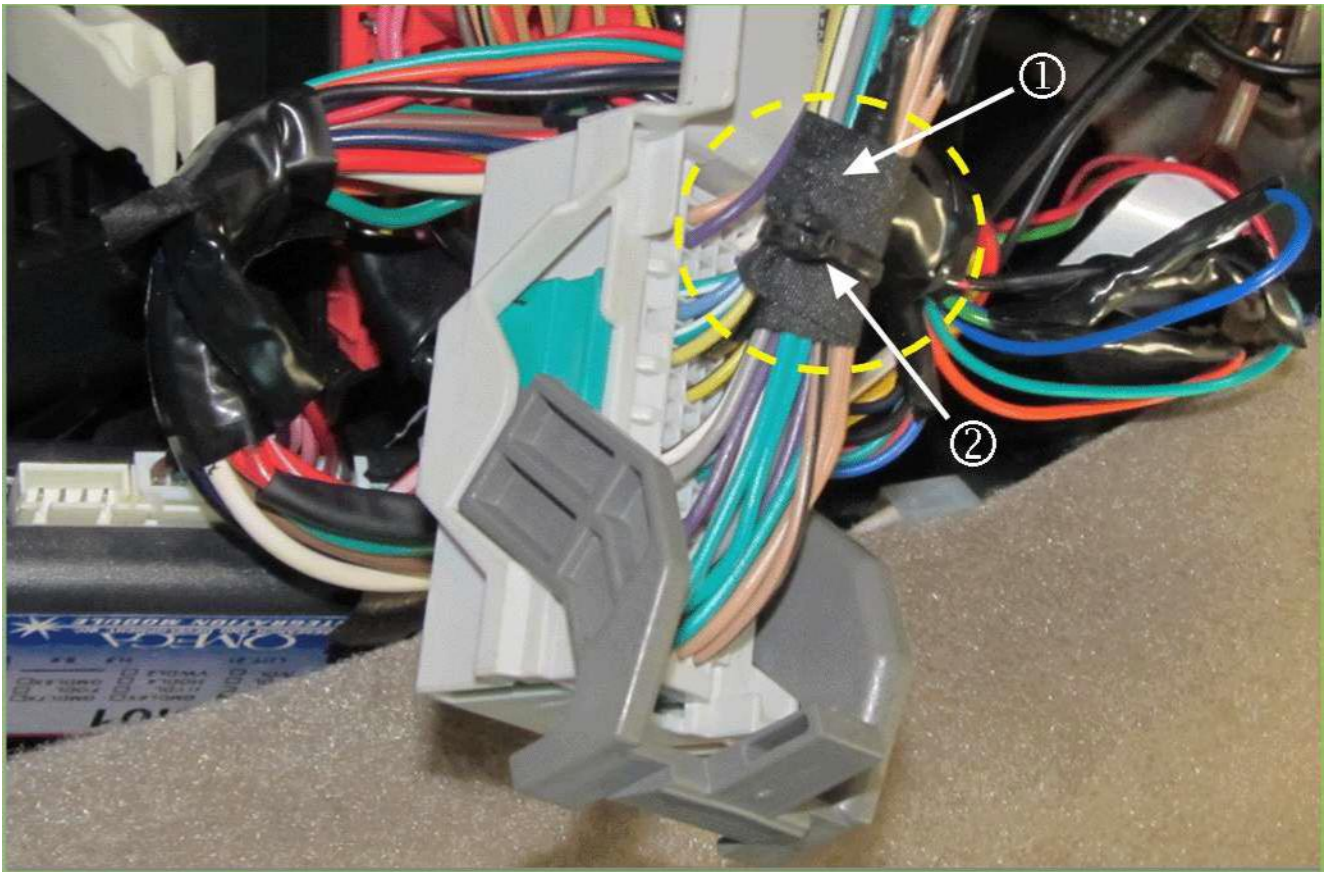

3963132

5. Install Kent Automotive non-abrasion Woven Polyester Electrical Tape (PET) (1) and a new (short) tie strap (2) to the wiring within the BCM connector bundle. You will not be able to tie strap the complete bundle of wiring; exclude approximately the first three rows of the wiring bundle.

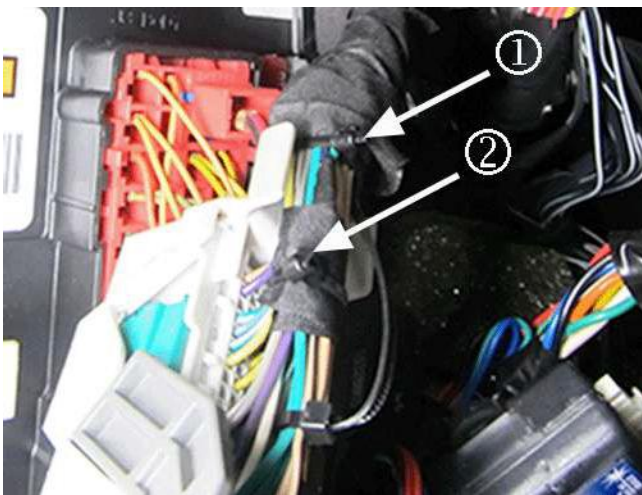

4234876

6. Once the additional short tie strap (2) is added, apply PET and install a new long tie strap (1) at the location where original tie strap was removed.

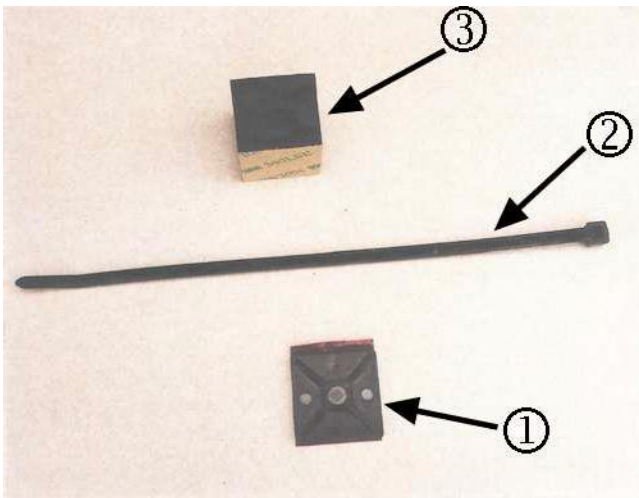

3963139

Note: Carefully read and follow the instructions below.

- **For Pontiac G6, Saturn AURA and 2008-2012 Chevrolet Malibu models**, the new tie-down mount (1) P/N 13596990, tie strap (2) P/N 11509086 and rubber spacer (3) P/N 13596991 will be added to secure the harness at the upper forward corner of the BCM. The technician should continue on to step # 7.
- **For 2004-2007 Chevrolet Malibu Sedan and Maxx and 2008 Chevrolet Malibu Classic models**, skip step # 7 and proceed to step # 8. For these vehicles, the tie-down mount (1) will be installed in a different location and the rubber spacer (3) WILL NOT be needed.

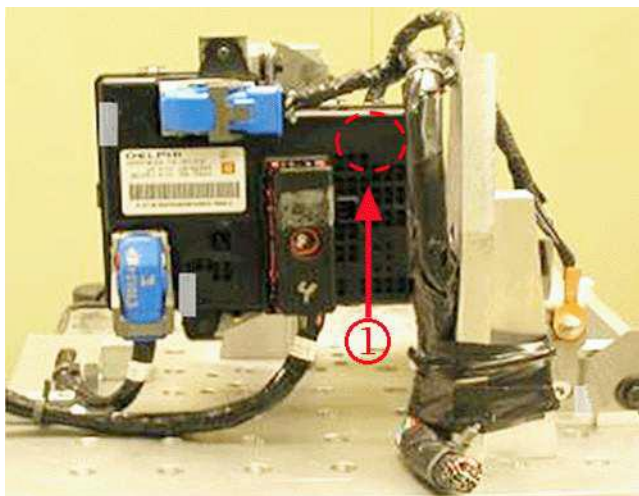

3963147

7. For the specific models noted above, install the new tie down clip to the outboard, upper forward corner (1) of the BCM housing.
 - 7.1. Carefully apply GM Plastic Adhesion Promoter P/N 12378462 (In Canada use GM 10953554) to the upper forward of the BCM.

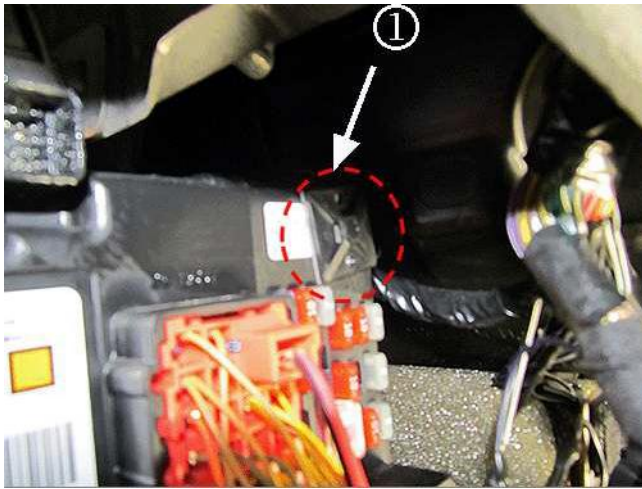

3963151

Note: Ensure the orientation of the clip is such that the slot is in the vertical direction to accept the tie strap.

7.2. Peel the backing from the adhesive on the tie down clip (1) and install the mount to the BCM. Let the promoter and adhesive set up while applying the dielectric lubricant and tape.



3963156

Note: Use an applicator stick, or equivalent, to collect a 10 mm x 10 mm x 10 mm dab of dielectric grease from the tub, and apply it to the terminal/cavity of the connector.

8. Apply the dielectric lubricant (clear gel), GM P/N 12377900 (in Canada, use P/N 10953529), completely across all of the terminal pins in the BCM.



3684288

9. Use a one-inch nylon bristle brush to spread the lubricant evenly onto all terminal pins.
10. Again using the applicator stick, apply a 10 mm dab of dielectric lubricant completely across the connector face of the BCM connector.

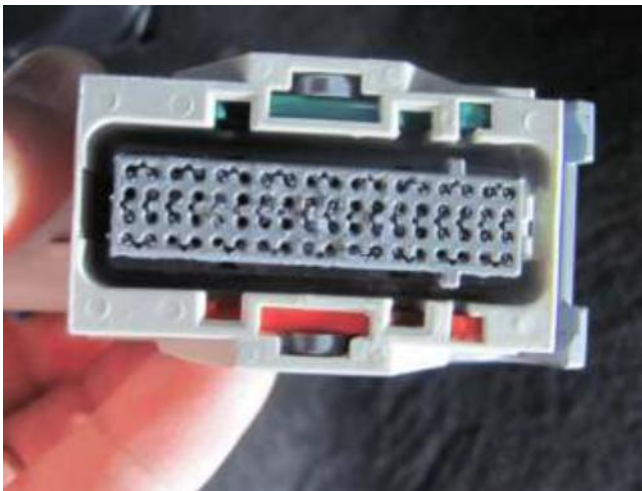

3684286

11. Use a one-inch nylon bristle brush to spread the lubricant evenly into all terminal holes.
12. Reinstall the blue latch cover to the connector, reconnect the connector back on the BCM and re-latch.
13. Unlatch the connector and disconnect the connector from the BCM.



3963156

14. Apply a second 10 mm dab of dielectric lubricant completely across all of the BCM connector cavity terminal pins.

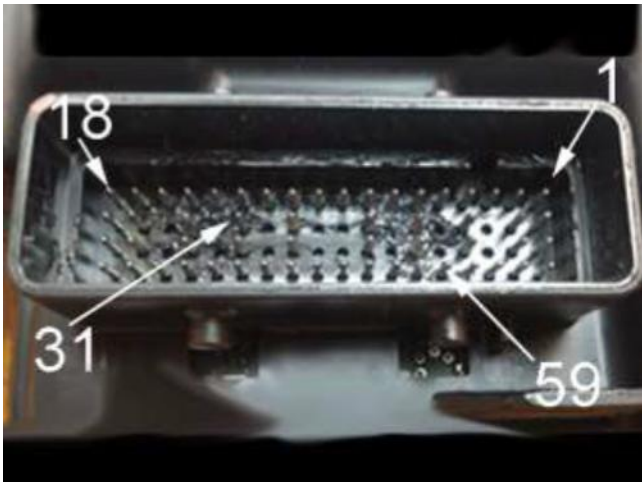

3763821

15. Use a one-inch nylon bristle brush to spread the lubricant evenly onto all terminal pins. Verify that terminal pins 18, 31, & 59 are thoroughly coated.
16. Apply a second 10 mm dab of dielectric lubricant completely across the connector face of the BCM connector.

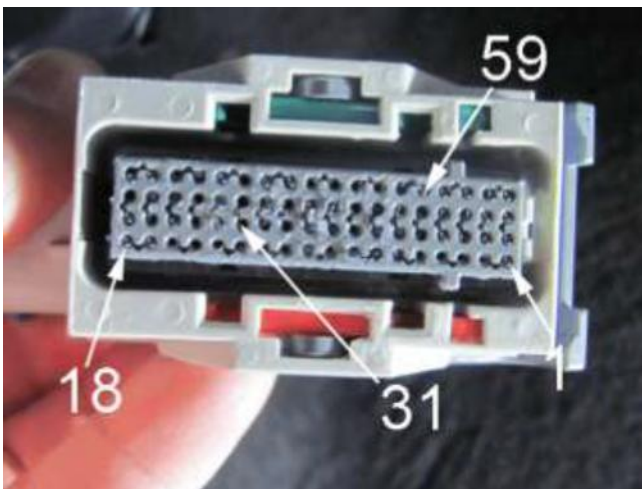

3763832

17. Use a one-inch nylon bristle brush to spread the lubricant evenly into all terminal holes. Verify that terminal locations 18, 31, & 59 are thoroughly coated.
18. Reconnect the connector back on the BCM and re-latch. Wipe away any excess lubricant.
19. Apply Kent Automotive non-abrasion PET to the BCM harness, covering the tie strap just outside the C2 or X2 connector, and extending to 25 mm (1 in) past the forward corner of the BCM as shown.



3963163

Note: The photo above is for Pontiac G6, Saturn AURA and 2008-2012 Chevrolet Malibu models.

20. Depending on vehicle model, follow the appropriate BCM harness tie strap installation below:
 - **For Pontiac G6, Saturn AURA and 2008-2012 Chevrolet Malibu models,** stack the new rubber spacer (2) on top of the tie-down mount (3) (installed previously), position the BCM harness across the spacer, install the long tie strap (4) through the slot on the mount and carefully cinch the tie strap.

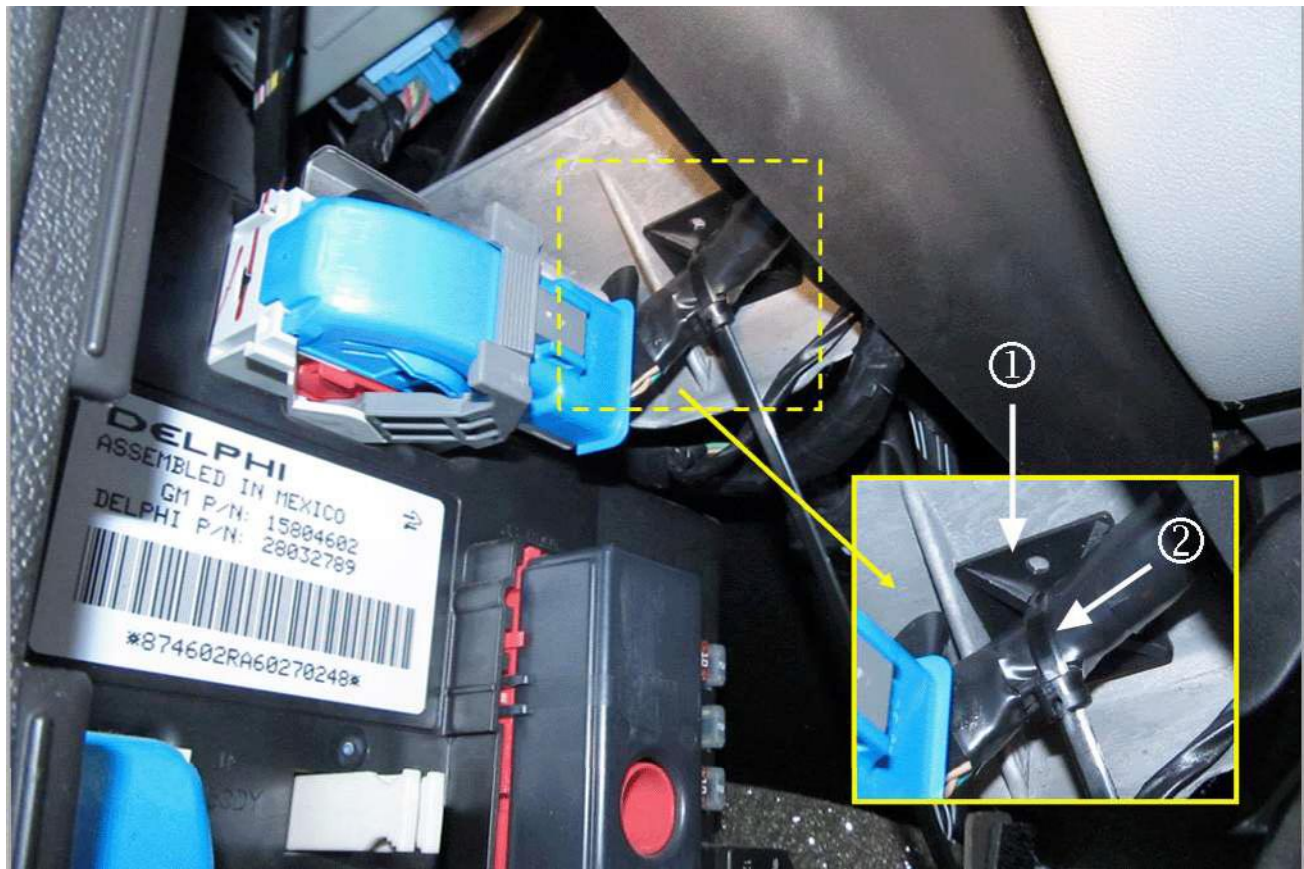

3963167

Note: The photo above is for 2004-2007 Chevrolet Malibu Sedan and Maxx, and 2008 Chevrolet Malibu Classic models.

- **For 2004-2007 Chevrolet Malibu Sedan and Maxx, and 2008 Chevrolet Malibu Classic models**, peel the backing from the adhesive on the tie-down mount and install the mount (1) to the flat underside surface of IP Mag Beam, in the location shown in the graphic above. DO NOT install the rubber spacer on the mount; just position the harness to the mount, install the long tie strap (2) through the slot on the mount and carefully cinch the tie strap.

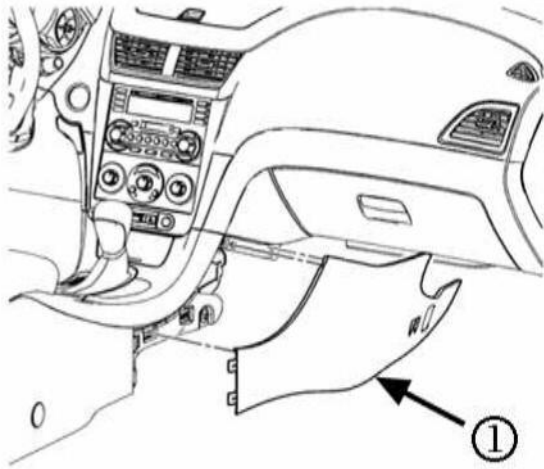

3963121

21. Reinstall the right side front floor console side trim panel (1).

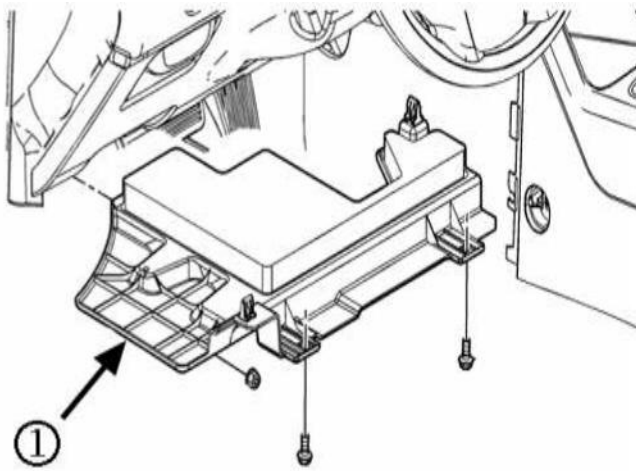

3963176

22. Remove the driver side instrument panel insulator panel (1). Refer to Instrument Panel Insulator Replacement - Left Side in SI.

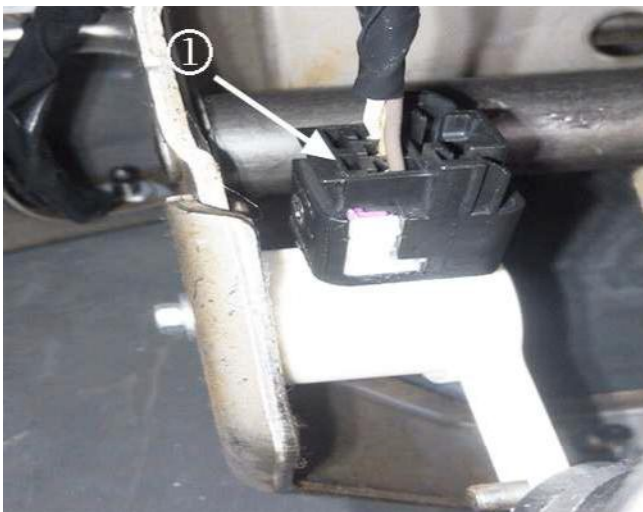

3963182

23. Disconnect the Brake Pedal Position Sensor (BPPS) connector (1).



3963189

24. Using the applicator stick, apply a smaller 5 mm x 5 mm x 5 mm dab of dielectric lubricant completely across all of the terminal pins in the BPPS connector cavity.



3963193

25. Use a one-inch nylon bristle brush to spread the lubricant evenly onto all terminal pins.



3963197

26. Apply a 5 mm x 5 mm x 5 mm dab of dielectric lubricant completely across the connector face of the BPPS connector.

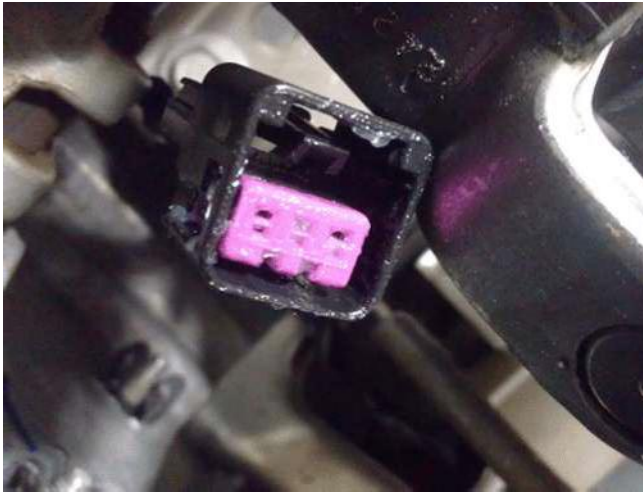

3963201

27. Use a one-inch nylon bristle brush to spread the lubricant evenly into all terminal holes.
28. Reconnect the connector back on the BPPS.
29. Disconnect the connector from the BPPS.



3963189

30. Apply a second 5 mm x 5 mm x 5 mm dab of dielectric lubricant completely across all of the BPPS connector cavity terminal pins.



3963193

31. Use a one-inch nylon bristle brush to spread the lubricant evenly onto all terminal pins. Verify that the terminal pins are thoroughly coated.
32. Apply a second 5 mm x 5 mm x 5 mm dab of dielectric lubricant completely across the connector face of the BPPS connector.

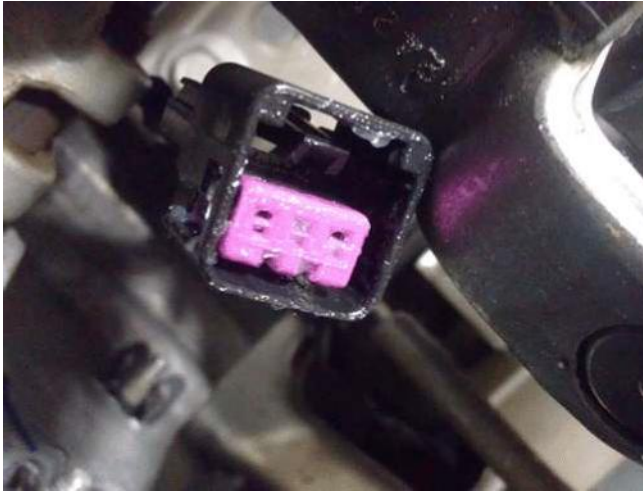

3963201

33. Use a one-inch nylon bristle brush to spread the lubricant evenly into all terminal holes. Verify the terminal locations are thoroughly coated.
34. Reconnect the connector back on the BPPS. Wipe away any excess lubricant.
35. Perform the brake pedal position sensor calibration. Refer to [Brake Pedal Position Sensor Calibration](#) in SI.

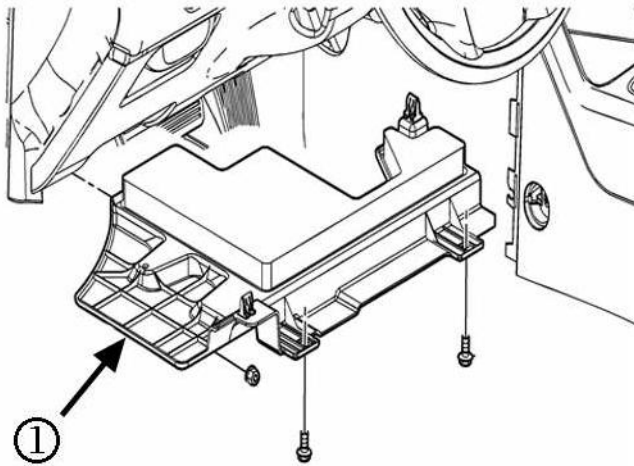

3963176

36. Reinstall the driver side instrument panel insulator panel (1). Refer to Instrument Panel Insulator Replacement - Left Side in SI.
37. Verify proper operation of the brake lights.

CUSTOMER REIMBURSEMENT - For U.S.

Customer requests for reimbursement of previously paid repairs for the recall condition are to be submitted to the dealer by August 31, 2015, unless otherwise specified by state law. If this is not convenient for the customer, they may mail the completed Customer Reimbursement Request Form and all required documents to the GM Customer Assistance Center.

All reasonable and customary costs to correct the condition described in this bulletin should be considered for reimbursement. Any questions or concerns should be reviewed with your GM representative prior to processing the request.

When a customer requests reimbursement, they must provide the following:

- A completed Customer Reimbursement Request Form. This form is mailed to the customer or can be obtained through GM GlobalConnect.
- The name and address of the person who paid for the repair.
- Paid receipt confirming the amount of the repair expense, a description of the repair, and the person or entity performing the repair.

IMPORTANT: GM requires dealers to approve or deny a reimbursement request within 30 days of receipt. If a reimbursement request is approved, the dealer should immediately issue a check to the customer and submit an appropriate warranty transaction for the incurred expense. If a reimbursement request is denied, the dealer **MUST** provide the customer with a clear and concise explanation, in writing, as to why the request was denied. The bottom portion of the Customer Reimbursement Request Form may be used for this purpose. If the denial was due to missing documents, the customer can resubmit the request when the missing documents are obtained, as long as it is still within the allowed reimbursement period.

Warranty transactions for customer reimbursement of previously paid repairs are to be submitted as required by GM Global Warranty Management. Additional information can also be found in Warranty Administration Bulletin 11-00-89-004.

CUSTOMER REIMBURSEMENT - For Canada and Export

Customer requests for reimbursement of previously paid repairs to correct the condition described in this bulletin are to be submitted to the dealer prior to or by August 31, 2015.

When a customer requests reimbursement, they must provide the following:

- Proof of ownership at time of repair.
- Original paid receipt confirming the amount of unreimbursed repair expense(s) (including Service Contract deductibles), a description of the repair, and the person or entity performing the repair.

All reasonable and customary costs to correct the condition described in this bulletin should be considered for reimbursement. Any questions or concerns should be reviewed with your GM representative prior to processing the request.

COURTESY TRANSPORTATION – For U.S. and Canada

The General Motors Courtesy Transportation program is intended to minimize customer inconvenience when a vehicle requires a repair that is covered by the New Vehicle Limited Warranties. The availability of courtesy transportation to customers whose vehicles are within the warranty coverage period and involved in a product program is very important in maintaining

customer satisfaction. Dealers are to ensure that these customers understand that shuttle service or some other form of courtesy transportation is available and will be provided at no charge. Dealers should refer to the General Motors Service Policies and Procedures Manual for Courtesy Transportation guidelines.

WARRANTY TRANSACTION INFORMATION

Submit a transaction using the table below. All transactions should be submitted as a ZFAT transaction type, unless noted otherwise.

Note: To avoid having to "H" route the customer reimbursement transaction for approval, it must be submitted prior to the repair transaction.

Labor Code	Description	Labor Time	Net Item
9100810	BCM and BPPS Harness and Connector Repair	0.4	*
9100822	Customer Reimbursement Approved	0.2	**
9100823	Customer Reimbursement Denied - For U.S. dealers only	0.1	N/A

Note: Customer reimbursement will not close this recall. The service procedure must also be performed on the vehicle.

- * The amount identified in "Net Item" should represent the actual sum total of the current dealer net price for the plastic Adhesion Promoter, Dielectric Lubricant and Woven Polyester Electrical Tape needed to perform the required repair, not to exceed 98¢ USD/CAD, plus applicable Mark-Up or Landed Cost (for Export).
- ** The amount identified in "Net Item" should represent the dollar amount reimbursed to the customer.

CUSTOMER NOTIFICATION – For U.S. and Canada

General Motors will notify customers of this recall on their vehicle (see copy of customer letter included with this bulletin).

CUSTOMER NOTIFICATION – For Export

Letters will be sent to known owners of record located within areas covered by the US National Traffic and Motor Vehicle Safety Act. For owners outside these areas, dealers should notify customers using the attached sample letter.

DEALER RECALL RESPONSIBILITY – For U.S. and Export (U.S. States, Territories, and Possessions)

It is a violation of Federal law for a dealer to deliver a new motor vehicle or any new or used item of motor vehicle equipment (including a tire) covered by this notification under a sale or lease until the defect or noncompliance is remedied.

The US National Traffic and Motor Vehicle Safety Act provides that each vehicle that is subject to a recall of this type must be adequately repaired within a reasonable time after the customer has tendered it for repair. A failure to repair within sixty days after tender of a vehicle is prima facie evidence of failure to repair within a reasonable time. If the condition is not adequately repaired within a reasonable time, the customer may be entitled to an identical or reasonably equivalent vehicle at no charge or to a refund of the purchase price less a reasonable allowance

for depreciation. To avoid having to provide these burdensome remedies, every effort must be made to promptly schedule an appointment with each customer and to repair their vehicle as soon as possible. In the recall notification letters, customers are told how to contact the US National Highway Traffic Safety Administration if the recall is not completed within a reasonable time.

DEALER RECALL RESPONSIBILITY – All

All unsold new vehicles in dealers' possession and subject to this recall must be held and inspected/repaired per the service procedure of this recall bulletin before customers take possession of these vehicles.

Dealers are to service all vehicles subject to this recall at no charge to customers, regardless of mileage, age of vehicle, or ownership, from this time forward.

Customers who have recently purchased vehicles sold from your vehicle inventory, and for which there is no customer information indicated on the dealer listing, are to be contacted by the dealer. Arrangements are to be made to make the required correction according to the instructions contained in this bulletin. A copy of the customer letter is provided in this bulletin for your use in contacting customers. Recall follow-up cards should not be used for this purpose, since the customer may not as yet have received the notification letter.

In summary, whenever a vehicle subject to this recall enters your vehicle inventory, or is in your dealership for service in the future, you must take the steps necessary to be sure the recall correction has been made before selling or releasing the vehicle.



IMPORTANT SAFETY RECALL

August 2014

Dear General Motors Customer:

This notice is sent to you in accordance with the National Traffic and Motor Vehicle Safety Act.

General Motors has decided that a defect which relates to motor vehicle safety exists in 2004-2012 model year (MY) Chevrolet Malibu, 2004-2007 MY Chevrolet Malibu Maxx, 2005-2010 MY Pontiac G6, 2007-2010 MY Saturn Aura vehicles. As a result, GM is conducting a safety recall. We apologize for this inconvenience. However, we are concerned about your safety and continued satisfaction with our products.

IMPORTANT

- This notice applies to your vehicle.
- Your vehicle is involved in GM safety recall 13036.
- Schedule an appointment with your GM dealer.
- This service will be performed for you at **no charge**.

Why is your vehicle being recalled?

On these vehicles, over time an increased resistance can develop in the Body Control Module (BCM) connection system and result in voltage fluctuations or intermittency in the Brake Apply Sensor (BAS) circuit that can cause service brake lamp malfunction. As a result, the service brake lamps may illuminate when the service brakes are not being applied, or may not illuminate when the service brakes are being applied. Additionally, cruise control may not engage. If cruise control is engaged, additional service brake pedal travel may be required to disengage it. Service brake pedal application may not be required to move the shift lever out of PARK, or additional service brake pedal travel may be required to move the shift lever out of PARK. Traction control, electronic stability control, and panic braking assist features, if equipped, may be disabled. Service ESC and/or Traction Control tell-tales may illuminate with this condition. These conditions may increase the risk of a crash.

What will we do?

Your GM dealer will attach your vehicle's wiring harness to the BCM with a spacer, apply dielectric lubricant to both the BCM and harness connector and on the BAS and harness connector, and relearn the brake pedal home position. This service will be performed for you at **no charge**. Because of service scheduling requirements, it is likely that your dealer will need your vehicle longer than the actual service correction time of approximately 20 minutes.

What should you do?

You should contact your GM dealer to arrange a service appointment as soon as possible.

Did you already pay for this repair?

Even though you may have already had repairs for this condition corrected, you will still need to take your vehicle to your dealer for additional repairs. If you have paid for repairs for the recall condition, please complete the enclosed reimbursement form and present it to your dealer with all required documents. Working with your dealer will expedite your request, however, if this is not convenient, you may mail the completed reimbursement form and all required documents to Reimbursement Department, PO Box 33170, Detroit, MI 48232-5170. The completed reimbursement form and required documents must be presented to your dealer or received by the Reimbursement Department by August 31, 2015, unless state law specifies a longer reimbursement period.

Do you have questions?

If you have questions or concerns that your dealer is unable to resolve, please contact the appropriate Customer Assistance Center at the number listed below.

Division	Number	Text Telephones (TTY)
Chevrolet	1-800-222-1020	1-800-833-2438
Pontiac	1-800-762-2737	1-800-833-7668
Saturn	1-800-553-6000	1-800-833-6000
Guam	65-6267-1752	
Puerto Rico – English	1-800-496-9992	
Puerto Rico – Español	1-800-496-9993	
Virgin Islands	1-800-496-9994	

If after contacting your dealer and the Customer Assistance Center, you are still not satisfied we have done our best to remedy this condition without charge and within a reasonable time, you may wish to write the Administrator, National Highway Traffic Safety Administration, 1200 New Jersey Avenue, SE, Washington, DC 20590, or call the toll-free Vehicle Safety Hotline at 1.888.327.4236 (TTY 1.800.424.9153), or go to <http://www.safercar.gov>. The National Highway Traffic Safety Administration Campaign ID Number for this recall is 14V252.

Federal regulation requires that any vehicle lessor receiving this recall notice must forward a copy of this notice to the lessee within ten days.

Jim Moloney
General Director,
Customer and Relationship Services

Enclosure
GM Recall Number: 13036