



RECALL CAMPAIGN BULLETIN

Reference:

NTB14-006

Date:

February 18, 2014

VOLUNTARY SAFETY RECALL CAMPAIGN 2012 – 2014 FRONTIER CIRCUIT BREAKER

CAMPAIGN ID #: PC259

APPLIED VEHICLES: 2012 - 2014 Frontier (D40)

Check Service COMM to confirm campaign eligibility.

INTRODUCTION

Nissan is conducting a Voluntary Safety Recall Campaign on certain specific 2012 – 2014 Model Year Frontier vehicles to inspect the Circuit Breaker-2 for proper installation. If necessary, the Circuit Breaker-2 will be reinstalled. If the main wire harness near Circuit Breaker-2 is damaged, it will be repaired, and if necessary, replaced. This service will be performed at no charge to owners for parts or labor.

IDENTIFICATION NUMBER

Nissan has assigned identification number PC259 to this campaign. This number must appear on all communications and documentation of any nature dealing with this campaign.

DEALER RESPONSIBILITY

It is the dealer's responsibility to check Service Comm for the campaign status on each vehicle falling within the range of this voluntary safety recall campaign which for any reason enters the service department. This includes vehicles purchased from private parties or presented by transient (tourist) owners and vehicles in a dealer's inventory. **Federal law requires that new vehicles in dealer inventory which are the subject of a safety recall must be corrected prior to sale. Failure to do so can result in civil penalties by the National Highway Traffic Safety Administration.** While federal law applies only to new vehicles, Nissan strongly encourages dealers to correct any used vehicles in their inventory before they are retailed.

Nissan Bulletins are intended for use by qualified technicians, not 'do-it-yourselfers'. Qualified technicians are properly trained individuals who have the equipment, tools, safety instruction, and know-how to do a job properly and safely. NOTE: If you believe that a described condition may apply to a particular vehicle, DO NOT assume that it does. See your Nissan dealer to determine if this applies to your vehicle.

SERVICE PROCEDURE

1. Make sure the ignition is OFF.

2. Set the parking brake.

3. Pull the driver door welt loose in the area shown.



Figure 1

4. Snap loose and remove the front pillar lower finisher.

- Use a plastic trim tool as needed.

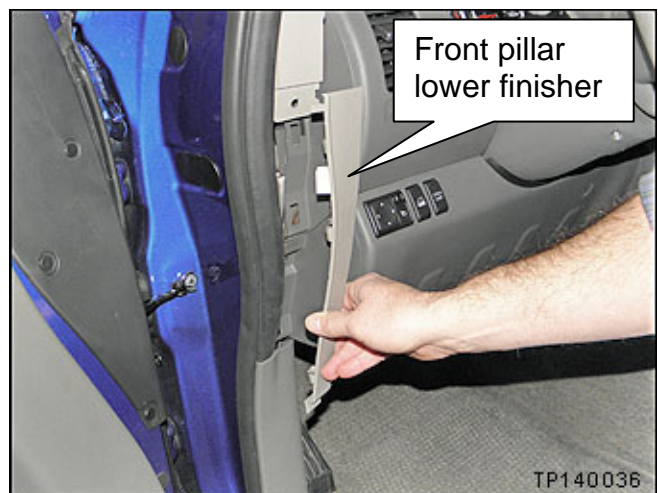

Figure 2

5. Remove the 2 screws shown in Figure 3.

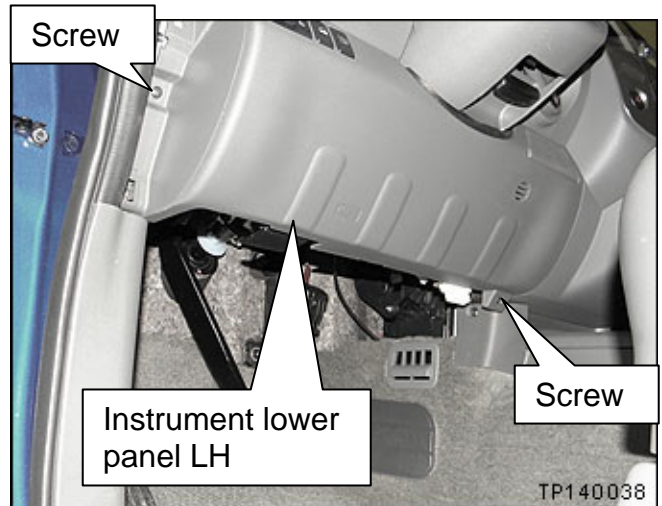

Figure 3

6. Carefully snap loose the instrument lower panel LH.
- Use a plastic trim tool as needed.
 - Let the panel hang in place. It does not need to be completely removed.

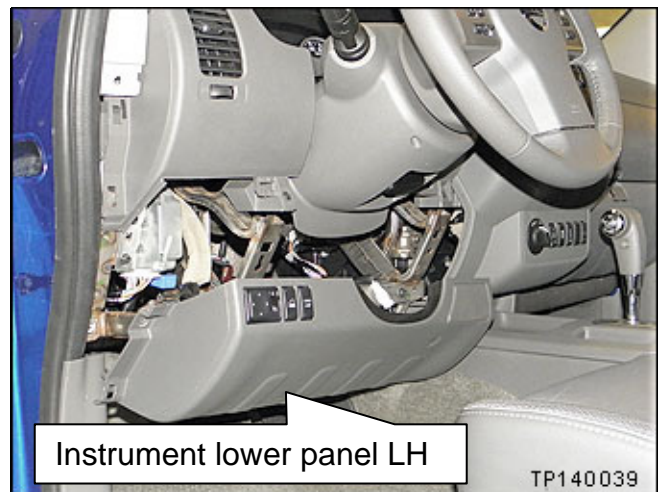

Figure 4

7. Look under the instrument panel where shown in Figure 5.
8. Locate Circuit Breaker-2.
- Circuit Breaker-2 is gray in color and looks like a relay.
 - See the next page for additional photos of Circuit Breaker-2.

NOTE: Only 4WD models have a transfer control unit.

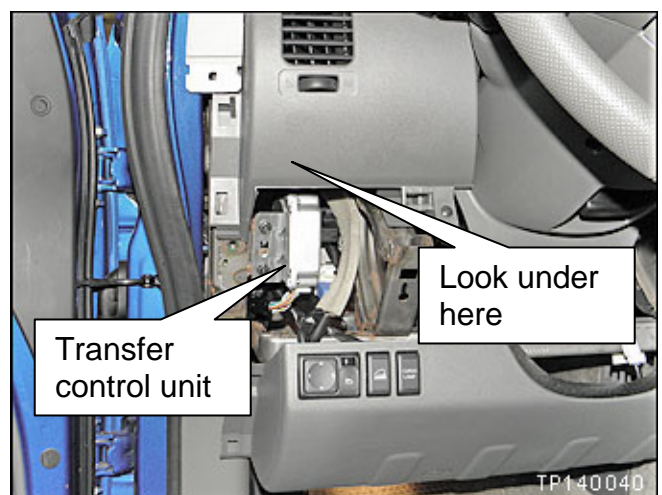

Figure 5

IMPORTANT: Some vehicles will not be equipped with a Circuit Breaker-2. In this case the procedure is complete. No further action is needed.

9. Inspect the orientation/installation of Circuit Breaker-2.

OK: If it is installed as shown in Figure 6, no further action is needed.

NG: If it is installed as shown in Figure 7, continue with this procedure.

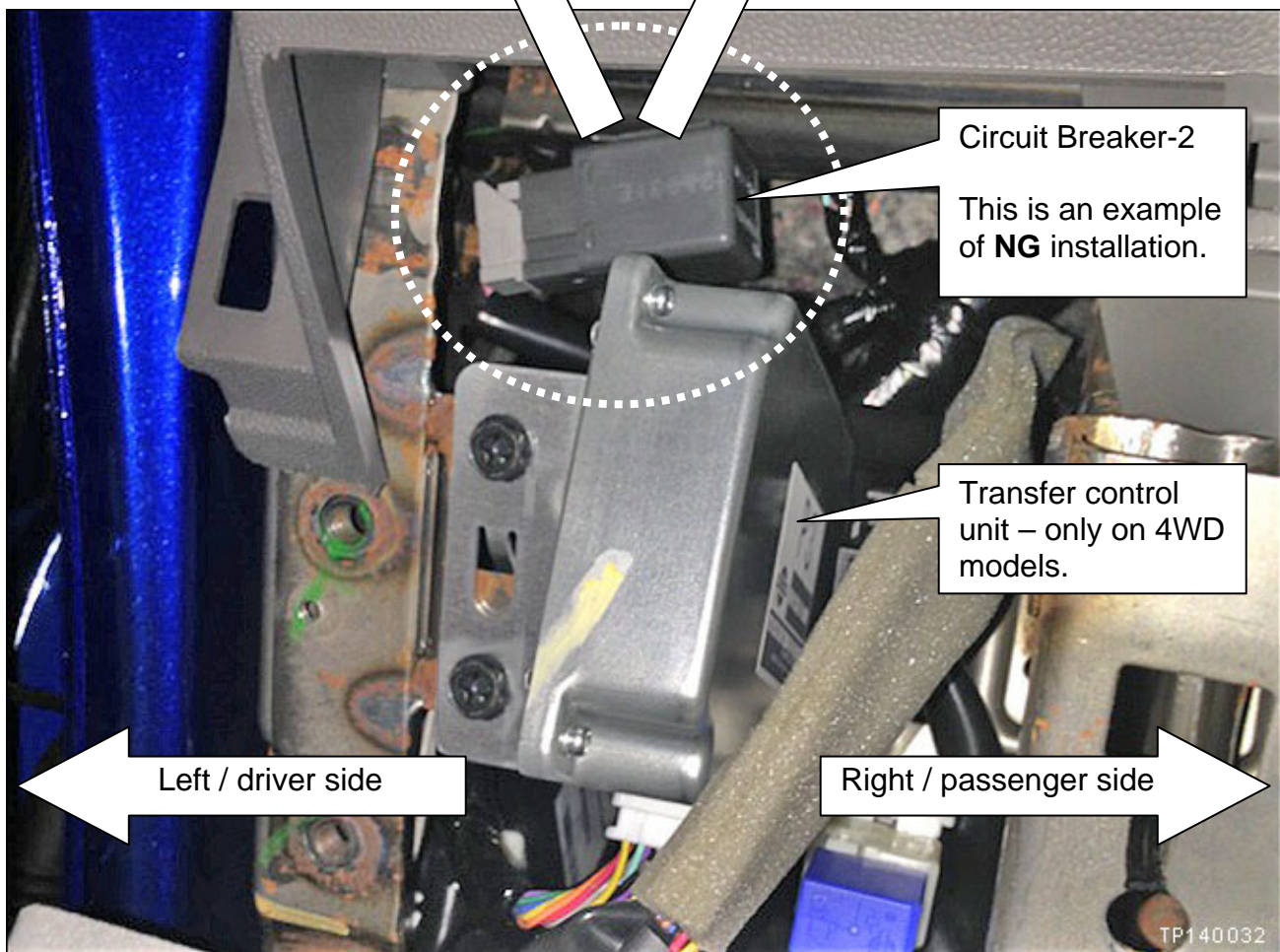
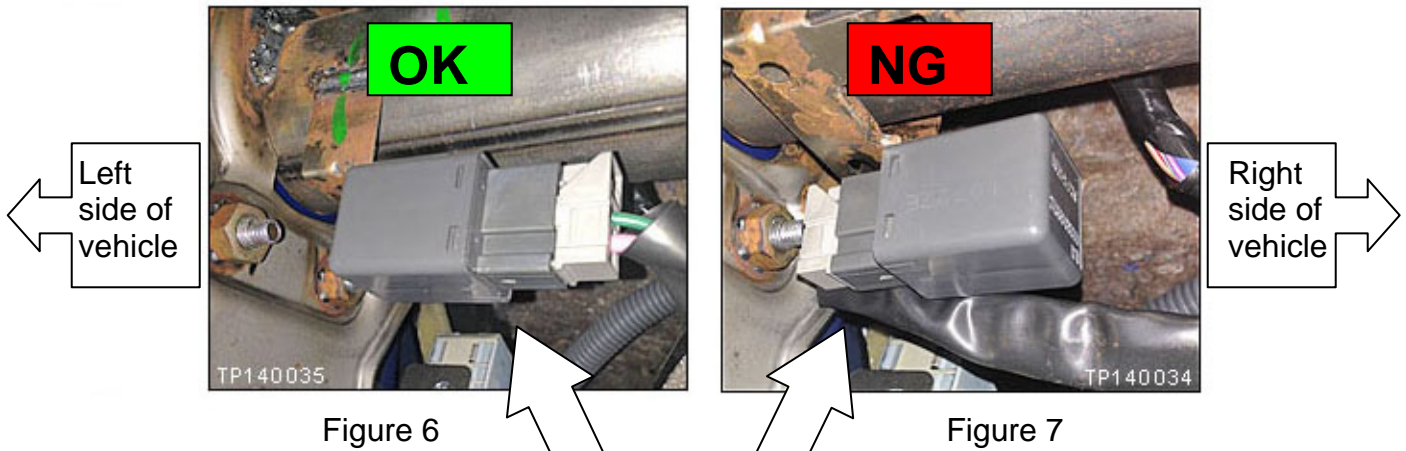

Figure 8

NOTE: In step 10, **DO NOT** unplug/disconnect the transfer control unit.

10. For 4WD models: Remove the 2 mounting bolts for the transfer control unit and position the control unit out of the way.

- Do not unplug/disconnect the transfer control unit.

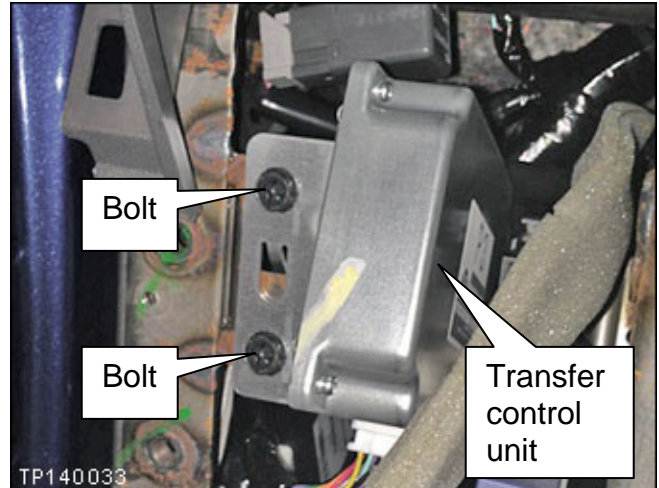

Figure 9

11. Slide Circuit Breaker-2 off of its mounting bracket.

- Slide it towards the right side of the vehicle.

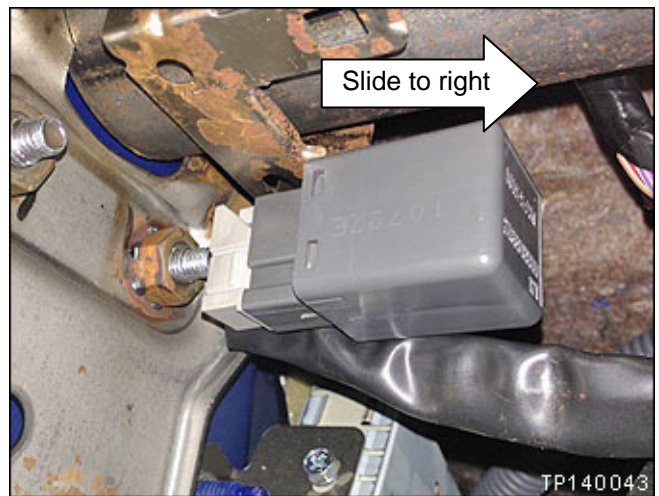

Figure 10

12. Inspect the wires at the Circuit Breaker-2 connector (see Figure 11).

If there are no marks on the wire insulation:

- Go to the next step.

If wire insulation has trauma (rubbed, chaffed):

- a. Cover the trauma area with electrical tape.
 - Take care not to bend the wires excessively to avoid breaking the wire core.
- b. Go to the next step.

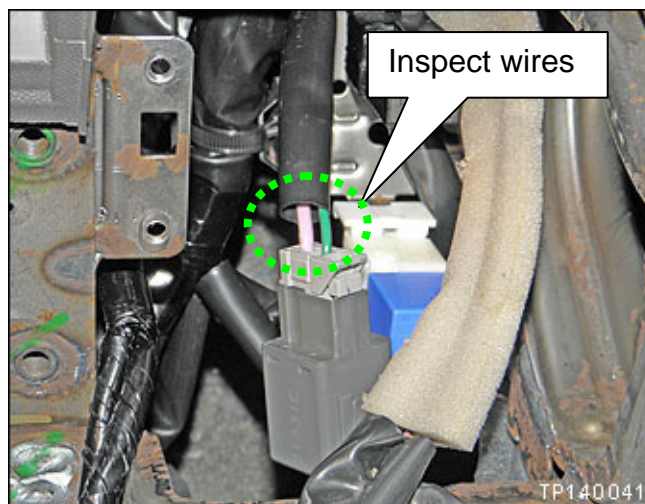

Figure 11

If the wire trauma cannot to be repaired with electrical tape (wire core is exposed); see instruction on the next page.

13. Reinstall Circuit Breaker-2 as shown in Figure 12.

- **Make sure connector/wires are facing towards the right side of the vehicle as shown.**
- **Make sure Circuit Breaker-2 is installed/positioned on the bracket as shown.**

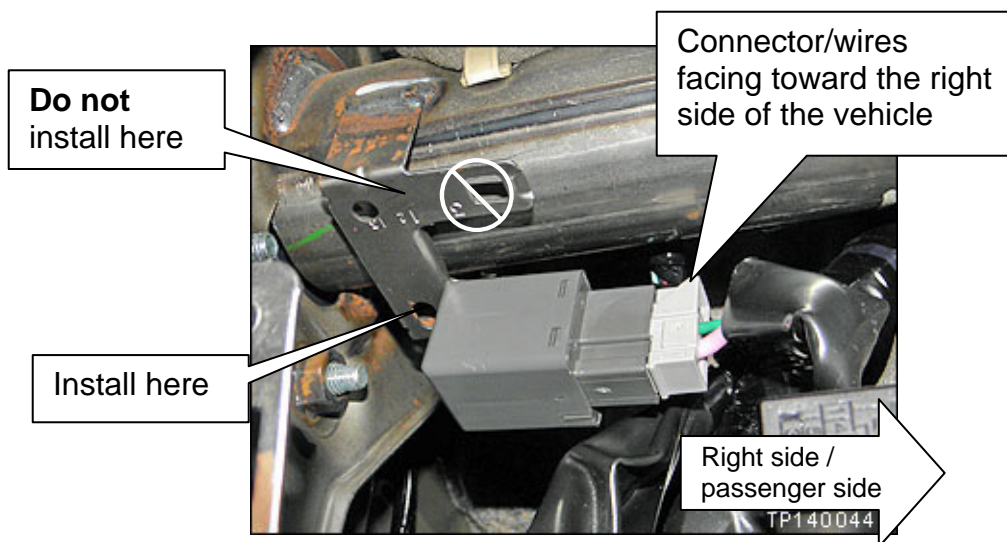

Figure 12

14. Reinstall all other removed parts in reverse order.

If the wire trauma cannot to be repaired with electrical tape (wire core is exposed):

- Send an email to nafqasupport@nissan-usa.com
- Include in the email:
 - Photo of the wire trauma**
 - Dealer contact name and phone number**
 - Dealer code**
 - Dealer name**
 - VIN**
- Nissan will respond within 24 hours with additional instructions.

CLAIMS INFORMATION

CAMPAIGN (“CM”) I.D.	DESCRIPTION	OP CODE	FRT
PC259	Inspect circuit breaker orientation and harness wires. If necessary, correct orientation and apply electrical tape to harness wires.	PC2592	0.2 hr

