

ISUZU

Campaign Service BULLETIN

IMPORTANT SERVICE INFORMATION FOR:

- ✓ SERVICE MANAGER
- ✓ SERVICE ADVISOR
- ✓ TECHNICIAN
- ✓ PARTS DEPARTMENT
- ✓ WARRANTY PERSONNEL

BULLETIN NUMBER:
SB13-11-S001

ISSUE DATE:
DECEMBER 2013

GROUP:
BODY

Regional Safety Recall 13V-547

The logo consists of a black triangle pointing to the right, with the letters 'LV' in white inside it.

Corrosion Affecting the Forward Mounting Point for Rear Suspension Lower Link Brackets

AFFECTED VEHICLES

- 2003-2004MY Isuzu Rodeo (UE)
- 2003-2004MY Isuzu Axiom (UP)
- 2003MY Isuzu Rodeo Sport (UA)

SERVICE INFORMATION

CONDITION

Isuzu Motors America, LLC has announced a Safety Recall on 2003-2004 Rodeo and Axioms, and 2003 Rodeo Sports originally or currently registered in the following states: Connecticut, Delaware, Illinois, Indiana, Iowa, Maine, Maryland, Massachusetts, Michigan, Minnesota, Missouri, New Hampshire, New Jersey, New York, Ohio, Pennsylvania, Rhode Island, Vermont, West Virginia, Wisconsin, Kentucky, and the District of Columbia (the "Salt Belt States"). This recall applies to the forward rear suspension link bracket area of the subject vehicles. The subject Isuzu vehicles that have experienced sustained exposure to highly corrosive materials used in some jurisdictions for road deicing purposes may experience excessive corrosion in the vicinity of the forward mounting point bracket for the left or right rear suspension lower link prematurely. In certain extreme cases, excessive corrosion in this vicinity may result in a lower link bracket becoming detached from the frame, which can affect vehicle handling and potentially cause a crash.

CORRECTION

The remedy involves an inspection process, typically followed by one of four available repair procedures, depending on the extent of corrosion damage to the lower link bracket area.

SERVICE FACILITY RESPONSIBILITY

Whenever a subject vehicle is presented to the Service Facility for service work, the Service Facility must take the necessary steps to ensure that this campaign has been completed prior to releasing the vehicle. Service Facilities are to inspect all eligible vehicles per the procedure attached. For vehicles in which there is little or no corrosion evident, the Service Facility should treat the affected area as noted in this bulletin (Conditions One and Two). For vehicles in which corrosion has damaged the area around either of the forward mounting point brackets of the rear suspension lower link or affected their connection to the frame, Service Facilities should treat the affected area and install the appropriate reinforcement brackets, as further explained in this bulletin (Conditions Three and Four).

For subject Axioms, Rodeos and Rodeo Sports up to 10 years old as of November 1, 2013, all Service Facilities should provide this inspection and the appropriate remedy **free of charge**.

For subject Axioms, Rodeos and Rodeo Sports **over 10 years old as of November 1, 2013**, all Service Facilities should provide this inspection and the appropriate remedy **free of charge for one year from the date of owner notification**.

It is the Service Facility's responsibility to validate the eligibility of each specific vehicle by using the Isuzu Communications System (ICS), isuzuone.com, or by calling the Service Facility Support Line at 1-800-533-0244 (Option 2).

Service Facilities will also be provided an Affected Vehicle Campaign Report (AWS123) via the Isuzu Communications System (ICS). This report contains VIN and detailed owner information obtained from state motor vehicle registration records. The use of such motor vehicle registration data for any other purpose is not allowed and improper use may violate State and Federal laws.

If any Service, Parts, or Warranty personnel at your Facility have questions or do not understand the requirements of this Regional Safety Recall, they are encouraged to contact one of our National Operation Managers at our Service Facility Support Line (1-800-533-0244, Option 2).

OWNER NOTIFICATION

Owner notification will take place December 6, 2013. Isuzu Motors America, LLC will be notifying owners of subject vehicles that were originally registered OR are currently registered in the Salt Belt States of this safety recall. Sample letters for owners of vehicles that were up to 10 years old as of November 1, 2013, and for owners of vehicles that were over 10 years old as of November 1, 2013, are attached at the end of this bulletin.

VEHICLES INVOLVED

2003-2004 Axioms and Rodeos, and 2003 Rodeo Sports originally or currently registered in the following states: Connecticut, Delaware, Illinois, Indiana, Iowa, Maine, Maryland, Massachusetts, Michigan, Minnesota, Missouri, New Hampshire, New Jersey, New York, Ohio, Pennsylvania, Rhode Island, Vermont, West Virginia, Wisconsin, Kentucky, and the District of Columbia.

PARTS INFORMATION

Parts required to complete this campaign are to be obtained from American Isuzu Parts Distribution Network (AIPDN). Please refer to your "involved vehicles listing" before ordering parts. Normal orders should be placed on a Daily Order. In an emergency situation, parts should be ordered on a VOR (Vehicle Off Road) Order.

Part Number	Description	Application	Qty
2-9005D-100-0	Noxudol 300	All	As Required
2-9005D-000-0	Noxudol 700	All	As Required
8-97175-885-0	Hole Plug	All	As Required
8-98181-813-0	Service Kit; Type-A2	Rodeo/Axiom	As Required
8-98181-814-0	Service Kit; Type-B	Rodeo/Axiom	As Required
8-98214-563-0	Service Kit; Type-C2	Rodeo Sport	As Required
8-98214-564-0	Service Kit; Type-D	Rodeo Sport	As Required
2-90028-700-0	Campaign Label	All	As Required
2-90SVA-003-0	Photo Card	All	As Required

SERVICE PROCEDURE

REQUIRED TOOLS: Below are the tools that will be required to complete all procedures in this bulletin. Tools marked with an asterisk "*" will be or have been provided by Isuzu. All others may be substituted with equivalents.

IMPORTANT NOTICE: The tools indicated by an asterisk "*" will be or have been provided at no charge to the Service Facilities in the area covered by this Regional Campaign. If your facility is outside the defined area for this campaign, and an inspection reveals the need for a Category Three or Four repair procedure, please contact the Service Facility Support Line immediately for assistance (1-800-533-0244, Option 2). **REPLACEMENTS FOR LOST OR BROKEN TOOLS WILL BE CHARGED TO THE SERVICE FACILITIES OPEN PARTS ACCOUNT.**

Tools Required for All Repairs:

- Wire Brush
- Scraper
- 12-16oz. Hammer
- 3/16" x 9" Flat Punch
- Air Blow Gun

Tools Required for Conditions Three and Four Repairs:

- Reciprocating Saw and Blades (14 TPI or greater)
- Ratcheting Straps (2)
- 3/8" and 1/2" Drill Motor
- 1/4" Drill Bit
- 9 Inch "C" Clamps (2)
- *1/4" Drill Bit Guide or equivalent (optional method SnapOn E1521 with 3/16" drill bit)
- *33/64 Silver/Deming Drill HSS 118 degree (Grainger P/N 2BT43)
- *Pop-nut Installer w/Regulator
- **For UE, UP:** 4"x4"x7" Wood Blocks (2) and 4"x4"x10.25" Wood Blocks (2)
- **For UA:** 4"x4"x4.75" Wood Blocks (2) and 4"x4"x7.85" Wood Blocks (2)

TOOL PHOTOS:

	
<p>Reciprocating Saw 14 TPI blade</p>	<p>*Pop Nut Installer w/Regulator</p>
	
<p>*1/4" Drill Bit Guide</p>	<p>*33/64" Drill Bit Grainger P/N 2BT43</p>

INSPECTION (ALL VEHICLES)

1. Raise the vehicle. When placing the lift points, be sure to keep the rear lifting points at least 300mm (12 inches) ahead of the rear lower trailing link front mounting bracket. This spacing is necessary for inspection and repair accessibility.
2. Visually inspect the Rear Lower Trailing Link Front Mounting Bracket inspection area. Use the Visual Comparison Photo (P/N 2-90SVA-003-0) or Figure 1 for reference. If most of the frame coating is still in place and very little surface rust is present, apply Noxudol 300 (Go to “Condition One: Apply Noxudol 300” in this bulletin). If most frame coating is missing and excessive rust is present go to the next step.



Figure 1 – Visual Inspection Area

NOTE: If the vehicle is equipped with side steps/running boards, it is necessary to remove them in order to complete the following steps.

3. Using a 3/16” flat punch and a 12-16 oz. hammer, hammer on the locations identified with an “X” in Figure 2. Swing the hammer 10 to 12 inches to be sure enough force is applied to the punch. If no hole is created, apply Noxudol 700 and Noxudol 300 (Go to “Condition Two: Apply Noxudol 700 and Noxudol 300” in this bulletin). If, however, the flat punch creates a hole in any one location, go to the next step.
4. Using a 3/16” flat punch and a 12-16 oz. hammer, hammer on the locations identified with an “X” in Figure 3.
 - a. If no hole is created, continue to Condition Three (reinforcement bracket type “A” or “C”) in this bulletin.
 - b. If the flat punch creates a hole in any one location, continue to Condition Four (reinforcement bracket type “B” or “D”) in this bulletin.

IMPORTANT NOTICE: If there are questions at any point during the Inspection or Repair procedure, please contact one of our National Operations Managers by calling the Service Facility Support line (1-800-533-0244, Option 2). Please have your service facility code and repair order information available when you call.

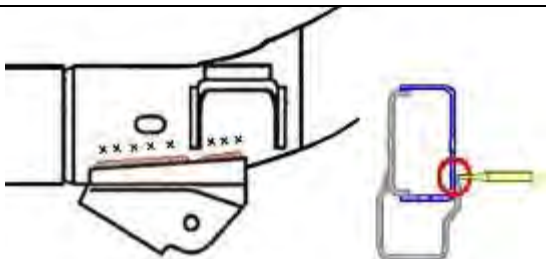

Figure 2 – Step 3 Hammering Locations

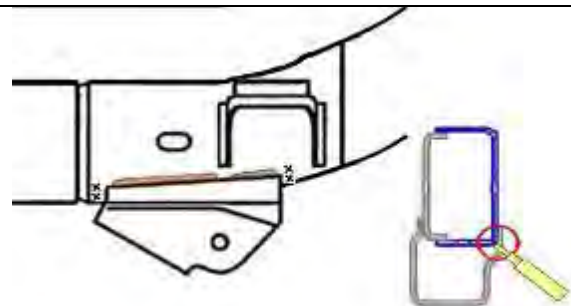

Figure 3 – Step 4 Hammering Locations

CONDITION ONE: APPLY NOXUDOL 300 (ALL VEHICLES)



NOTE: When returning the vehicle to the customer, please inform the customer to avoid high pressure washing of the areas where Noxudol has been applied for up to 72 hours. Refer to the Noxudol can label information for more details.

1. Using a wire brush and scraper remove any loose coating material and rust from the outside frame and rear lower trailing link front mounting bracket area on both driver and passenger sides in the location shown in Figure 4.
2. Using a dry rag remove any remaining dust or debris. If the application area is wet, use a blow gun to remove any water.

CAUTION: Noxudol propellant is highly flammable. Keep away from sources of ignition ~ no smoking. Keep at temperature not exceeding +50°C.

IMPORTANT: Wear hand and eye protection to avoid direct contact. Application should be performed in an area with adequate ventilation. See manufacturer's information for more details.

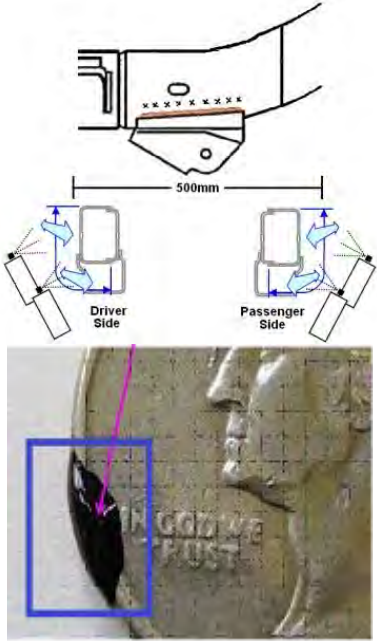
3. Spray one coat of Noxudol 300 onto both driver and passenger side shown in Figures 4 and 5. Be careful not to overspray onto the exhaust system or body painted areas. See Figure 4.
4. Apply the campaign label (see "Applying the Campaign Label" in this bulletin).

	
<p>Figure 4 – Noxudol 300 Application One coat is generally 50 microns which would cover the leading edge of a quarter.</p>	<p>Figure 5 – Noxudol 300 Applied</p>

CONDITION TWO: APPLY NOXUDOL 700 AND NOXUDOL 300 (ALL VEHICLES)

NOTE: When returning the vehicle to the customer, please inform the customer to avoid high pressure washing for 72 hours where Noxudol has been applied. Refer to the Noxudol can label information for more details.

1. Remove the side frame hole plug from the driver and passenger side frame rails (see Figure 6). Save these plugs. They may be reinstalled at Step 13.
2. Using a hammer, knock on the outside of the frame rail in the area indicated in Figure 4 to loosen any rust on the inside of the frame.
3. Using a blow gun, through the side frame hole, blow any rust debris to the front end and to the rear end of the frame away from the area indicated in Figure 4.
4. Using a wire brush and scraper, remove any loose debris (i.e., packed snow or ice, dust, gravel, tar, dirt, mud, rust and any undercoating), from the outside frame and rear lower trailing link front mounting bracket areas on both driver and passenger sides.
5. Using a dry rag remove any remaining dust or debris. If the application area is wet, use a blow gun to remove any water.
6. Locate the long spray nozzle for Noxudol 700 and place a mark (tape or pen) 300 mm (12 inches) and 200 mm (7 inches) from the spray end of the nozzle. This mark indicates how far you will insert the long nozzle for some of the following steps. See Figure 7. Install the long spray nozzle onto a can of Noxudol 700.



Figure 6 – Frame Hole Plug



Figure 7 – Noxudol with Long and Short Spray Nozzles

NOTE: During these next steps place a drain pan below the frame's drain hole. Excess Noxudol 700 will run out of the frame's drain hole. This should be expected and considered normal.

CAUTION: Noxudol propellant is highly flammable. Keep away from sources of ignition ~ no smoking. Keep at temperature not exceeding +50°C.

IMPORTANT: Wear hand and eye protection to avoid direct contact. Application should be performed in an area with adequate ventilation. See manufacturer's information for details.

7. Insert the long spray nozzle with Noxudol 700 into the drain hole located on the bottom of frame up to the 300 mm (12 inches) mark. Then spray Noxudol 700 while drawing out the nozzle. Spray two times. See Figures 8 and 9.



Figure 8 - Drain Hole



Figure 9 - Nozzle Path (300 mm)

8. Insert the long spray nozzle with Noxudol 700 into the side frame hole toward the front of the vehicle up to the 300 mm (12 inches) mark. Then spray Noxudol 700 while drawing out the nozzle. Spray four times. See Figure 10.
9. Insert long spray nozzle with Noxudol 700 into the side frame hole toward the rear of the vehicle up to the 200 mm (7 inches) mark. Then spray Noxudol 700 while drawing out the nozzle. Spray four times. See Figure 11.



Figure 10 – Frame Hole Toward Front (300 mm)



Figure 11 – Frame Hole Toward Rear (300 mm)

10. Insert long spray nozzle with Noxudol 700 through the side frame hole up and down. See Figures 12 and 13. Then spray Noxudol 700 with drawing out the nozzle. Spray two times in each direction.
11. Switch from the long spray nozzle to the short spray valve shown in Figure 7 and spray one coat of Noxudol 700 onto the outside of both driver and passenger side in the area indicated in Figure 4. Be careful not to overspray onto the exhaust system or body painted areas.



Figure 12 - Frame Hole Down



Figure 13 - Frame Hole Up

12. Complete Condition One: Apply Noxudol 300, Steps 1-3.
13. Install the side frame hole plug. If the plug's locking tabs were damaged during removal or are missing, replace it (P/N 8-97175-885-0).
14. Apply the campaign label (see "Applying the Campaign Label" in this bulletin).

CONDITION THREE: REINFORCEMENT BRACKET TYPE "A" INSTALLATION FOR AXIOMS AND RODEOS (EXCLUDING RODEO SPORT)

1. Remove the following components as per the service manual (see Figure 15):
 - a. Rear trailing link from mount mounting nut from driver and passenger sides.
 - b. Remove running boards or side steps (if equipped).
2. Remove lower half of body mount #4 from both driver and passenger side. See Figures 15 and 16.
3. Using a ratcheting strap, lash up the rear axle. Start by attaching one end of the strap to the upper link mount. Then route the strap around the rear axle, taking care not to cover any brake piping, and continue forward under the vehicle, attaching the other end of the strap to the transmission mount cross member. Apply enough forward tension on the rear axle to allow the lower link mounting bolt to be moved by hand (see Figure 14).



4. Using a hammer, knock on the outside of the frame rail to loosen any rust on the inside of the frame.
5. Using a wire brush and scraper remove any loose coating material, welding splatter and rust from the outside frame and rear lower trailing link front mounting bracket area on both driver and passenger sides.
6. Temporarily install both reinforcement brackets using the original lower link mounting nuts, "C" clamps and new studs and nuts. See Figures 15 and 16.

CAUTION: When placing the "C" clamp on the passenger side; be sure not to contact the brake lines on the inside of the frame rail.

NOTE: It will be necessary to remove the fuel tank protector mounting bolt on the driver side for 2003 and 2004 model year vehicles. Save the bolt for reuse. It will be required for final installation of the reinforcement bracket on the driver side.

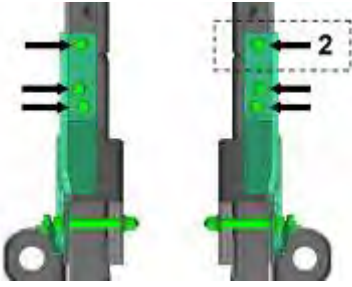



Figure 15 - Driver Side Temporary Installation

1. #4 Body Mount Lower Half Removed
2. Weld Nut Already in Frame
3. Stud and Nut

7. Using the 1/4" drill bit guide or equivalent, drill 1/4" pilot holes for 6 new Pop-nut locations (See Note and Figures 16, 17 and 18 for reference).

NOTE: There is a nut welded into the driver side frame at location 2 in Figure 16. This location is for the fuel tank protector. **DO NOT DRILL THIS LOCATION.**

		
<p>Figure 16 - Drilling Locations [2] This Location has a Welded Nut for the Fuel Tank Protector – DO NOT DRILL</p>	<p>Figure 17 - Drill Guide and Bracket</p>	<p>Figure 18 - 1/4" Holes</p>

8. Remove both reinforcement brackets. Save the body mount stud and nut for final installation. Discard the original rear trailing link front mount mounting nut. A new one is provided in the kit for installation.

9. Drill final holes for Pop-nuts using a 3/64" drill bit. DO NOT DRILL THIS LOCATION IF A WELDED NUT IS PRESENT.

10. Using a blow gun through the side frame hole, blow any rust debris away from this area up and down the inside frame rail.

11. Install Pop-nuts (see tool manual for additional details).

- a. Before installing the Pop-nuts, be sure the pressure regulator is adjusted between 72.5 and 87 psi (0.5-0.6 MPa / 5-6 bar) and using the provided test pieces, test install at least one Pop-nut in the test plate to be sure the nut is seating properly.

NOTE: Air pressure regulator adjustment is critical. Excessive air pressure will result in tool damage while low pressure may result in incorrect Pop-nut installation.

- b. When Installing Pop-nuts on the vehicle, be sure they are completely seated against the frame before pulling the trigger. See Figure 21.

- c. After pulling trigger, continue to hold it down until the mandrel reverses direction. Once reversed pull back slightly and the mandrel will unthread from the Pop-nut. See Pop-nut Installer manual for details.

	
<p>Figure 19 - Pop-nut Test Plate and Extra Pop-nuts (provided in kit)</p>	<p>Figure 20 - Pop-nut on Test Plate</p>



Figure 21 - Pop-nut Installer Ready for Use

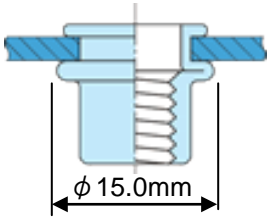

Figure 22 - Passenger Side Pop-nuts Installed

12. Using the $\frac{3}{4}$ " round labels provided in the service kit, mask off the Pop-nuts. Use tape to mask off other related bracket mounting locations highlighted in Figure 23. This is required to inhibit Noxudol chemicals from coating the bracket mounting surfaces.

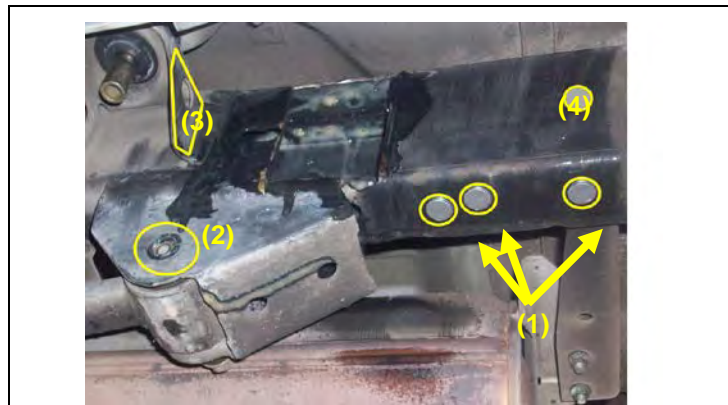

Figure 23 - Masking Locations for Bracket Type "A"

1. $\frac{3}{4}$ " Round Labels
2. Mask Over Mounting Bolt/Nut Location
3. Mask Both Sides at #4 Body Mount for Stud and Nut Location
4. Frame Hole Plug

13. Follow Steps 6 through 12 in the section of this bulletin entitled "Condition Two: Apply Noxudol 700 and Noxudol 300."

14. Remove all masking.

15. Remove the passenger side lower link mounting bolt.

NOTE: In 2003MY through 2004MY vehicles the mounting bolt cannot be removed due to interference with the exhaust silencer. For these models, use a reciprocating saw to cut off the lower link mounting bolt head. Push the remaining section of bolt back out through the mount.

16. Install the passenger side reinforcement bracket using the new hardware provided in the kit.

17. Torque the bolts in the sequence and to the specifications shown in Figure 24.

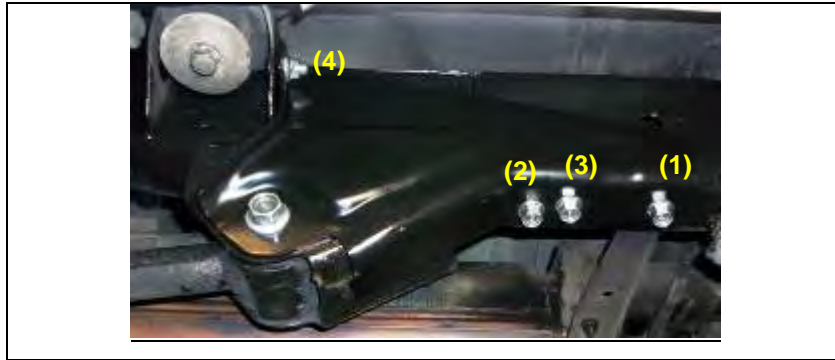

Figure 24
 1.-3. Bracket Bolts Torque to 25-30 Nm (18-22 lb ft)
 4. Body Mount Stud and Nut Torque to 50-55 Nm (37-41 lb ft)

18. Using a reciprocating saw, remove the driver side rear trailing link front mount mounting bolt. Push the bolt back toward the fuel tank as far as possible. Insert the saw between the head of the mounting bolt and the mounting bracket. Cut away the bolt head. Push the remaining section of bolt back out through the mount.
19. Install the driver side reinforcement bracket using the new hardware provided in the bracket kit. The required parts will vary depending on vehicle model year and frame design. Use Figure 25 for reference to correctly install the driver side bracket.

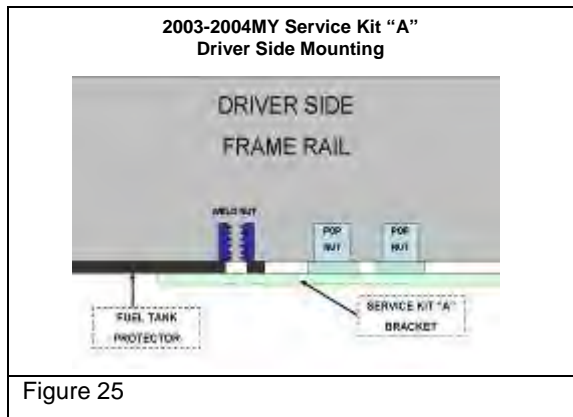

Figure 25

20. Torque the bolts in the sequence and to the specifications shown in Figure 26.
21. Remove the ratcheting straps.

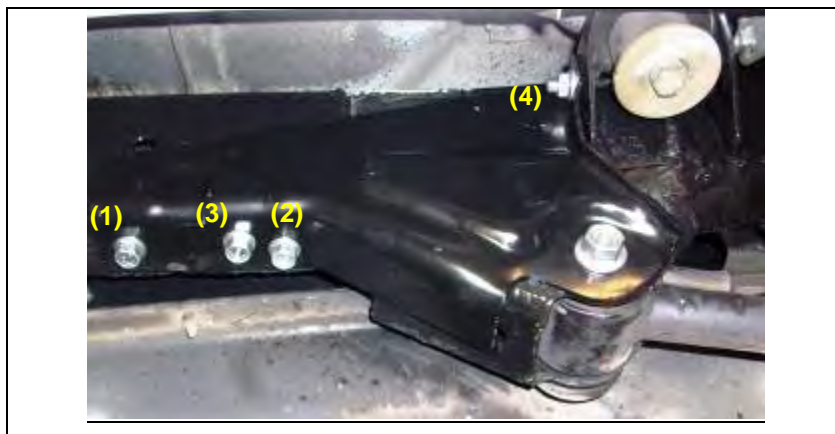

Figure 26
 1.-3. Bracket Bolts; Torque to 25-30 Nm (18-22 lb ft)
 4. Body Mount Stud and Nut; Torque to 50-55 Nm (37-41 lb ft)

22. Lower the vehicle to the ground and torque both rear trailing link front mount mounting bolts to specification. Torque to 165 to 180 Nm (122-133 lb ft).
23. Apply the campaign label (see "Applying the Campaign Label" in this bulletin).

CONDITION THREE: REINFORCEMENT BRACKET TYPE “C” INSTALLATION (RODEO SPORT ONLY)

Reinforcement bracket type “C” must be installed on both the driver and the passenger side of the vehicle; it is not intended for installation on one side only.

1. Remove the following components as per the service manual (See Figure 28):
 - a. Rear trailing link front mount mounting nut from driver and passenger sides.
 - b. Remove running boards or side steps (if equipped).
2. Using a ratcheting strap, lash up the rear axle. Start by attaching one end of the strap to the upper link mount. Then route the strap around the rear axle, taking care not to cover any brake piping, and continue forward under the vehicle, attaching the other end of the strap to the transmission mount cross member. Apply enough forward tension on the rear axle to allow the lower link mounting bolt to be moved by hand. See Figure 27.



Figure 27 – Ratchet Straps Installed

3. Using a hammer, knock on the outside of the frame rail to loosen any rust on the inside of the frame.
4. Using a wire brush and scraper remove any loose coating material, welding splatter and rust from the outside frame and rear lower trailing link front mounting bracket area on both driver and passenger sides.
5. Temporarily install both type “C” reinforcement brackets using the original lower link mounting nuts, “C” clamps, new body mount studs and nuts. See Figure 28.

CAUTION: When placing the “C” clamp on the passenger side be sure not to contact the brake lines on the inside of the frame rail.

NOTE: It will be necessary to remove the fuel tank protector mounting bolt(s) on the driver side for 2003 model year vehicles. Save the bolt(s) for reuse. It will be required for final installation of the reinforcement bracket on the driver side.

NOTE: Technicians may elongate the lower link mounting bolt hole in the type “C” bracket should an unforeseen change in tolerances cause the bracket not to properly align at this location. See Figure 44 for reference.

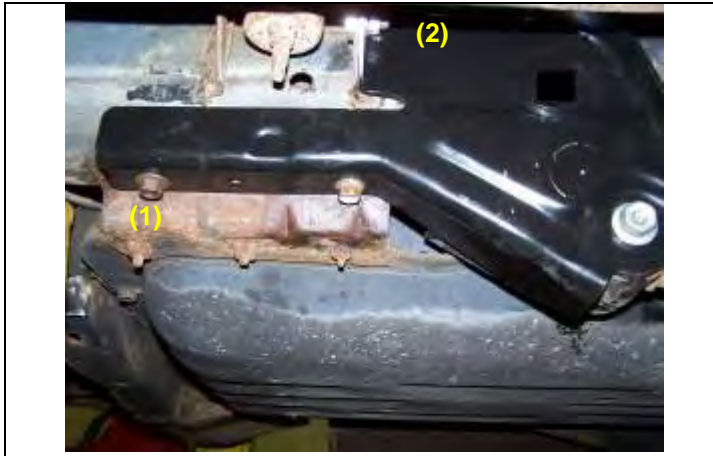

Figure 28 – Driver Side Temporary Installation

1. Weld Nuts Already in Frame
2. Stud and Nut

6. Using the 1/4" drill bit guide or equivalent, drill 1/4" pilot holes for six new Pop-nut locations (see Note and Figures 29, 30 and 31 for reference).

NOTE: There is a nut welded into the driver side frame at location 2 in Figure 29. This location is for the fuel tank protector. DO NOT DRILL THIS LOCATION.

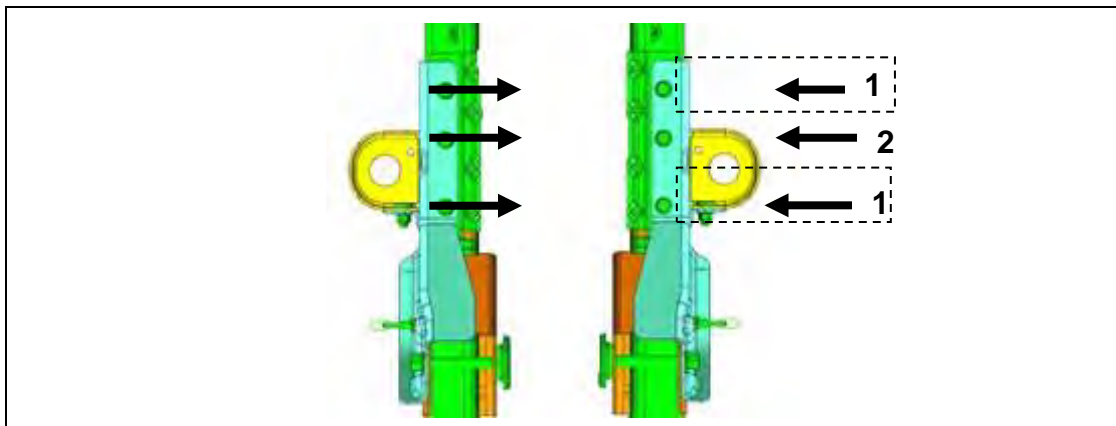

Figure 29 – Drilling Locations

1. These locations may have weld nuts – DO NOT DRILL
2. This location is not used for 2003MY



Figure 30 – Drill Guide and Bracket



Figure 31 – 1/4" Holes



7. Remove both reinforcement brackets. Save the body mount studs and nuts for final installation. Discard the original rear trailing link front mount mounting nuts. New ones are provided in the kit for installation.
8. Drill final holes for Pop-nuts using a 3/32" drill bit. DO NOT DRILL THIS LOCATION WHERE A WELDED NUT IS PRESENT.
9. Using a blow gun through the side frame hole, blow any rust debris away from this area up and down the inside frame rail.

10. Install Pop-nuts (see tool manual for additional details).

- a. Before installing the Pop-nuts (P/N 8-98174-539-0), be sure the pressure regulator is adjusted between 72.5 and 87 psi (0.5-0.6MPa / 5-6bar) and using the provided test pieces, test install 1-3 Pop-nuts onto the test plate to be sure they are seating properly. See Figure 58.

NOTE: Air pressure regulator adjustment is critical. Excessive air pressure will result in tool damage while low pressure may result in incorrect Pop-nut installation.

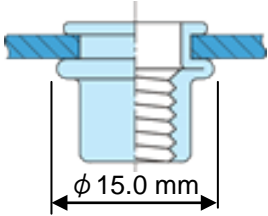
- b. When Installing Pop-nuts on the vehicle, be sure they are completely seated against the frame before pulling the trigger. See Figure 34.
- c. After pulling trigger, continue to hold it down until the mandrel reverses direction. Once reversed pull back slightly and the mandrel will unthread from the Pop-nut. See Pop-nut installer manual for details.

	
Figure 32 – Pop-nut Test Plate and Extra Pop-nuts (provided in kit)	Figure 33 – Pop-nut on Test Plate
	
Figure 34 – Pop-nut Installer Ready for Use	Figure 35 – Passenger Side Pop-nuts Installed

- 11. Using the 3/4" round labels provided in the service kit, mask off the Pop-nuts. Use tape to mask off other related bracket mounting locations highlighted in Figure 36. This is required to inhibit Noxudol chemicals from coating the bracket mounting surfaces.

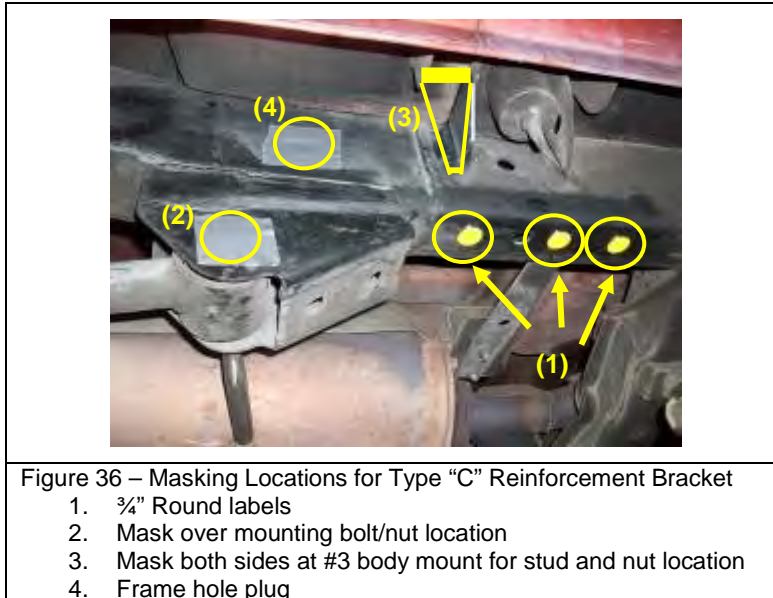

12. Follow Steps 6 through 12 in the section of this bulletin entitled “Condition Two: Apply Noxudol 700 and Noxudol 300.”
13. Remove all masking.
14. Remove the passenger side lower link mounting bolt.
15. Install special “T” bolt onto Type “C” bracket. See Figures 38-44.
16. Install the passenger side reinforcement bracket using the new hardware provided in the kit.
 - a. First insert the special “T” bolt through the frame hole and then rotate 90deg. Then pull on the special “T” bolt to ensure the shoulder is centered and fully seated in the frame hole, then hand tighten the nut. See Figure 41. Install remaining hardware and hand tighten.
17. Torque the bolts in sequence and to the specifications shown in Figure 37.
 - a. When torqueing the special “T” bolt, ensure bolt alignment is correct. See Figures 38-44.

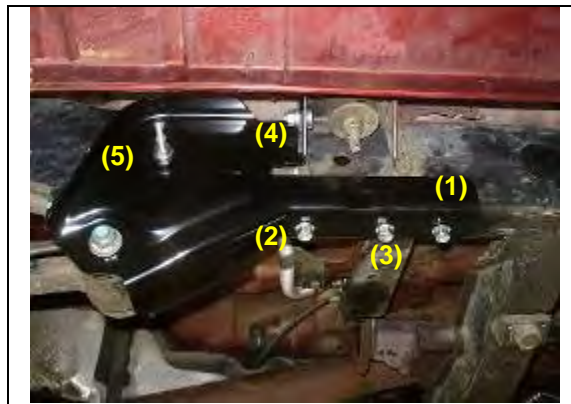

Figure 37
 1.-3. Torque to 25-30 Nm (18-22 lb ft)
 4.-5. Torque to 50-55 Nm (37-41 lb ft)

18. Using a reciprocating saw, remove the driver side rear trailing link front mount mounting bolt. Push the bolt back toward the fuel tank as far as possible. Insert the saw between the head of the mounting bolt and the mounting bracket. Cut away the bolt head. Push the remaining section of bolt back out through the mount.
19. Install the special “T” bolt onto Type “C” bracket. See Figures 38-44.

20. Install the driver side reinforcement bracket using the new hardware provided in the bracket kit. Use Figures 38-44 for reference to correctly install the driver side bracket.

- a. First insert the special "T" bolt through the frame hole and then rotate 90deg. Then pull on the special "T" bolt to ensure the shoulder is centered and fully seated in the frame hole, then hand tighten the nut. See Figure 41. Install remaining hardware and hand tighten.

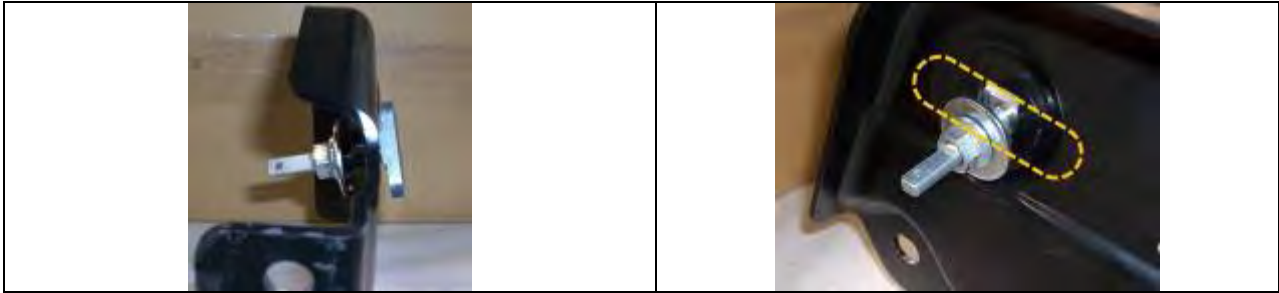

Figure 38 – Type "C" Reinforcement Bracket with Special "T" Bolt, Nut and Washer Assembled

Figure 39

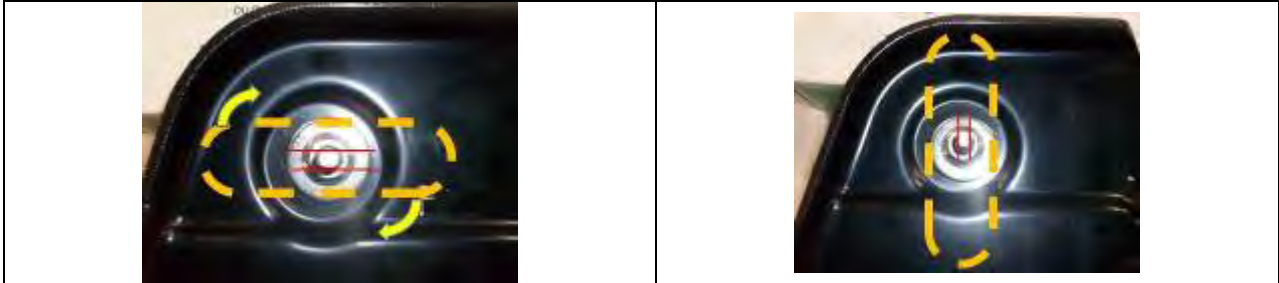

Figure 40

Figure 41

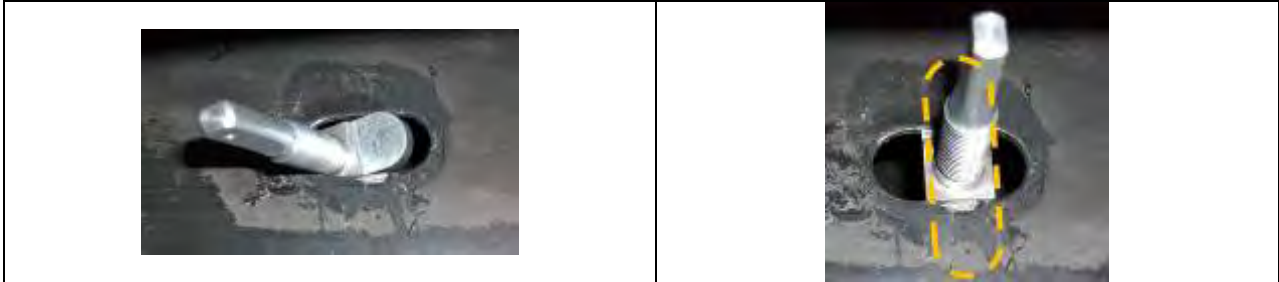

Figure 42

Figure 43

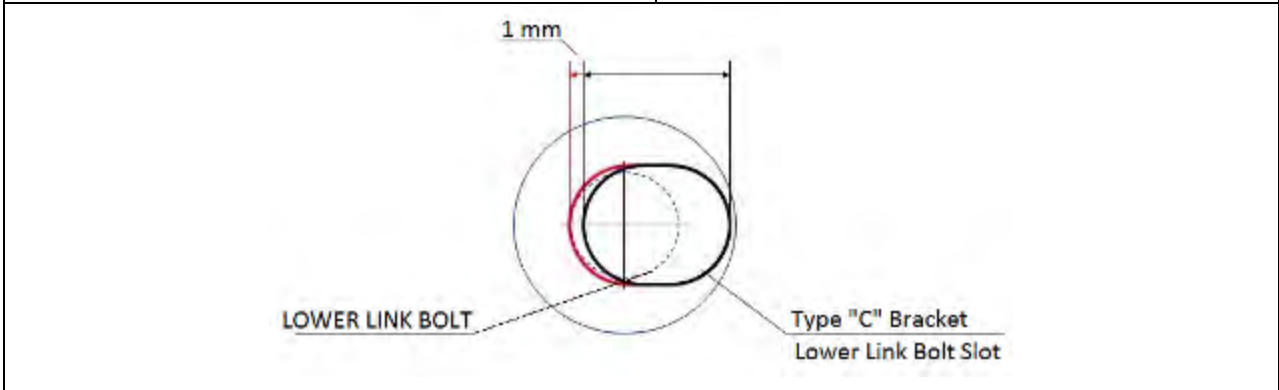
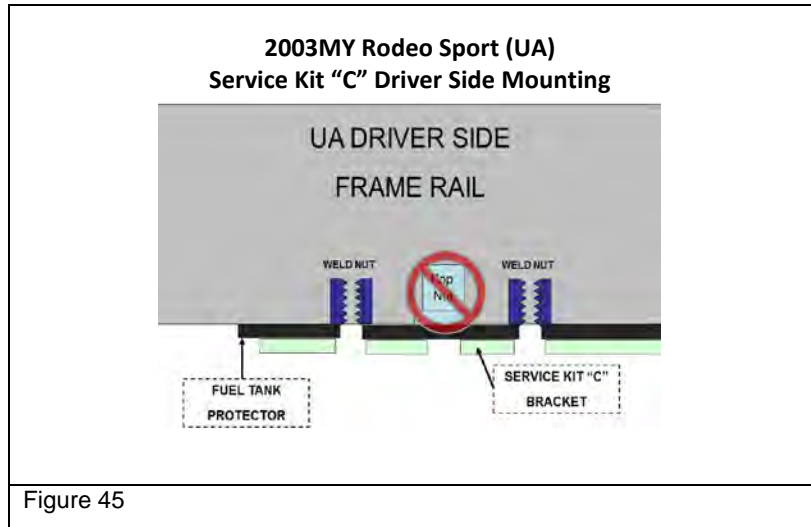
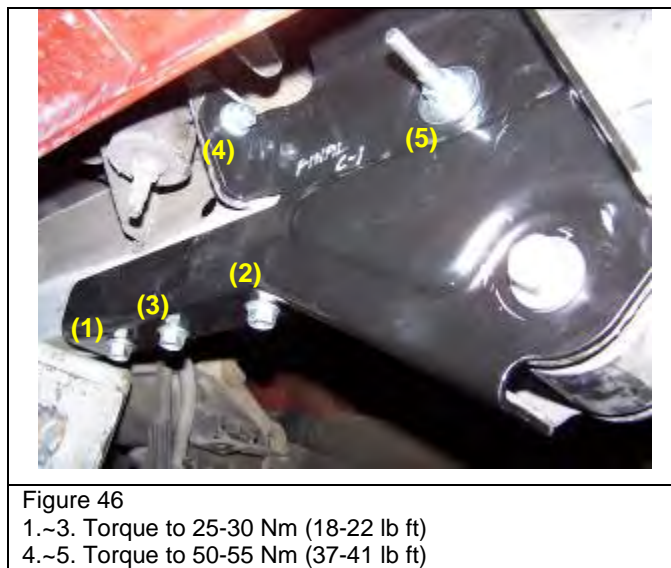

Figure 44



21. Torque bolts in the sequence and to the specifications shown in Figure 46.
22. Remove the ratcheting straps.



23. Lower the vehicle to the ground and torque both rear trailing link front mount mounting bolts to specification. Torque to 165 to 180 Nm (122-133 lb ft).
24. Apply the campaign label (see "Applying the Campaign Label" in this bulletin).

CONDITION FOUR: REINFORCEMENT BRACKET TYPE “B” INSTALLATION FOR AXIOMS AND RODEOS (EXCLUDING RODEO SPORT)

Note: Prior to this repair procedure, it is strongly recommended that the technician thoroughly inspect the subject vehicle, including the entire underside and note any damage and/or modifications. If issues are noted that may affect the completion of this repair, please review immediately with your Service Manager or contact a National Operations Manager at 1-800-533-0244 (Option 2) prior to attempting the repair.

Caution: This repair procedure includes removing and reinstalling the fuel tank, fuel lines, and vent lines. Gasoline and gasoline fumes are highly volatile. Proper care should be taken during removal, storage, and reinstallation of these components. Please ensure that this repair is completed in a well vented area, away from any ignition sources.

Reinforcement bracket type “B” must be installed on both the driver and the passenger side of the vehicle; it is not intended for installation on one side only.



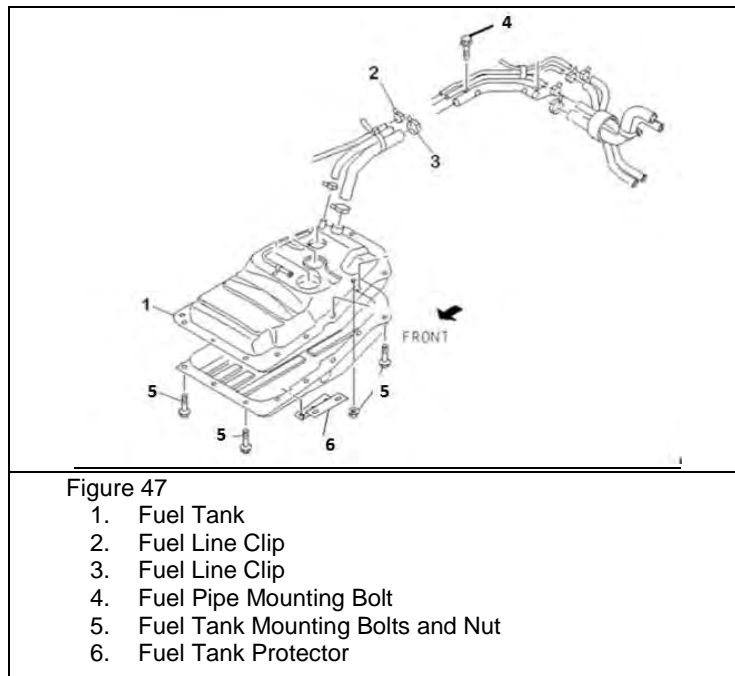

This procedure will outline all necessary steps to cut away the original rear trailing link front mounts and install replacement brackets. Follow the below steps carefully paying close attention to all notes and important statements. **Not following this procedure carefully could result in permanent frame damage making the vehicle unrepairable.**

1. Remove the fuel tank assembly per the service manual. New clamps are provided in kit.
 - a. Disconnect fuel line at fuel filter supply and return hoses.
 - b. Disconnect fuel tank at locations 2 and 3 shown in Figure 47.

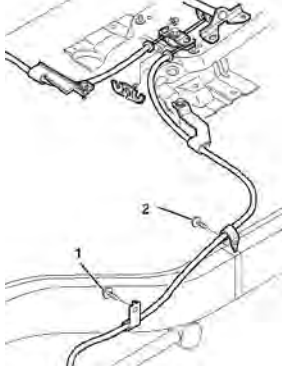
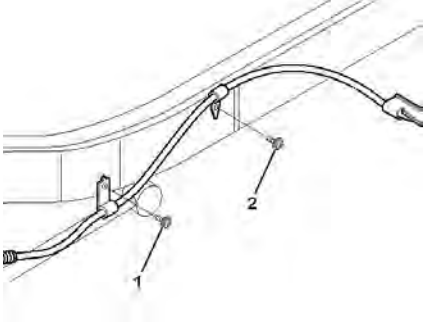

2. Inspect the interior frame rail at the mounting points for the bracket. If perforation is evident at these mounting points, please review immediately with your service manager or contact a National Operations Manager at 1-800-533-0244 (Option 2) prior to attempting the repair.
3. Remove the following components per the service manual.
 - a. Rear bumper assembly (UE only).
 - b. Rear bumper fascia and fascia support bracket (UP only).
 - i. 2 Nuts front flange
 - ii. 2 Nuts rear flange
 - iii. 4 Nuts rubber mount
 - c. Exhaust silencer. New gaskets provided in kit.
 - d. Linear EGR valve. New gasket provided in kit.
NOTE: EGR valve removal is not required for vehicles with 3.5 DI engine.
 - e. Front grill (UE only).

- f. Running boards or side steps (UE only if equipped).
 - g. Rocker protector cover (UP only).
 - h. Undermount spare tire (if equipped).
4. Support underneath of fuel tank protector with a lifter.
5. Remove/disconnect the following components per the service manual:
- a. Parking brake cable passenger side mounting bolts (2 points). See Figure 48.
 - b. Parking brake cable driver side mounting bolts (2 points). See Figure 49.
 - c. Wiring harness clips from frame driver side (6 points). See Figure 50.
 - d. Brake piping clips passenger side clips (4 clips). See Figure 51.
 - e. ABS speed sensor harness driver and passenger side (4 points). See Figure 52
 - f. Brake pipe retaining clip driver and passenger side (2 points). See Figure 52.
 - g. Canister pipe (3 points). See Figure 53.
 - h. Active suspension connector front right and left (if equipped).
 - i. Fuel tank protector by removing the fixing bolts.

		
<p>Figure 48 - Parking Brake Cable Passenger Side</p>	<p>Figure 49 - Parking Brake Cable Driver Side</p>	<p>Figure 50 - Wire Harness</p>
		
<p>Figure 51 - Brake Piping</p>	<p>Figure 52 - ABS Harness and Pipe</p>	<p>Figure 53 - Canister Pipe</p>

6. Remove body mount mounting nuts and bolt (mounts #1, #2, #4 and #5 use nuts / mount #3 uses a bolt) for body mounts #1 through #5. See Figure 54.

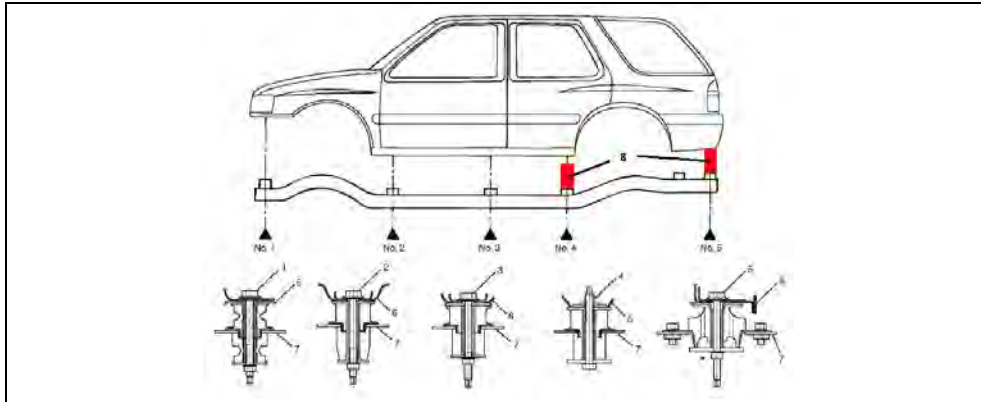

Figure 54
 1-5. Body Mounts
 6. Body Side Mounting Bracket
 7. Frame Side Mounting Bracket
 8. Wooden Block Support Locations (body mount #5 and #4 right and left sides)

7. Using ratcheting straps, lash up the rear axle at the driver and passenger side. Start by placing one end of the strap above the axle at the driver side inside frame rail, route the other end of the strap down, underneath, the rear axle and then back up above the outside of the driver side frame rail. Connect both ends of the strap together and remove any slack. Repeat this process for the passenger side.
8. Lower the vehicle to the ground. Raise the rear of the body off of the frame and support.
9. Remove the 2 mounting bolts from the top of body mount number #5 (Right and Left sides) and remove the body mount.
10. Remove the top of body mount number #4.

CAUTION: Failure to install the wooden blocks as directed below can create a dangerous situation in which the rear section of the frame rail may break off, collapse to the ground and cause serious personal injury to the technician during the repair as well as permanent frame damage, making the vehicle unreparable.

11. Using wooden blocks, support the body off of the frame. See Figures 35 and 36.
 - a. Body mount #5 should be 10.25 inches (260 mm) above the frame and body mount #4 should be at least 7.0 inches (175 mm).



Figure 55 - Wood Block Installed at #5 Body Mount



Figure 56 - Wood Block Installed at #4 Body Mount

NOTE: When raising the vehicle, be sure that the body does NOT shift forward.

12. Remove the rear lower link front mounting bolts, on driver and passenger side. Discard mounting bolts and nuts. New hardware is provided in the bracket kit.
13. Raise the vehicle into the air.
14. Remove the rear trailing link front mount. See Figure 57 for reference.
 - a. Using a cutting wheel cut just below or through the weld to remove the bracket.
 - b. Use a disk grinder to remove any excess material and smooth out the frame.

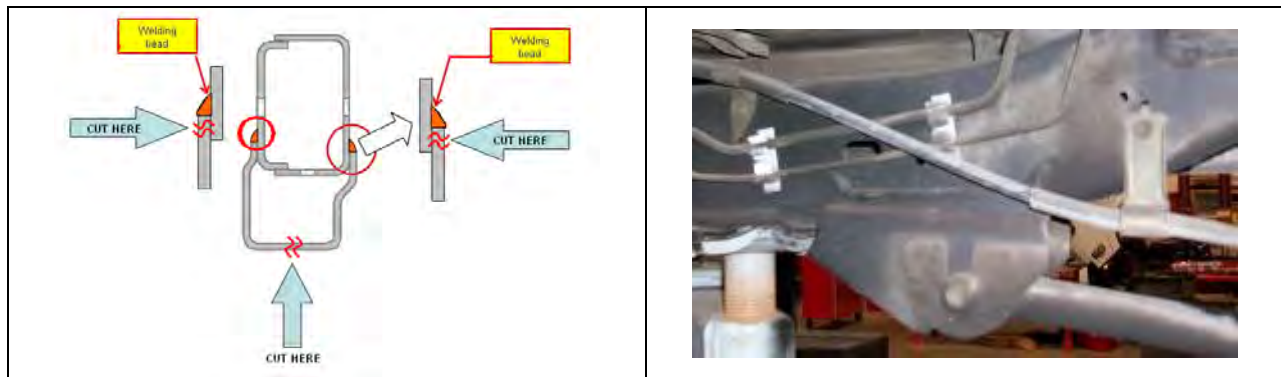

Figure 57 - Rear Trailing Link Removal

Figure 58 - Passenger Side Bracket Before Removal

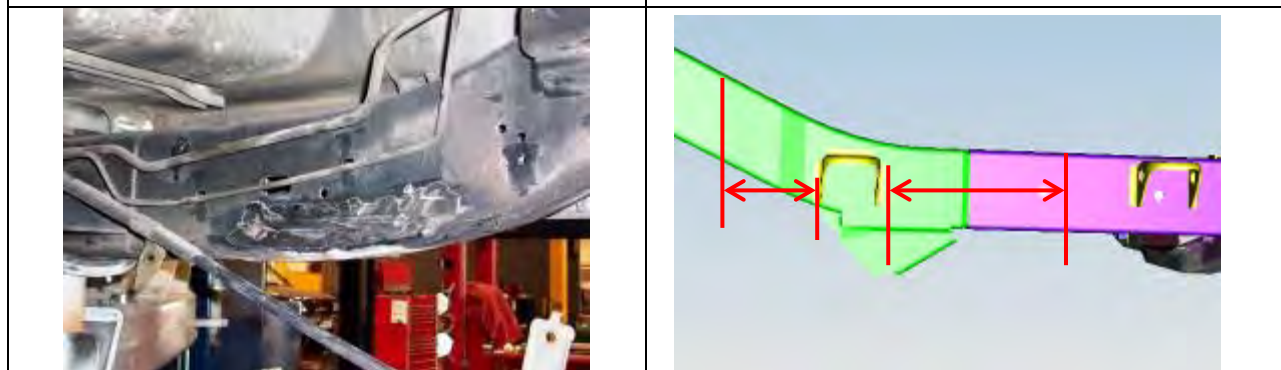

Figure 59 - Frame After Bracket Removal

Figure 60 - Frame Rail Cleaning Area

15. Remove the frame hole plug from the driver and passenger side frame rails as shown in Figure 6. Discard the plug.
16. Using a hammer, knock on the outside of the frame rail to loosen any rust on the inside of the frame.
17. Using a wire brush and scraper remove any loose coating material and rust from the entire outside frame rail. Clean the area 10 inches forward and rearward the bracket location.
18. Using "C" clamps and the provided stud and nut (P/N 8-98174-543-0 and 8-97245-646-0), temporarily install both right and left brackets as shown in Figure 61.
 - a. Start by securing the bracket to the frame using the stud and nut at the upper link bracket.
 - b. Push the bracket up firmly against the frame and clamp into place with the "C" clamps. Be sure the clamps compress the bracket against the frame so there is not possibility of movement while marking the frame.

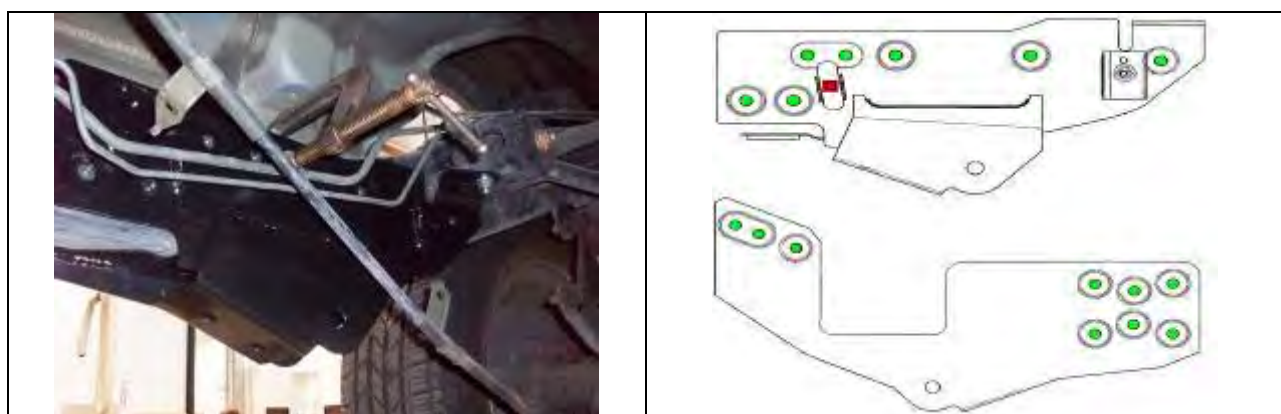

Figure 61 - Type "B" Bracket (temporary installation)

Figure 62 - 16 Green Dots for Pop-nut Locations (red square is required for clearance)

19. Using the 1/4" drill bit guide or equivalent, drill 1/4" pilot holes for each bracket mounting point into the frame rail, 16 holes for each bracket. See Figure 62.

IMPORTANT: Be sure the bracket does not move during the procedure.

20. Using a 1/4" drill bit, drill a hole in the frame through the passenger side reinforcement bracket brake clip mounting hole. See Figure 63.

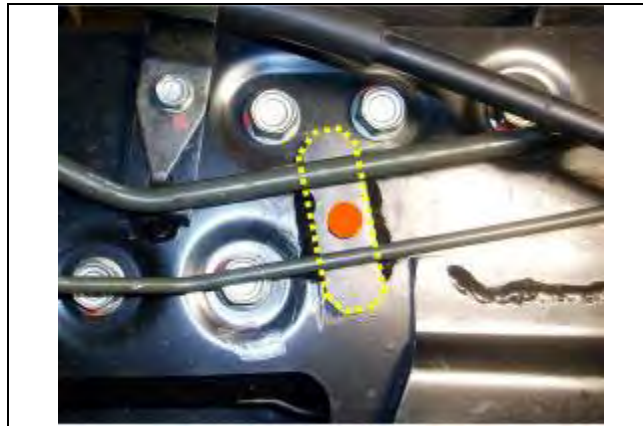

Figure 63

21. Remove both reinforcement brackets.
22. Locate the 1/4" hole drilled in Step 19. Use the 33/64" drill bit and final drill this location. Mark this location with tape or chalk. This hole is required to provide clearance for the passenger side brake pipe clip. See Figure 63.

IMPORTANT: Do not install a Pop-nut in this location. This hole is required clearance for the passenger side brake pipe clip.

23. Use the 33/64" drill to final drill all of the mounting holes.
24. Test fit a Pop-nut into each hole to be sure drilling is complete.

IMPORTANT: Do not attempt to round out (open the hole by pivoting the drill bit) the hole if the Pop-nut does not fit. Doing so will create an uneven seating surface for the Pop-nut. If the nut does not fit after drilling, your drill is worn out and needs to be sharpened or replaced.

25. Using a blow gun through the frame hole, blow any rust debris away from this area up and down the inside frame rail.

26. Install Pop-nuts (see tool manual for additional details).
 - a. Before installing the Pop-nuts (P/N 8-98174-539-0), be sure the pressure regulator is adjusted between 72.5 and 87 psi (0.5-0.6MPa / 5-6bar) and, using the provided test pieces, test install one to three Pop-nuts into the test plate to be sure the Pop-nuts are seating properly. See Figures 64 and 65.

NOTE: Air pressure regulator adjustment is critical. Excessive air pressure will result in tool damage while low pressure may result in incorrect Pop-nut installation.

- b. When Installing Pop-nuts, be sure the Pop-nuts are completely seated against the frame before pulling the trigger. See Figure 34.
- c. After pulling trigger, continue to hold it down until the mandrel reverses direction. Once reversed pull back slightly and the mandrel will unthread from the Pop-nut. See the Pop-nut installer manual for details.

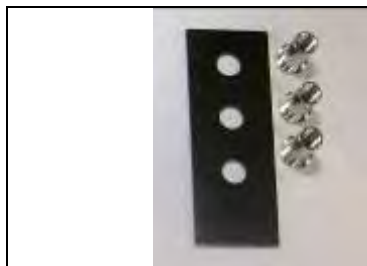

Figure 64 - Pop-nut Test Plate and Extra Pop-nuts (provided in kit)

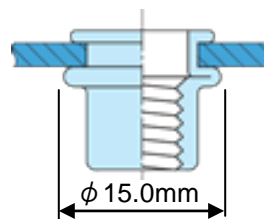





Figure 65 - Pop-nut on Test Plate

27. Temporarily install both right and left brackets again. Confirm all bolts can be properly started in each Pop-nut.
28. Remove both reinforcement brackets.
29. Using 3/4" round labels, mask off the Pop-nuts. Using tape, mask off other related bracket mounting locations (see Figures 66 and 67). This is required to inhibit Noxudol chemicals from coating the bracket mounting surfaces.
30. Follow Steps 6 through 12 in the section of this bulletin entitled "Condition Two: Apply Noxudol 700 and Noxudol 300."
31. Change to the spray valve and spray one light coat of Noxudol 700 onto inner and outer frame rail of both driver and passenger side. Wipe away any drips from the bottom of the frame rail. See Figure 68.
32. Change to the spray valve and spray one coat of Noxudol 300 one onto inner and outer frame rail of both driver and passenger side. See Figure 69.
33. Remove tape and labels from the masked areas called out in Step 29.

	
<p>Figure 66 - Upper Trailing Link Masking Point</p>	<p>Figure 67 - Pop-nuts Masked with 3/4' Round Label</p>
	
<p>Figure 68 - Pop-nuts Masked and Sprayed with Noxudol 700</p>	<p>Figure 69 - Noxudol Spray Completed and Pop-nuts</p>

34. Install both reinforcement brackets using the stud and nut from Step 14 together with 32 new mounting bolts (P/N 8-98174-544-0) provided in the bracket kit.
35. Torque bolts according to the sequence and specifications shown in Figure 70.

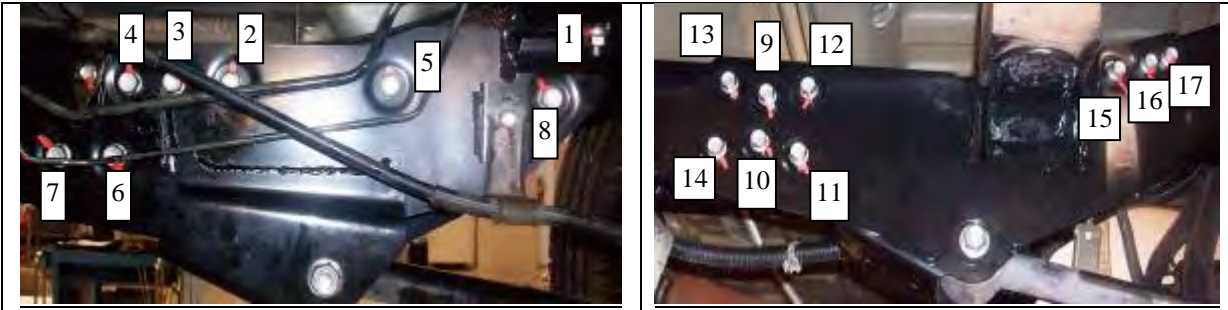

Figure 70

1. Body Mount Stud and Nut; Torque to 50-55 Nm (37-40 lb ft)
 2.-17. Bracket Bolts; Torque to 25-30 Nm (18-22 lb ft)

36. Install both rear trailing links (new bolt (P/N 0-29261-400-0 and nut P/N 8-98181-530-0 provided in the kit) and secure but do not apply the final torque. Final torque must be applied with the vehicle resting on the ground.
37. Remove both ratcheting straps installed in Step 7.
38. Lower the vehicle to the ground.
39. Raise the body up enough to remove the wooden blocks supports.
40. Install #5 body mounts and torque bolts to specification. Torque: 50 Nm (37 lb ft)
41. Spray Noxudol 300 around the #4 body mount location.
42. Lower the body down onto the frame and torque body mounts to specification. Torque: 50 Nm (37 lb ft)
43. Torque the both rear trailing link front mount mounting bolts to specification. Torque to 165 to 180 Nm (122-133 lb ft).
44. Raise the vehicle into the air and secure the following components:
 - a. Parking brake cable passenger side (2 points).
 - i. New Bolt (2) P/N 0-28050-612-0; Torque: 6.5 to 8.5 Nm (57 to 75 lb in)
 - b. Parking brake cable driver side (2 points).
 - i. New Bolt (2) P/N 0-28050-612-0; Torque: 6.5 to 8.5 Nm (57 to 75 lb in)
 - c. Wiring harness from frame driver side (6 points).
 - i. 3 points on included on new bracket
 - ii. 3 points new frame clips P/N 9-97209-720-0
 - d. Brake piping passenger side clips (4 clips).
 - i. 3 clips frame rail
 1. V6 P/N 8-97125-111-1
 2. 4cyl P/N 8-97236-077-0
 - ii. 1 clip for new bracket position P/N 9-98153-939-1
 - e. ABS harness and piping right front fender well.
 - f. Canister pipe (3 points)
 - g. Brake pipe retaining clip driver and passenger side. See Figure 51 (2 points)
 - h. Active suspension connector front right and left (if equipped).
45. Re-Install the fuel tank assembly per service manual:
 - a. Install fuel tank protector and tighten the fixing bolts and nut in location 6. Torque: 20 Nm (15 lb ft)
 - b. Install fuel supply line at fuel filter using new clamp (P/N 8-97148-892-1)
 - c. Install fuel return line at fuel filter using new clamp (P/N 8-94238-572-0)
 - d. Install fuel tank. Install new parts at locations 2, 3 and 5 as shown in Figure 71.

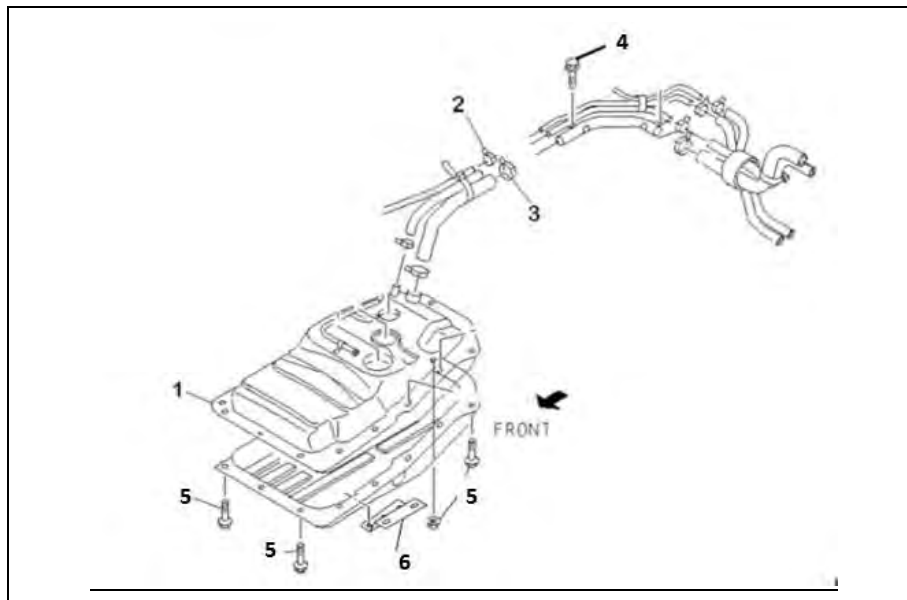

Figure 71

1. Fuel Tank
2. Fuel Line Clip
'01-'04MY 8094242-034-0
3. Fuel Line Clip
'01-'04MY 8-97237-146-0
4. Fuel Pipe Mounting Bolts
5. Fuel Tank Mounting Bolt & Nut
Nut 8-97142-595-0
Bolt 8-97174-300-1
6. Fuel Tank Protector Bolts and Washers
Bolts: 8-98174-544-0
Washers: 0-9161-4810-0

46. Install the following components per the service manual.

- a. Rear Bumper Assembly (UE only)
- b. Rear Bumper Fascia and Fascia support bracket (UP only)
 - i. 2 nuts front flange
 - ii. 2 nuts rear flange
 - iii. 4 nuts rubber mount
- c. Exhaust silencer. Replace gaskets (P/N 8-97148-757-1).
- d. Linear EGR valve. Replace gasket (for V6 (P/N 8-97104-317-2), for 4cyl. (8-90467-547-0)).
NOTE: EGR valve replacement is not required for vehicles with 3.5 DI engine.
- e. Front Grill (UE only)
- f. Running Boards or Side Steps (UE only, if equipped)
- g. Rocker Protector Cover (UP only)
- h. Undermount spare tire (if equipped)

47. Apply the campaign label (see "Applying the Campaign Label" in this bulletin).

CONDITION FOUR: REINFORCEMENT BRACKET TYPE “D” INSTALLATION (RODEO SPORT ONLY)

Note: Prior to this repair procedure, it is strongly recommended that the technician thoroughly inspect the subject vehicle, including the entire underside and note any damage and/or modifications. If issues are noted that may affect the completion of this repair, please review immediately with your Service Manager or contact a National Operations Manager at 1-800-533-0244 (Option 2) prior to attempting the repair.

Caution: This repair procedure includes removing and reinstalling the fuel tank, fuel lines, and vent lines. Gasoline and gasoline fumes are highly volatile. Proper care should be taken during removal, storage, and reinstallation of these components. Please ensure that this repair is completed in a well vented area, away from any ignition sources.

Reinforcement bracket type “D” must be installed on both the driver and the passenger side of the vehicle; it is not intended for installation on one side only.

This procedure will outline all necessary steps to cut away the original rear trailing link front mounts and install replacement brackets. Follow the below steps carefully paying close attention to all notes and important statements. **Not following this procedure carefully could result in permanent frame damage therefore making the vehicle unrepairable.**

1. Remove the fuel tank assembly as per the service manual. New clamps are provided in kit.
 - a. Disconnect fuel line at fuel filter supply and return hoses.
 - b. Disconnect fuel tank at locations 2 and 3 as shown in Figure 72.

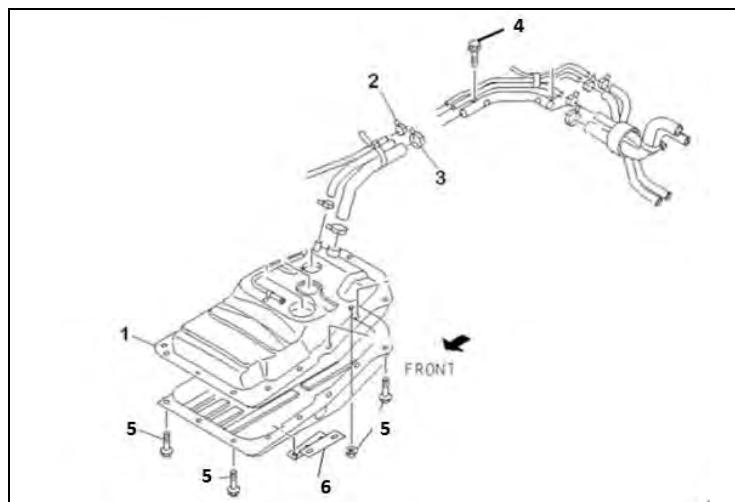

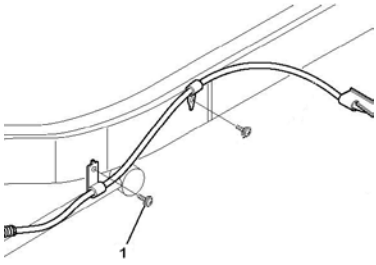







Figure 72

1. Fuel Tank
2. Fuel Line Clip
3. Fuel Line Clip
4. Fuel Pipe Mounting Bolt
5. Fuel Tank Mounting Bolts and Nut
6. Fuel Tank Protector

2. Inspect the interior frame rail at the mounting points for the bracket. If perforation is evident at these mounting points, please review immediately with your service manager or contact a National Operations Manager at 1-800-533-0244 (Option 2) prior to attempting the repair.
3. Remove the following components as per the service manual:
 - a. Rear bumper assembly.
 - b. Exhaust silencer – new gaskets provided in kit.
 - c. Linear EGR valve – new gasket provided in kit.
 - d. Front grill.
 - e. Running boards or side steps (if equipped).
 - f. Undermount spare tire (if equipped).
4. Support underneath of the fuel tank protector with a lifter.

5. Remove/disconnect the following components per the service manual:
 - a. Parking brake cable passenger side mounting bolts. See Figure 73 (1 point).
 - b. Parking brake cable driver side mounting bolts. See Figure 74 (1 point).
 - c. Wiring harness clips from frame driver side). See Figure 75 (4 points).
 - d. Brake piping passenger side clips. See Figure 76 (3 clips).
 - e. ABS speed sensor harness driver and passenger side. See Figure 77 (4 points).
 - f. Brake pipe retaining clip driver and passenger side. See Figure 76 (2 points).
 - g. Canister pipe. See Figure 78 (3 points).
 - h. Active suspension connector front right and left (if equipped).
 - i. Seat belt tension rod. Save the mounting bolts for reuse. See Figure 79.
 - j. Fuel tank protector by removing the fixing bolts.

		
<p>Figure 73 – Parking Brake Cable Passenger Side</p>	<p>Figure 74 – Parking Brake Cable Driver Side</p>	<p>Figure 75 – Wire Harness</p>
		
<p>Figure 76 – Brake Piping</p>	<p>Figure 77 – ABS Harness and Pipe</p>	<p>Figure 78 – Canister Pipe</p>
 <p style="text-align: center;">Figure 79 - Seat Belt Tension Rod</p>		

6. Remove body mount mounting nuts for body mounts #1, #2, #3 and #5. See Figure 80.

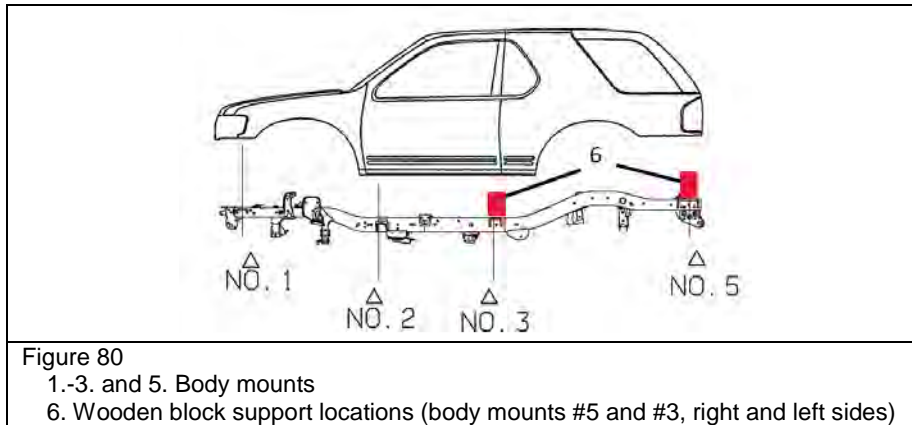

7. Using ratcheting straps, lash up the rear axle at the driver and passenger side. Start by placing one end of the strap above the axle at the driver side inside frame rail, route the other end of the strap down, underneath, the rear axle and then back up above the outside of the driver side frame rail. Connect both ends of the strap together and remove any slack. Repeat this process for the passenger side.
8. Lower the vehicle to the ground. Raise the rear of the body off of the frame and support.
9. Remove the 2 mounting bolts from the top of body mount number #5 (right and left sides) and remove the body mount.
10. Remove the top of body mount #3.

CAUTION: Failure to install the wooden blocks as directed below can create a dangerous situation in which the rear section of the frame rail may break off, collapse to the ground and cause serious personal injury to the technician during the repair as well as permanent frame damage, making the vehicle unreparable.

11. Using wooden blocks, support the body off of the frame. See Figures 81 and 82.
 - a. Body mount #5 should be 7.85 inches (200 mm) above the frame and body mount #3 should be at least 4.75 inches (120 mm).

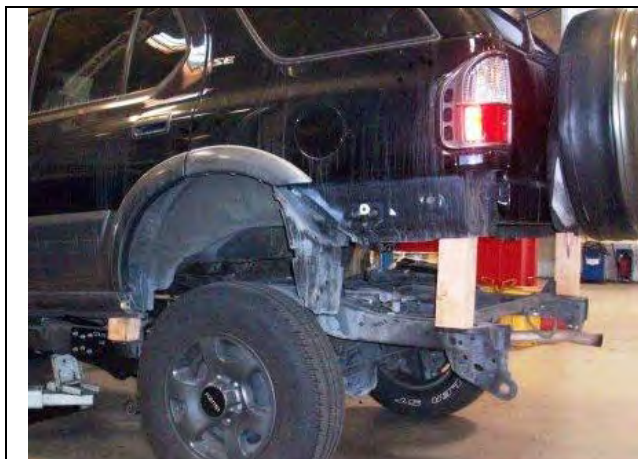

Figure 81 – Wood Blocks Installed at #5 Body Mount



Figure 82 – Wood Block Installed at #3 Body Mount

NOTE: When raising the vehicle, be sure that the body does NOT shift forward.

12. Remove the rear lower link front mounting bolts, on both driver and passenger sides. Discard the mounting bolts and nuts. New hardware is provided in the reinforcement bracket kit.
13. Raise the vehicle into the air.
14. Remove the rear trailing link front mount. See Figure 83 for reference.
 - a. Using a cutting wheel, cut just below or through the weld to remove the bracket.
 - b. Use a disk grinder to remove any excess material and smooth out the frame.

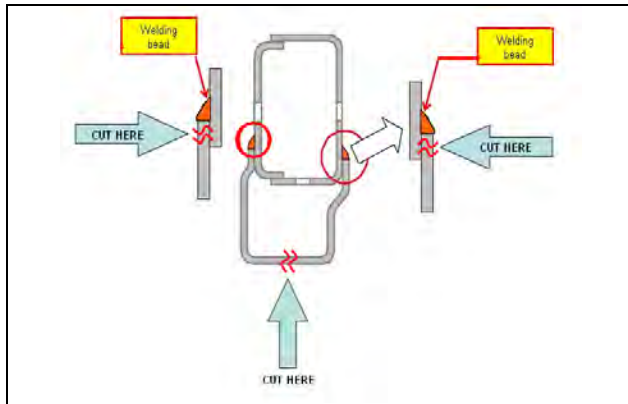

Figure 83 – Rear Trailing Link Removal



Figure 84 – Passenger Side Bracket Before Removal



Figure 85 – Frame After Bracket Removal

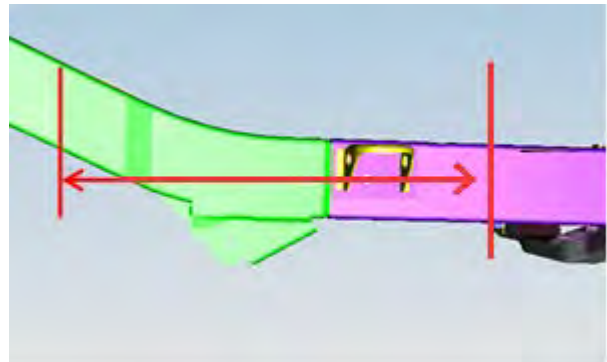

Figure 86 – Frame Rail Cleaning Area

15. Remove the frame hole plug from the driver and passenger side frame rails as shown in Figure 6. Discard the plug.
16. Using a hammer, knock on the outside of the frame rail to loosen any rust on the inside of the frame.
17. Using a wire brush and scraper, remove any loose coating material and rust from the entire outside frame rail. Clean the area 10 inches forward and rearward the bracket location.
18. Using “C” clamps and the provided studs and nuts (P/N 8-98174-543-0 and 8-97245-646-0), temporarily install both right and left brackets as shown in Figure 87.
 - a. Start by securing the bracket to the frame using the stud and nut at the upper link bracket.
 - b. Push the bracket up firmly against the frame and clamp into place with the “C” clamps. Be sure the clamps compress the bracket against the frame so there is no possibility of movement while marking the frame.



Figure 87 – Type “D” Bracket (temporary installation)

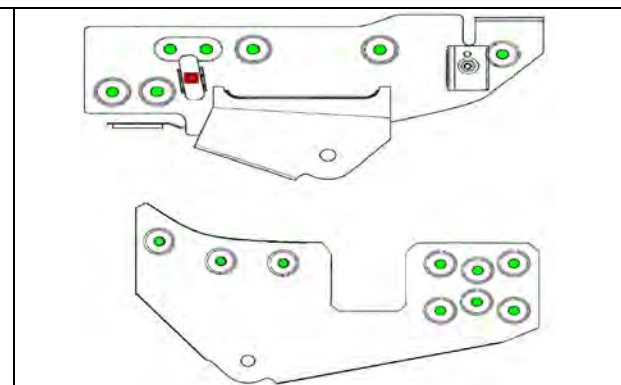

Figure 88 – 16 Green Dots for Pop-nut Locations (red square is required for clearance)

19. Using the 1/4" drill bit guide or equivalent, drill 1/4" pilot holes for each bracket mounting point into the frame rail, 16 holes for each bracket. See Figure 88.

IMPORTANT: Be sure the bracket does not move during the procedure.

20. Using a 1/4" drill bit, drill a hole in the frame through the passenger side reinforcement bracket brake clip mounting hole. See Figure 89.

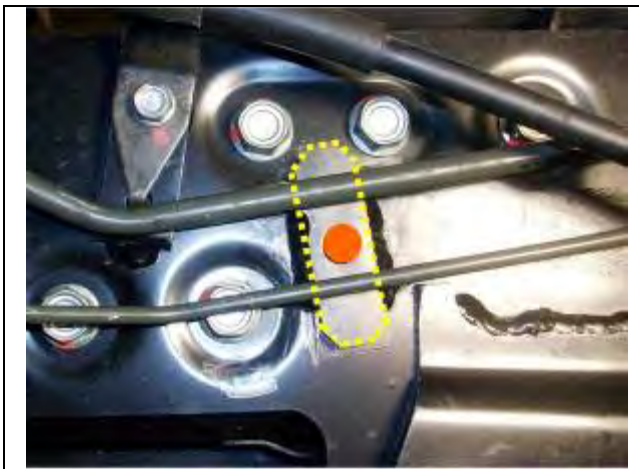

Figure 89

21. Remove both reinforcement brackets.

22. Locate the 1/4" hole drilled in Step 20. Use the 3/32" drill bit and finish drilling this location. Mark this location with tape or chalk. This hole is required to provide clearance for the passenger side brake pipe clip. See Figure 89.

IMPORTANT: Do not install a Pop-nut in this location. This hole is required clearance for the passenger side brake pipe clip.

23. Use the 3/32" drill to finish drilling all of the mounting holes.

24. Test fit a Pop-nut into each hole to be sure drilling is complete.

IMPORTANT: Do not attempt to round out (open the hole by pivoting the drill bit) the hole if the Pop-nut does not fit. Doing so will create an uneven seating surface for the Pop-nut. If the nut does not fit after drilling, your drill bit is worn out and needs to be sharpened or replaced.

25. Using a blow gun through the frame hole, blow any rust debris away from this area up and down the inside frame rail.

26. Install Pop-nuts (see tool manual for additional details).

- a. Before installing the Pop-nuts (P/N 8-98174-539-0), be sure the pressure regulator is adjusted between 72.5 and 87 psi (0.5-0.6MPa / 5-6bar) and, using the provided test pieces, test install 1-3 Pop-nuts onto the test plate to be sure they are seating properly. See Figures 90 and 91.

NOTE: Air pressure regulator adjustment is critical. Excessive air pressure will result in tool damage while low pressure may result in incorrect Pop-nut installation.

- b. When Installing Pop-nuts, be sure the Pop-nuts are completely seated against the frame before pulling the trigger. See Figure 34.
- c. After pulling trigger, continue to hold it down until the mandrel reverses direction. Once reversed, pull back slightly and the mandrel will unthread from the Pop-nut. See Pop-nut installer manual for details.

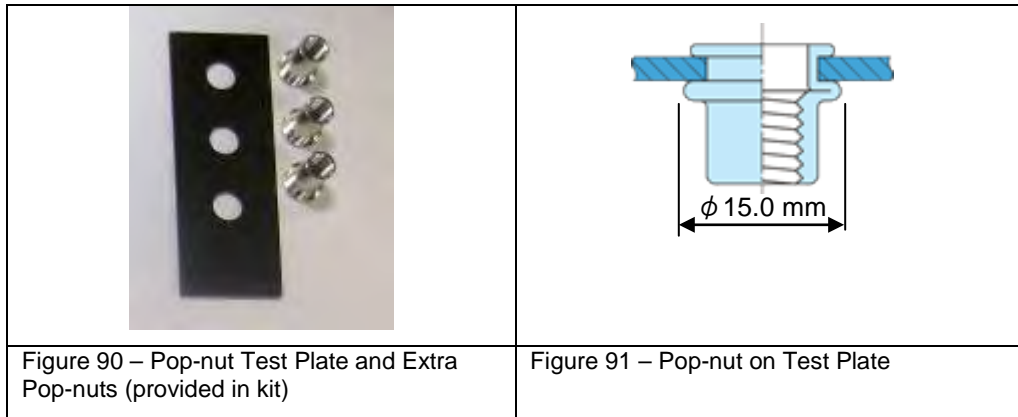

27. Temporarily install both right and left brackets again. Confirm all bolts can be properly started in each Pop-nut.
28. Remove both reinforcement brackets.
29. Using ¾” round labels, mask off the Pop-nuts. Using tape, mask off other related bracket mounting locations (see Figures 92 and 93). This is required to prevent Noxudol chemicals from coating the bracket mounting surfaces.
30. Follow Steps 6 through 12 in the section of this bulletin entitled, “Condition Two: Apply Noxudol 700 and Noxudol 300.”
31. Change to the spray valve and spray one light coat of Noxudol 700 onto inner and outer frame rail of both driver and passenger side. Wipe away any drips from the bottom of the frame rail. See Figure 94.
32. Change to the spray valve and spray one coat of Noxudol 300 one onto inner and outer frame rail of both driver and passenger side. See Figure 95.
33. Remove tape and labels from the masked areas called out in Step 29.

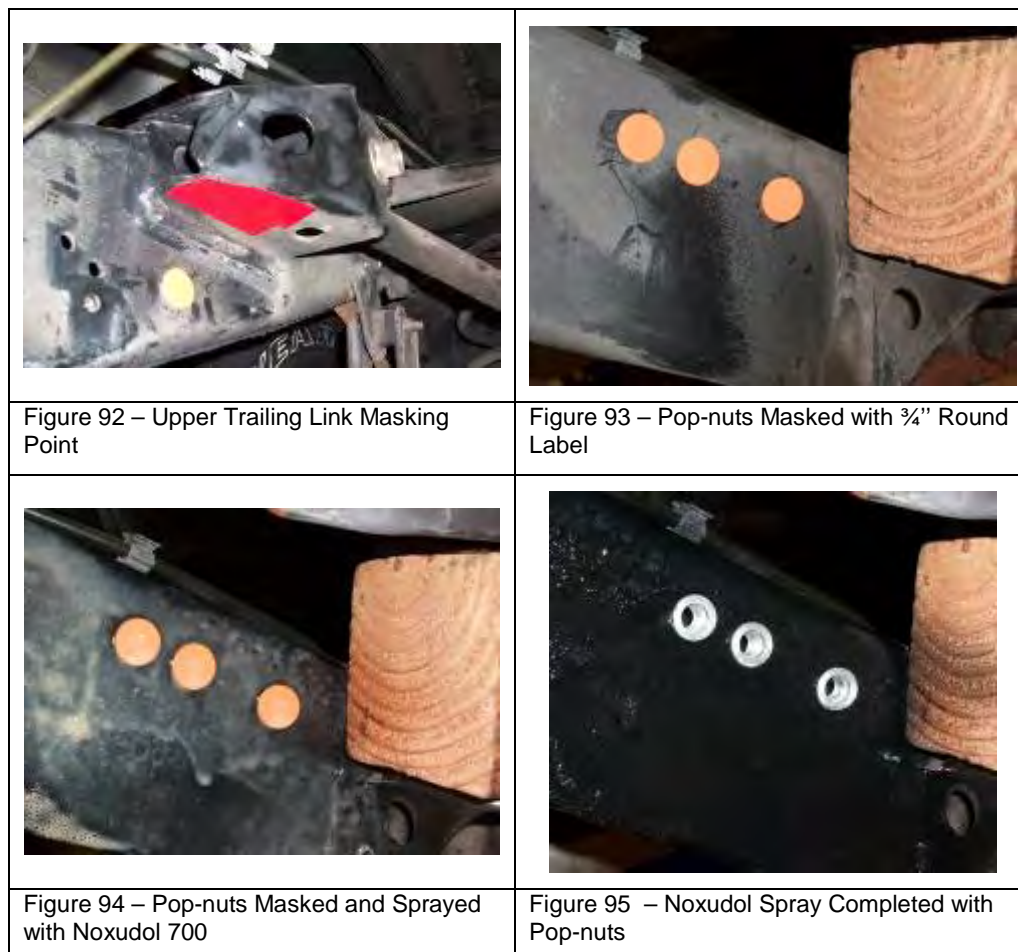

34. Install both reinforcement brackets using the stud and nut from Step 14 together with 32 new mounting bolts (P/N 8-98174-544-0) provided in the bracket kit.
35. Torque bolts according to the sequence and specifications shown in Figure 96.

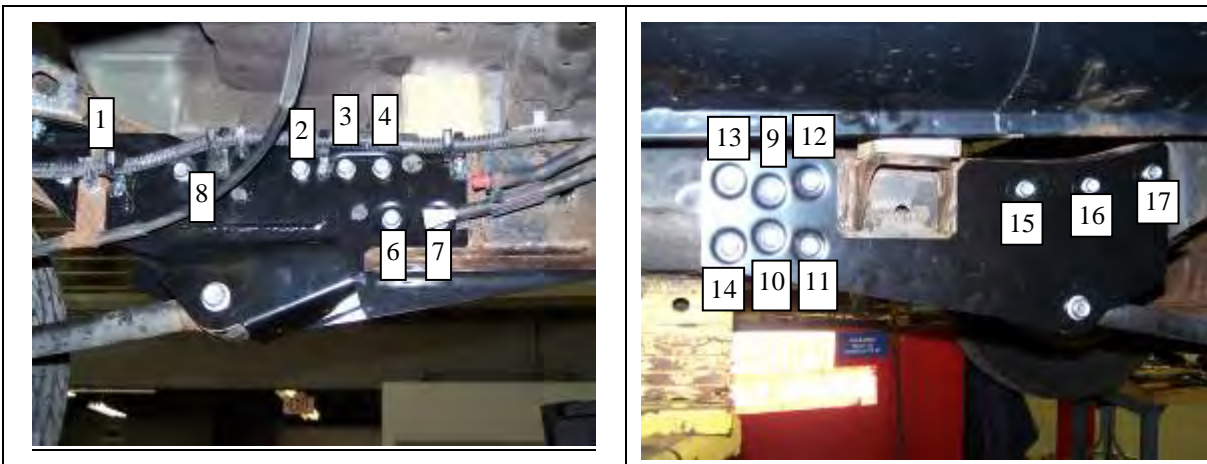

Figure 96

1. Upper link stud and nut; Torque to 50-55 Nm (37-40 lb ft)
- 2.-17. Bracket bolts; Torque to 25-30 Nm (18-22 lb ft)

36. Install both rear trailing links (new bolts P/N 0-29261-400-0 and nuts P/N 8-98181-530-0 provided in the kit) and secure but do not apply the final torque. Final torque must be applied with the vehicle resting on the ground.
37. Remove both ratcheting straps installed in Step 7.
38. Lower the vehicle to the ground.
39. Raise the body up enough to remove the wooden block supports.
40. Install #5 body mounts and torque bolts to specification. Torque: 50 Nm (37 lb ft).
41. Spray Noxudol 300 around the #3 body mount.
42. Lower the body down onto the frame and torque body mounts to specification. Torque: 50 Nm (37 lb ft).
43. Torque the both rear trailing link front mount mounting bolts to specification. Torque: 165 to 180 Nm (122-133 lb ft).
44. Raise the vehicle into the air and secure the following components:
 - a. Parking brake cable passenger side (1 point).
 - i. New bolt (2) P/N 0-28050-612-0; Torque: 6.5 to 8.5 Nm (57 to 75 lb in).
 - b. Parking brake cable driver side (1 point).
 - i. New bolt (2) P/N 0-28050-612-0; Torque: 6.5 to 8.5 Nm (57 to 75 lb in).
 - c. Wiring harness from frame driver side (6 points).
 - i. 4 points on included on new bracket.
 - d. Brake piping passenger side clips.
 - i. Frame rail (2 clips).
 1. V6 (P/N 8-97125-111-1)
 2. 4cyl (P/N 8-97236-077-0)
 - ii. 1 clip for new bracket position (P/N 9-98153-939-1) for all models.
 - e. ABS harness and piping right front fender well.
 - f. Brake pipe retaining clip driver and passenger side. See Figure 76 (2 points).
 - g. Canister pipe. See Figure 78 (3 points).
 - h. Active suspension connector front right and left (if equipped).
 - i. Seat belt tension rod. See Figure 79
 - i. Reuse original bolts; Torque: 6.5 to 8.5 Nm (57 to 75 lb in).

45. Reinstall the fuel tank assembly per service manual:
 - a. Install fuel tank protector and tighten the fixing bolts and nut in location 6. Torque: 20 Nm (15 lb ft).
 - b. Install fuel supply line at fuel filter using new clamp (P/N 8-97148-892-1).
 - c. Install fuel return line at fuel filter using new clamp (P/N 8-94238-572-0).
 - d. Install fuel tank. Install new parts at locations 2, 3 and 5 as shown in Figure 97.

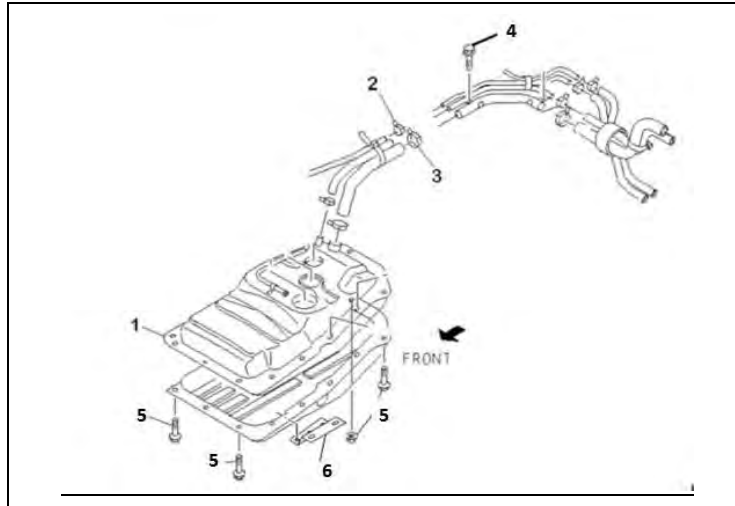

Figure 97

1. Fuel Tank
2. Fuel Line Clip
'01-'04MY 8-94242-034-0
3. Fuel Line Clip
'01-'04MY 8-97237-146-0
4. Fuel Pipe Mounting Bolts
5. Fuel Tank Mounting Bolts and Nut
Nut 8-97142-595-0
Bolt 8-97174-300-1
6. Fuel Tank Protector Bolts and Washers
Bolts: 8-98174-544-0
Washers: 0-9161-4810-0

46. Install the following components as per the service manual.
 - a. Rear bumper assembly.
 - b. Exhaust silencer. Replace gaskets (P/N 8-97148-757-1).
 - c. Linear EGR valve. Replace gasket (for V6, P/N 8-97104-317-2, for 4cyl, P/N 8-90467-547-0).
 - d. Front grill.
 - e. Running boards or side steps (if equipped).
47. Apply the campaign label (see "Applying the Campaign Label" in this bulletin).

APPLYING THE CAMPAIGN LABEL

1. Using a ball-point pen, fill in a campaign label (Part No. 2-90028-700-0) with Campaign Number 13V-547, Isuzu service facility code, and repair date.
2. Affix the campaign label onto the driver's side B-pillar.

<b style="font-size: 1.5em; color: red;">ISUZU CAMPAIGN NUMBER
_____ DEALER CODE: _____
REPAIR DATE: _____
<small>P/N 2-90028-700-0</small>

CLAIM INFORMATION

IMPORTANT NOTICE: If there are questions at any point during this Inspection or Repair, Please contact one of our National Operation Managers at our Service Facility Support line. (1-800-533-0244, Option 2.) Please have your service facility code and repair order information available when you call.

If there are any claim processing questions, please send your inquiry to warranty@isza.com or contact one of our National Operations Managers at the Service Facility Support Line. (1-800-533-0244, Option 2.)

Submit a Campaign Claim with the information indicated below:

Operation	Oper. No.	Task	Special Instr.	Time	Failed P/N	Trouble Code	Sublet Code*	Sublet Allow
Regional Campaign 13V-547	119975	Inspect and Complete Condition One Repair		0.3	2-900028-700-0	07	NX	5.50
	119976	Inspect and Complete Condition Two Repair	Add 1.0 if equipped with running boards	0.4	2-900028-700-0	07	NX	27.83
	119977	Inspect and Complete Condition Three Repair	Add 1.0 if equipped with running boards	1.4	8-98181-806-0 or 8-98181-813-0	07	NX	27.83
	119978	Inspect and Complete Condition Four Repair	Add 1.0 if equipped with running boards	10.0	8-98181-814-0	07	NX	50.16
	11997i	Inspect and Report	Authorization required	0.8	N/A	07	N/A	N/A

NOTES:

- Noxudol packaging includes enough product to complete multiple vehicles. Sublet NX has been created for these labor operations only and include normal markup.
- For any other parts or sublet codes, normal claims submission requirements apply.
- Labor Time includes 0.1 hours administrative time allowance.

Refer to the Isuzu ICS Claims Processing Manual for details on Campaign Claim Submission.

“IMPORTANT SAFETY RECALL”

This notice applies to your vehicle, <VIN>

DECEMBER 13, 2013

Dear Isuzu Customer:

This notice is sent to you in accordance with the requirements of the National Traffic and Motor Vehicle Safety Act. Isuzu Motors Limited has decided that a defect which relates to motor vehicle safety exists in certain model year (MY) 2003 Rodeo Sport, 2003-2004 Rodeo and 2003-2004 Axiom vehicles originally or currently registered in the following states (the “Salt Belt”): Maine, New Hampshire, Vermont, Massachusetts, Rhode Island, Connecticut, New York, New Jersey, Pennsylvania, Delaware, Maryland, the District of Columbia, West Virginia, Ohio, Indiana, Kentucky, Michigan, Illinois, Wisconsin, Minnesota, Iowa, and Missouri.

WHAT IS THE CONDITION?

Certain Isuzu vehicles that have experienced sustained exposure to highly corrosive materials used in some jurisdictions for road deicing purposes may experience excessive corrosion in the vicinity of the forward mounting point bracket for the left or right rear suspension lower link prematurely. In certain extreme cases, excessive corrosion in this vicinity may result in a lower link bracket becoming detached from the frame, which can affect vehicle handling and potentially cause a crash.

WHAT WE WILL DO

An Isuzu service facility will inspect the left and right forward mounting point bracket areas of the rear suspension lower link of your vehicle to determine if corrosion is present in those areas. For vehicles in which little or no corrosion is observed in those areas, the service facility will treat the areas with an anti-corrosion compound to reduce the likelihood of additional corrosion in those areas in the future. In the case in which corrosion has damaged the area around either or both of the forward mounting point brackets of the rear suspension lower link and affected their connection to the vehicle’s frame, one of two different types of reinforcement brackets will be installed, depending upon the extent of the corrosion. In the event that the reinforcement bracket would not be effective, Isuzu will provide an alternative remedy. This service will be performed for you at **no charge**.

For the majority of vehicles, the inspection and the application of the anti-corrosion compound will be all that is necessary, and that work will take approximately ninety minutes. If, however, the corrosion in the area(s) specified above is so extensive that it is necessary to install new reinforcement brackets, the repairs will take approximately three hours or ten hours, depending on which type of bracket is used. Of course, depending upon the service facility’s work schedule and/or the need to have the necessary parts delivered to the service facility, it may be necessary for you to make your vehicle available for a longer period of time.

WHAT YOU SHOULD DO

Please call the Isuzu Special Assistance Center at 1-877-460-0706 or visit our website at www.isuzu.com to identify the Isuzu service facility that is closest to you. Then, you should contact the service facility to arrange an appointment to bring your vehicle in to have the inspection and the remedy work performed. Please present this letter or refer to Safety Recall No. 13V-547.

If your vehicle is not drivable due to the conditions noted in this letter, please call the Isuzu Special Assistance Center at 1-877-460-0706 so we can arrange to have the vehicle transported to an Isuzu service facility to be inspected and to receive an appropriate remedy. That transportation will be provided at **no charge**.

REIMBURSEMENT

If you have already paid for repairs to address the condition covered by this recall, you may be eligible to have those costs reimbursed. The enclosed form explains the terms under which reimbursement may be available and how to request reimbursement. Among other things, you will need to provide the original paid receipt or invoice verifying the repair and the costs of that repair.

If you have any questions regarding this matter you can visit our website at www.isuzu.com or contact our Special Assistance Center at 1-877-460-0706.

If you have any problems obtaining the needed repair or believe that this repair has not been made within a reasonable time, you may contact:

National Owner Relations Department
Isuzu Motors America, LLC
1400 S. Douglass Road
Suite 100
Anaheim, CA 92806

If you still are not satisfied, you may submit a complaint to the Administrator, National Highway Traffic Safety Administration, 1200 New Jersey Avenue, S.E., Washington, D.C. 20590, or call the toll-free Vehicle Safety Hotline at 1-888-327-4236 (TTY: 1-800-424-9153); or go to <http://www.safercar.gov>.

If you are a vehicle lessor, Federal law requires that any vehicle lessor receiving this recall notice must forward a copy of this notice to the lessee within ten days.

We regret any inconvenience that this action may cause you.

Sincerely,

ISUZU MOTORS AMERICA, LLC

OWNER LETTER (MORE THAN 10 YEARS OLD)

“IMPORTANT SAFETY RECALL”

This notice applies to your vehicle, <VIN>

DECEMBER 13, 2013

Dear Isuzu Customer:

This notice is sent to you in accordance with the requirements of the National Traffic and Motor Vehicle Safety Act. Isuzu Motors Limited has decided that a defect which relates to motor vehicle safety exists in certain model year (MY) 2003 Rodeo Sport, 2003-2004 Rodeo and 2003-2004 Axiom vehicles originally or currently registered in the following states (the “Salt Belt”): Maine, New Hampshire, Vermont, Massachusetts, Rhode Island, Connecticut, New York, New Jersey, Pennsylvania, Delaware, Maryland, the District of Columbia, West Virginia, Ohio, Indiana, Kentucky, Michigan, Illinois, Wisconsin, Minnesota, Iowa, and Missouri.

WHAT IS THE CONDITION?

Certain Isuzu vehicles that have experienced sustained exposure to highly corrosive materials used in some jurisdictions for road deicing purposes may experience excessive corrosion in the vicinity of the forward mounting point bracket for the left or right rear suspension lower link prematurely. In certain extreme cases, excessive corrosion in this vicinity may result in a lower link bracket becoming detached from the frame, which can affect vehicle handling and potentially cause a crash.

WHAT WE WILL DO

An Isuzu service facility will inspect the left and right forward mounting point bracket areas of the rear suspension lower link of your vehicle to determine if corrosion is present in those areas. For vehicles in which little or no corrosion is observed in those areas, the service facility will treat the areas with an anti-corrosion compound to reduce the likelihood of additional corrosion in those areas in the future. In the case in which corrosion has damaged the area around either or both of the forward mounting point brackets of the rear suspension lower link and affected their connection to the vehicle’s frame, one of two different types of reinforcement brackets will be installed, depending upon the extent of the corrosion. In the event that the reinforcement bracket remedy would not be effective, Isuzu will provide an alternative remedy. This service will be performed for you at **no charge**, subject to the limitations set out in the following paragraph.

Please note that because your vehicle was originally purchased more than ten years before November 1, 2013, which is the date on which Isuzu advised the National Highway Traffic Safety Administration of this recall, Isuzu is not required to provide a remedy at no charge. However, as a courtesy, if you present your vehicle to an Isuzu service facility no later than twelve (12) months from the date of this letter, Isuzu will voluntarily provide this remedy at no charge. If you wish to obtain the remedy after the expiration of this one-year period, you will need to pay for the necessary parts and labor. The current Manufacturer’s Suggested Retail Price (“MSRP”) of the anti-corrosion compound is between approximately \$27.00 and approximately \$54.00, depending on how many cans of the compound are required. However, if your vehicle requires reinforcement brackets, the MSRP of the bracket kits plus the required anti-corrosion compound is currently approximately \$285.00 or approximately \$551.00, depending on which type of bracket is required. Labor charges will be in addition to the cost of the required parts.

For the majority of vehicles, the inspection and the application of the anti-corrosion compound will be all that is necessary, and that work will take approximately ninety minutes. If, however, the corrosion in the area(s) specified above is so extensive that it is necessary to install new reinforcement brackets, the repairs will take approximately three hours or ten hours, depending on which type of bracket is used. Of course, depending upon the service facility’s work schedule and/or the need to have the necessary parts delivered to the service facility, it may be necessary for you to make your vehicle available for a longer period of time.

WHAT YOU SHOULD DO

Please call the Isuzu Special Assistance Center at 1-877-460-0706 or visit our website at www.isuzu.com to identify the Isuzu service facility that is closest to you. Then, you should contact the service facility to arrange an appointment to bring your vehicle in to have the inspection and the remedy work performed. Please present this letter or refer to Safety Recall No. 13V-547.

If your vehicle is not drivable due to the conditions noted in this letter, please call the Isuzu Special Assistance Center at 1-877-460-0706 so we can arrange to have the vehicle transported to an Isuzu service facility to be inspected and to receive an appropriate remedy. That transportation will be provided at **no charge**.

REIMBURSEMENT

If you have already paid for repairs to address the condition covered by this recall, you may be eligible to have those costs reimbursed. The enclosed form explains the terms under which reimbursement may be available and how to request reimbursement. Among other things, you will need to provide the original paid receipt or invoice verifying the repair and the costs of that repair.

If you have any questions regarding this matter you can visit our website at www.isuzu.com or contact our Special Assistance Center at 1-877-460-0706.

If you have any problems obtaining the needed repair or believe that this repair has not been made within a reasonable time, you may contact:

National Owner Relations Department
Isuzu Motors America, LLC
1400 S. Douglass Road
Suite 100
Anaheim, CA 92806

If you still are not satisfied, you may submit a complaint to the Administrator, National Highway Traffic Safety Administration, 1200 New Jersey Avenue, S.E., Washington, D.C. 20590, or call the toll-free Vehicle Safety Hotline at 1-888-327-4236 (TTY: 1-800-424-9153); or go to <http://www.safercar.gov>.

If you are a vehicle lessor, Federal law requires that any vehicle lessor receiving this recall notice must forward a copy of this notice to the lessee within ten days.

We regret any inconvenience that this action may cause you.

Sincerely,

ISUZU MOTORS AMERICA, LLC