

# IMPORTANT UPDATE OCTOBER 8, 2014

## TECHNICAL INSTRUCTIONS FOR SAFETY RECALL D0B SUB HARNESS (FILTER) INSTALLATION 2003 – 2004 MODEL YEAR MATRIX

***UPDATED OCTOBER 8, 2014***

**Updated 10/8/14**

- Flow chart updated. Health check now required along with a list of DTC's to determine Airbag Sensor replacement and the addition of technical skill lever requirements.

**Updated 5/13/13**

- The inspection has been updated to clarify the request for DTCs (if present) for MAC part release [\(SECTION VI\)](#)

**Updated 5/1/13**

- The inspection has been updated to request that DTCs (if present) are recorded for MAC part release [\(SECTION VI\)](#)

**Updated 4/15/13**

- The airbag sensor assembly part numbers have been updated [\(SECTION III\)](#)

**Updated 4/2/13**

- The inspection process at STEPS 1 & 2 have been updated to clarify the inspection process [\(SECTION VI\)](#)

All dealership associates involved in the recall process are required to successfully complete E-Learning course SC13A. To ensure that all vehicles have the repair performed correctly; technicians performing this recall repair are required to currently hold at least one of the following certifications levels:

- Toyota Expert (Electrical)
- Master
- Master Diagnostic Technicians

## I. OPERATION FLOW CHART

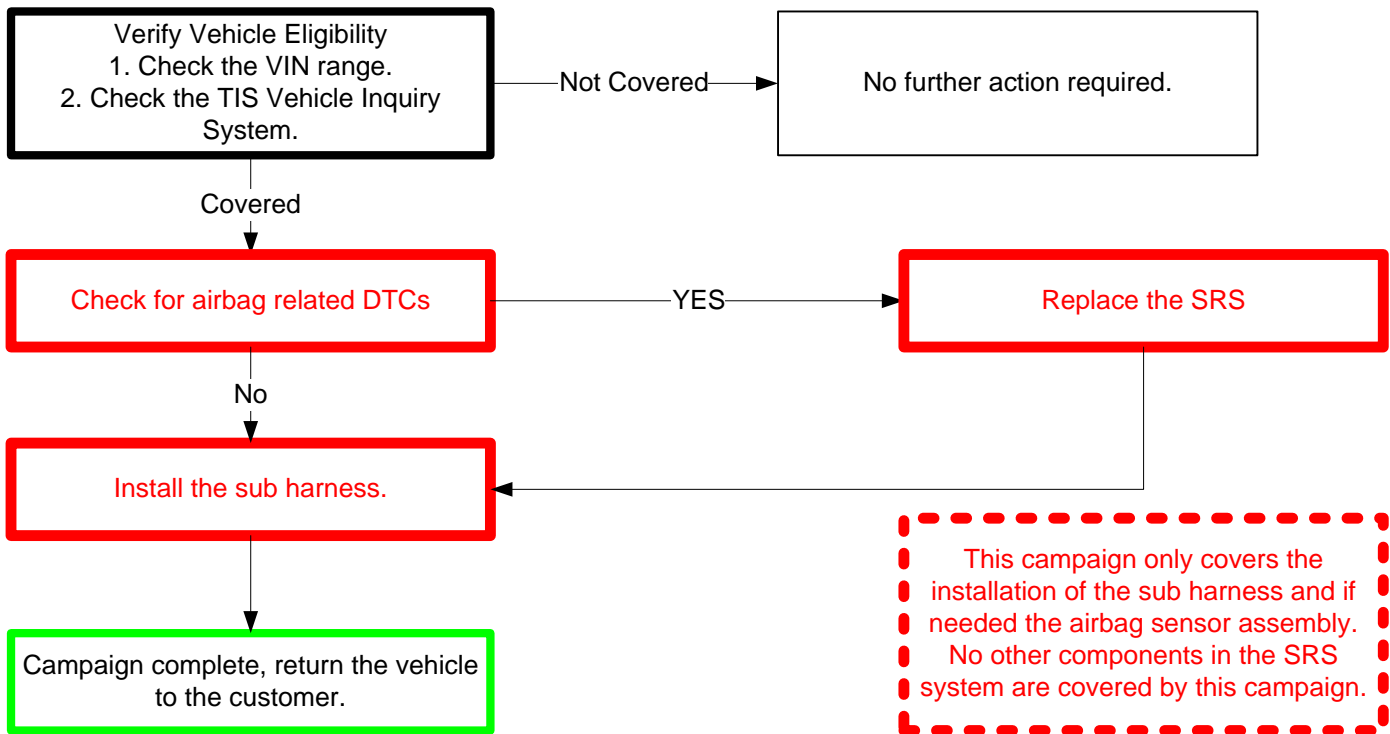

## II. IDENTIFICATION OF AFFECTED VEHICLES

### A. INVOLVED VEHICLES

#### NOTE:

- Check the TIS Vehicle Inquiry System to confirm the VIN is involved in this Safety Recall, and that the campaign has not already been completed prior to dealer shipment or by another dealer.
- TMS warranty will not reimburse dealers for repairs conducted on vehicles that are not affected or were completed by another dealer.

## III. PREPARATION

### A. PARTS

**All vehicles require the installation of this kit.**

Part Number	Part Description	Quantity
04002-66112	Airbag Harness Kit*	1
*The kit above includes the following parts.		
-	Airbag sub harness	1
-	Water guard sheet	1
-	Cable tie	4*

\*Only 2 cable ties are needed for the repair, 2 extra ties are also provided as supplements.

**The Airbag Sensor should only be replaced after performing a Health Check as indicated in STEP 1. Parts will be placed on recovery and subject to claim debit for inappropriate replacement.**

Part Number	Part Description	Quantity
89170-01011	Airbag Sensor Assembly (Without Side Airbag)	1
89170-01021	Airbag Sensor Assembly (With Side Airbag)	1

## B. TOOLS & EQUIPMENT

- Standard hand tools
- Molding remover set
- Torque wrench
- Tape measure
- Techstream
- Vinyl tape

## IV. BACKGROUND

The Electronic Control Module (ECM) for the Supplemental Restraint System (SRS) in these vehicles could have been manufactured with integrated circuits that are susceptible to internal short circuiting when exposed to certain electrical noise from various vehicle electrical components. If internal short circuiting occurs, the front airbag(s) and/or seat belt pretensioners could inadvertently deploy. An airbag that deploys inadvertently can, under some circumstances, increase the risk of minor injury and the possibility of a crash.

## V. COMPONENTS

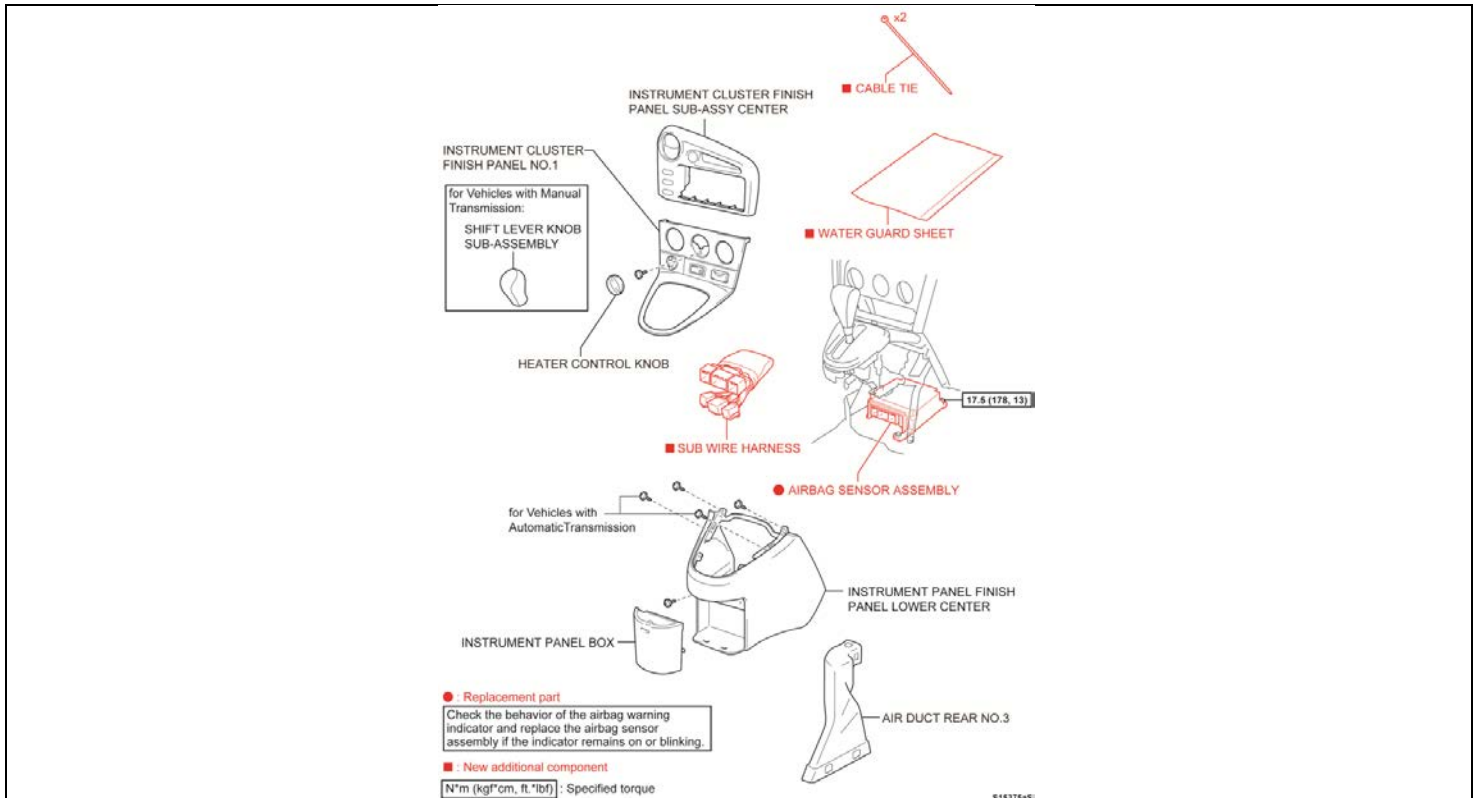

## VI. WORK PROCEDURE



This campaign only covers the installation of the sub harness and if needed the airbag sensor assembly. No other components in the SRS system are covered by this campaign.

### 1. PERFORM A HEALTH CHECK

- Using Techstream, perform a health check to confirm if there are any airbag related DTCs present in the system (**Both current or history**). If any of the DTC's stored in the vehicles SRS system match the list below, proceed to Step 2.

#### NOTES:

- Ensure that the Techstream software is 9.2 or higher.
- On the "connect to vehicle" screen, enter the VIN number to ensure that the vehicle information is uploaded to TIS.
- Record the SRS DTCs as they are used to confirm the vehicles final state after repair and aid in any additional discussions needed with the customer.
- If there is no communication between the SRS ECU and Techstream DTCs cannot be retrieved, in this scenario state, continue to Step 2 and replace the SRS ECU called out in step 10.

DTC No.	Detection Item	DTC No.	Detection Item
B0100	Short in D squib circuit	B0131	Open in P/T squib (RH) circuit
B0101	Open in D squib circuit	B0132	Short in P/T squib (RH) circuit (to ground)
B0102	Short in D squib circuit (to ground)	B0133	Short in P/T squib (RH) circuit (to B+)
B0103	Short in D squib circuit (to B+)	B0135	Short in P/T squib (LH) circuit
B0105	Short in P squib circuit	B0136	Open in P/T squib (LH) circuit
B0106	Open in P squib circuit	B0137	Short in P/T squib (LH) circuit (to ground)
B0107	Short in P squib circuit (to ground)	B0138	Short in P/T squib (LH) circuit (to B+)
B0108	Short in P squib circuit (to B+)	B1100	Airbag sensor assembly malfunction
B0110	Short in side squib (RH) circuit	B1180	Short in D squib (2nd step) circuit
B0111	Open in side squib (RH) circuit	B1181	Open in D squib (2nd step) circuit
B0112	Short in side squib (RH) circuit (to ground)	B1182	Short in D squib (2nd step) circuit (to ground)
B0113	Short in side squib (RH) circuit (to B+)	B1183	Short in D squib (2nd step) circuit (to B+)
B0115	Short in side squib (LH) circuit	B1185	Short in P squib (2nd step) circuit
B0116	Open in side squib (LH) circuit	B1186	Open in P squib (2nd step) circuit
B0117	Short in side squib (LH) circuit (to ground)	B1187	Short in P squib (2nd step) circuit (to ground)
B0118	Short in side squib (LH) circuit (to B+)	B1188	Short in P squib (2nd step) circuit (to B+)
B0130	Short in P/T squib (RH) circuit		

b) If no DTC's are present continue to STEP 2 but skip Step 10



**This campaign only covers the installation of the sub harness and if needed the airbag sensor assembly. No other components in the SRS system are covered by this campaign.**

## 2. DISCONNECT THE NEGATIVE BATTERY TERMINAL



- Wait at least 90 seconds after disconnecting the cable from the negative battery terminal to prevent airbag and seat belt pre-tensioner deployment.
- Follow all precautions as outlined on TIS before servicing the SRS system.
- Remove all panels carefully to avoid damage.

## 3. SET THE PARKING BRAKE

## 4. SLIDE THE DRIVER AND PASSENGER SEAT TO THE REAR MOST POSITION

## 5. REMOVE THE FOLLOWING

- a) Instrument cluster finish panel sub-assembly center.
- b) Shift lever knob sub-assembly (*manual trans only*).
- c) Heater control knob.
- d) Instrument cluster finish panel No. 1.
- e) Instrument panel box.
- f) Instrument panel finish panel lower center.

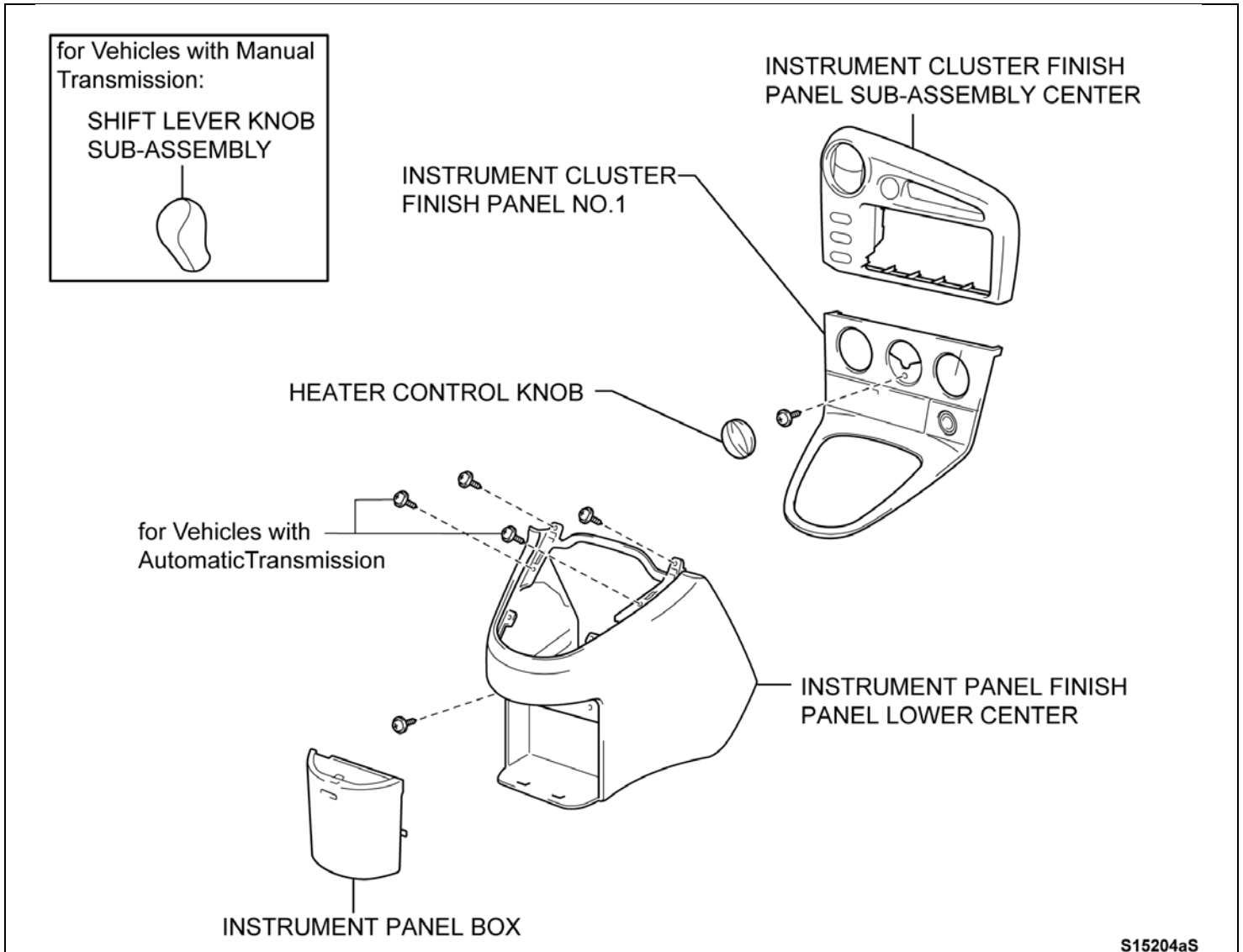

S15204aS



#### 6. REMOVE THE FLOOR CARPET LH

- a) Remove the clip and pull back the floor carpet.

**NOTE:**

- Wear protective gloves.
- Remove the floor carpet enough to gain access to the airbag sensor.

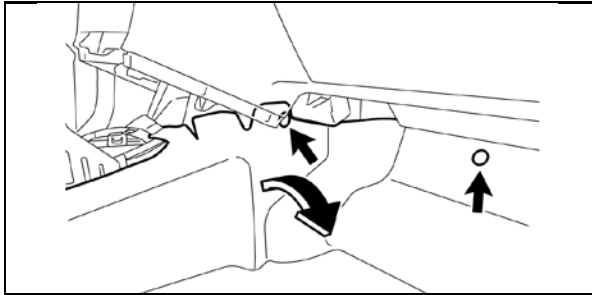

#### 7. REMOVE THE FLOOR CARPET RH

- a) Remove the 2 clips and pull back the floor carpet.

**NOTE:**

- Wear protective gloves.
- Remove the floor carpet enough to gain access to the airbag sensor.

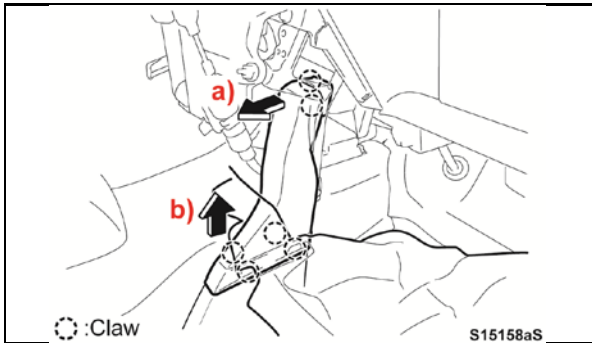

#### 8. REMOVE AIR DUCT REAR No. 3

- a) Pull the upper portion of the duct rearward to disengage the 2 upper claws.
- b) Pull the bottom portion of the duct upward to disengage the 4 claws and remove the duct.

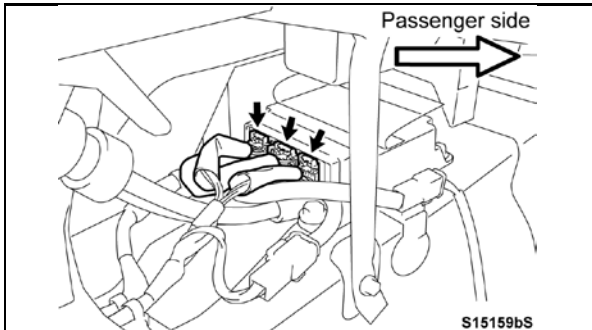

#### 9. DISCONNECT THE AIRBAG SENSOR CONNECTORS

- a) Disconnect the 3 connectors.



Only replace the airbag sensor assembly if DTC's are found as described in STEP 1. If no DTC's were detected, skip this step and proceed to STEP 11.

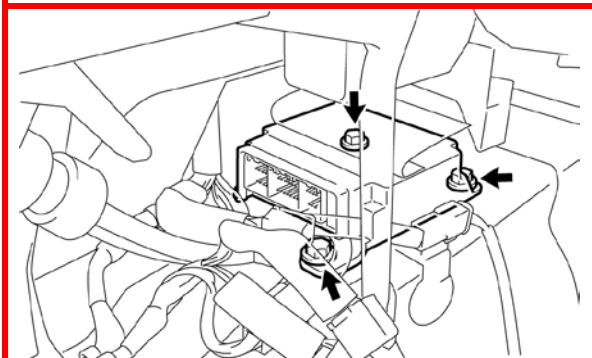

#### 10. REPLACE THE AIRBAG SENSOR ASSEMBLY

- a) Remove the 3 bolts and the airbag sensor assembly.
- b) Install a **NEW** airbag sensor assembly, then continue to **STEP 12**.

**Torque: 13ft. lbf (17.5N·m)**

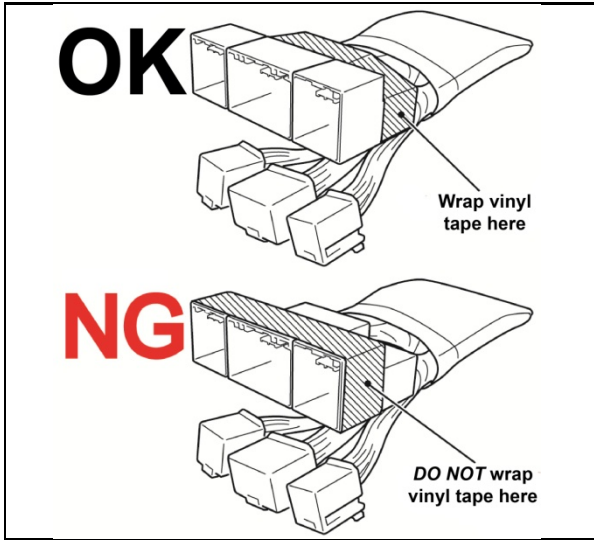

### 11. PREPARE THE SUB HARNESS

- a) To prevent noise, secure the 3 female connectors together with vinyl tape.

**STOP** To prevent the tape from interfering with the connectors, **DO NOT** wrap the tape around the front portion of the connectors.

### 12. POSITION THE SUB HARNESS

- a) Fold back the plastic sheet on the top of the airbag sensor.

**NOTE: DO NOT** remove the plastic sheet as it will cause the sensor label to peel off.

- b) Place the **NEW** sub harness on top of the airbag sensor.

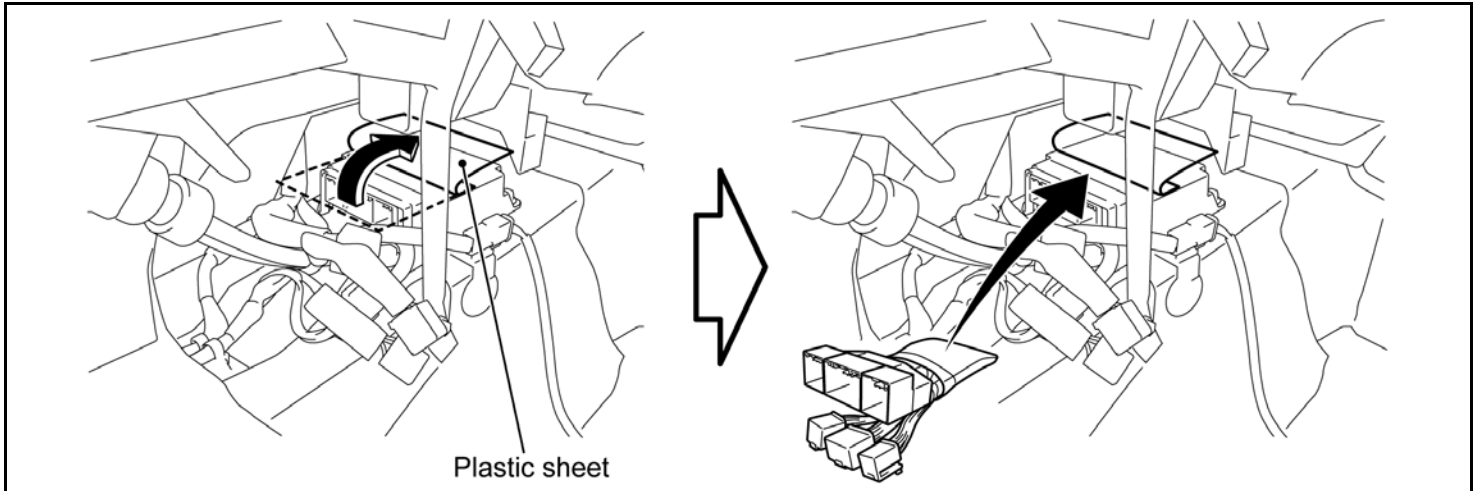

Plastic sheet

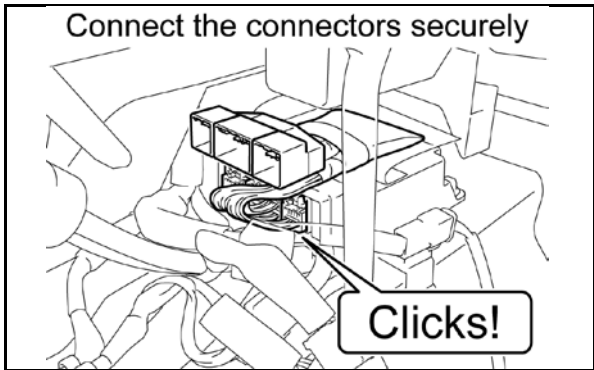

Connect the connectors securely

Clicks!

### 13. CONNECT THE SUB HARNESS

- a) Connect the 3 **NEW** connectors to the airbag sensor.



### Manual Trans

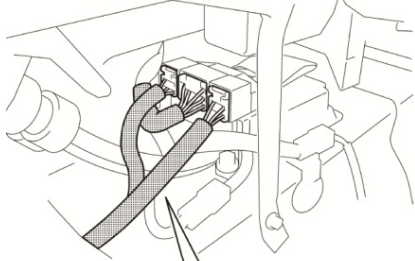

Pass the sub wire harness to the right of the shift cable.

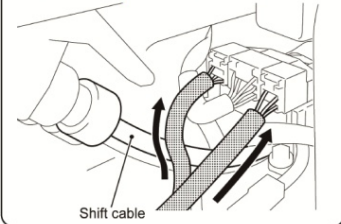

### Auto Trans

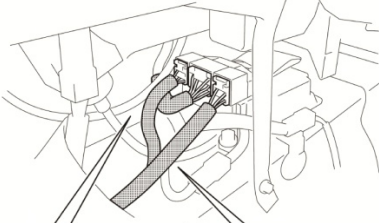

Pass the sub wire harness under the parking lock cable.

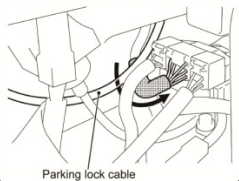

Pass the sub wire harness to the right of the shift cable.

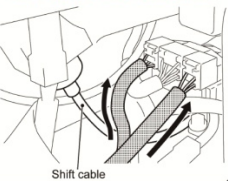

- b) Connect the 3 vehicle-side connectors to the **NEW** sub harness. Reference the correct illustration based on transmission type for wire routing.

## 14. INSTALL THE WATER GUARD SHEET

- a) Position the water guard sheet over the airbag sensor and sub harness.

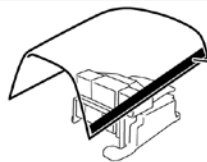

Position the adhesive tape to the side toward the front passenger seat.

for Vehicles with Automatic Transmission

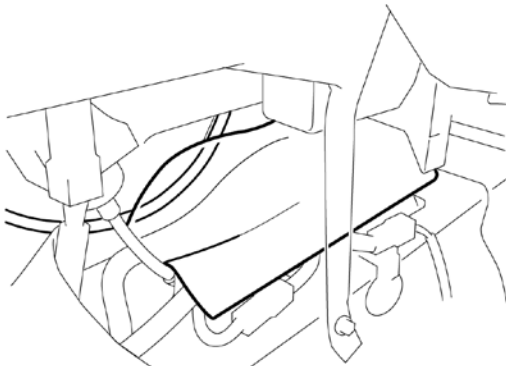

for Vehicles with Manual Transmission

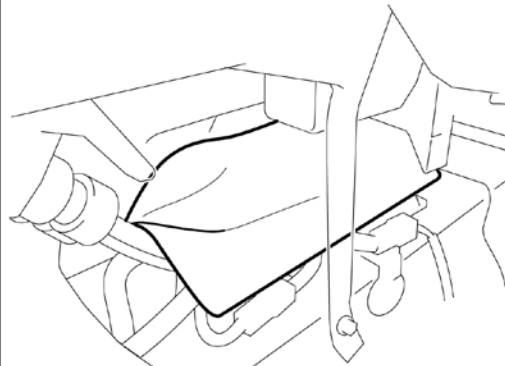



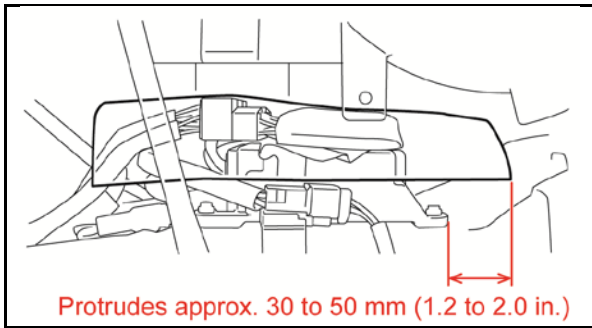

- b) Position the sheet so that the edge protrudes 1.2 to 2.0 in. (30 to 50 mm) past the back side of the airbag sensor.

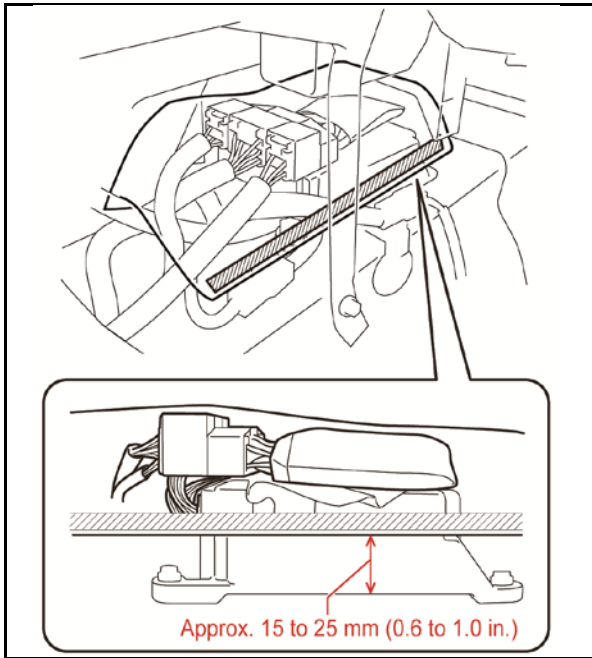

- c) Adhere the tape on the sheet to the right side of the airbag sensor approximately 0.6 to 1.0 in. (15 to 25 mm) above the bottom end of the sensor.

- d) Confirm the sheet has been positioned correctly.

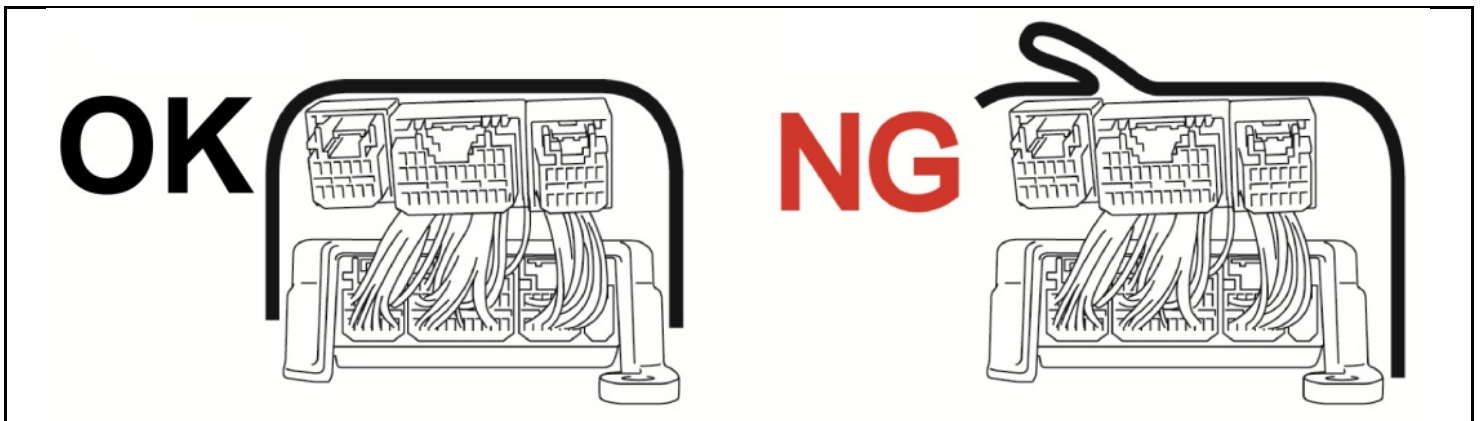

- e) Pass a cable tie through the space under the airbag sensor, then connect another cable tie.

**NOTE:**

- Only 2 cable ties are needed for the repair, 2 extra ties are also provided as supplements.
- If it is difficult to pass the cable underneath the airbag sensor, loosen the 3 bolts that fasten the sensor. Torque: 13ft. lbf (17.5N-m)

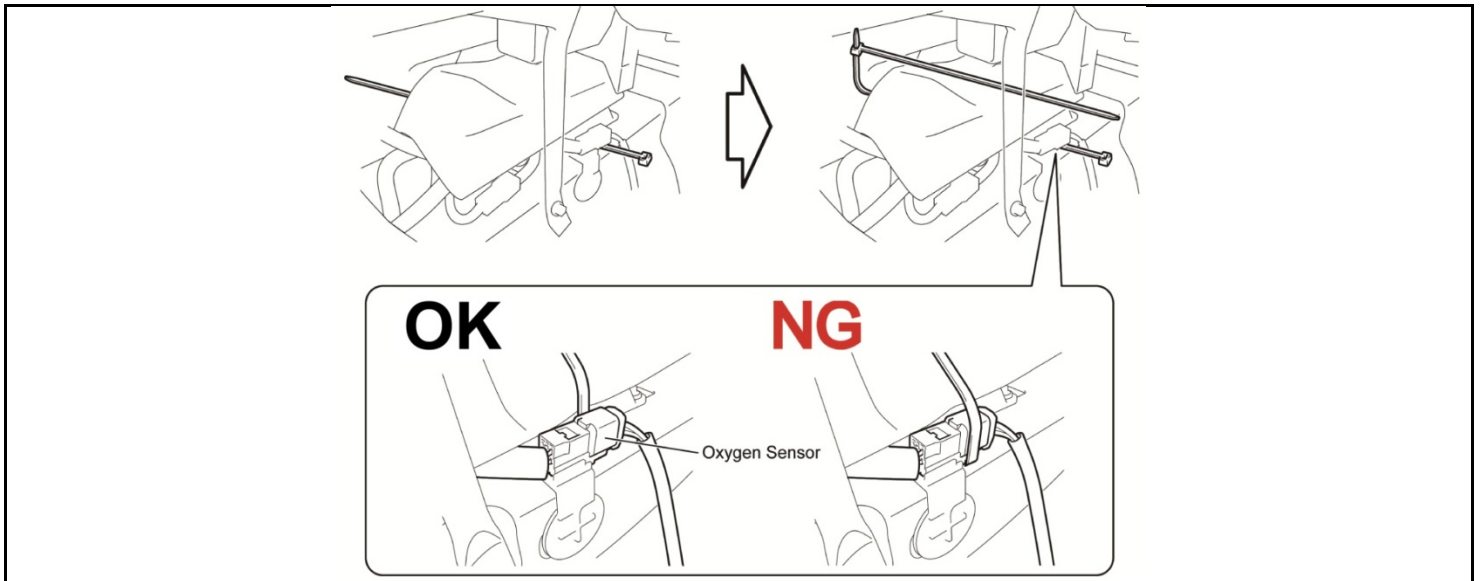

- f) Join the cable ties and secure the sub harness, water guard, and airbag sensor together.
- g) Cut any excess length from the cable tie.

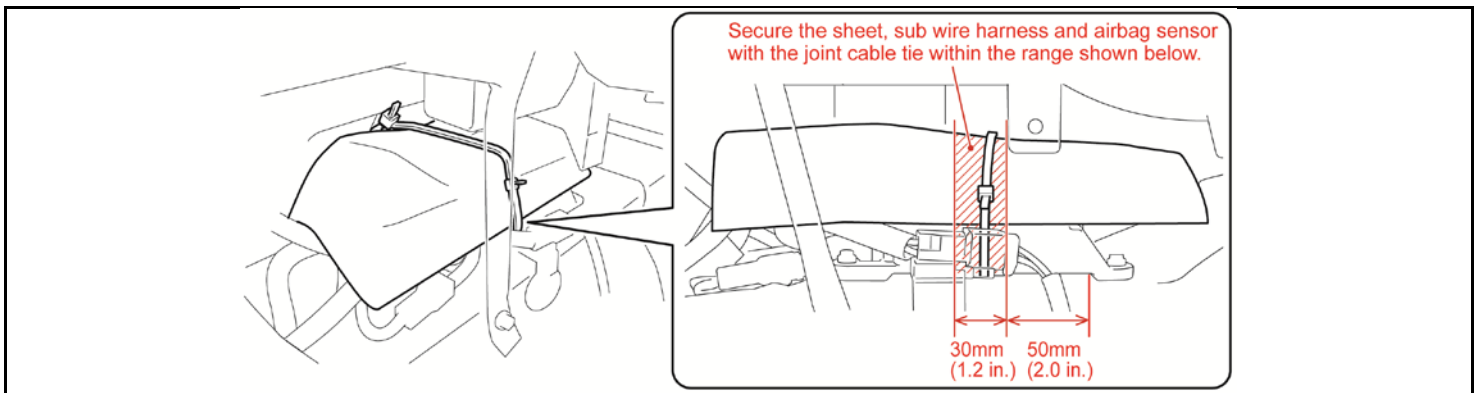

- The water guard sheet is critical to prevent water from the air conditioner from dripping on the airbag sensor, confirm it is positioned and adhered correctly.
- **DO NOT** bind the oxygen sensor harness/connector with the cable ties.
- If the cable tie or sheet is affixed incorrectly, the sub harness may not be fixed properly.

### 15. REINSTALL AIR DUCT REAR No. 3

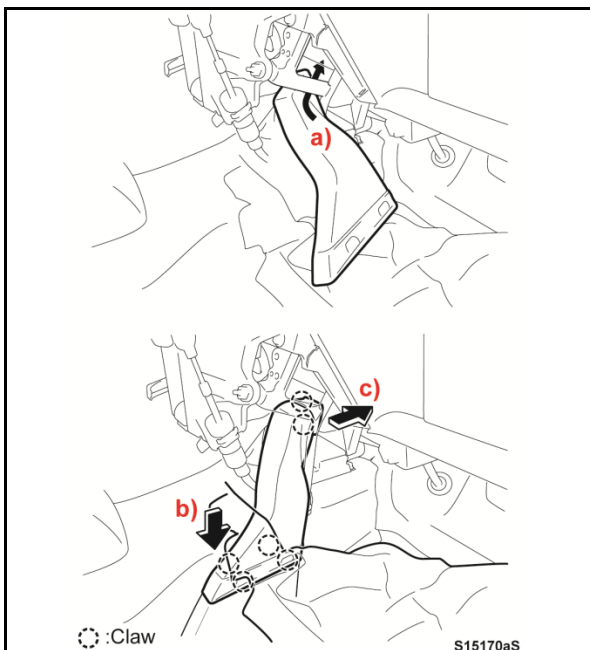

- a) Insert the upper portion of the duct inside the bracket.
- b) Engage the 4 claws on the lower portion of the duct.
- c) Engage the 2 claws on the upper portion of the duct.

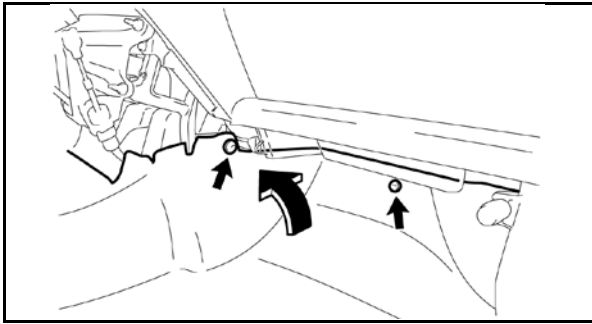

## 16. REINSTALL THE FLOOR CARPET RH

- a) Reposition the carpet and engage the 2 clips



**Confirm the floor carpet is secure and the clip is not damaged. Failure to secure the carpet could result in pedal interference.**

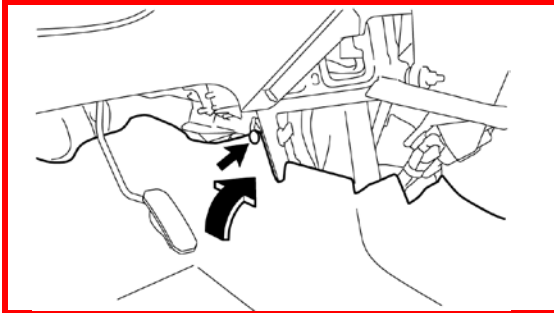

## 17. REINSTALL THE FLOOR CARPET LH

- a) Reposition the carpet and engage the clip.
- b) Fasten the Velcro fastener.

## 18. INSTALL THE FOLLOWING

- a) Instrument panel finish panel lower center.
- b) Instrument panel box.
- c) Instrument cluster finish panel No. 1.
- d) Heater control knob.
- e) Shift lever knob sub-assembly (*manual trans only*).
- f) Instrument cluster finish panel sub-assembly center.

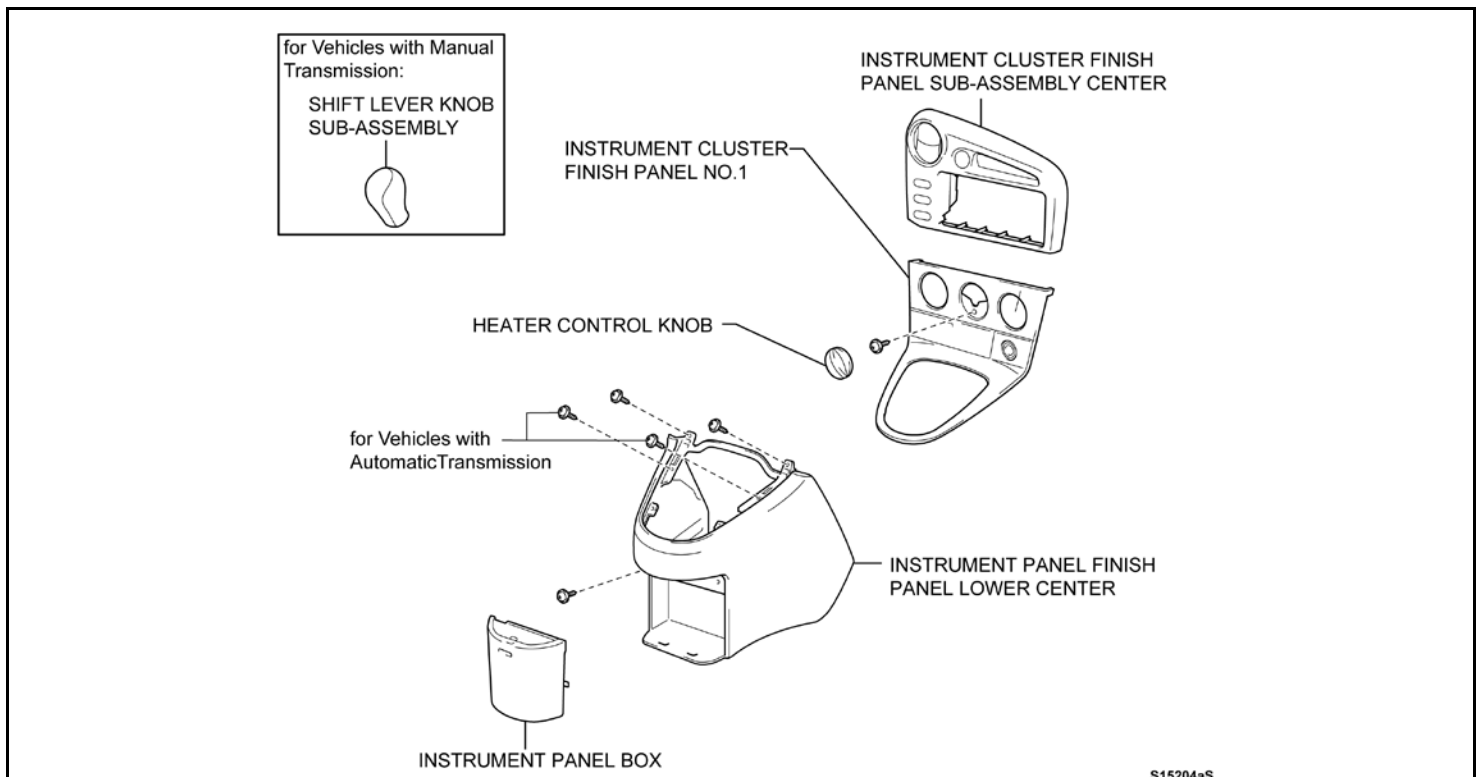

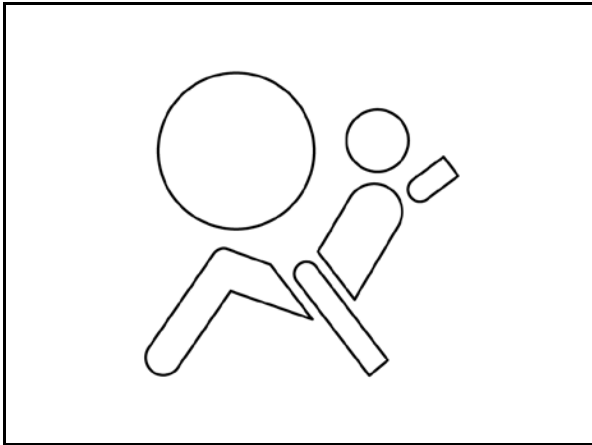

**19. RECONNECT THE NEGATIVE BATTERY TERMINAL**

**20. CHECK THE AIRBAG WARNING INDICATOR**

- a) Check that the warning indicator illuminates when the ignition is switched on.
- b) Confirm that the warning light will go off after about 6 seconds have elapsed after IG on.



- After the 6 second illumination of the warning indicator, if the indicator goes off then back on or remains on, check for DTCs.
- Consult with the customer to determine if they would like to diagnose/repair any remaining concerns.

**21. RESTORE VEHICLE SETTINGS**

- a) Restore any memory settings.
- b) Return the seats to their original positions.

**◀ VERIFY REPAIR QUALITY ▶**

- Confirm any DTCs prior to beginning this repair
  - Read all precautions as outlined on TIS before servicing the SRS system
  - Confirm ALL harness connectors are connected securely
  - Confirm the water guard sheet is secured and positioned correctly
  - Confirm the sub harness is secured correctly on top of the airbag sensor
  - Confirm there are no DTCs when the repair is complete
- If you have any questions regarding this update, please contact your area representative.

**VII. APPENDIX**

**A. CAMPAIGN DESIGNATION DECODER**

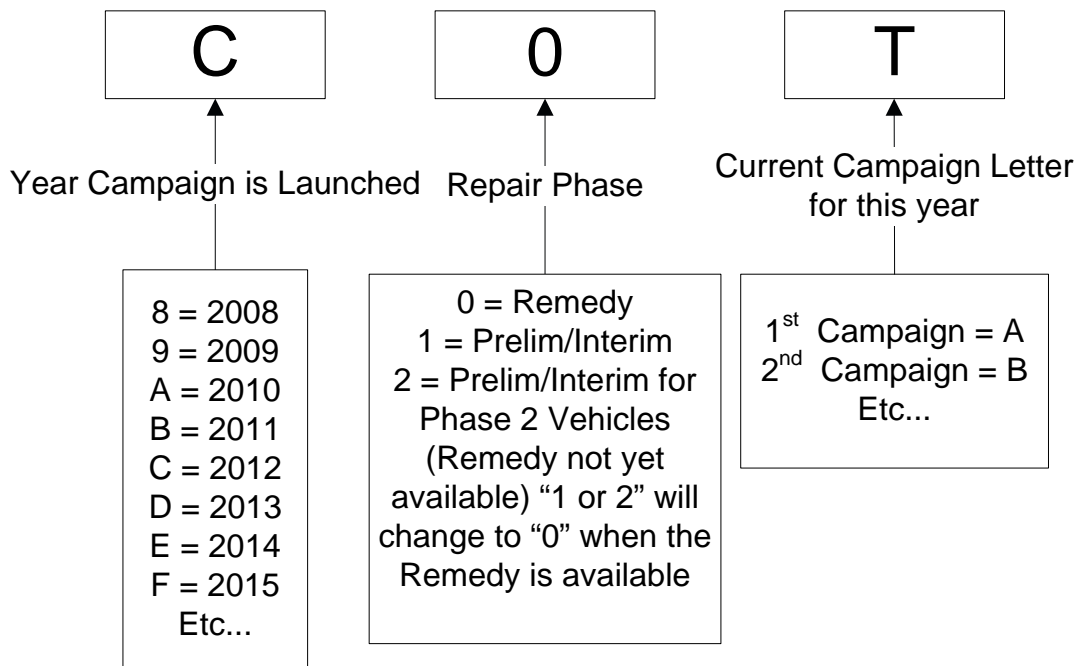

**B. CAMPAIGN PARTS DISPOSAL**

As required by Federal Regulations, please make sure all campaign parts (original parts) removed from the vehicle are disposed of in a manner in which they will not be reused, ***unless requested for parts recovery return.***