

TMS-NTC-12139
June 18, 2012

Recall Management Division
National Highway Traffic Safety Administration
1200 New Jersey Avenue, SE
Washington, DC 20590

Re: Toyota Safety Recall 11V-342 – Updated Remedy Instructions

To whom it may concern,

Please find attached updated Remedy Instructions for Toyota Safety Recall 11V-342 on the following Toyota and Lexus vehicles:

Certain 2006 and 2007 Model Year Highlander Hybrid
Certain 2006 and 2007 Model Year RX400h

If you have any questions regarding this matter, please contact me at (310) 468-3392.

Sincerely,

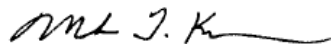

Mark Kubota
Quality Compliance Assistant Manager

Attachments:

- Lexus 11V-342 (BLD) Updated Remedy Instructions
- Toyota 11V-342 (B0J) Updated Remedy Instructions

TECHNICAL INSTRUCTIONS
FOR
SAFETY RECALL B0J
INTELLIGENT POWER MODULE TRANSISTOR REPLACEMENT
CERTAIN 2006 – 2007 MODEL YEAR HIGHLANDER HYBRID

UPDATED JUNE 14, 2012

TECHNICAL INSTRUCTION UPDATE NOTICE:

Updated 6/14/12

- Additional part number and serial number information has been added ([SECTION VI, STEP 2](#))

Updated 3/28/12

- Grease expiration date explanation has been provided ([SECTION III](#)) ([SECTION VIII, STEP B 4](#))
- Part Number and Serial Number inspection process and lookup website have been updated ([SECTION VI, STEP 2](#))

Updated 2/8/12

- Air conditioning harness sub-assembly bolt installation has been updated ([SECTION IX, STEP A 15](#))
- Combined training video link has been added

Updated 12/21/11

- Part number and Serial number inspection has been updated ([SECTION VI](#))

Previous versions of these Technical Instructions should be discarded.

[Combined B0J Training Video](#)

In order to perform this campaign, technician must be Hybrid Certified. If you have questions regarding certification, contact your area representative.

I. OPERATION FLOW CHART

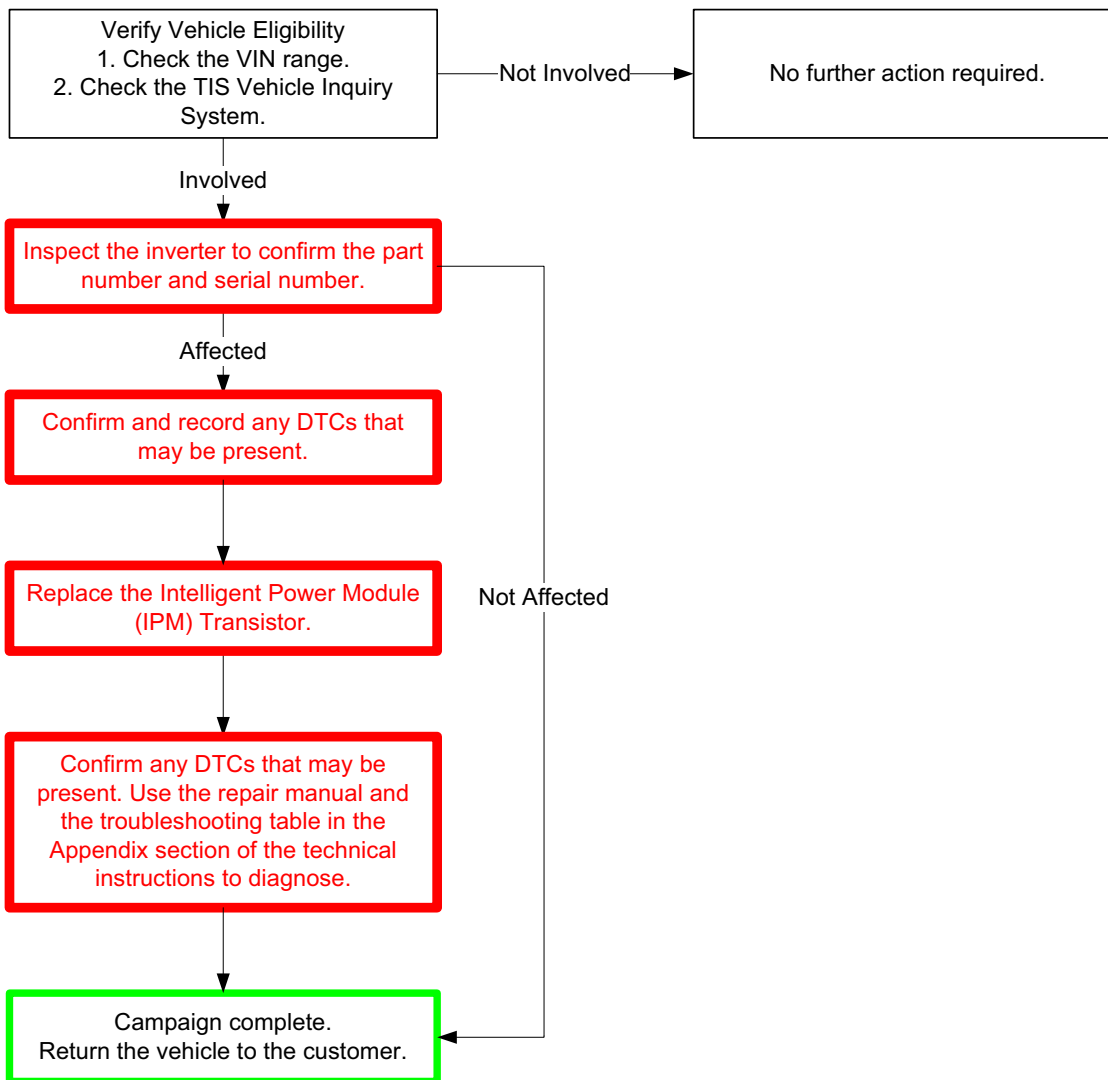

II. IDENTIFICATION OF COVERED VEHICLES

A. COVERED VIN RANGE

Model	WMI	Year	VIN Range	
			VDS	Range
HIGHLANDER HV	JTE	2006	DW21A	0001003 - 0016484
			EW21A	0001009 - 0033953
			GW21A	0001541 - 0013007
			HW21A	0001275 - 0020710
		2007	DW21A	0016485 - 0017412
			EW21A	0033956 - 0034655
			GW21A	0016486 - 0017411
			HW21A	0033954 - 0034654

NOTE:

- Check the TIS Vehicle Inquiry System to confirm the VIN is involved in this Safety Recall, and that the campaign has not already been completed prior to dealer shipment or by another dealer.
- TMS warranty will not reimburse dealers for repairs conducted on vehicles that are not covered or were completed by another dealer.

III. PREPARATION

A. PARTS





Required Parts – Necessary to complete the repair

Part Number	Part Description	Quantity
04001-29148	Intelligent Power Module Transistor	1
08887-02409	Grease G747	2

GREASE 747 EXPIRATION DATE EXPLANATION

The expiration date *DOES NOT* indicate that the grease is not useable. It is *OKAY* to use grease that is beyond the expiration date. The tube of grease must be kneaded to confirm the grease is properly mixed prior to use.

Ancillary Parts – Only necessary if lost during the repair

Part Description	Part Number	Part Description	Part Number
 10mm (0.39 in)	91551-80610	 14mm (0.55 in)	90105-A0263
 12mm (0.47 in)	90105-A0096	 22mm (0.87 in)	90080-11255
 14mm (0.55 in)	91551-80614		

B. TOOLS, SUPPLIES & EQUIPMENT





- Standard hand tools
- Torque wrench
- Techstream
- Brake cleaner
- Marking pen
- Air gun
- Throttle plate cleaner 00289-1TP00 (or equivalent)
- Insulating tape
- DVOM

SST – These are essential special service tools that the dealership should have.

Part Number	Part Name	Quantity
00002-03100-S	Electrical Insulating Gloves (Small)	1
00002-03200-M	Electrical Insulating Gloves (Medium)	
00002-03300-L	Electrical Insulating Gloves (Large)	

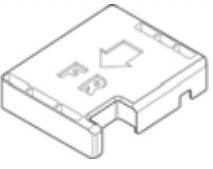
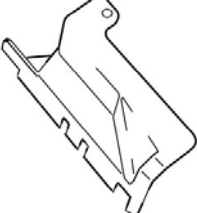
NOTE: If additional gloves are needed they can be ordered through SPX by calling 800-933-8335

Campaign Tools – These tools are provided to the dealership.

Part Name	Sample	Quantity	Part Name	Sample	Quantity
Protective Cover A		1	Protective Cover B		1
Masking Plate		1	Squeegee		1
Stud Bolt		2	Masking Plate Nut/Bolt		4

IV. BACKGROUND

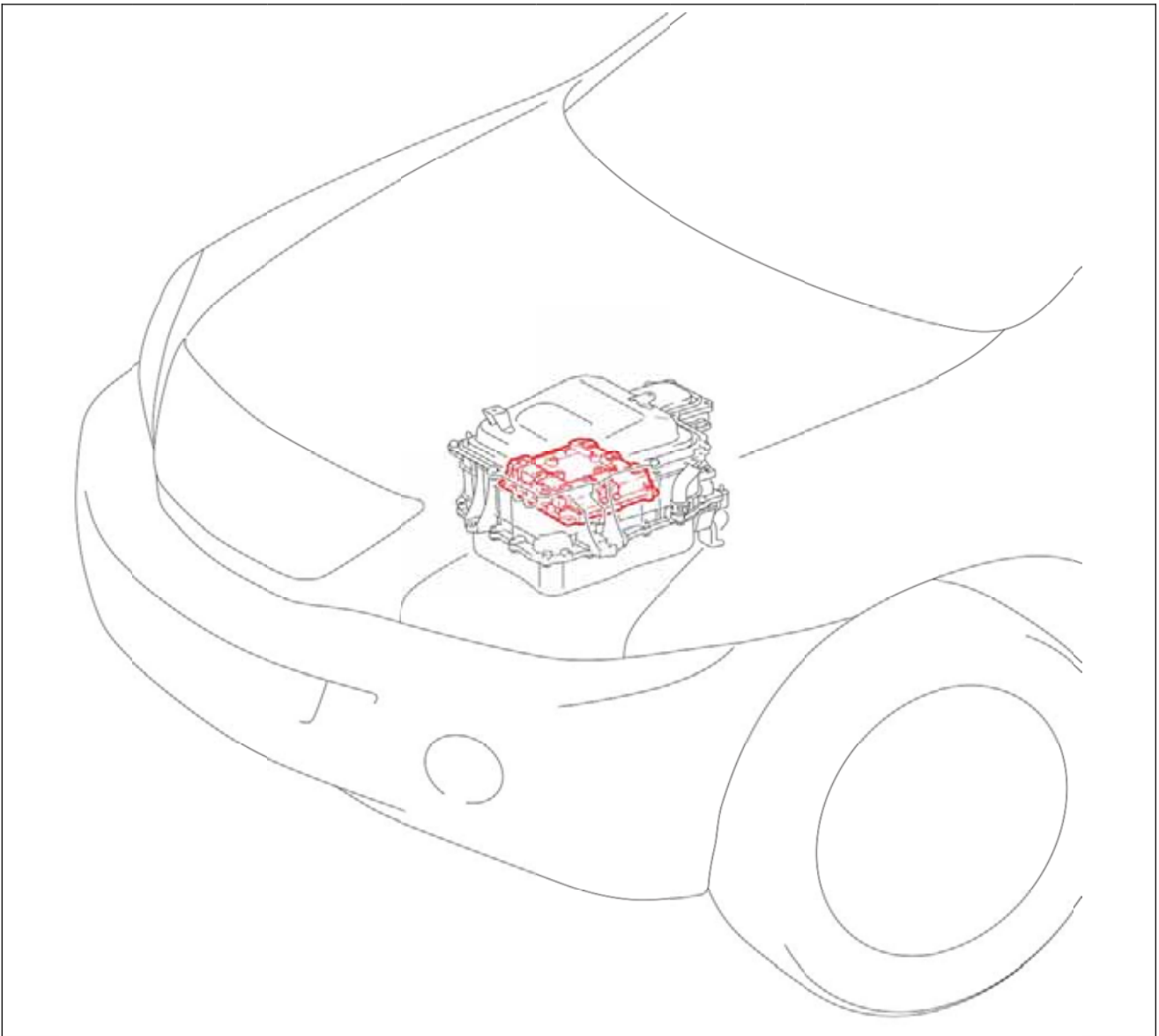

The Intelligent Power Module (IPM) is located inside the Hybrid System Inverter and contains a control board with transistors. Certain transistors on the control boards of some of the subject vehicles were inadequately soldered and could be damaged from heat caused by a large current during high-load driving. If this occurs, various warning lamps will be illuminated on the instrument panel. The vehicle may enter a fail-safe/limp-home mode that limits the driving speed of the vehicle. It is possible that the hybrid system will shut down while the vehicle is being driven, causing the vehicle to stall unexpectedly, increasing the risk of a crash.

V. SAFETY PRECAUTIONS

A. SAFETY CHECKLIST & PRECAUTIONS WHEN WORKING ON THE HIGH VOLTAGE SYSTEM



- Always remember **"SAFETY FIRST"**
- Be extremely careful when handling high voltage components
- Before beginning and while working on the high voltage system, perform the following safety check list.

1. AIR VENTILATION AND FOREIGN MATERIALS

- Perform work in an area that is free of dust and other airborne matter.
- Do not perform the work next to a stall where grinding or spraying of chemicals is performed.
- When not working in the inverter, temporarily install the inverter cover to prevent foreign material entering the inverter.

2. PREVENT STATIC ELECTRICITY

- Static electricity can have an adverse effect on inverter components, discharge static electricity by touching a ground location on the vehicle before starting work.

3. PREVENT ELECTRICAL SHOCKS & SHORTS

- Confirm the auxiliary battery and the service grip have been unplugged for at least 5 minutes before beginning work on the high voltage system.
- Store the service grip in a secure location (in your pocket) to prevent accidental installation.
- To prevent short-circuiting of components, wrap tools with insulating tape before use.
- Do not wear metal; watches, rings, mechanical pencils, etc...
- When working with or around a high voltage circuit (orange connectors and cables) wear the correct electrical insulating gloves.
- Confirm your electrical insulating gloves are not wet, or dirty.
- Confirm your electrical insulating gloves are not punctured or torn.

4. USE OF AIR & POWER TOOLS

- Do not use air tools or power tools on any component once the inverter cover has been removed to prevent damage and foreign materials from entering the inverter.

5. HANDLING OF PARTS

- Keep all removed parts organized and clean.
- Store all removed parts so they are not contaminated or damaged when removed from the inverter.

6. HANDLING OF THE INVERTER & CONNECTORS

- Cover all high voltage connectors with insulating tape immediately after disconnecting the connector.
- Use extreme care to prevent nuts/bolts from falling into the inverter when work is performed. If a part falls into the bottom section of the inverter the entire inverter assembly may need to be removed.
- Use extreme care to not drop any tools in the inverter assembly.

7. CONNECTING HIGH VOLTAGE TERMINALS

- Confirm all terminals are clean before connecting to the inverter.
- Torque specifications are critical, confirm all bolts are torque as described in these instructions.

8. INTERMEDIATE INSPECTIONS

- Perform all intermediate inspections to prevent errors.

9. ASSIGN A SAFETY SUPERVISOR

- Assign a safety supervisor to be in charge of all safety precautions in the work area.
- Put a "Working with high voltage" warning sign on the vehicle during work.

Person in charge: _____
high voltage system
Working on
CAUTION:

CAUTION:
Working on
high voltage system
Person in charge: _____

Fold this page and place on the roof of vehicle.

VI. INVERTER VERIFICATION

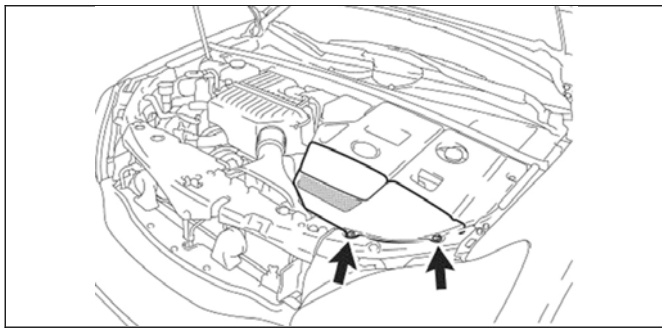

1. REMOVE THE ENGINE ROOM SIDE LH COVER
 - a) Remove the 2 clips and the engine room cover.

[Click here to watch the video introduction](#)

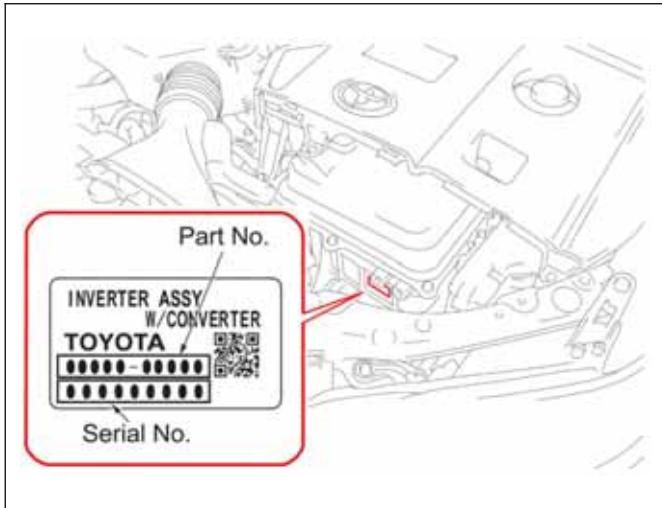

2. CONFIRM THE **PART NUMBER** and **SERIAL NUMBER**

- a) Record the part number and serial number on the repair order.
- b) Use the following website to determine if intelligent power module (IPM) transistor replacement is necessary.

<http://b0j-bld-lookup.imagespm.info>

NOTE:

- If the part number or serial number cannot be determined, the IPM transistor should be replaced.
- If there are any concerns regarding this inspection, email a picture of the label to quality_compliance@toyota.com for assistance.

PART & SERIAL NUMBER INFORMATION

Use this information when interpreting the inverter part & serial numbers. If the part or serial number on the inverter is misinterpreted the appropriate repair may not be applied to the vehicle.

Part Number	Serial Number
<p>ALWAYS a Letter</p> <p>Letter or Number</p> <p>G9200-48021</p> <p>ALWAYS Numbers</p> <p>ALWAYS 10 Digits</p>	<p>ALWAYS Letters</p> <p>PA12WM058</p> <p>ALWAYS Numbers</p> <p>ALWAYS 9 Digits</p>
<ul style="list-style-type: none"> • The part number is ALWAYS 10 digits long. If ALL 10 digits cannot be determined, the IPM transistor should be replaced. • The part number will ALWAYS follow the format shown in the illustration. 	<ul style="list-style-type: none"> • The serial number is ALWAYS 9 digits long. If ALL 9 digits cannot be determined, the IPM transistor should be replaced. • The serial number will ALWAYS follow the format shown in the illustration.

Letter and number samples:

- Pay close attention to the differences in the letters I and L and the number 1.
- Pay close attention to the differences in the letter O and number 0.
- Pay close attention to the differences in the letter G and the number 6.

Letters: A, B, C, D, E, F, G, H, I, J, K, L, M, N, O, P, Q, R, S, T, U, V, W, X, Y, Z

Numbers: 0, 1, 2, 3, 4, 5, 6, 7, 8, 9

VII. DISASSEMBLY

A. COMPONENTS

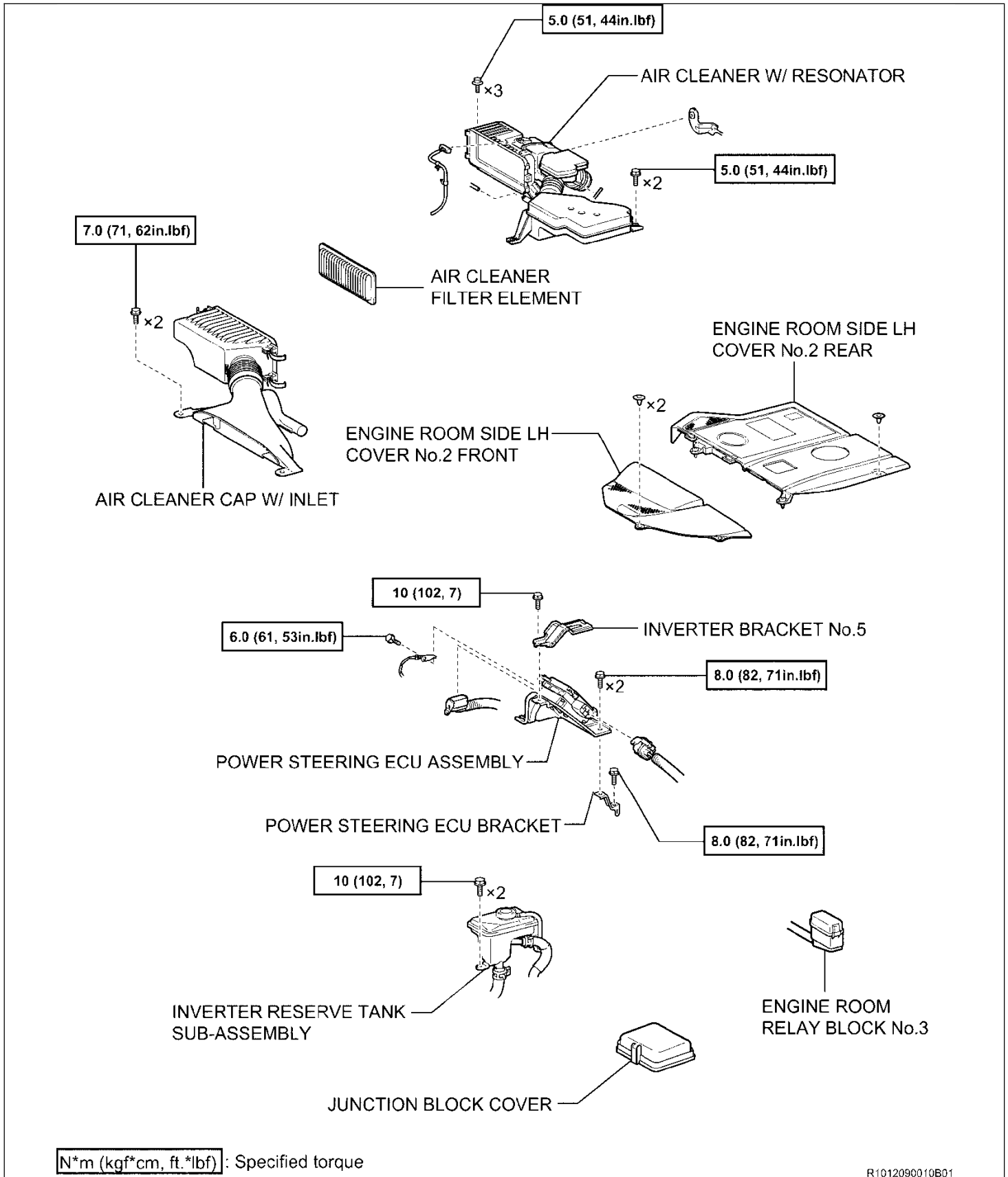

**TORQUE SPECIFICATIONS INSIDE THE INVERTER ARE CRITICAL
CONFIRM ALL BOLTS ARE TORQUED AS OUTLINED IN THESE INSTRUCTIONS**

**INTERNAL COMPONENTS IN THE INVERTER ARE NOT AVAILABLE AS SERVICE PARTS
BE CAREFUL WHEN REMOVING, STORING, AND REINSTALLING THESE COMPONENTS**

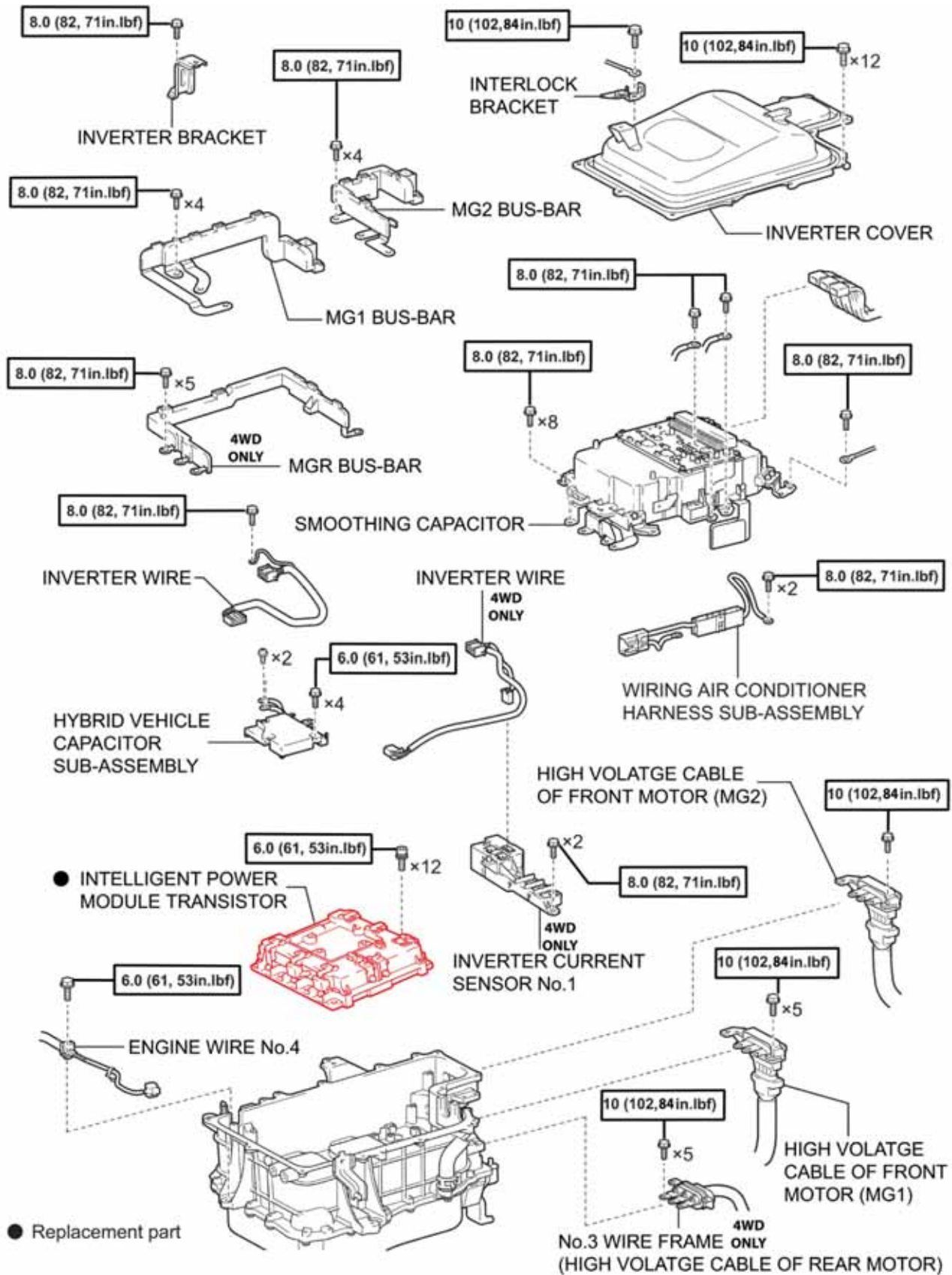

B. VEHICLE DISASSEMBLY



It is extremely important that all of the vehicle disassembly steps are followed prior to proceeding to the inverter disassembly steps. Failure to follow all steps could result in inverter damage.

1. DETERMINE THE WORK PLACE

- Choose a spot that is free of dust and debris. **DO NOT** work next to a place where grinding or spraying of chemicals is performed.



It is extremely important to prevent contamination of the inverter assembly. Confirm the work area is clean and free from airborne matter.

2. PLACE THE PROVIDED CAUTION SIGN ON THE ROOF OF THE VEHICLE

3. RECORD AUDIO AND AIR CONDITIONING SYSTEM SETTINGS

4. CHECK FOR DIAGNOSTIC TROUBLE CODES

- If any DTCs are output record the data.

5. DISCONNECT THE NEGATIVE BATTERY CABLE

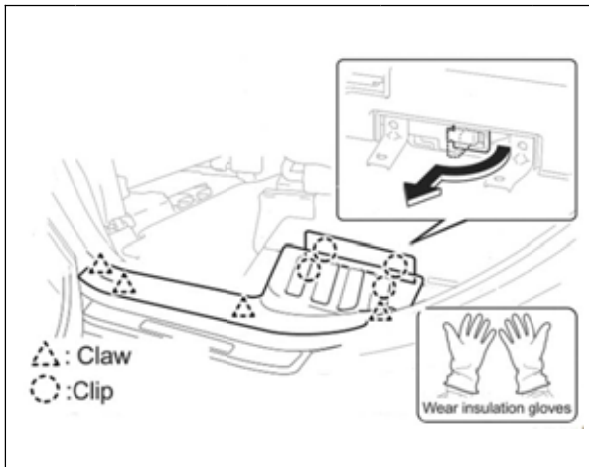

6. REMOVE THE SERVICE GRIP

- Disengage the 4 claws and 2 clips and remove the rear door scuff plate.
- Disengage the 2 clips and the service grip access cover.
- Wearing insulating gloves, remove the service grip.



- Store the service grip in a secure location (in your pocket) to prevent accidental installation.
- After removing the service grip, wait at least 5 minutes before working on the high voltage system.
- DO NOT** attempt to switch the vehicle to **READY ON** with the service grip removed.

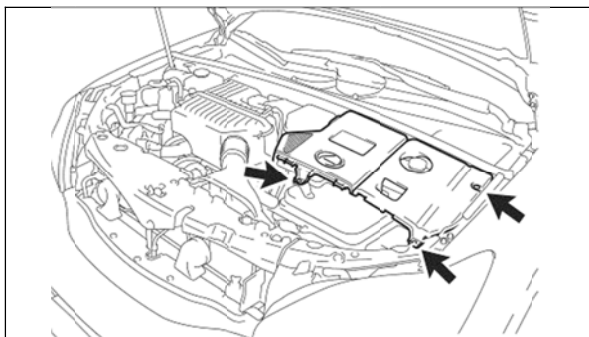

7. REMOVE THE ENGINE ROOM SIDE LH COVER No.2 REAR

- Remove the 3 clips and the cover.

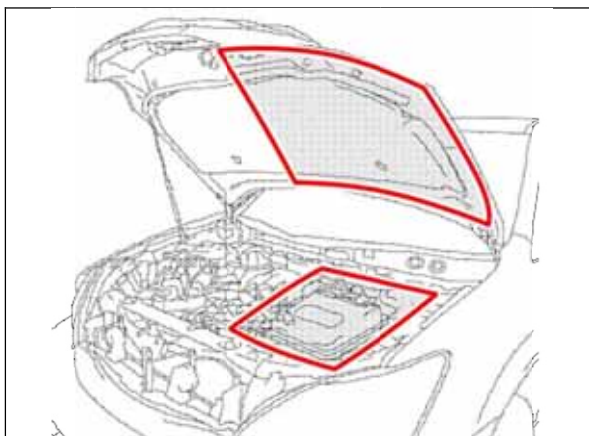

8. CLEAN THE AREA AROUND THE INVERTER

- Thoroughly remove dust and water from the areas highlighted in the illustration using shop cloths and an air gun.



The inverter is a precision component, contamination can cause a malfunction.

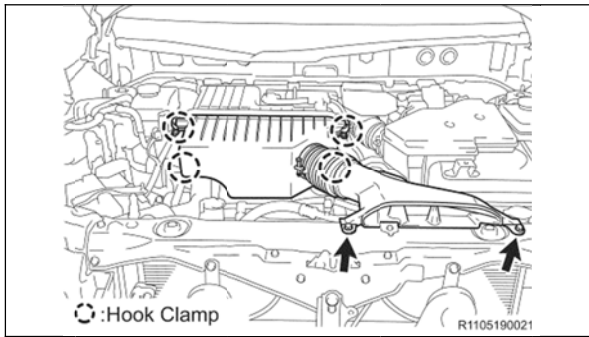

9. REMOVE THE AIR CLEANER CAP WITH INLET

- a) Remove the 2 bolts and the 4 hook clamps and the air cleaner.

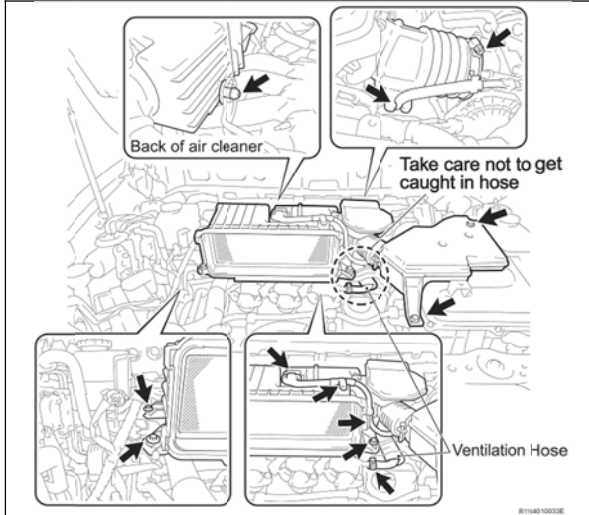

10. REMOVE THE AIR CLEANER CASE WITH RESONATOR

- a) Disconnect all hoses and connectors, disconnect the 5 bolts and the air cleaner case.

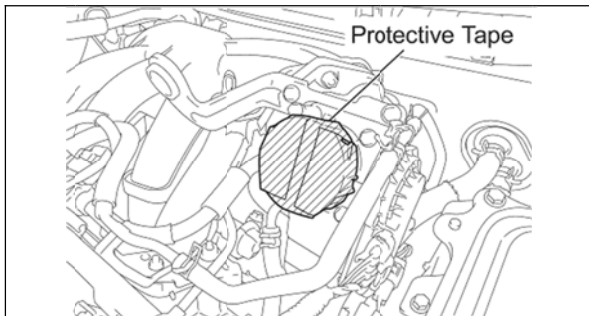

11. COVER THE THROTTLE BODY

- a) To prevent foreign material from entering the throttle body, cover with tape.

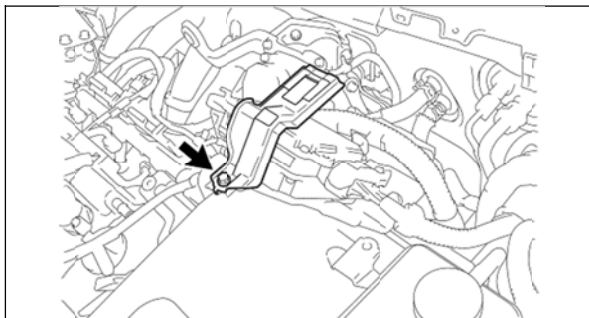

12. REMOVE THE INVERTER BRACKET No.5

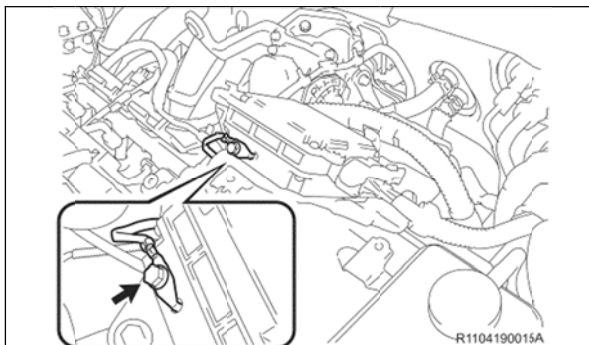

13. REMOVE THE POWER STEERING ECU ASSEMBLY



Wear insulating gloves when removing the power steering gear ECU, circuit voltage is approximately 42V.

- a) Remove the ground wire bolt and ground wire.
- b) Wrap the ground terminal with insulating tape.

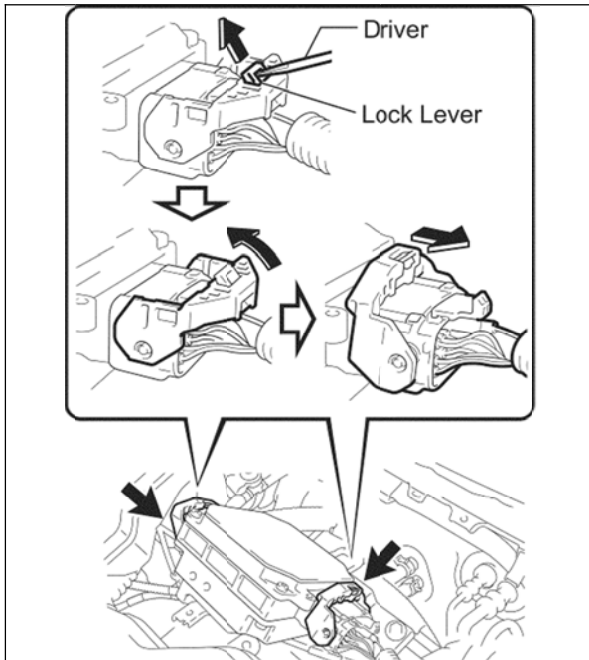

- c) Remove the 2 connectors as described in the illustration.
- d) Wrap the terminals of the connectors with insulating tape.

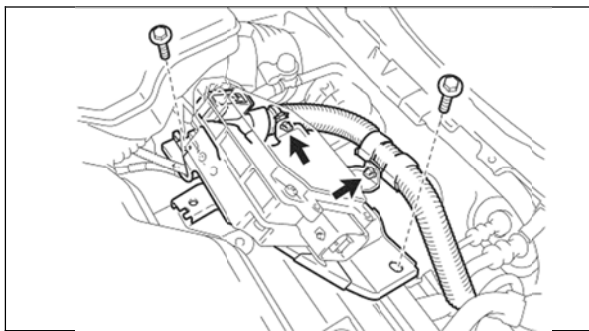

- e) Disconnect the 2 wire harness clamps.
- f) Remove the 2 bolts and the ECU.

14. REMOVE THE POWER STEERING ECU BRACKET

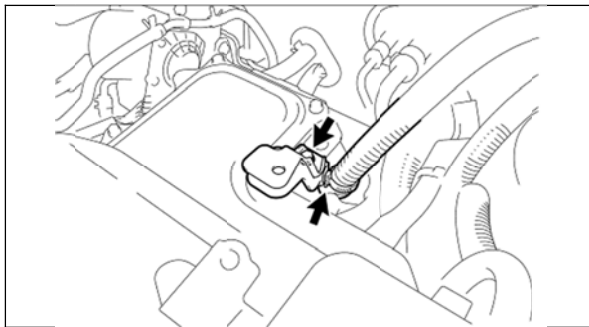

- a) Remove the bolt and bracket.

15. DISPLACE THE INVERTER RESERVE TANK SUB ASSEMBLY

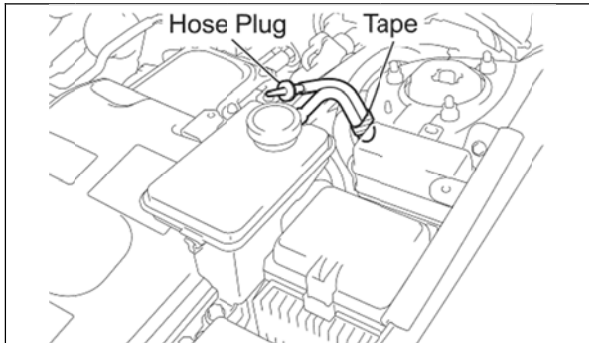

- a) Confirm the tank cap is securely tightened.
- b) Plug the overflow hose, then fix the hose with tape as illustrated to prevent coolant leakage.

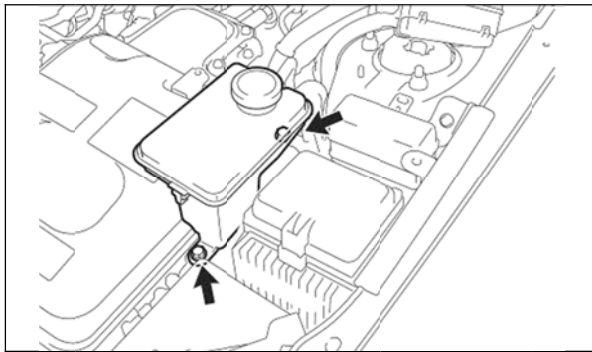

c) Remove the 2 bolts for the reserve tank.

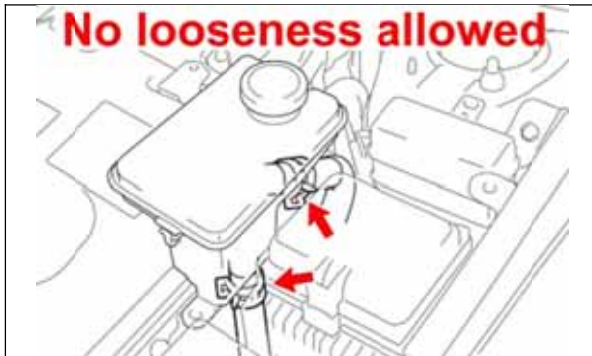

d) Confirm the 2 hoses connected to the reserve tank are secure.

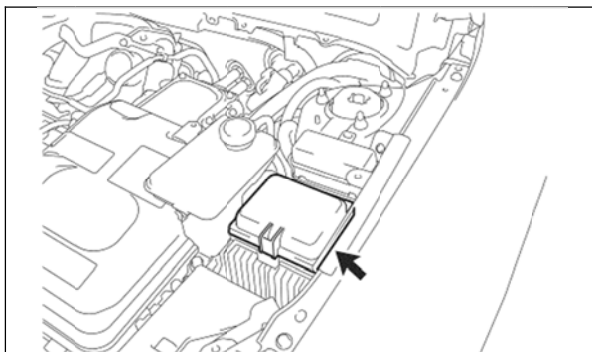

16. REMOVE THE JUNCTION BLOCK COVER

NOTE: The reserve tank cannot be displaced unless the cover is removed.

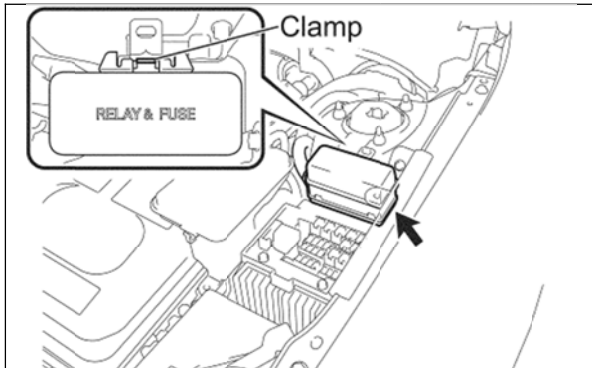

17. DISCONNECT THE ENGINE ROOM RELAY BLOCK No.3

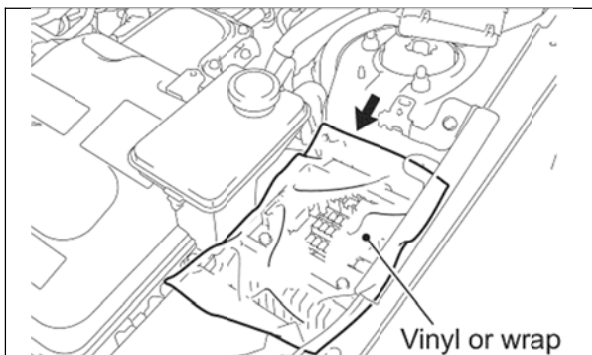

18. PROTECT THE JUNCTION BLOCK

a) Cover the exposed fuses and relays with a waterproof material.

NOTE: *DO NOT* use tape to cover the junction block as relays and fuses may be pulled out when the tape is removed.

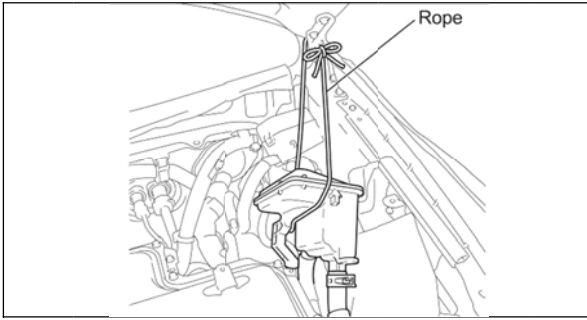

19. DISPLACE THE INVERTER RESERVE TANK SUB ASSEMBLY

- a) Displace the reserve tank and secure it to the hood hinge to gain access to the inverter cover.
- b) Confirm the reserve tank does not leak coolant when in the displaced position.

NOTE: DO NOT put excessive strain on the reserve tank hoses.

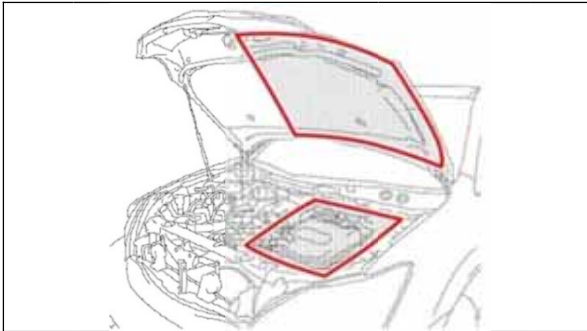

20. CLEAN THE AREA AROUND THE INVERTER

- a) Confirm all dust and water has been removed from the areas highlighted in the illustration. Clean using shop cloths and an air gun.



The inverter is a precision component and any contamination may cause a malfunction.

THE FOLLOWING CONFIRMATION STEPS ARE VITAL CONFIRM THESE STEPS ARE FOLLOWED CLOSELY

PERFORM THIS INTERMEDIATE INSPECTION BEFORE BEGINNING WORK ON THE INVERTER.

1. Is the work space clear of dust and water?
2. Is the "Working with high voltage" warning sign posted?
3. Is the auxiliary battery disconnected and the service grip in a secure location (in your pocket)?
4. Is the inverter reserve tank displaced securely and free of leaks?
5. Are the areas around the inverter and the underside of the hood properly cleaned?
6. Are you wearing electrical insulating gloves that are in good condition?
7. Is the protective cover A clean and available for use?
8. Have you discharged all potential static electricity from your person?

C. INVERTER DISASSEMBLY



- It is extremely important to prevent contamination of the inverter assembly.
- Confirm the work area is clean and free from airborne matter.
- Be sure to wear electrical insulating gloves during the entire inverter disassembly procedure.
- **DO NOT** use any air tools or power tools during the inverter disassembly procedure.
- Confirm all tools used on HV components are insulated or wrapped with insulating tape.
- Internal components in the inverter are not available as service parts, be careful when removing, storing, and reinstalling these components.

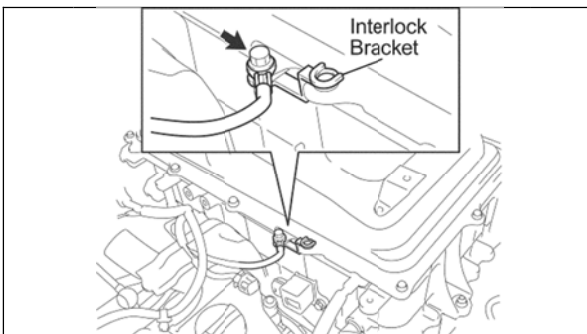

1. REMOVE THE INVERTER COVER

- a) Remove the bolt and the interlock bracket.
- b) Wrap the terminal with insulating tape.



Confirm the entire cowl assembly has been removed prior to removing the inverter cover. Failure to do so could result in damage in the inverter.

[Click here to watch the video supplement for steps 1-8](#)

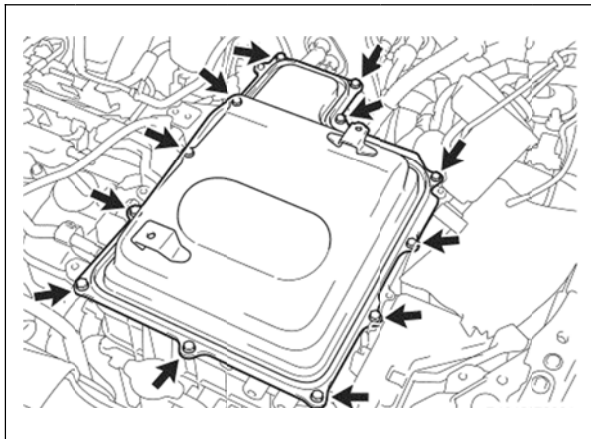

c) Loosen the 12 bolts evenly in 2 increments to remove the cover.

NOTE:

- **DO NOT** deform the cover during removal.
- To prevent damage to the insulating gloves, wear work gloves over the insulating gloves.



- Take extra precautions to prevent foreign material from entering the inverter.
- **DO NOT** touch the circuit board inside the inverter.

d) Store the inverter cover in a safe location to prevent damage to the inverter cover gasket.

2. PERFORM A FINAL VOLTAGE CHECK

a) Measure the voltage at the points indicated in the illustration.

Standard Voltage: 0V

NOTE: If voltage is present, confirm all previous steps to disable the high voltage system have been followed.

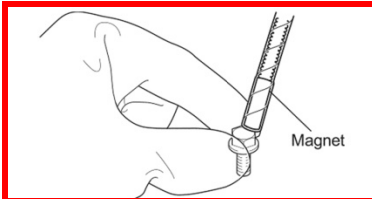
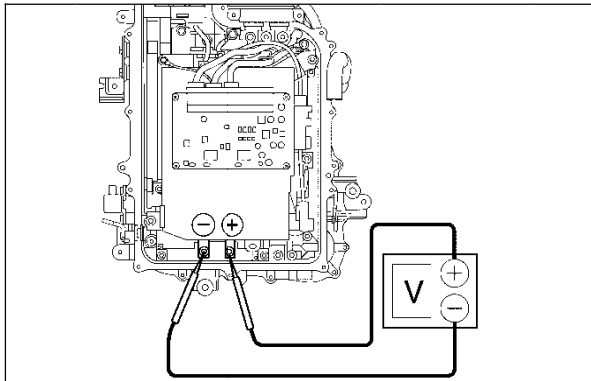

NOTE:

- To prevent dropping any bolts into the inverter it may be necessary to use a magnet to pick up bolts as they are loosened.
- If bolts are dropped into the bottom section of the inverter it may be necessary to completely remove the inverter for retrieval.

3. DISCONNECT THE MG ECU CONNECTORS

a) Remove the ground bolt.

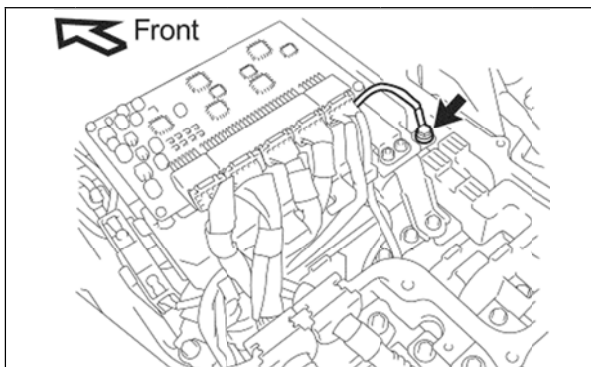

b) Disconnect the 2 connectors and the 2 grommets.

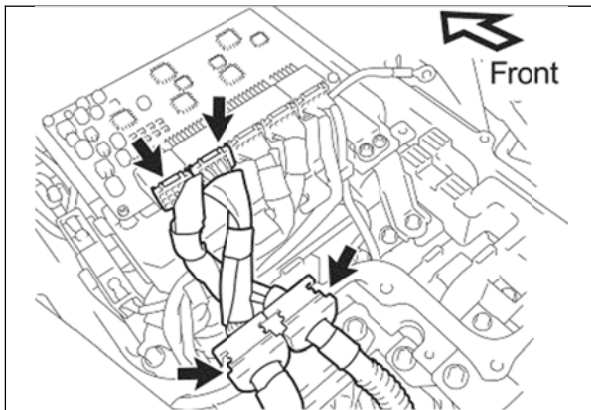

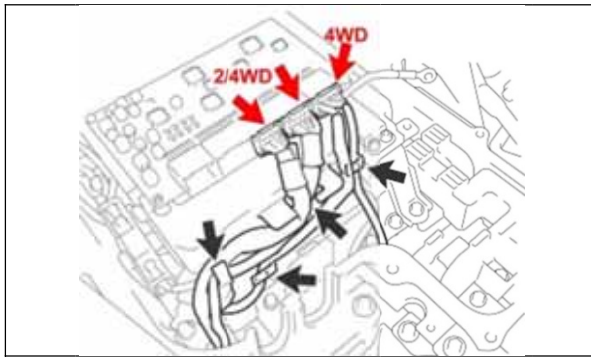

- c) **4WD** – Disconnect the 3 connectors and remove the wires from the clamps.
2WD – Disconnect the 2 connectors and remove the wires from the clamps.

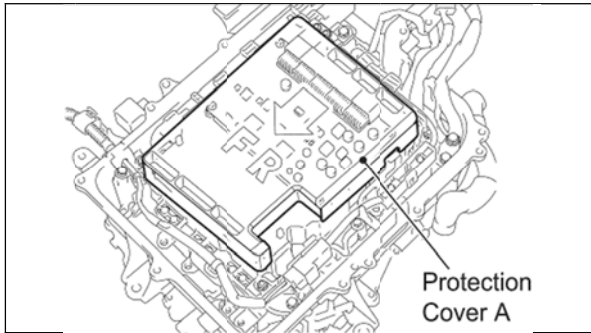

4. INSTALL PROTECTIVE COVER A

- a) Immediately install the cover to protect the circuit board from damage and contamination.

NOTE: Use caution when installing the cover to avoid damaging the MG ECU.

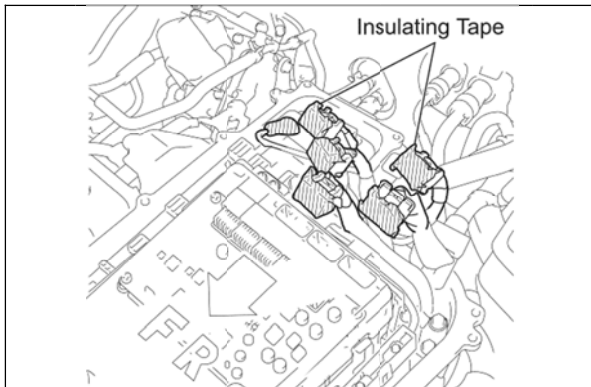

5. PROTECT THE CONNECTORS AND HARNESS

- a) Cover the disconnected connectors and terminal with insulating tape.
b) Bundle the harness and secure it away from the inverter.

NOTE: Confirm the harness is positioned so the sharp edge of the inverter case does not cut the wires.

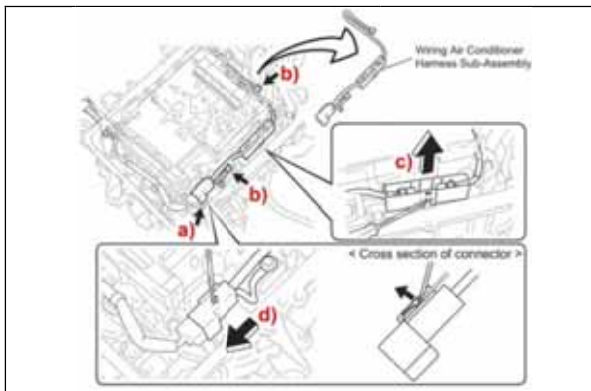

6. REMOVE THE AIR CONDITIONER HARNESS SUB ASSEMBLY

- a) Disconnect the connector.
b) Remove the 2 ground bolts.
c) Raise the tab of the fuse box to remove it from the bracket.
d) Raise the tab of the connector to remove it from the bracket.

STOP DO NOT remove the harness until all connectors have been disconnected to prevent damaging components.

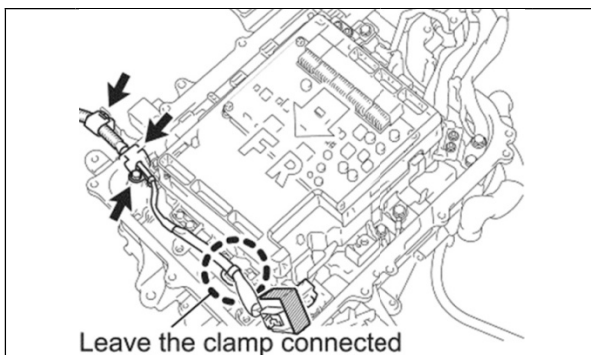

7. DISCONNECT THE ENGINE WIRE No.4

- a) Cover the connector with insulating tape.
b) Remove the bolt.
c) Disconnect the grommet.
d) Disconnect the harness clamp located **outside** the inverter.

NOTE: DO NOT disconnect the harness clamp located inside the inverter at this time to avoid damaging the clamp or the smoothing capacitor.

Leave the clamp connected

8. REMOVE THE SMOOTHING CAPACITOR

- a) **4WD** – Remove the 11 bolts.
2WD – Remove the 9 bolts.

- b) Cover the terminals with insulating tape.

NOTE: Confirm protective cover A is fully installed.

- c) Lift the smoothing capacitor.

- d) Disconnect the wire harness clamp.

- e) Remove the smoothing capacitor.

NOTE:

- **DO NOT** bend the insulation bracket.
- **Handle the smoothing capacitor carefully.**

- f) Store the smoothing capacitor with protective cover A down.

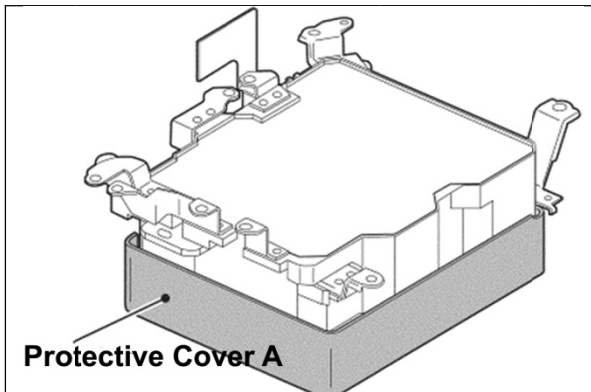
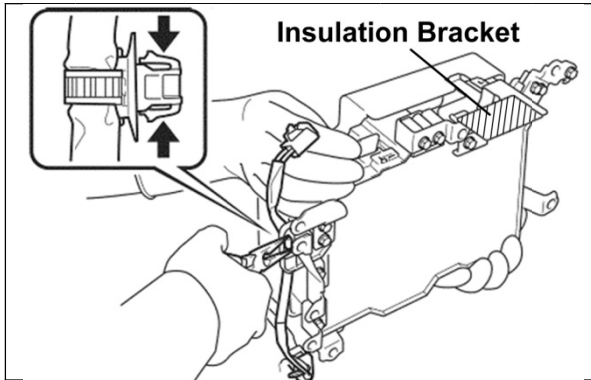
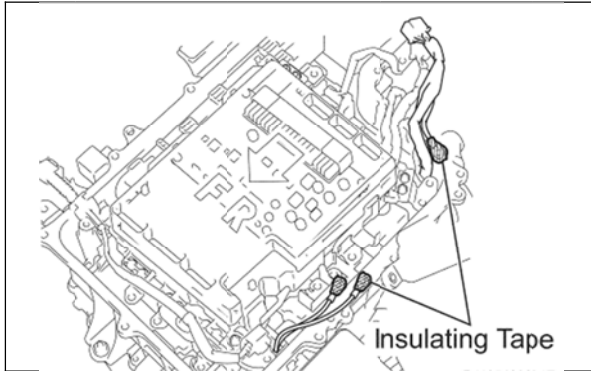
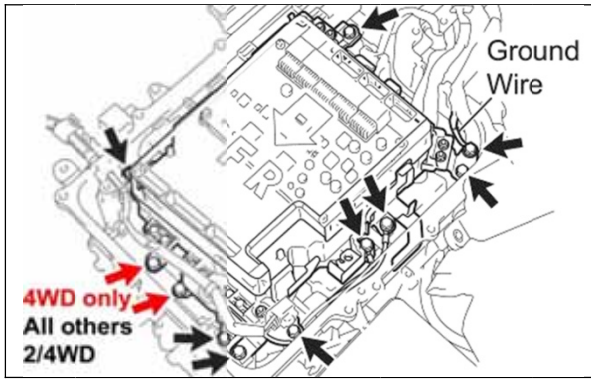

NOTE:

- **DO NOT** store the smoothing capacitor with protective cover A facing up.
- **DO NOT** cover the smoothing capacitor with a shop cloth to avoid damaging the insulation bracket.
- **Store the smoothing capacitor in a location that is free of dust and other airborne matter.**

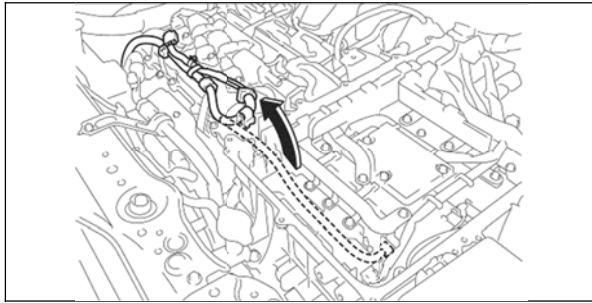

9. PROTECT THE HARNESES AND TERMINALS

- a) Position the disconnected harness outside the inverter so it does not obstruct the work.

[Click here to watch the video supplement for steps 9-20](#)

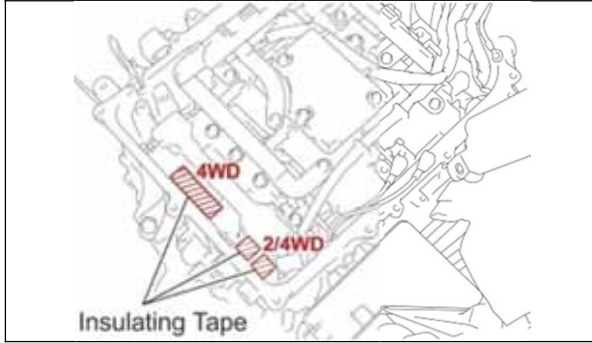

- b) Cover the terminals indicated in the illustration with insulating tape.

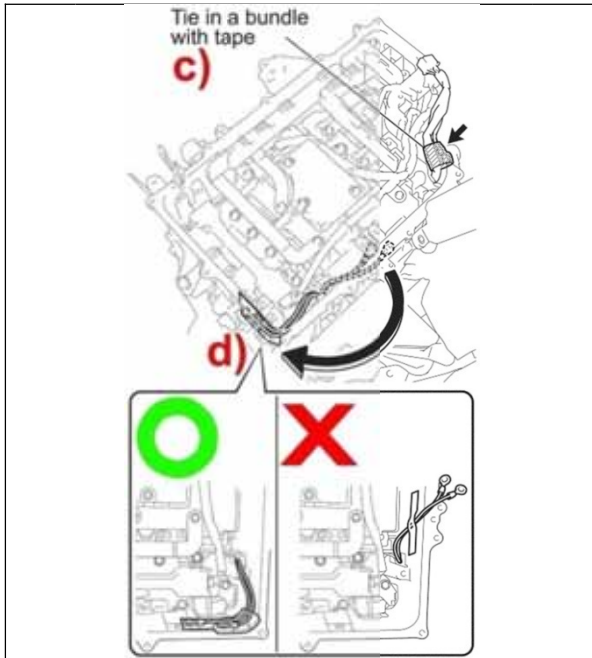

- c) Secure the terminal to the other harnesses at the rear of the inverter so it does not obstruct the work.
- d) Secure the 2 forward terminals to the inner wall of the inverter as indicated in the illustration so they do not obstruct the work.

NOTE: DO NOT position the terminals in a way that will allow the inverter cover to pinch them when the cover is temporarily installed.

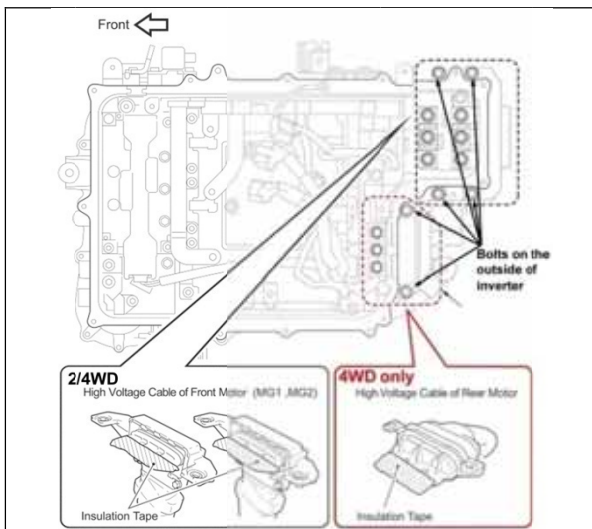

10. DISCONNECT THE HIGH VOLTAGE CABLES

- a) **4WD** – Remove the 15 bolts and disconnect the high voltage MG1, MG2, and MGR cables. Cover the terminals with insulating tape.
2WD – Remove the 10 bolts and disconnect the high voltage MG1 and MG2 cables. Cover the terminals with insulating tape.



To prevent contamination, DO NOT use the bolts that were removed from the outside of the inverter on the inside.

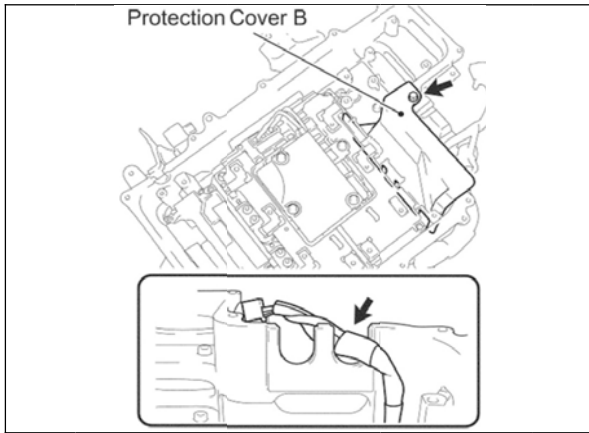

11. 2WD ONLY – INSTALL PROTECTIVE COVER B

- a) Position the wire harness in the groove of the inverter case.
- b) Install protective cover B using an inverter cover bolt.

NOTE:

- Tighten the bolt by hand **ONLY**.
- Protective Cover B will be installed on 4WD vehicles at step 18.

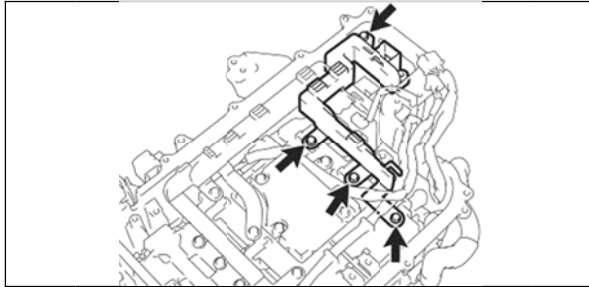

12. REMOVE THE MG2 BUS BAR

- a) Remove the 4 bolts and the bus bar.

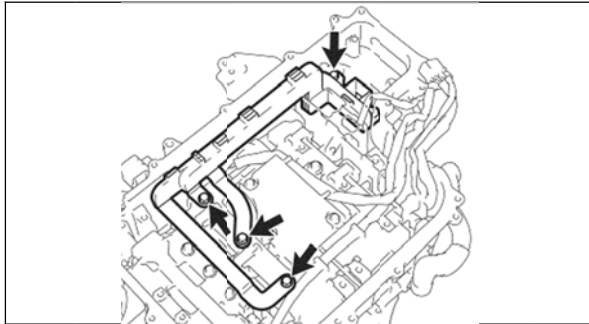

13. REMOVE THE MG1 BUS BAR

- a) Remove the 4 bolts and the bus bar.

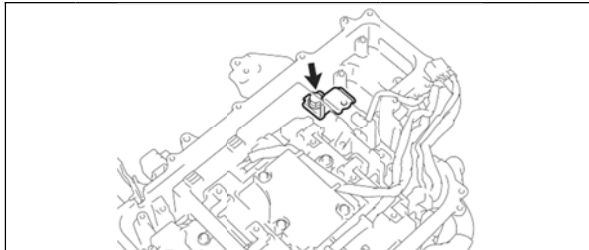

14. 4WD ONLY – REMOVE THE INVERTER BRACKET

- a) Remove the bolt and the bracket.

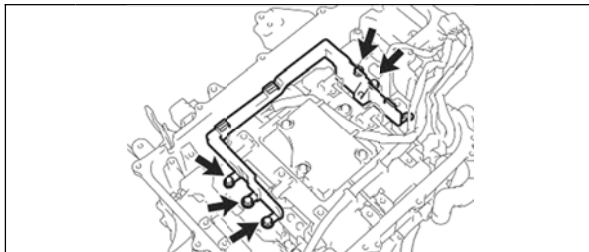

15. 4WD ONLY – REMOVE THE MGR BUS BAR

- a) Remove the 5 bolts and the bus bar.

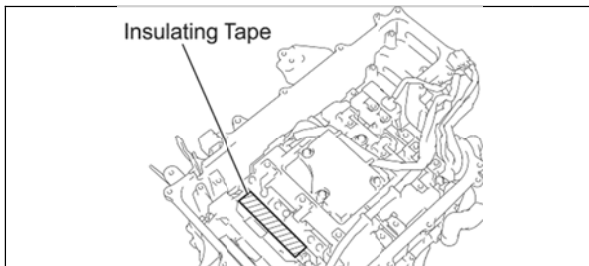

- b) Cover the terminals indicated in the illustration with insulating tape.



16. 4WD ONLY – REMOVE THE INVERTER CURRENT SENSOR No.1

- a) Disconnect the connector.
- b) Remove the 2 bolts and the sensor.

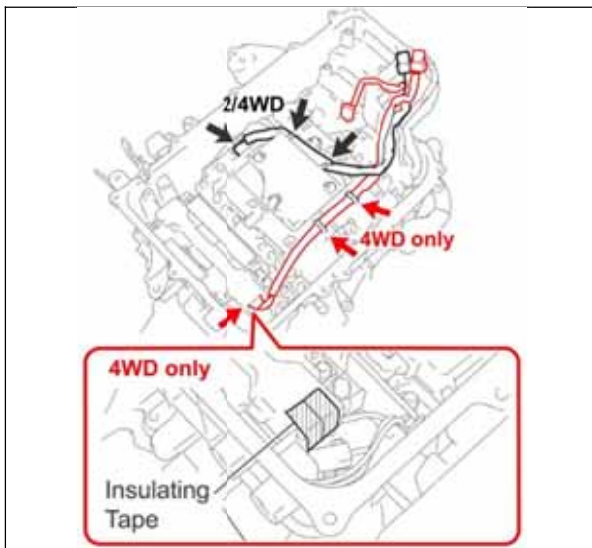

17. REMOVE THE INVERTER WIRE HARNESSSES

- a) **4WD ONLY** – Disconnect the 2 clamps and the connector and remove the harness. Attach insulating tape to the connector indicated in the illustration.
- 2/4WD** – Disconnect the 2 clamps and the connector and remove the harness.

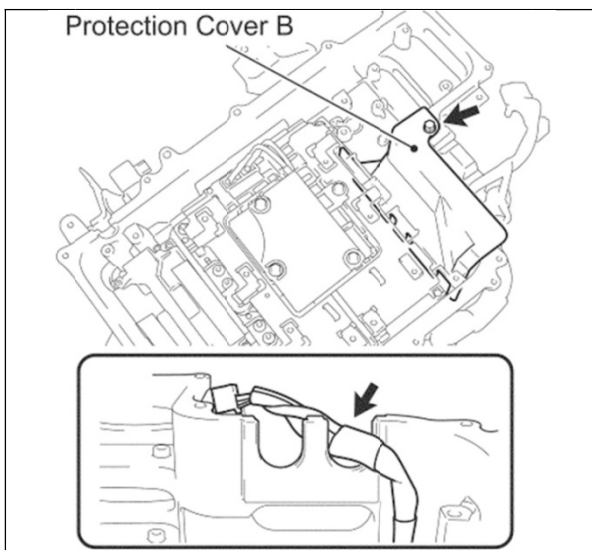

18. INSTALL PROTECTIVE COVER B

- a) Position the wire harness in the groove of the inverter case.
 - b) Install protective cover B using an inverter cover bolt.
- NOTE: Tighten the bolt by hand ONLY.**

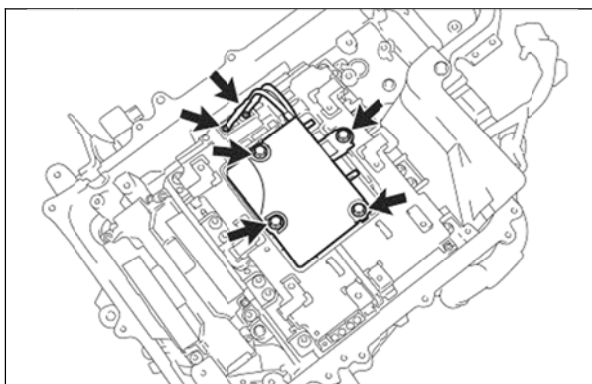

19. REMOVE THE HYBRID VEHICLE CAPACITOR SUB ASSEMBLY

- a) Remove the 2 terminal screws.
- b) Remove the 4 bolts and the capacitor.

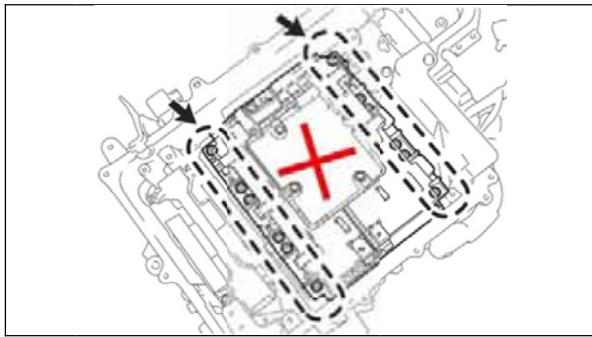

20. REMOVE THE INTELLIGENT POWER MODULE (IPM) TRANSISTOR

- a) Mark the IPM transistor so that it is not reused.
- b) Remove the 12 bolts.
- c) Lift one side of the IPM transistor to release the connection caused by the heat conductive grease.
- d) Remove the IPM transistor.

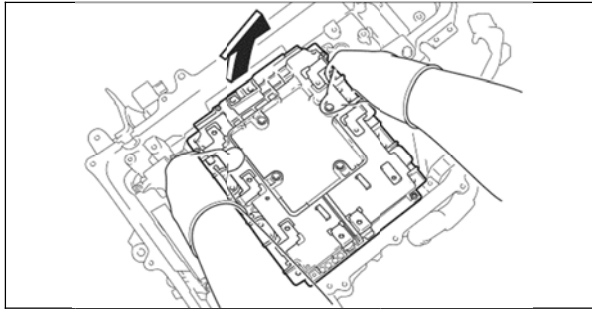

DO NOT use any pry tools when removing the IPM transistor, this may damage the inverter case.

D. INVERTER CLEANING

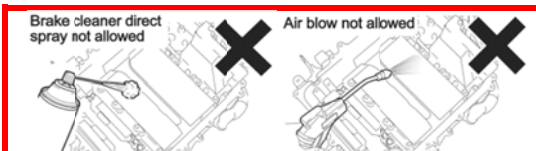

NOTE:

- **DO NOT** spray brake cleaner directly in the inverter.
- **DO NOT** use an air gun in the inverter.

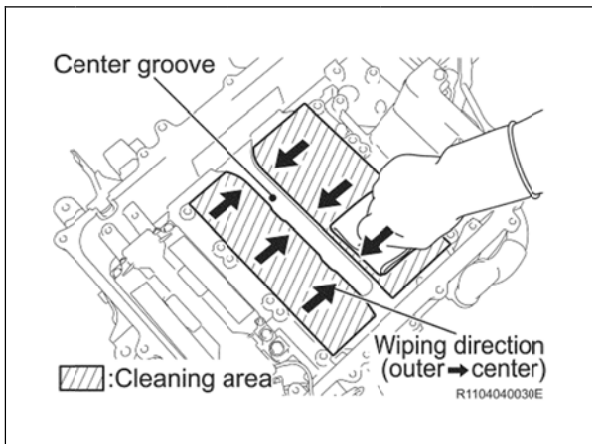

1. CLEAN THE INVERTER CASE

- a) Use a shop cloth soaked with brake cleaner to remove the grease.
- b) Wipe the grease toward the center groove in the case to avoid getting the grease in the bolt holes.



- **If grease is in the bolt holes clean carefully with a shop cloth soaked in brake cleaner.**
- **Confirm no pieces of the shop cloth remain in the inverter.**
- **Confirm all electrical terminals are free from grease.**

[Click to watch the video supplement for the following steps](#)

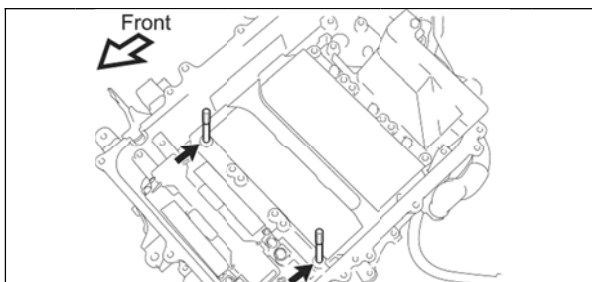

- c) Confirm **ALL** grease is removed from the inverter case.
- d) Install the 2 installation studs.

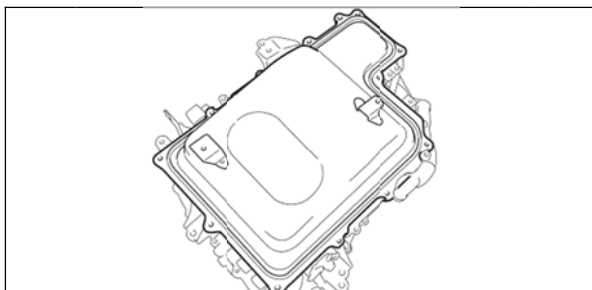

2. TEMPORARILY INSTALL THE INVERTER COVER

- a) Install the inverter cover while applying grease to the new IPM transistor to prevent contamination in the inverter assembly.

NOTE:

- **DO NOT** remove protective cover B
- **DO NOT** pinch any harnesses between the cover and inverter.

VIII. GREASE APPLICATION

**THE FOLLOWING CONFIRMATION STEPS ARE VITAL
CONFIRM THESE STEPS ARE FOLLOWED CLOSELY**

PERFORM THIS INTERMEDIATE INSPECTION BEFORE APPLYING GREASE TO THE IPM TRANSISTOR.

1. Is the smoothing capacitor stored properly with protective cover A installed?
2. Are the disconnected high voltage terminals covered with insulating tape?
3. Has the inverter case been thoroughly cleaned?
4. Is the inverter cover temporarily installed?
5. Is the grease application work space clear of dust, water and other forms of contamination?
6. Is the masking plate and squeegee clean and in good condition?
7. Have you discharged all potential static electricity from your person?

A. IPM TRANSISTOR ASSEMBLY

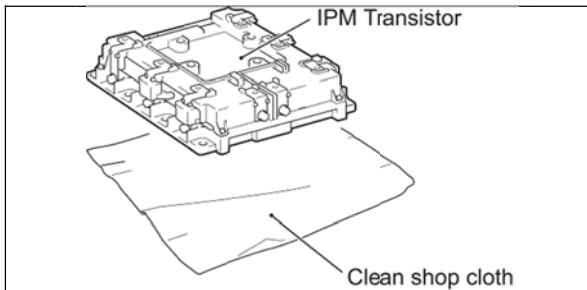

1. ASSEMBLE THE NEW IPM TRANSISTOR

- a) Place the new IPM transistor on a clean shop cloth.



DO NOT touch the circuit board that is between the upper and lower sections of the IPM transistor.

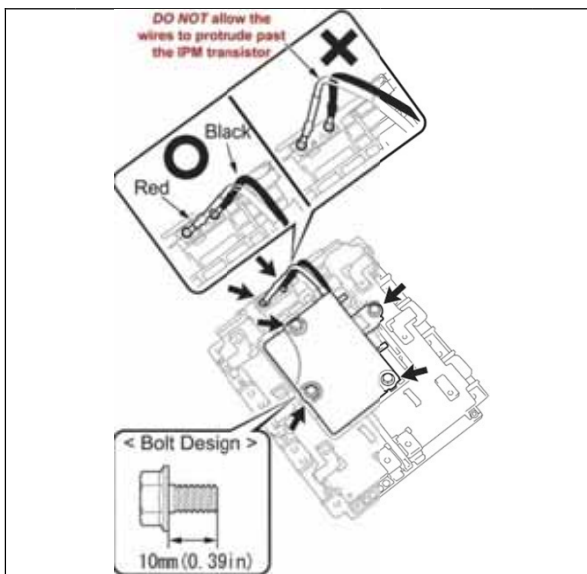

- b) Install the sub capacitor with the 4 bolts.

Torque: 6.0N·m (61kgf·cm, 53in. lbf)

- c) Install the 2 wires with the 2 screws.

NOTE:

- **DO NOT** attach the wires to the incorrect terminals.
- **Position the wires so they do not protrude past the IPM transistor.**

B. IPM TRANSISTOR GREASE APPLICATION

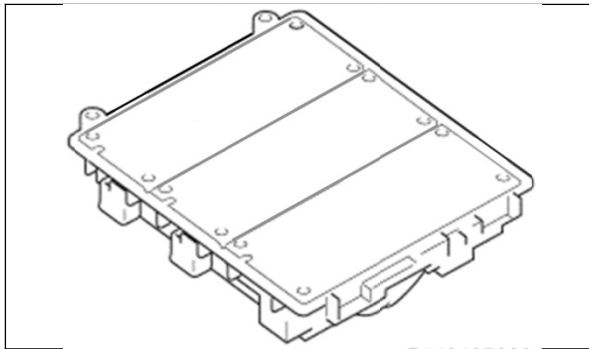

1. PLACE THE IPM TRANSISTOR UPSIDE DOWN ON A CLEAN SURFACE

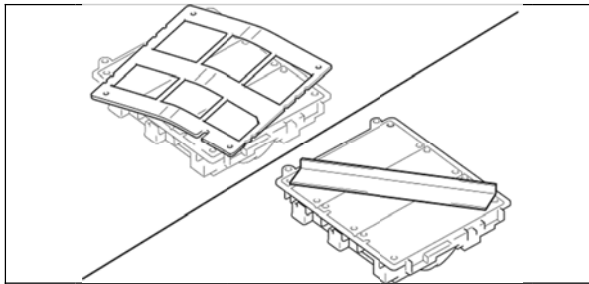

2. INSPECT THE MASKING PLATE AND SQUEEGEE
 - a) Confirm the masking plate and squeegee are clean.
 - b) Confirm the masking plate and squeegee are not bent or damaged.

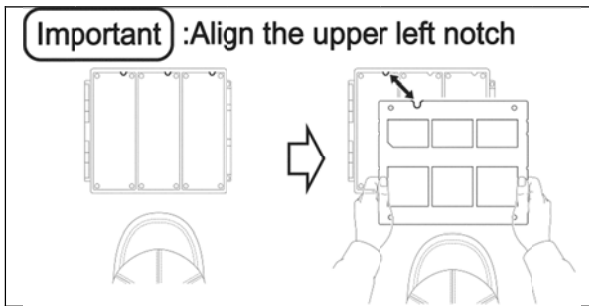

3. INSTALL THE MASKING PLATE
 - a) Place the IPM transistor so the 3 notches are at the top.
 - b) Align the upper left notch in the masking plate with the alignment notch in the IPM transistor.

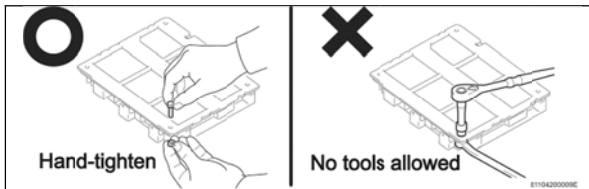

- c) Tighten the masking plate by hand using the 4 nuts/bolts provided.

NOTE: DO NOT use tools when tightening the masking plate to prevent damage.

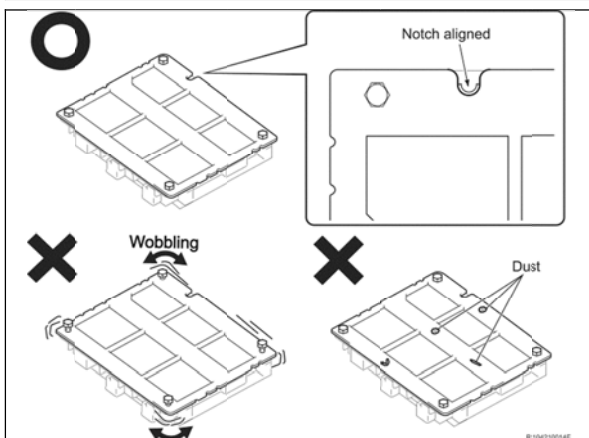

- d) Confirm the masking plate is installed in the correct position.
- e) Confirm the masking plate is securely attached.
- f) Confirm the masking plate is clean.

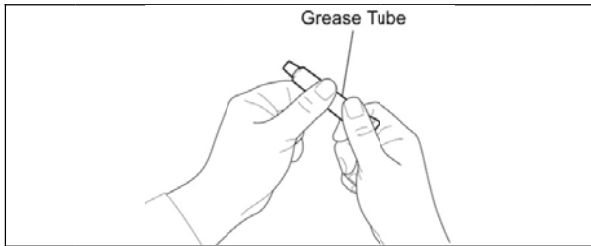

4. PREPARE 2 TUBES OF THERMAL CONDUCTIVE GREASE

- Knead the tubes to confirm the grease is properly mixed.
- Clean the tubes with brake cleaner.

NOTE: The tubes may be used to apply the grease, it is critical that they are clean.



NOTE:

- Two tubes of grease are necessary for each IPM transistor.
- The first tube of grease will cover the upper half of the IPM transistor and the second tube will cover the lower half as indicated in the illustration.

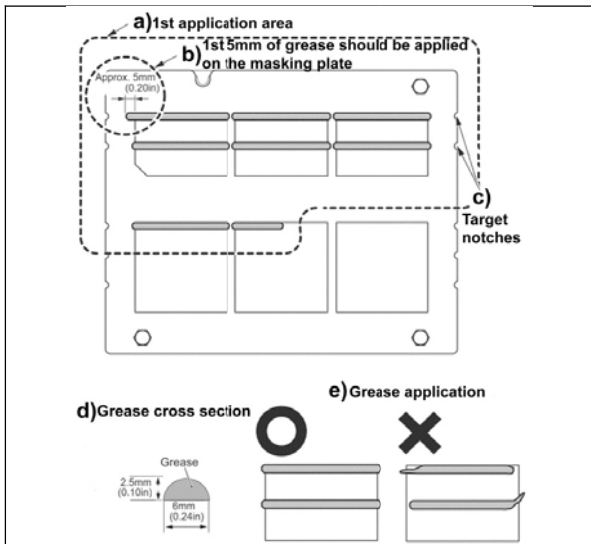

5. APPLY THE FIRST TUBE OF GREASE

- Confirm the area the first tube of grease will cover.
- Confirm the first 5mm of grease is applied on the masking plate as the initial portion of grease may not be completely mixed.
- Apply the grease by following the target notches on the masking plate.
- The grease should be applied in strips that are approximately 6mm wide and 2.5mm in height. (This is the size of the target notches on the masking plate)
- Confirm grease is applied fully from start to finish in the masking plate windows.

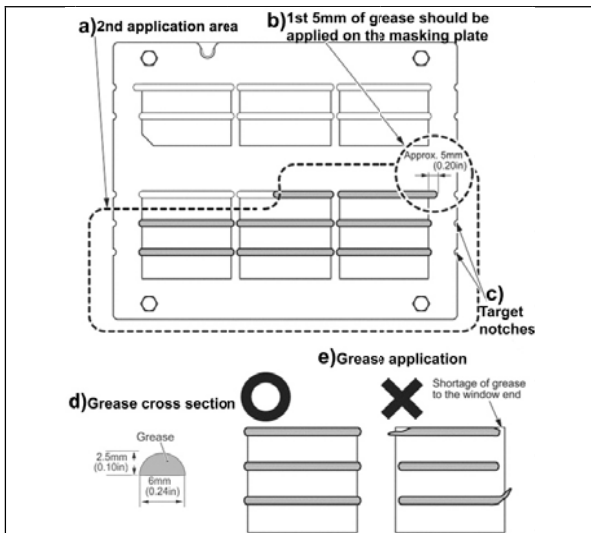

6. APPLY THE SECOND TUBE OF GREASE

- Confirm the area the second tube of grease will cover.
- Confirm the first 5mm of grease is applied on the masking plate as the initial portion of grease may not be completely mixed.
- Apply the grease by following the target notches on the masking plate.
- The grease should be applied in strips that are approximately 6mm wide and 2.5mm in height. (This is the size of the target notches on the masking plate)
- Confirm grease is applied fully from start to finish in the masking plate windows.

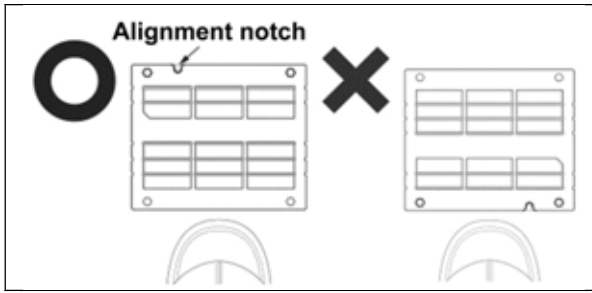

7. SPREAD THE GREASE

a) Position the IPM transistor so the alignment notch on the masking plate is in the upper left position.

b) Hold the squeegee at a 45 degree angle.

c) Beginning on the upper side of the IPM transistor, slide the squeegee down past the bottom of the application windows.

NOTE: To ensure all grease is used effectively, *DO NOT* slide the squeegee into the bolts.

d) Lift the squeegee with the grease.

e) Turn the squeegee around and slide it from the bottom of the IPM transistor up past the top of the application windows.

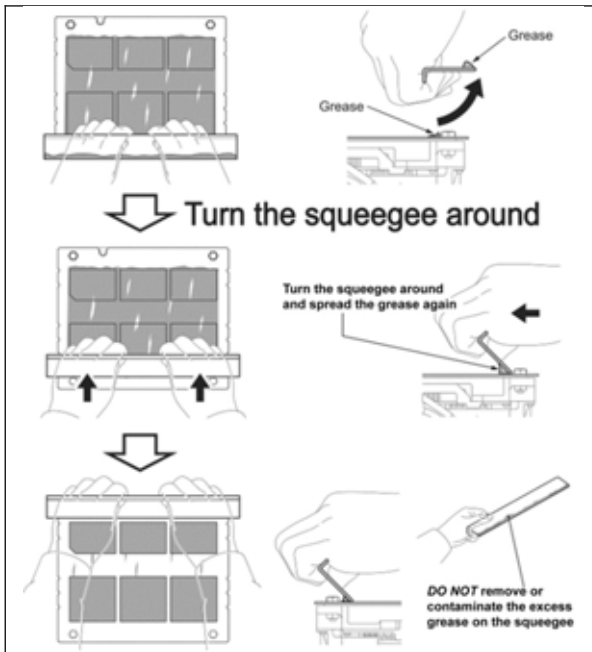
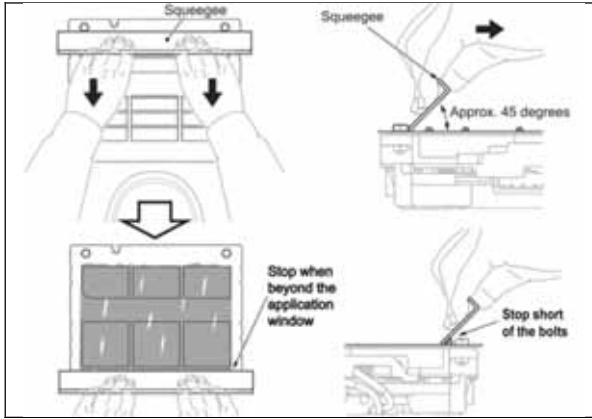

STOP *DO NOT* remove the excess grease from the squeegee until it has been confirmed that the grease has been spread correctly.

**THE FOLLOWING STEPS ARE VITAL
CONFIRM THESE STEPS ARE FOLLOWED CLOSELY**

CONFIRM THE CONDITION OF THE THERMAL CONDUCTIVE GREASE

SAMPLE	CONDITION & ACTION REQUIRED
	<p>CONDITION: Smooth surface and complete coverage.</p> <p>ACTION: Proceed to: SECTION X. REASSEMBLY</p>
	<p>CONDITION: Grease unsmooth. Metal surface of the IPM transistor NOT visible through the grease.</p> <p>ACTION: Proceed to: SECTION X. REASSEMBLY</p>
	<p>CONDITION: Grease unsmooth. Metal surface of the IPM transistor visible through the grease.</p> <p>ACTION: Proceed to: STEP C #2. REAPPLY GREASE TO THE NEEDED AREAS</p>
	<p>CONDITION: Hole or imperfection in the grease exposing the metal surface of the IPM transistor.</p> <p>ACTION: Proceed to: STEP C #2. REAPPLY GREASE TO THE NEEDED AREAS</p>
	<p>CONDITION: Foreign material in the grease.</p> <p>ACTION: Proceed to: STEP C #1. REMOVE FOREIGN MATERIAL FROM THE GREASE</p>

C. GREASE APPLICATION CORRECTION

(Only perform these steps if the above inspection determines it is necessary)

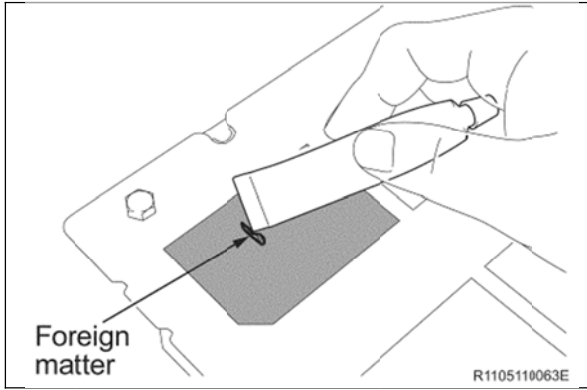

1. REMOVE FOREIGN MATERIAL FROM THE GREASE

- a) Use one of the tubes of grease to remove the foreign material from the grease.

NOTE: Confirm the tube is clean before use.

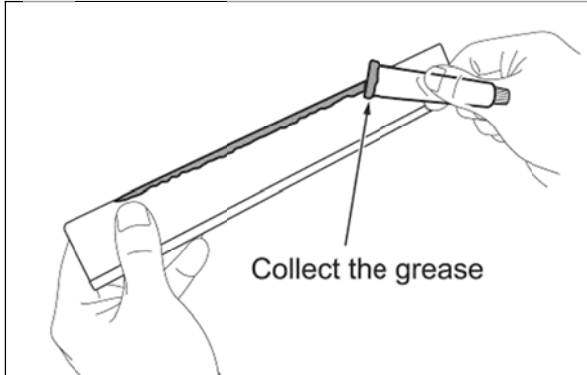

2. REAPPLY GREASE TO THE NEEDED AREAS

- a) Collect the grease remaining on the squeegee using one of the tubes of grease.

NOTE: Confirm the tube is clean before use.

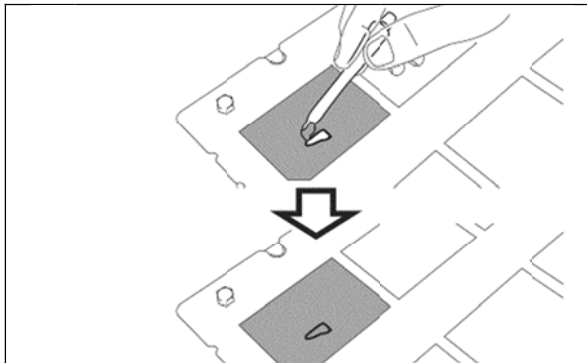

- b) Apply the grease the areas with a shortage.

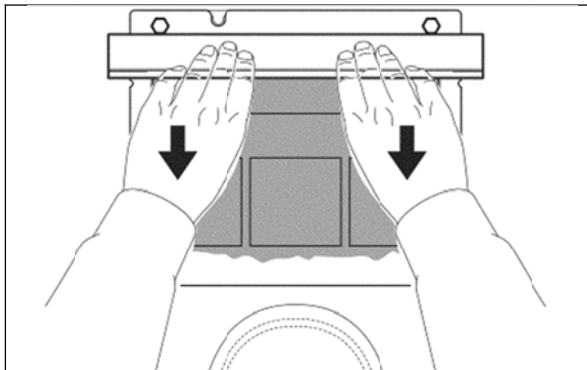

- c) Use the squeegee as before to smooth the grease.

- d) Reconfirm the condition of the grease using the confirmation steps on the previous page.

IX. REASSEMBLY

A. INVERTER REASSEMBLY

**TORQUE SPECIFICATIONS INSIDE THE INVERTER ARE CRITICAL
CONFIRM ALL BOLTS ARE TORQUED AS OUTLINED IN THESE INSTRUCTIONS**

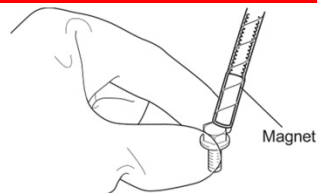

NOTE:

- To prevent dropping any bolts into the inverter it may be necessary to use a magnet to set the bolts as they are installed.
- If bolts are dropped into the bottom section of the inverter it may be necessary to completely remove the inverter for retrieval.

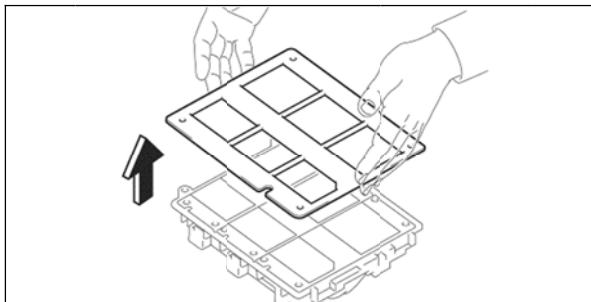

1. REMOVE THE MASKING PLATE

- a) Remove the 4 nuts and bolts.
- b) Slowly remove the masking plate.



- **DO NOT** displace the grease when removing the masking plate. If the grease is scraped off when removing the plate, return to **STEP B. IPM TRANSISTOR GREASE APPLICATION**

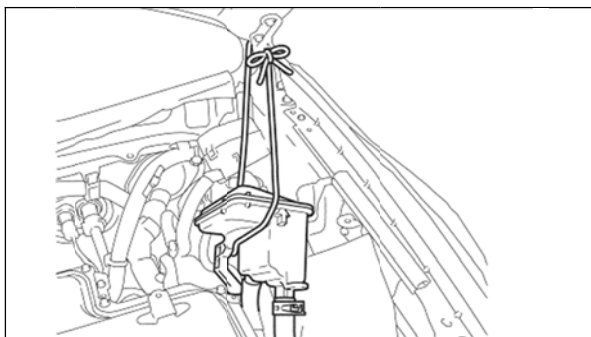

2. CONFIRM THE INVERTER RESERVE TANK SUB ASSEMBLY IS NOT LEAKING

- a) Before installing the IPM transistor, confirm there is no coolant leaking.

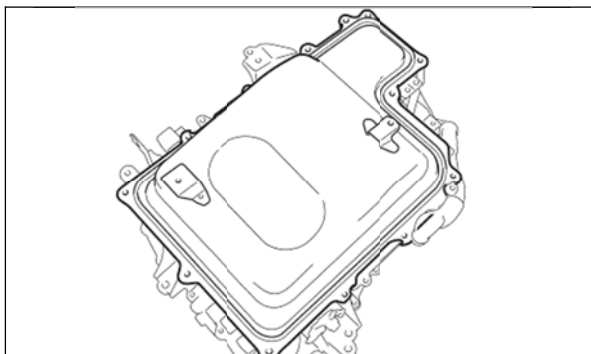

3. INSTALL THE NEW IPM TRANSISTOR



- Be sure to wear electrical insulating gloves during the inverter reassembly procedure.

- a) Remove the inverter cover.

[Click here to watch the video supplement for steps 3-12](#)

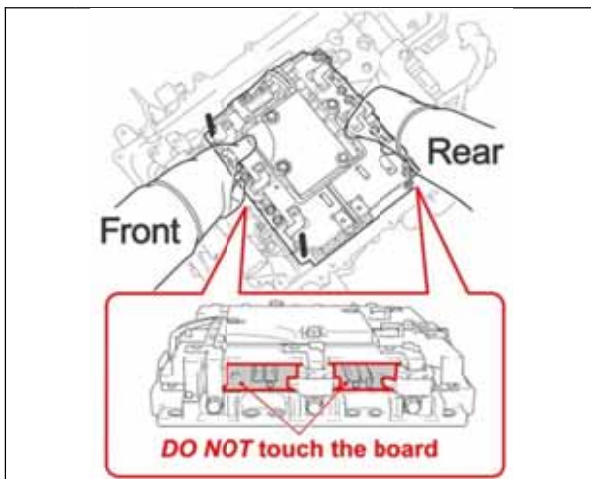

- Confirm the inside of the inverter is clean.
- **DO NOT** touch the circuit board in the IPM transistor.
- Confirm the 2 installation studs are installed.

- b) Hold the front and back of the IPM transistor and place it in the inverter.

NOTE: Confirm the IPM transistor is positioned correctly before installation as it can be installed in two different positions.

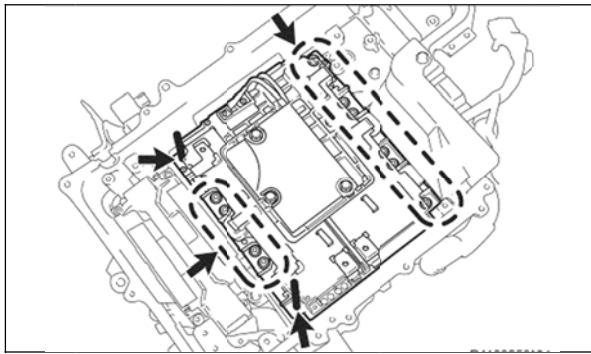

- c) Loosely install 10 bolts.
- d) Remove the 2 installation studs.
- e) Loosely install the 2 remaining bolts.

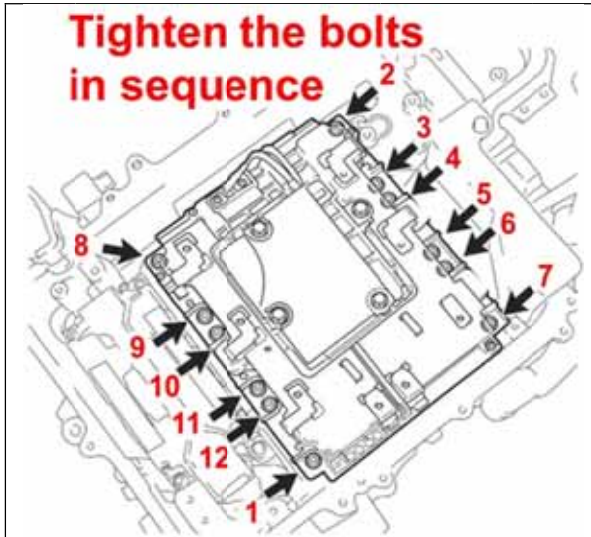

- f) Tighten the 12 bolts in the sequence shown in the illustration.

Torque: 6N·m (61kgf·cm, 53 in.lbf)

NOTE: Confirm the 12 bolts are tightened in the correct sequence to ensure the grease contacts correctly.

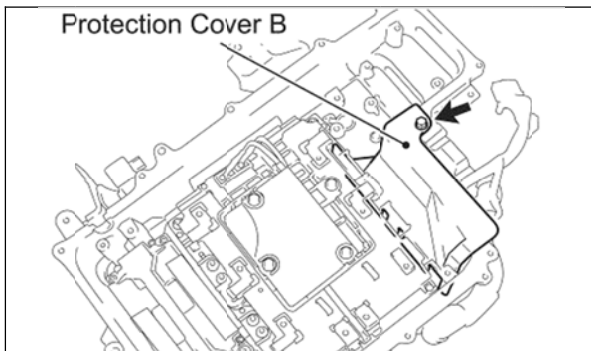

4. 4WD ONLY –REMOVE PROTECTIVE COVER B

NOTE: Protective Cover B will be removed on STEP 11 on 2WD vehicles.

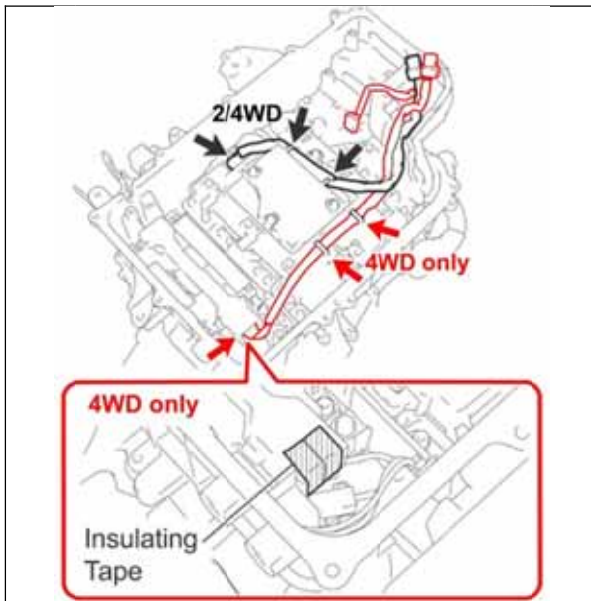

5. INSTALL THE INVERTER WIRE HARNESSES

- a) **4WD ONLY** – Connect the 2 clamps and 1 connectors.
- 2/4WD** – Connect the 2 clamps and the connector.

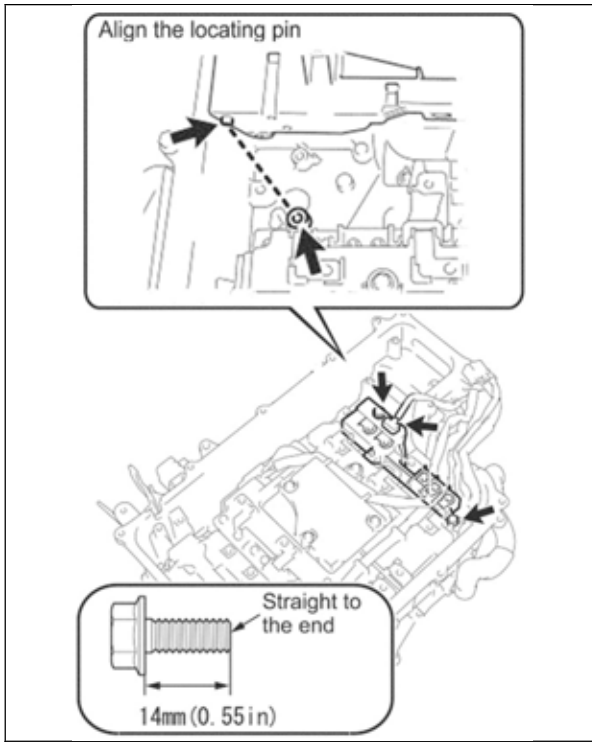

6. 4WD ONLY – INSTALL THE INVERTER CURRENT SENSOR No.1

- a) Install the current sensor. Confirm the sensor is installed in the locating pin.
- b) Install the 2 bolts.

Torque: 8N·m (82kgf·cm, 71 in.lbf)



The bolts can be installed even if the locating pin is not aligned. Confirm the sensor is installed in the locating pin.

- c) Connect the electrical connector.

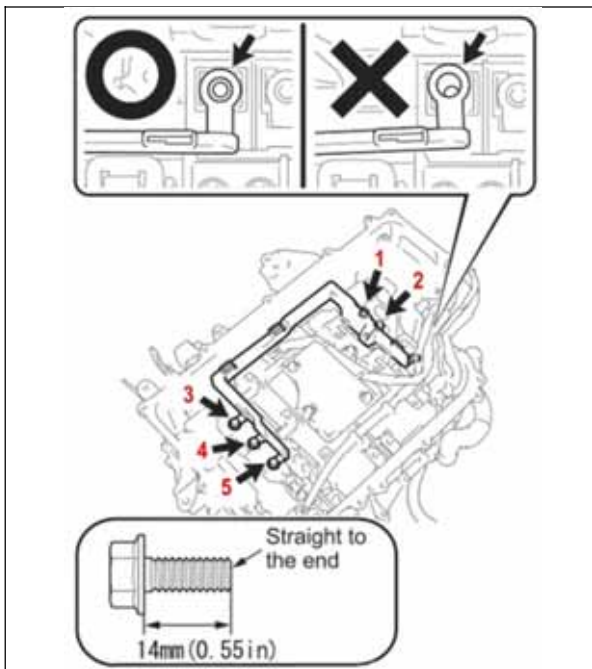

7. 4WD ONLY – INSTALL THE MGR BUS BAR

- a) Remove the insulating tape attached to the terminals and confirm they are clean.
- b) Install the bus bar.
- c) Install the 5 bolts in the sequence shown in the illustration.

Torque: 8N·m (82kgf·cm, 71 in. lbf)

NOTE: DO NOT install a bolt in the sixth hole at this time, only confirm the terminal is aligned correctly.

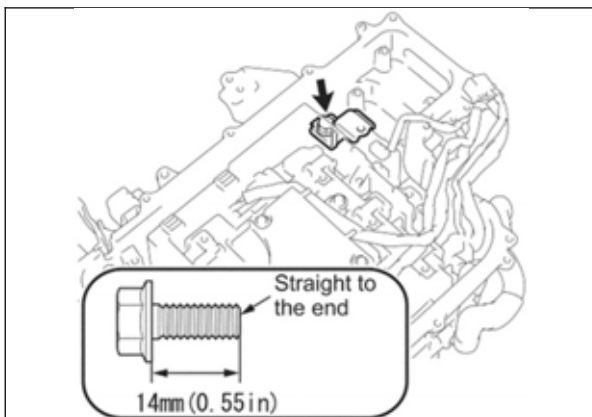

8. 4WD ONLY – INSTALL THE INVERTER BRACKET

- a) Install the bracket with 1 bolt.

Torque: 8N·m (82kgf·cm, 71 in. lbf)

NOTE: The inverter bracket should be present on 2WD vehicles, the bracket should not have been removed.

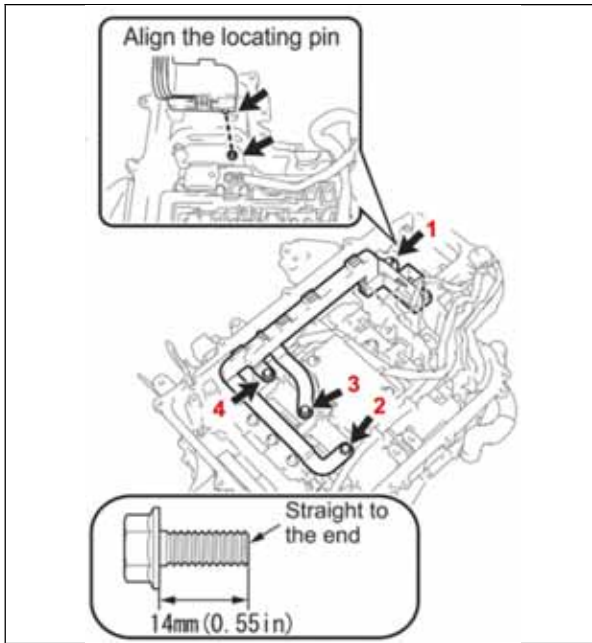

9. INSTALL THE MG1 BUS BAR

- a) Confirm the terminals are clean.
- b) Install the bus bar. Confirm the bus bar is installed in the locating pin.
- c) Install the 4 bolts in the sequence shown in the illustration.

Torque: 8N·m (82kgf·cm, 71in. lbf)



The bolts can be installed even if the locating pin is not aligned. Confirm the sensor is installed in the locating pin.

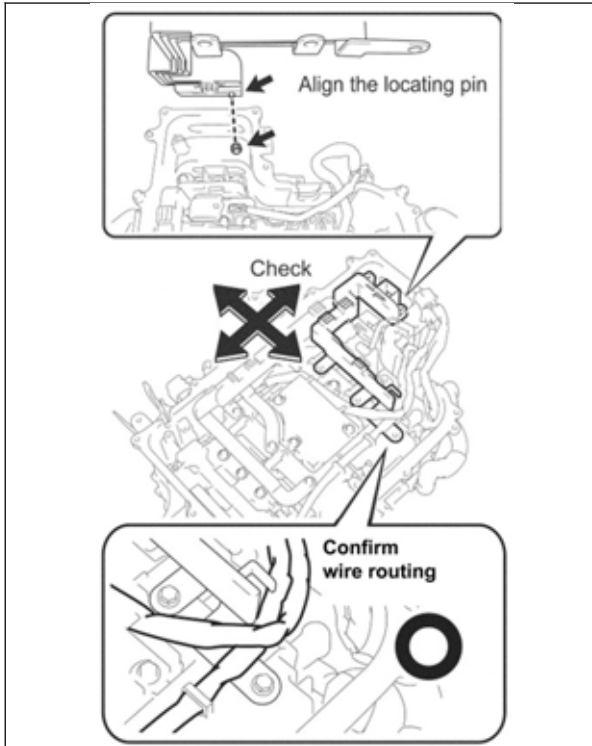

10. INSTALL THE MG2 BUS BAR

- a) Confirm the terminals are clean.
- b) Install the bus bar. Confirm the bus bar is installed in the locating pin.

NOTE:

- Confirm the harnesses are routed correctly.



The bolts can be installed even if the locating pin is not aligned. Confirm the sensor is installed in the locating pin.

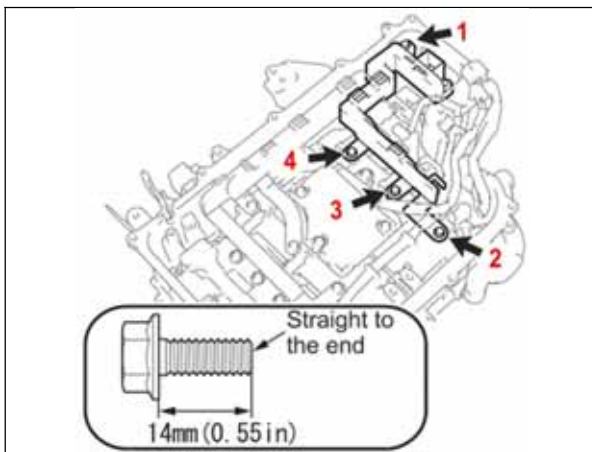

- c) Install the 4 bolts in the sequence shown in the illustration.

Torque: 8N·m (82kgf·cm, 71in. lbf)



The bolts can be installed even if the locating pin is not aligned. Confirm the sensor is installed in the locating pin.

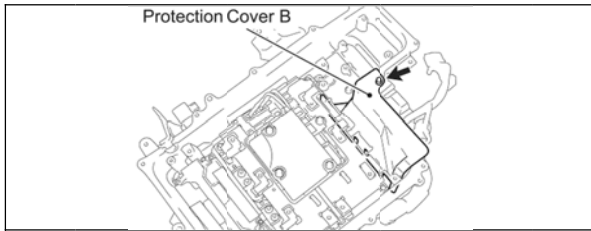

11. 2WD ONLY – REMOVE PROTECTIVE COVER B

NOTE: Protective Cover B was removed on STEP 4 on 4WD vehicles.

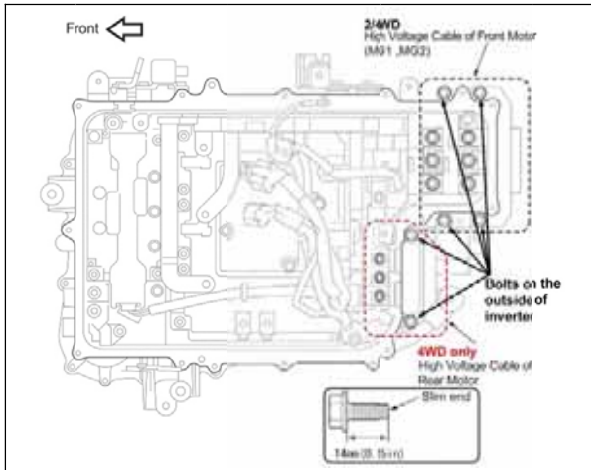

12. INSTALL THE HIGH VOLTAGE CABLES

- Remove the insulating tape attached to the terminals and confirm they are clean.
- 4WD – Install the 15 bolts.
2WD – Install the 10 bolts.

Torque: 10N·m (102kgf·cm, 84in. lbf)

NOTE: If there is difficulty installing the high voltage cables, reconfirm the bus bars are installed in their locating pins.

To prevent contamination, **DO NOT** use the bolts that were removed from the outside of the inverter on the inside.

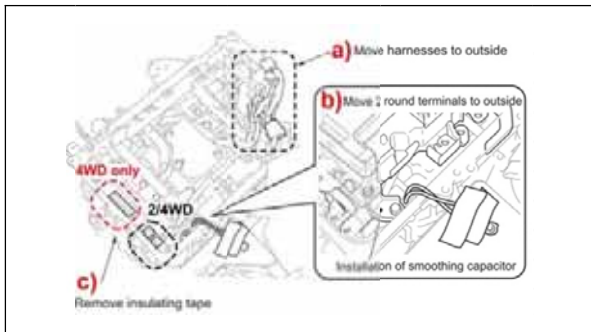

13. PREPARE THE INVERTER FOR SMOOTHING CAPACITOR INSTALLATION

- Secure the inverter harnesses so they do not interfere when installing the smoothing capacitor.
- Move the 2 terminals that were fixed inside the inverter during the disassembly process to the outside of the inverter.
- Remove the insulating tape attached to the terminals.

[Click here to watch the video supplement for remaining steps](#)

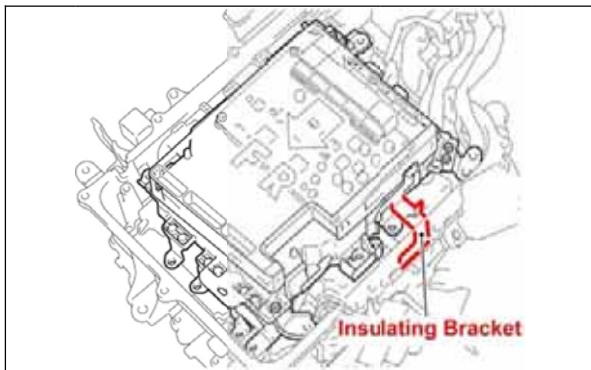

14. INSTALL THE SMOOTHING CAPACITOR

- Hold the smoothing capacitor with protective cover A installed.
- Carefully place the smoothing capacitor in the inverter.

- **DO NOT** catch any wires when installing the smoothing capacitor.
- **Pay close attention to the insulating bracket, this bracket must not be bent and must be positioned between the inverter case and the IPM transistor.**

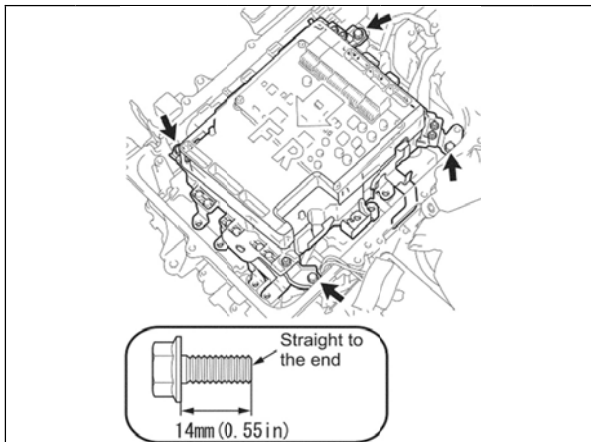

- Install the 4 bolts.

Torque: 8N·m (82kgf·cm, 71in. lbf)

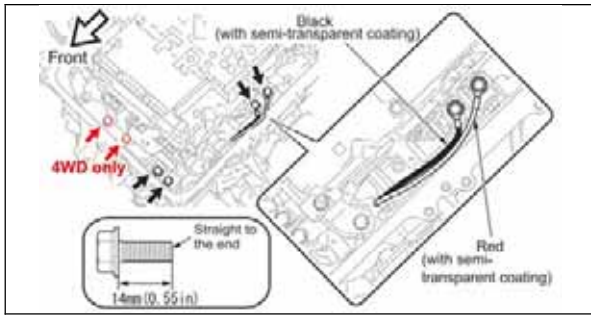

- d) Remove the insulating tape on the 2 wires.
- e) Install the bolts.
 - 4WD** – Install the 6 bolts.
 - 2WD** – Install the 4 bolts.

Torque: 8N·m (82kgf·cm, 71in. lbf)

NOTE: DO NOT mistake the connection points of the terminals.

15. INSTALL THE AIR CONDITIONING HARNESS SUB ASSEMBLY

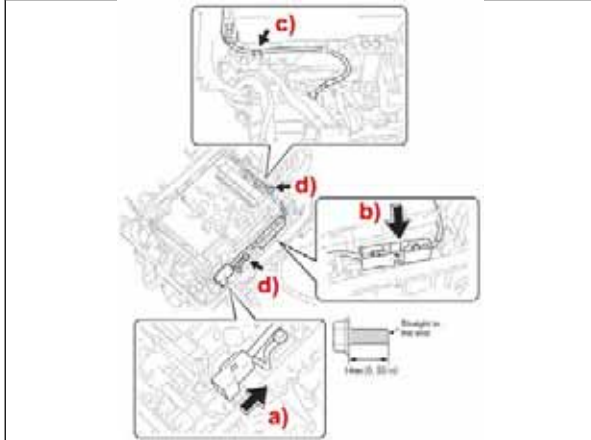

- a) Install the connector.
- b) Install the fuse box.
- c) Confirm the harness is routed correctly.

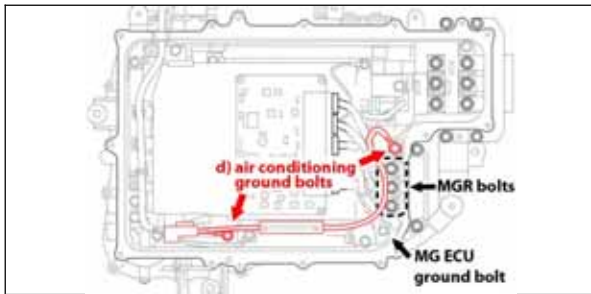

- d) Confirm the terminals are clean and install the 2 ground bolts.

Torque: 8N·m (82kgf·cm, 71in. lbf)

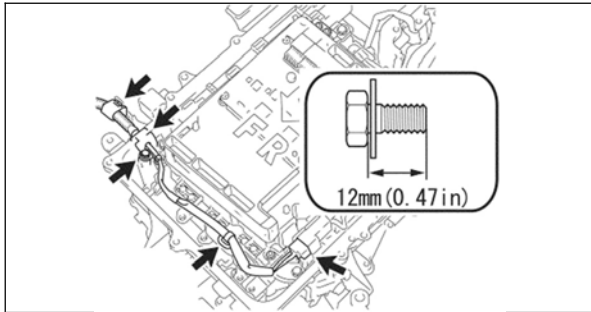

16. CONNECT THE ENGINE WIRE No.4

- a) Remove the insulating tape from the terminal.
- b) Connect the connector, the harness clamps, and the grommet.
- c) Install the bolt.

Torque: 6N·m (61kgf·cm, 53in. lbf)

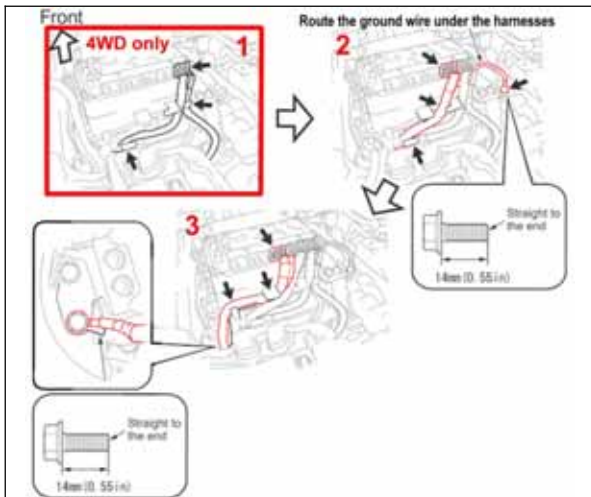

17. CONNECT THE MG ECU CONNECTORS

- a) Remove the insulating tape from the connectors.
- b) Remove protective cover A.
- c) Connect the connectors following the sequence in the illustration.
 - 4WD** – 3 connectors
 - 2WD** – 2 connectors
- d) Connect the 2 ground bolts.

Torque: 8N·m (82kgf·cm, 71in. lbf)



- Confirm that all harnesses are routed correctly and all connectors and ground bolts are secure.
- **DO NOT touch the MG ECU.**

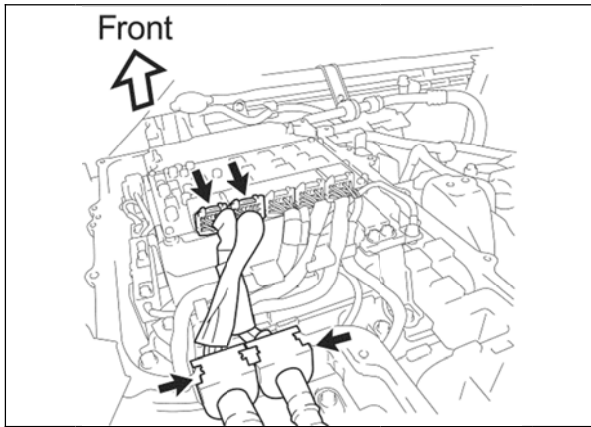

e) Connect the 2 connectors and fit the 2 grommets.



- **Cross the 2 harnesses inside the inverter.**
- **The harnesses can be crossed in either direction.**
- **Confirm the grommets are clean before installing to prevent leaks.**

**THE FOLLOWING CONFIRMATION STEPS ARE VITAL
CONFIRM THESE STEPS ARE FOLLOWED CLOSELY**

PERFORM THIS INTERMEDIATE INSPECTION BEFORE INSTALLING THE INVERTER CASE COVER.

1. Are the high voltage cables (MG1, MG2 and MGR for 4WD) connected correctly?
2. Are all of the MG ECU connectors secured and the ground bolts connected?
3. Have all components been installed correctly in the inverter assembly?

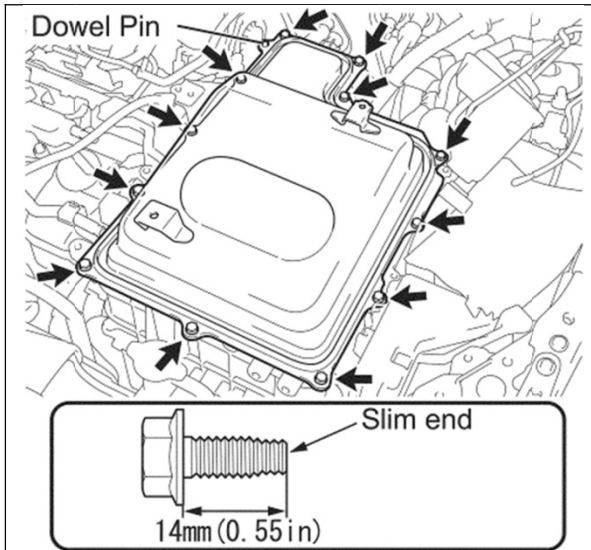

18. INSTALL THE INVERTER COVER

- a) Confirm the cover gasket is set in the cover groove.
- b) Confirm the cover gasket and inverter mating surface are clean.
- c) Install the cover using the 12 bolts.

Torque: 10N·m (102kgf·cm, 84in. lbf)

NOTE: The cover gasket can be reused even if it has come out of the groove.

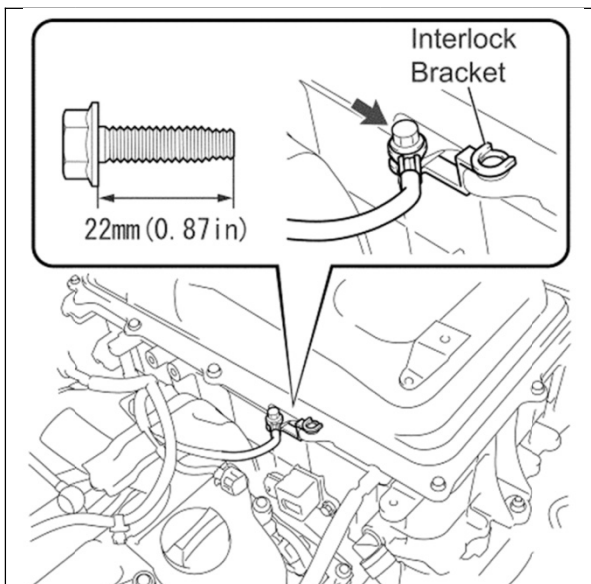

- d) Remove the insulating tape from the interlock bracket.
- e) Install the bracket with the 1 bolt.

Torque: 10N·m (102kgf·cm, 84in. lbf)

B. VEHICLE REASSEMBLY

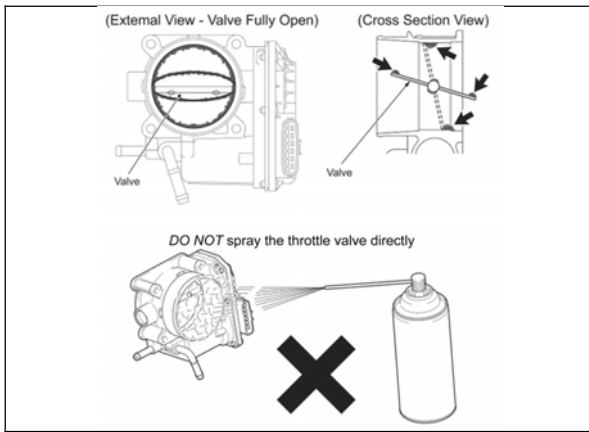

1. CLEAN THE THROTTLE BODY

- Use a shop cloth soaked in throttle plate cleaner to clean the throttle body.

NOTE:

- DO NOT** spray the throttle valve directly.
- This procedure should be performed to ensure the engine learn values are set correctly.

2. INSTALL THE COMPONENTS ILLUSTRATED BELOW

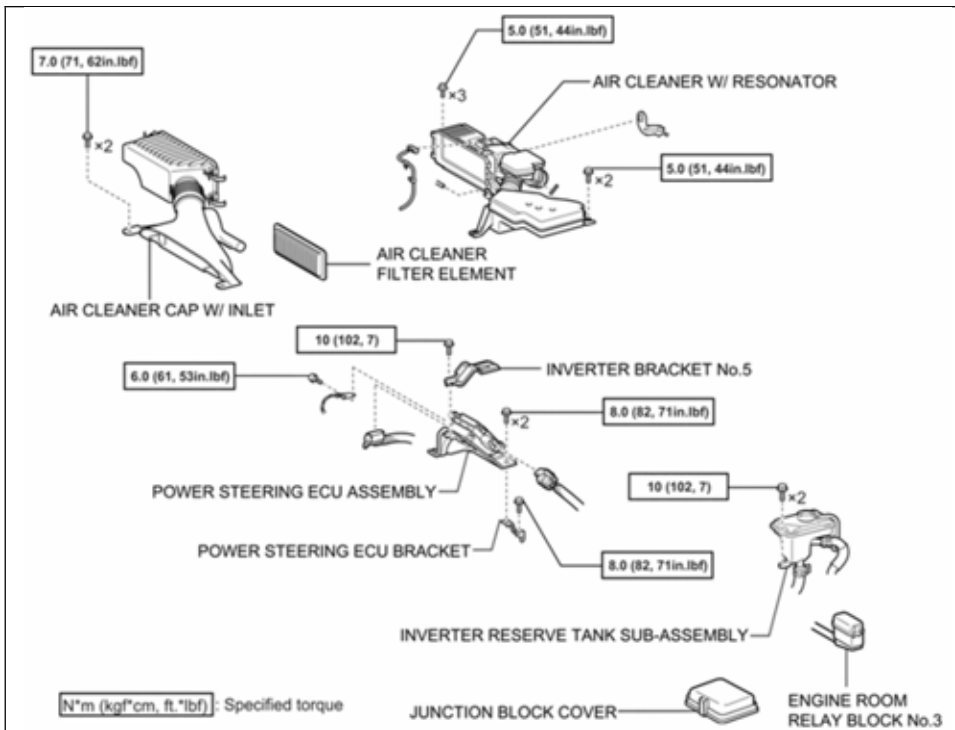

NOTE:

- Install **ALL** air intake system components prior to attempting **READY ON**; otherwise, DTCs may occur.
- Wear insulating gloves when installing the power steering ECU components.
- For detailed installation information, refer to the repair manual.

3. INSTALL THE SERVICE GRIP

4. INSTALL THE NEGATIVE BATTERY CABLE

5. CONFIRM VEHICLE OPERATION

- Turn the vehicle to **READY ON**.
- Confirm the vehicle is in park.
- Turn the air conditioner on high and allow vehicle to run for 3 minutes.
- Confirm auxiliary battery voltage.

Specification: 13 to 15 V

- Check for DTCs. If DTCs are output use the repair manual and the trouble shooting table in the Appendix of these instructions to diagnose.

NOTE:

- If DTCs are present after IPM replacement, first confirm IPM replacement was performed correctly, if it is determined that inverter replacement is required you **MUST** contact TAS (800-233-3178) to confirm your diagnosis, then contact your regional representative to obtain operation codes for dealership reimbursement.
- If DTCs that were not present prior to IPM replacement are present after IPM replacement, confirm IPM replacement was performed correctly.

6. INSTALL ALL REMAINING COMPONENTS
7. CHECK FOR DIAGNOSTIC TROUBLE CODES
8. TEST DRIVE THE VEHICLE
9. PERFORM SYSTEM INITIALIZATIONS

◀ VERIFY REPAIR QUALITY ▶

- Confirm the part number *AND* serial number before replacing the IPM transistor
- Confirm the work area is very clean before disassembling the inverter
- Confirm *ALL* removal steps are followed, to prevent damage *DO NOT* skip any steps
- Confirm the inverter is cleaned thoroughly and the grease is applied correctly to the IPM transistor
- Confirm *ALL* installation steps are followed

If you have any questions regarding this recall, please contact your regional representative

X. APPENDIX

A. RECALL PARTS DISPOSAL

As required by Federal Regulations, please make sure all recalled parts (original parts) removed from the vehicle are disposed of in a manner in which they will not be reused, ***unless requested for parts recovery return.***

B. TROUBLESHOOTING TABLE

Use this table if any DTCs are output after performing the campaign. If the DTC output is not listed in this table, or checking the connectors does not remedy the condition, refer to the repair manual for additional diagnostic information.

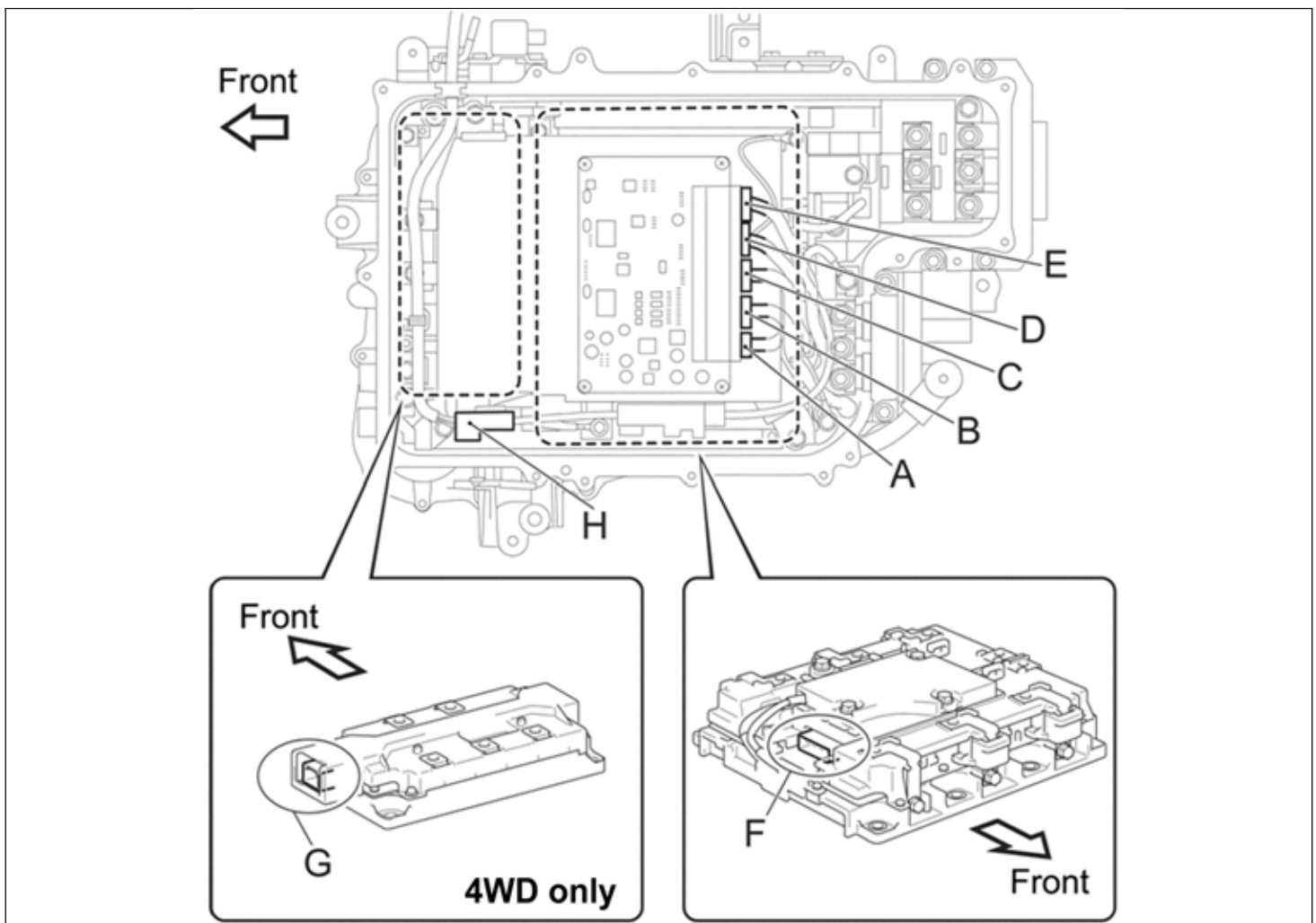

DTC	Connector to inspect							
	A	B	C	D	E	F	G	H
B1477/71								O
B1477/77								O
P0A02-719			O					
P0A03-720			O					
P0A08-264		O						
P0A09-265		O						
P0A10-263		O						
P0A1A-151	O	O	O	O	O			
P0A1A-155	O	O	O	O	O			
P0A1A-156	O	O	O	O	O			
P0A1A-158	O	O	O	O	O			
P0A1A-166	O	O	O	O	O			
P0A1A-200	O	O	O	O	O			
P0A1A-658	O	O	O	O	O			
P0A1A-659	O	O	O	O	O			
P0A1A-791	O	O	O	O	O			
P0A1A-792	O	O	O	O	O			
P0A1A-793	O	O	O	O	O			
P0A1B-163	O	O	O	O	O			
P0A1B-164	O	O	O	O	O			
P0A1B-168	O	O	O	O	O			
P0A1B-192	O	O	O	O	O			
P0A1B-193	O	O	O	O	O			
P0A1B-195	O	O	O	O	O			
P0A1B-196	O	O	O	O	O			
P0A1B-198	O	O	O	O	O			
P0A1B-511	O	O	O	O	O			
P0A1B-512	O	O	O	O	O			
P0A1B-661	O	O	O	O	O			
P0A1B-662	O	O	O	O	O			
P0A1B-781	O	O	O	O	O			
P0A1B-786	O	O	O	O	O			
P0A1B-788	O	O	O	O	O			
P0A1B-794	O	O	O	O	O			
P0A1B-795	O	O	O	O	O			
P0A1B-796	O	O	O	O	O			
P0A1C-706	O	O	O	O	O			
P0A1C-707	O	O	O	O	O			
P0A1C-708	O	O	O	O	O			
P0A1C-709	O	O	O	O	O			
P0A1C-710	O	O	O	O	O			
P0A1C-711	O	O	O	O	O			
P0A1C-713	O	O	O	O	O			
P0A1C-715	O	O	O	O	O			
P0A1C-797	O	O	O	O	O			
P0A1C-798	O	O	O	O	O			
P0A1C-799	O	O	O	O	O			
P0A3F-243	O							
P0A40-500	O							

DTC	Connector to inspect							
	A	B	C	D	E	F	G	H
P0A41-245	O							
P0A45-669		O						
P0A46-671		O						
P0A47-670		O						
P0A4B-253	O							
P0A4C-513	O							
P0A4D-255	O							
P0A55-687					O		O	
P0A60-288				O		O		
P0A60-289				O		O		
P0A60-290				O		O		
P0A60-292				O		O		
P0A60-294				O		O		
P0A60-501				O		O		
P0A63-296				O		O		
P0A63-297				O		O		
P0A63-298				O		O		
P0A63-300				O		O		
P0A63-302				O		O		
P0A63-502				O		O		
P0A69-677					O		O	
P0A69-679					O		O	
P0A69-680					O		O	
P0A69-683					O		O	
P0A69-684					O		O	
P0A69-688					O		O	
P0A6C-678					O		O	
P0A6C-681					O		O	
P0A6C-682					O		O	
P0A6C-685					O		O	
P0A6C-686					O		O	
P0A6C-689					O		O	
P0A72-326				O		O		
P0A72-327				O		O		
P0A72-328				O		O		
P0A72-330				O		O		
P0A72-333				O		O		
P0A72-515				O		O		
P0A75-334				O		O		
P0A75-335				O		O		
P0A75-336				O		O		
P0A75-338				O		O		
P0A75-341				O		O		
P0A75-516				O		O		
P0A78-278				O		O		
P0A78-280				O		O		
P0A78-283				O		O		
P0A78-285				O		O		
P0A79-690					O		O	

DTC	Connector to inspect							
	A	B	C	D	E	F	G	H
P0A79-691					O		O	
P0A7A-321				O		O		
P0A7A-323				O		O		
P0A94-545			O					
P0A94-546			O					
P0A94-551			O					
P0A94-552			O					
P0A94-587			O					
P0AA6-526								
P0AA6-613								
P0AA6-614								
P0AA6-655								
P0AEF-275				O				
P0AF0-274				O				
P0AF4-673					O			
P0AF4-674					O			
P3222-313				O				
P3223-312				O				
P3227-583		O						
P3228-584		O						
U0110-159	O	O	O	O	O			
U0110-160	O	O	O	O	O			
U0110-656	O	O	O	O	O			
U0110-657	O	O	O	O	O			
Auxiliary battery voltage error		O						