



**R10RW**

May 26, 2010

Dear Blue Bird Owner:

This notice is sent to you in accordance with the requirements of the National Traffic and Motor Vehicle Safety Act.

Blue Bird has decided that a defect which relates to motor vehicle safety exists on certain 2004 through 2009 model year "Vision" conventional **school buses** manufactured from January 30, 2003 through September 24, 2008.

On the subject buses, the main power cable lugs (eyelets) may have been improperly oriented at the power distribution unit (PDU) and the driver's control module (DCM). If the power cable lug(s) are improperly oriented vibration may wear the insulation permitting direct contact between the bare lug and the PDU or DCM which could cause a direct short with potential for fire.

Blue Bird is conducting a recall to correct this defect. Buses with this defect must be inspected for proper power cable lug orientation and, if needed, power cable lugs re-oriented according to the enclosed instructions for Recall R10RW.

Your Blue Bird bus(es) affected by this recall are identified by body serial number(s) on the enclosed reply sheets. If you no longer own the subject bus(es), please complete the appropriate section of the **pink** reply sheet and return to Blue Bird in the enclosed pink postage prepaid envelope.

Labor time to inspect for proper orientation of power cable lugs is 0.5 hrs per bus.

Labor time to inspect for proper orientation of power cable lugs and re-orient lugs at one location (DCM or PDU) is 0.8 hours per bus.

Labor time to inspect for proper orientation of power cable lugs and re-orient lugs at two locations (DCM and PDU) is 1.1 hours per bus.

Reimbursement for labor may be obtained by completing the enclosed **labor reimbursement sheet** and returning it to Blue Bird in the enclosed **pink** postage prepaid envelope.

**BLUE BIRD BODY COMPANY**

P.O. Box 937 – 402 Blue Bird Blvd – Fort Valley, Georgia – (478) 825-2021

If the modifications directed by this notification were performed on your bus prior to the receipt of this recall notification, complete and sign the recall reply sheet and attached a copy of the work order/invoice. Mail the documents in the **pink** self-addressed postage paid envelope included with the recall notification to Blue Bird for warranty consideration. Reimbursements will be made in accordance with the requirements of the National Highway Transportation Safety Act, Title 49 Code of Federal Regulations, Parts 573 and 577.

Federal law requires that any vehicle lessor receiving this recall notice must forward a copy of this notice to the lessee within ten days.

If Blue Bird Body Company should fail to or is unable to remedy this condition without charge to you, you may contact:

**ADMINISTRATOR  
NATIONAL HIGHWAY TRAFFIC SAFETY ADMINISTRATION  
1200 NEW JERSEY AVENUE, SE  
WASHINGTON, D.C. 20590**

Or, you may call The National Highway Traffic Safety Administration toll free at:

1-888-327-4236  
TTY 1-800-424-9153

Or, go to: [HTTP://WWW.SAFERCAR.GOV](http://WWW.SAFERCAR.GOV)

Questions regarding this recall campaign should be directed to me at (478) 822-2242.

Thank you,



Bill Coleman  
Corporate Recall Administrator  
**BLUE BIRD CORPORATION**



# Incorrect Power Cable Lug Orientation

# RECALL

Models Affected: 2004 through 2009 Vision

## ISSUE

The power cables running to the power distribution unit (PDU) and driver's control module (DCM) may have been installed with the lug (eyelet) flat side up. Vibration of the bus may cause the insulation to wear permitting direct contact between the PDU or DCM which could result in a direct short in the electrical system.

## CORRECTIVE ACTION

The power cable connections at the DCM and PDU must be inspected to determine if the power cable lugs were incorrectly installed (flat side up). If they were installed incorrectly, disconnect the cable(s) and reinstall correctly per the procedure listed below. If the cable(s) are found to be damaged, contact Blue Bird Recall Administration for further instructions.

## PROCEDURE: NOTE: ALWAYS READ THE ENTIRE PROCEDURE BEFORE PERFORMING

**WARNING:** Always follow all Federal, State, Local and Shop safety standards and use proper safety equipment when performing these procedures.

**WARNING:** Ensure that no wires are pinched at the Power Distribution Unit (PDU) when PDU is slid back into position.

**Caution:** Be sure to replace any broken or removed wire ties.

**PARTS:** (If needed, contact Blue Bird Recall Administration)

00024076 Button Head Cable Tie 14.75 X .22W

00029999 Cable, Tie, 14.75L x .22W

## INSPECTION OF DRIVER'S CONTROL MODULE (DCM)

1. Park the vehicle on a level surface, apply parking brake, turn engine off, remove ignition key and chock wheels.
2. Disconnect batteries. *Always remove negative cables first.*
3. Open engine hood and locate the Chassis Power Stud(s) on the driver's side of the **Driver's Control Module (DCM)**. Depending on the type of engine installed and options on the vehicle (air conditioning and/or lift), there could be one or two power studs next to the Ground Stud. See the following diagrams.

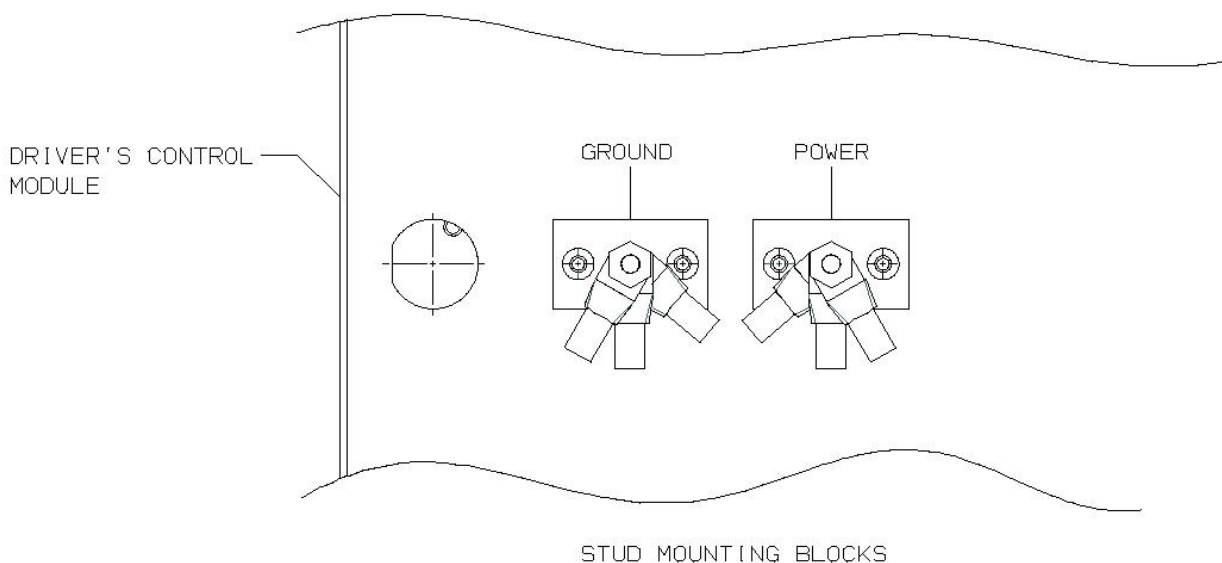

R I O R W

R E C A L L C A M P A I G N



# Incorrect Power Cable Lug Orientation

# RECALL

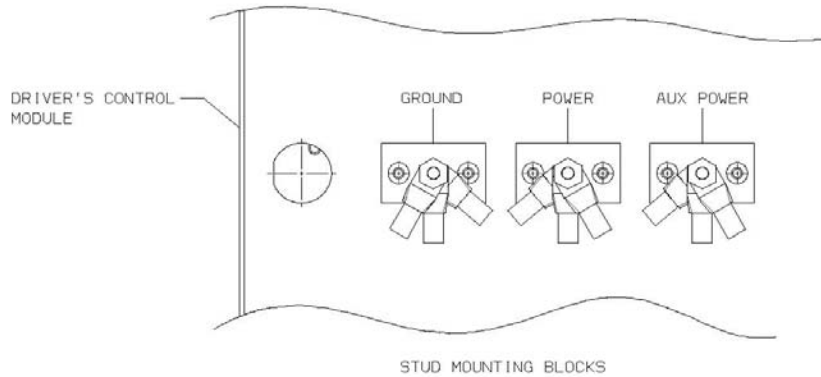

4. Inspect the electrical cable connections at the Power Stud and Aux Power Stud, if installed. See the diagram below to determine if the cables were installed correctly. ALL terminal lugs on each power stud should be oriented such that the barrel of the lug is further away from the mounting surface of the isolated stud. The flat side of terminal end (lug) must be down.

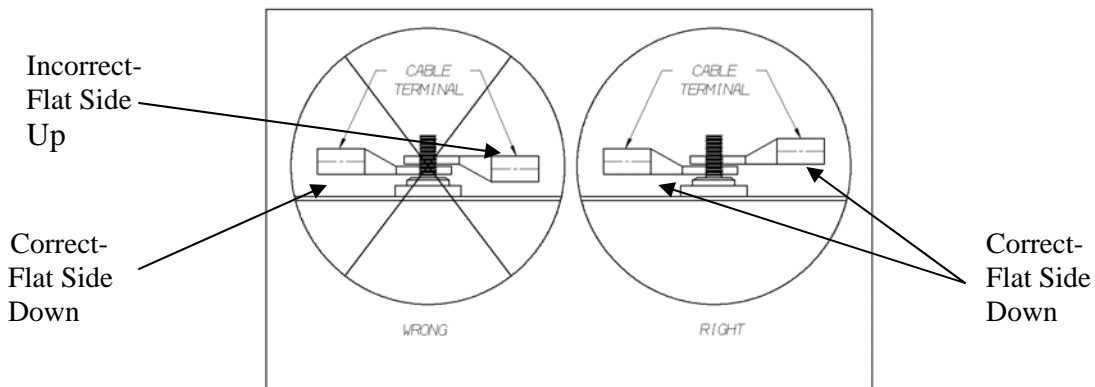

5. If the cables were installed incorrectly, remove the nut securing the cables. Then remove the cables and reinstall correctly per the diagram above. Make sure the terminal lugs are fanned out on the stud as opposed to directly on top of each other. Vice-grip pliers are recommended when turning incorrectly installed cable terminal lug to the correct orientation of flat side down.

**Caution: Do not grasp cable on insulation**

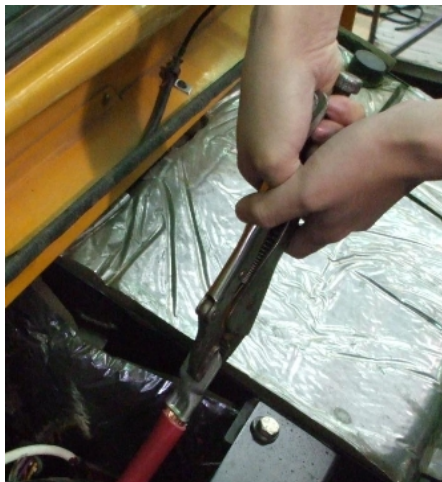

6. Secure the cables with the nut and torque to 12 to 15 ft-lbs.
7. Apply corrosion resistant coating (glyptal) as required to prevent corrosion.

R I O R W

R E C A L L C A M P A I G N



## INSPECTION OF POWER DISTRIBUTION UNIT (PDU)

8. Next, the Chassis Power Studs located behind the PDU must be checked. To gain access behind the PDU go inside the vehicle and do the following:
  - a. Remove the Power Distribution Unit (PDU) cover by unscrewing the two thumb screws, located at the top of each side of the cover.



- b. Remove the fasteners securing the PDU to the Driver's Control Module (DCM) and the fasteners securing the PDU to the floor.

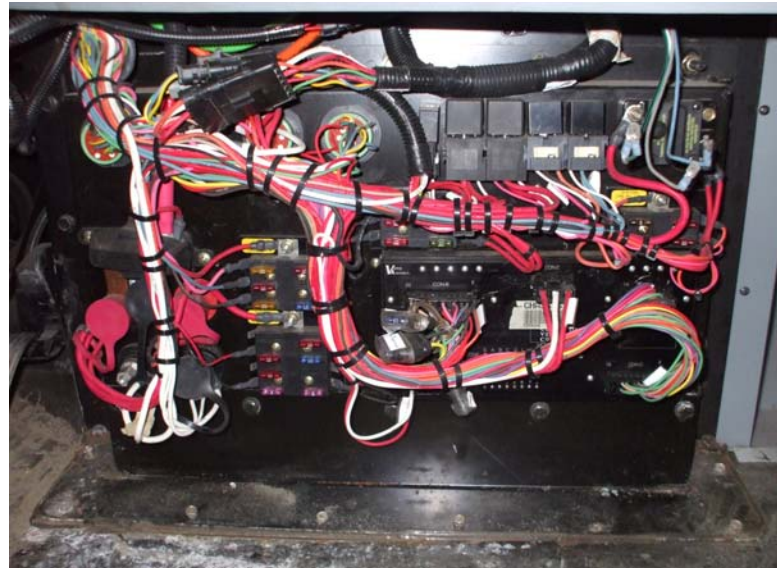



## Incorrect Power Cable Lug Orientation

# RECALL

- c. Carefully slide the right side of the PDU rearward far enough to access the wiring behind the engine.



- i. To gain access behind the PDU to inspect and possibly correct the cables, it may be necessary to cut the two cable ties securing cables to the PDU.

The upper cable tie is shown below.



R I O R W

R E C A L L C A M P A I G N



## Incorrect Power Cable Lug Orientation

# RECALL

- ii. To gain better access it may be necessary to disconnect the 4 Deutsch connectors.



9. Next, locate and inspect the two Power Studs below the 4 Deutsch connectors.

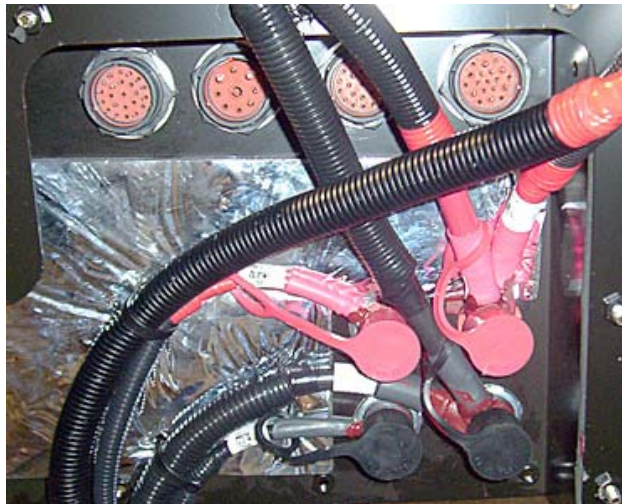

10. Remove the two red protective covers and inspect the electrical cable connections at the Power Studs.

Reference diagram at top of page six (6) for proper cable end installation.

ALL terminal lugs on each power stud should be oriented such that the barrel of the lug is further away from the mounting surface of the isolated stud. The flat side must be down.

If the cables were installed correctly, proceed to step 16 on page 6.

If cables **are not** installed correctly, follow steps 11 through 15.

R I O R W

R E C A L L C A M P A I G N



## Incorrect Power Cable Lug Orientation

# RECALL

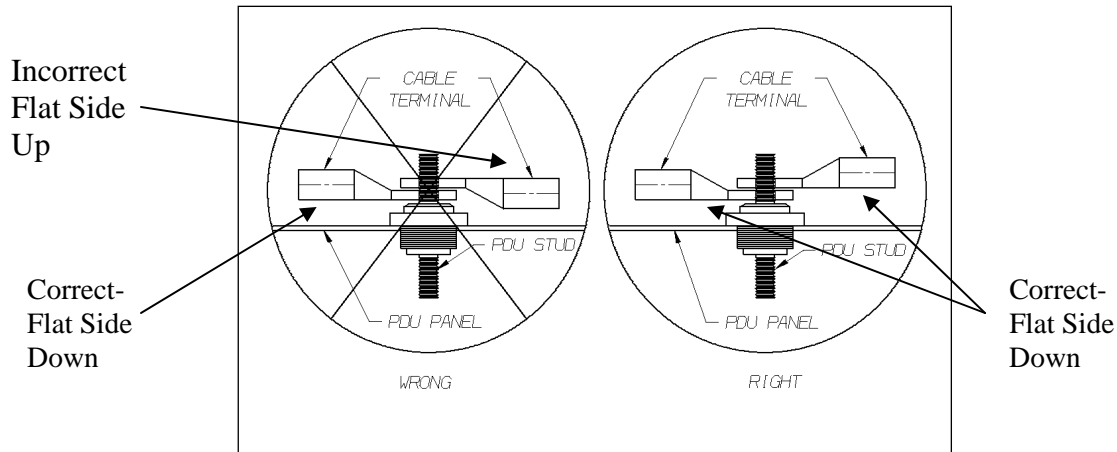

11. Remove the nut securing the cables. Then remove the incorrectly installed cables and reinstall correctly with flat side down. Make sure the terminal lugs are fanned out on the stud as oppose to directly on top of each other.
12. If needed, use vise grips to rotate cable so lug fits with flat side down. See photo on page 2.
13. Secure the cables with the nut and torque to 12 to 15 ft-lbs.
14. Apply corrosion resistant coating (glyptal) as required to prevent corrosion.
15. Reinstall the red protective covers.
16. While having access to this area, inspect ALL power cables for any evidence of contact with the rear of the engine, chaffing, or other damage. **Ensure clearance between power cables and any part of the engine is more than ½ inch.**

**If any damaged cables are found, contact Blue Bird Recall Administration for replacement cable(s).**

17. Reinstall the Power Distribution Unit (PDU).
  - a. Reconnect the 4 Deutsch connectors if they were removed.
  - b. Secure the power cables to the back of the PDU with Button Cable Ties, if they were damaged or removed.
  - c. Carefully slide the PDU back into position against the DCM.

**WARNING: Ensure that no wires are pinched at the Power Distribution Unit (PDU) when PDU is slid back into position.**

- d. Secure the PDU to the DCM and floor with the fasteners removed earlier.
  - e. Reinstall the Power Distribution Unit cover with the two thumb screws.
18. Close the engine hood. Reconnect batteries.

**[CAUTION] When reconnecting the batteries, connect the Negative cable last.**

19. The procedure is complete, and the bus may be returned to normal service.

RIORW

RECALL CAMPAIGN