

Reference:

ITB08-034b

Date:

September 9, 2008

VOLUNTARY RECALL CAMPAIGN 2004 – 2006 INFINITI QX56 AIR CONDITIONER CONDENSER FAN

This bulletin has been amended. The Claims Information has been changed.
Please discard previous versions of the bulletin.

CAMPAIGN ID #: PB080 – for Applied Vehicles built before March 17, 2005
PB076 – for Applied Vehicles built on or after March 17, 2005

NHTSA #: 08V-284

APPLIED VEHICLES: 2004 – 2006 QX56 (JA60)

Refer to Infiniti Net to confirm campaign eligibility and the correct campaign ID #.

INTRODUCTION

Infiniti is conducting a Voluntary Recall Campaign on certain Model Year 2004, 2005, and 2006 Infiniti QX56 vehicles:

- All vehicles manufactured from March 17, 2005 to August 21, 2006 are subject to this campaign.
- Model Year 2004 vehicles and Model Year 2005 vehicles manufactured before March 17, 2005 are included only if the air conditioning condenser fan was replaced after the vehicle was originally purchased using one of the affected replacement parts.

The air conditioning condenser fan motor in the subject vehicles was manufactured out of specification allowing for excessive water intrusion and inadequate drainage of moisture. If enough moisture accumulates in the motor, corrosion may occur, leading to increased temperature in the motor. Because of the motor's unique structure, this increased temperature could melt its wiring insulation and other plastic components and ultimately result in a fire. **To correct the issue, Infiniti will inspect, and as needed, install a thermal protector kit on the air conditioning condenser fan at no charge for parts of labor.**

Also, to ensure continued customer satisfaction with the air conditioning system in these vehicles, the condenser fan motor will be tested for excessive friction. If necessary, the motor will be replaced with a new one at no charge for parts of labor. (If a new motor is installed, the protector kit is not needed.)

IDENTIFICATION NUMBER

Infiniti has assigned identification numbers PB076 and PB080 to this campaign. PB076 or PB080 must appear on all communications and documentation of any nature dealing with this campaign.

- PB080 is for 2004 and 2005 vehicles built before March 17, 2005.
- PB076 is for 2005 and 2006 vehicles built on or after March 17, 2005.
- **Refer to Infiniti Net to confirm campaign eligibility and correct campaign ID #.**

DEALER RESPONSIBILITY

It is the dealer's responsibility to check Infiniti Net for the campaign status on each vehicle falling within the range of this voluntary safety recall which for any reason enters the service department. This includes vehicles purchased from private parties or presented by transient (tourist) owners and vehicles in a dealer's inventory. **Federal law requires that new vehicles in dealer inventory which are the subject of a safety recall must be corrected prior to sale. Failure to do so can result in civil penalties by the National Highway Traffic Safety Administration.** While federal law applies only to new vehicles, Infiniti strongly encourages dealers to correct any used vehicles in their inventory before they are retailed.

TABLE OF CONTENTS

Required Special Tools	3
Repair Overview (flow chart).....	4
Service Procedure.....	5
Procedure A: Identify Fan Type	5
Procedure B: Cooling Fan Motor Inspection	9
Comparison Chart: RPM to Fan Motor Voltage	15
Procedure C: Remove and Install or Replace the Condenser Fan Assembly	17
Procedure D: Install Protective Covering to Fan Motor and Harness	27
Procedure E: Install Maxi Fuse	38
Procedure F: Confirm Fan Operation	42
Parts Information	43
Claims Information	44
Owner's Letter	45

Required Special Tools:

- Any of these special tools can be ordered from TECH-MATE at 1-800-662-2001.

Fluke 115 Digital Multimeter:

- Part number for Fluke Multimeter – 624-FLK-115



Fan Motor Tester: Part of test kit J-49489

- Part number for Fan Motor Tester – J-49489-1



Phototach (OTC 3660) Digital Tachometer: Part of test kit J-49489

- Part number for Phototach – 3660

WARNING: Do not shine or point the red light beam from this tool into anyone's eyes (including your own).



Reflective Paint: Part of test kit J-49489

- Part number for reflective paint – 550197

Applicator: Part of test kit J-49489

- Part number for Applicator (100 pack) - 550223



Repair Overview

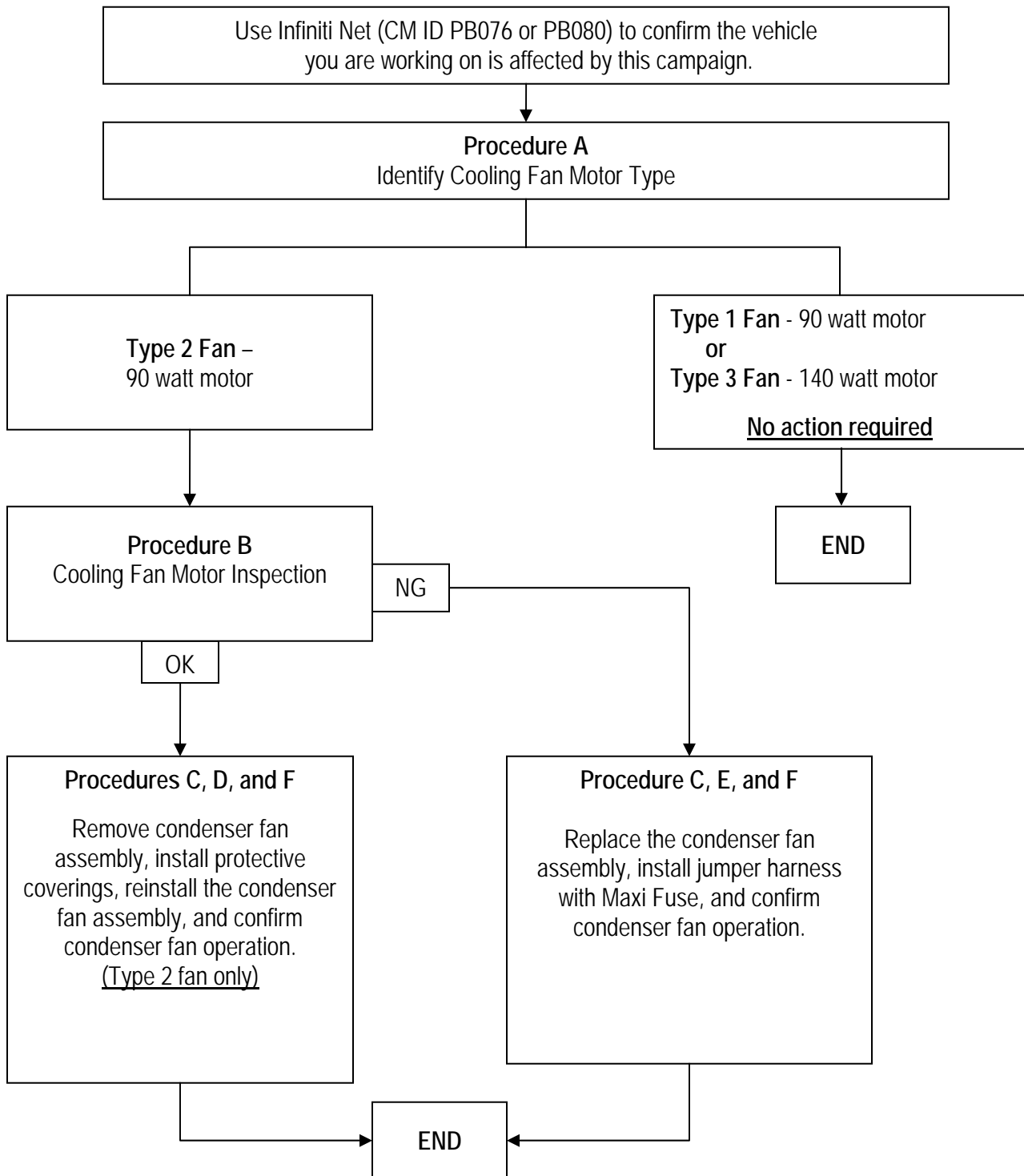

SERVICE PROCEDURE

RECOMMENDATION: If this is your first time performing this Service Procedure, it is recommended that you view the video clip on ASIST before starting. To view the video clip, open the bulletin on ASIST and select "Video" at the bottom of the screen. To view the video full screen, right click the center of the video screen and select "Full Screen".

PROCEDURE A: Identify Fan Type

1. Look in the lower area of the front fascia.

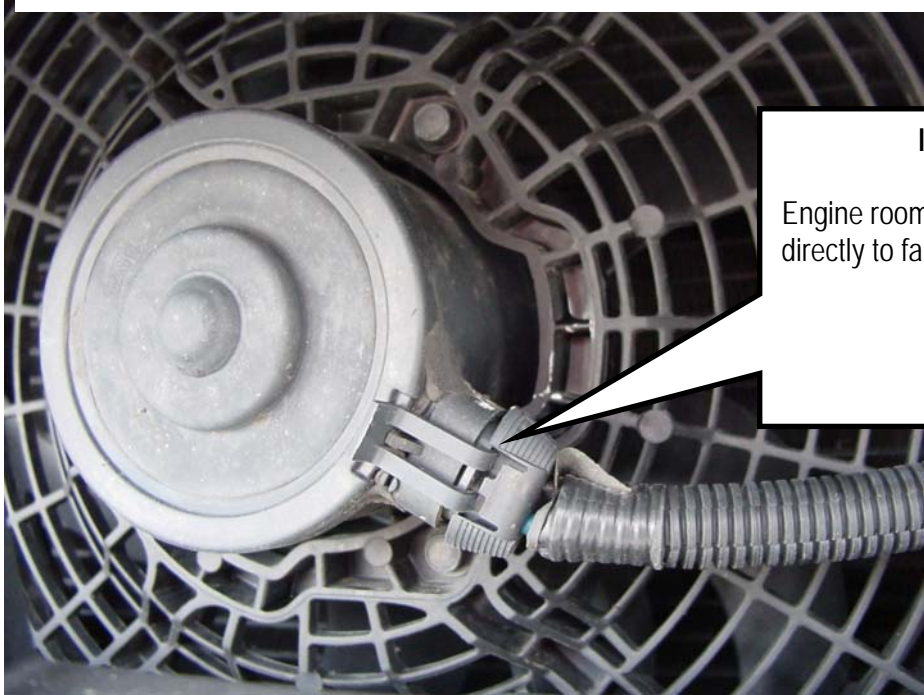

Figure A-1

2. Use the photos on the next 3 pages to identify the fan type.

Type 3 Fan - 140 watt motor

No action required



Identification

Engine room harness connects directly to fan motor.

Figure A-2

Type 1 Fan - 90 watt motor

No action required

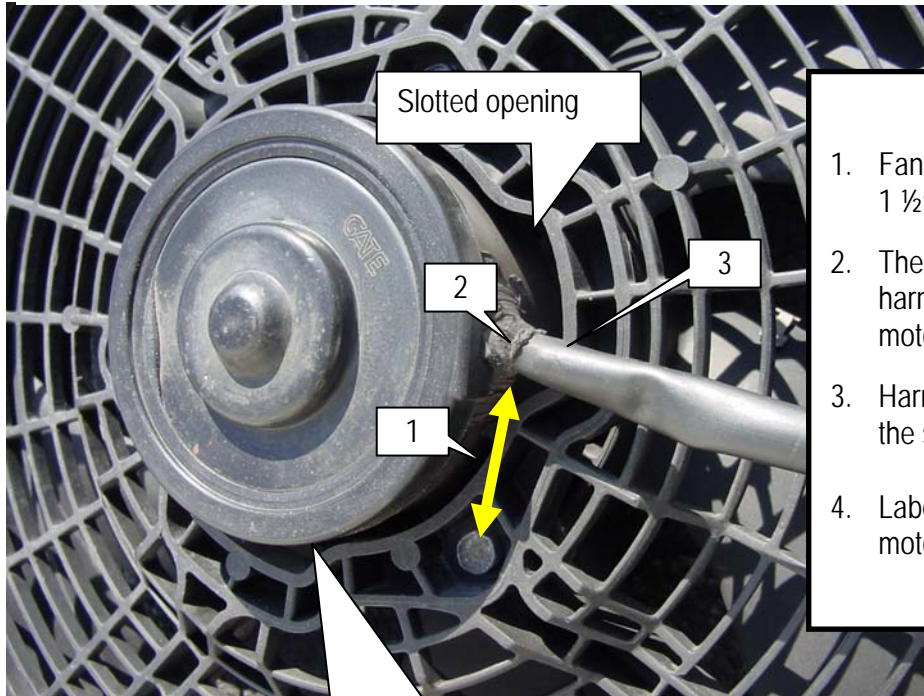

Identification:

1. Fan motor harness position is 1 ½" from mounting bolt.
2. There are no exposed wires. Plastic harness cover goes right up to the motor.
3. Harness goes across the lower part of the slotted opening.
4. Label on the lower side of the fan motor has the word "GATE".

Figure A-3

4: Label has the word "GATE"



Type 2 Fan - 90 watt motor
Go to Procedure B - Cooling Fan Motor Inspection

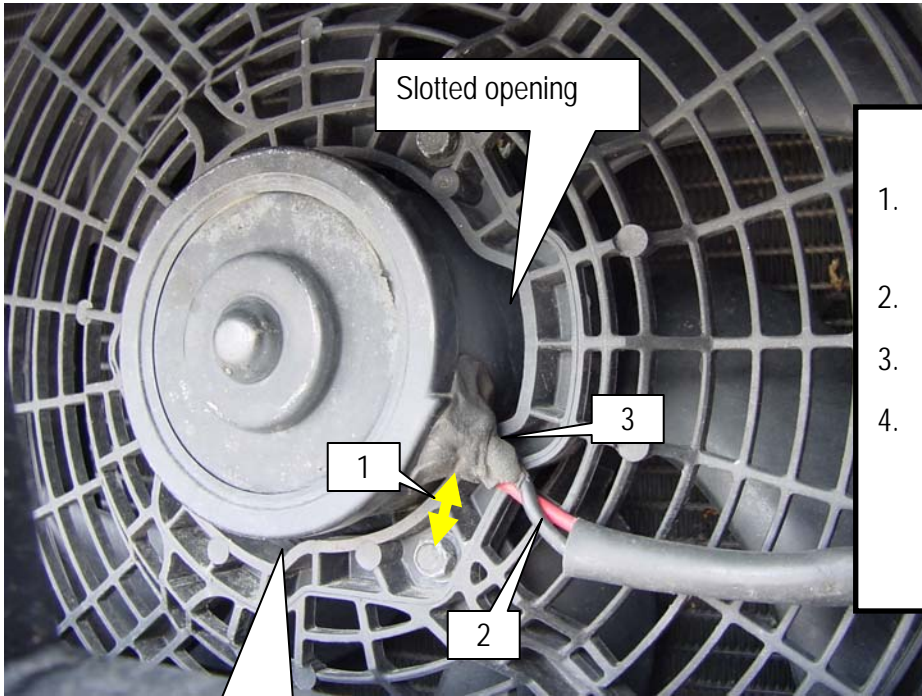

- Identification:**
1. Fan motor harness position is ½ inch from mounting bolt.
 2. Red and Black wires are exposed.
 3. Wire harness is below slotted opening.
 4. Label on the lower side of the fan motor does not have the word "GATE".

Figure A-4



PROCEDURE B: Cooling Fan Motor Inspection

RECOMMENDATION: If this is your first time performing this Service Procedure, it is recommended that you view the video clip on ASIST before starting. To view the video clip, open the bulletin on ASIST and select "Video" at the bottom of the screen. To view the video full screen, right click the center of the video screen and select "Full Screen".

1. Inspect the wires near the condenser fan motor:

- Make sure there is no damage to the wire insulation and the wires are in good condition.
- **If the wires are damaged** (cracked or missing insulation), STOP; no more testing is needed. Go to Procedure C on page 17 and replace the condenser fan assembly.

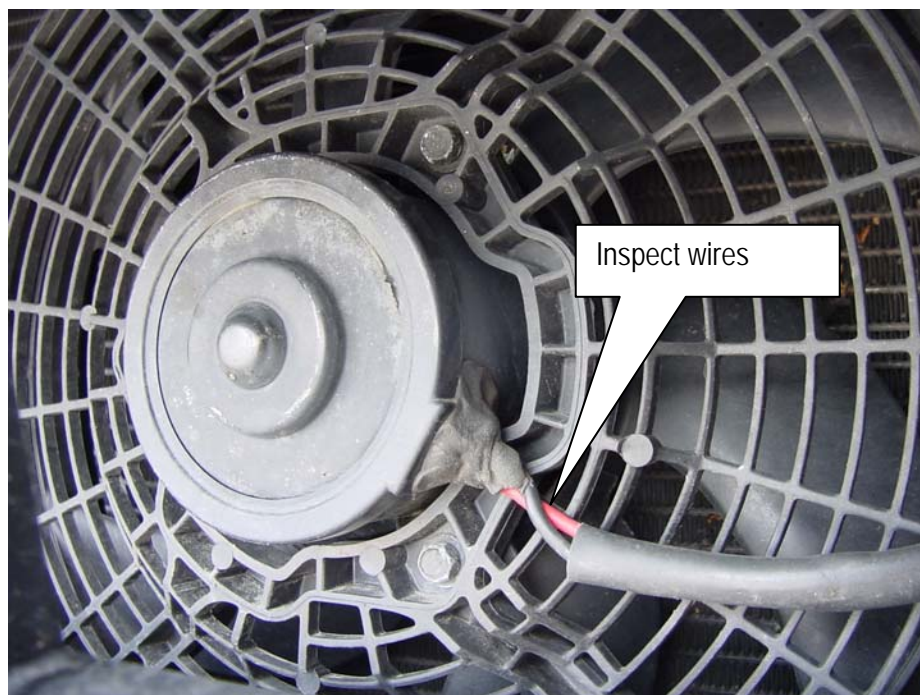

Figure B-1

2. Disconnect the condenser fan electrical connector.

IMPORTANT: Do not lose the rubber seal from inside the connector.

3. Shake the bottle of reflective paint and open an applicator.

- Reflective paint and applicator are part of special tool kit J-49489.
- Additional reflective paint and applicators can be ordered from TECH-MATE at 1-800-662-2001.

4. Paint a “dime sized” area on the outer portion of one fan blade.

- Make sure the painted area is completely filled in (no unpainted spots or thin paint in the dime sized area).
- Allow the paint to dry—about 5 minutes.



Figure B-2

5. Before connecting to the vehicle battery, make sure the Fan Motor Tester is switched OFF.



Figure B-3

6. Connect the Fan Motor Tester and the Fluke Digital Multimeter (using the fluke meter test leads) as follows (see Figure B-4):
 - Connect Fan Motor Tester harness connector to the condenser fan.
 - Connect Fan Motor Tester to the vehicle battery; Red clamp to + (positive) / Black clamp to – (negative).
 - Connect the Fluke digital multimeter to the MOTOR VOLTAGE test ports on the Fan Motor Tester; V+ red probe to POS / COM black probe to NEG.

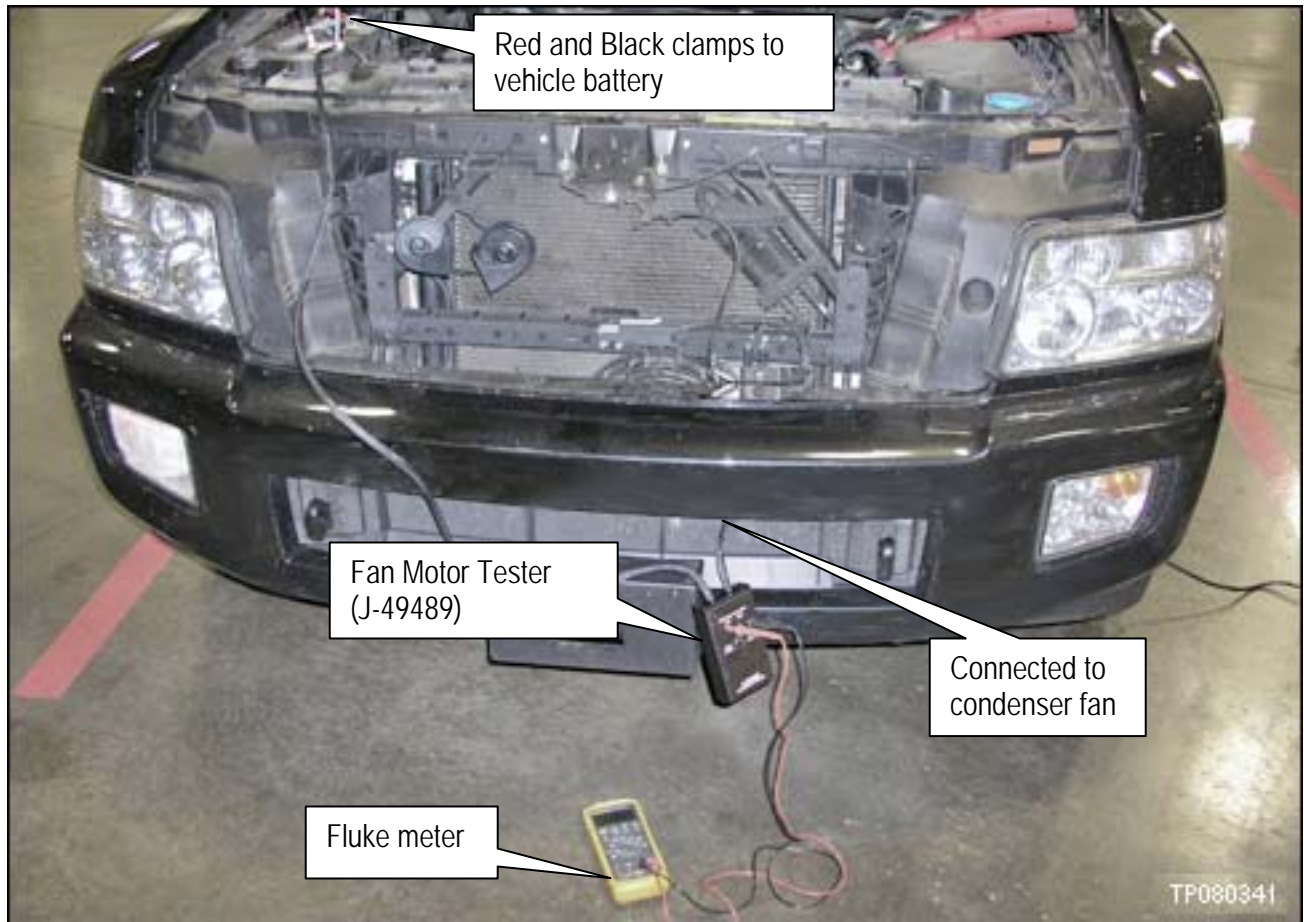

Figure B-4

NOTE: When connected as above with the Fan Motor Tester switched OFF, the LED on the switch will illuminate green; this indicates the tester has battery power.

Testing Condenser Fan Motor

CAUTION: Make sure there are no objects in the way of the fan blades. Keep all objects away from directly contacting the fan blades when the fan motor is running.

7. Switch the Fan Motor Tester to ON, observe the fan operation for 3 to 4 seconds and then turn the Fan Motor Tester OFF:
 - If the fan turned and operated freely; go to step 8.
 - If the fan did not operate freely; this indicates the fan motor is NG and must be replaced. No further testing is needed; go to Procedure C on page 17.

8. Prepare the Fluke Meter and the Phototach Digital Tachometer for the next test as follows.
 - a. Switch the Fluke Meter to read DC Volts.
 - b. Remove the Phototach Digital Tachometer from its case and have it ready to check the fan RPM.

NOTE: It is important that readings from these two meters be read and recorded at the same time in the next test.



Figure B-5

Fan RPM

Fan Motor Voltage



Figure B-6

c. Practice using the Phototach Digital Tachometer as follows:

1. Do not turn the fan motor tester ON at this time.
2. Press and hold the TEST button on the Phototach Digital Tachometer.

WARNING: Do not shine or point the red light beam from the Phototach Digital Tachometer into anyone's eyes (including your own).

3. Hold the digital tachometer about 4 inches away from the condenser fan.
4. Aim the red beam at the painted area on the fan blade.
 - The beam should be aimed between / through the slots in the fan shroud.

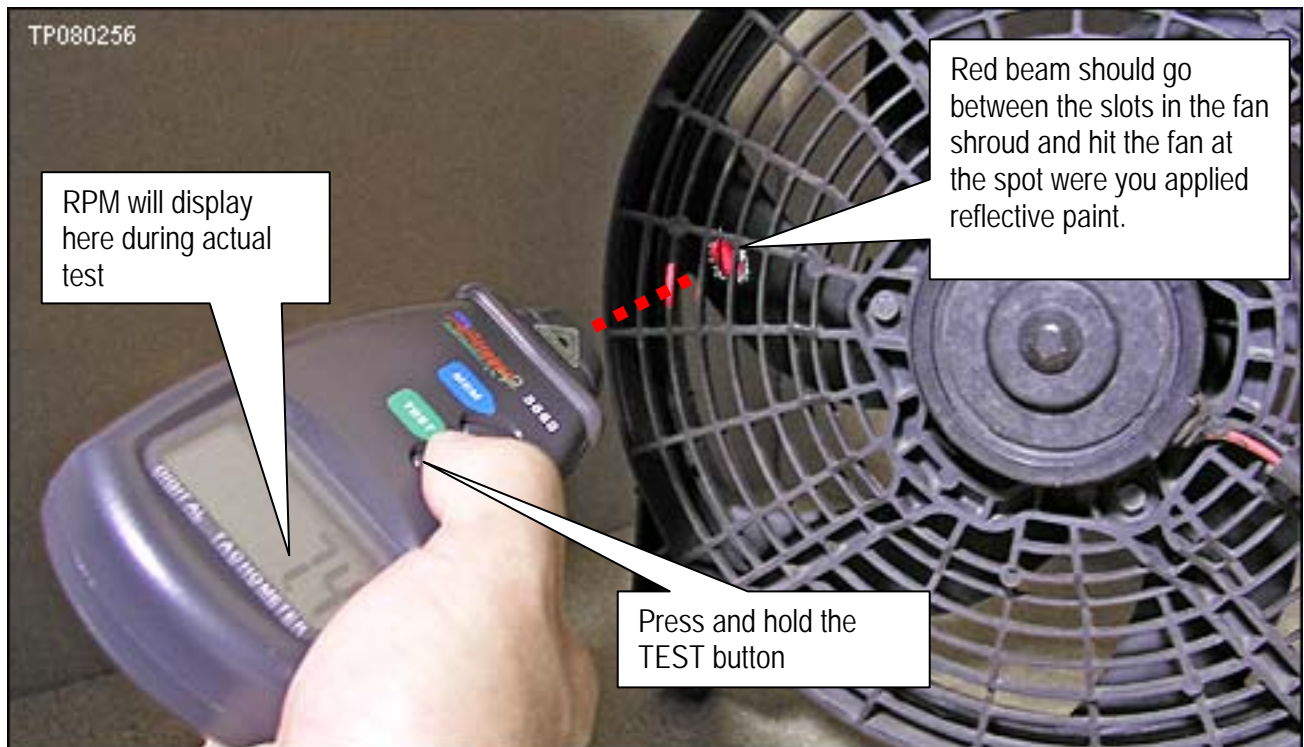

Figure B-7

9. Measure the fan motor speed (RPM) and fan motor voltage as follows:

a. Turn the Fan Motor Tester ON.

NOTE: In the ON position, the LED light on the switch will illuminate yellow.

b. Press and hold the TEST button on the Phototach Digital Tachometer.

WARNING: Do not shine or point the red light beam from the Phototach Digital Tachometer into anyone's eyes (including your own).

b. Hold the digital tachometer about 4 inches away from the condenser fan.

c. Aim the red beam at the painted area on the fan blade.

- The beam should be aimed between / through the slots in the fan shroud.



Figure B-8

d. Observe the RPM reading on the tachometer and the volt reading on the Fluke Meter.

IMPORTANT: The RPM and voltage reading should be observed at the same time with the fan motor running.

10. Record / write down the RPM and Volt readings you observed in step 9 d.

NOTE: Pressing the MEM (memory) button on the Phototach Digital Tachometer will display the last RPM measurement.

11. Switch the Fan Motor Tester to OFF.

12. Disconnect the testers from the vehicle.

15. Determine your next steps as follows:

If the fan motor is OK:

- a. **Remove** the Condenser Fan Assembly – Procedure C steps 1 through 15.
- b. Install the Condenser Fan Motor Protective Coverings – Procedure D.
- c. Reinstall the Condenser Fan Assembly – Procedure C steps 16 through 31.
- d. Confirm Condenser Fan Motor operation – Procedure F.

If the fan motor is No Good:

- a. **Replace** the Condenser Fan Assembly – Procedure C.
- b. Install the Max Fuse – Procedure E.
- c. Confirm Condenser Fan operation – Procedure F.

PROCEDURE C: Remove and Install, or Replace the Condenser Fan Assembly

1. Write down the radio station presets.

Presets	1	2	3	4	5	6
A						
B						
C						

2. Turn the ignition OFF and disconnect the negative battery cable.
 - Wait at least 3 minutes before working with any airbag components.

3. Remove 2 clips from under the front fascia.

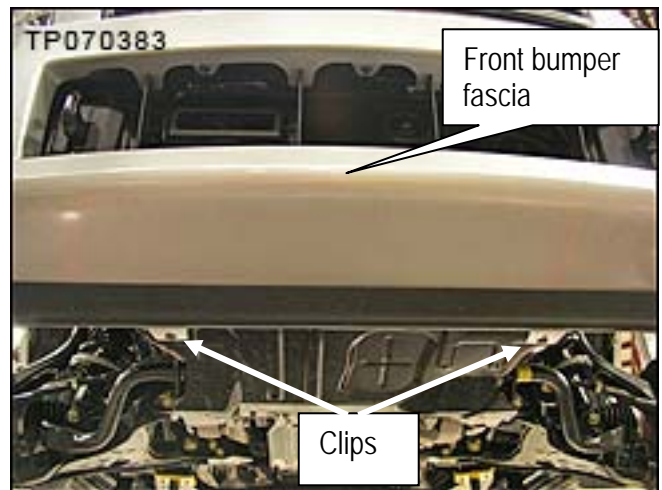

Figure C-1

4. Remove both headlamp finishers (left and right); 3 clips on each finisher.

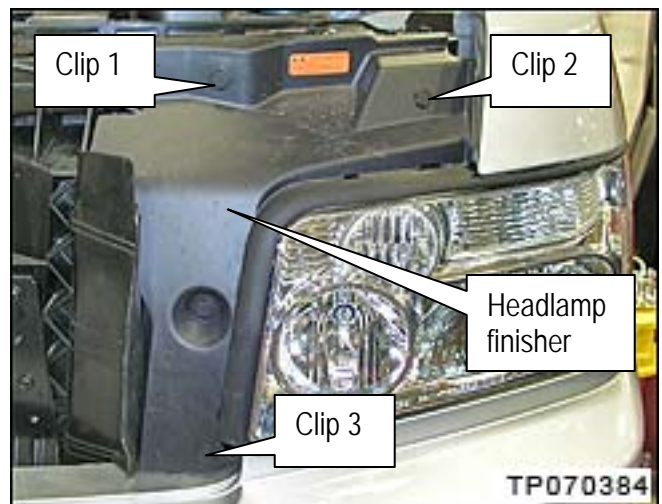

Figure C-2

- Remove 6 clips from the bumper fascia (shown below).
- Remove 4 bolts from bumper fascia brackets (shown below).

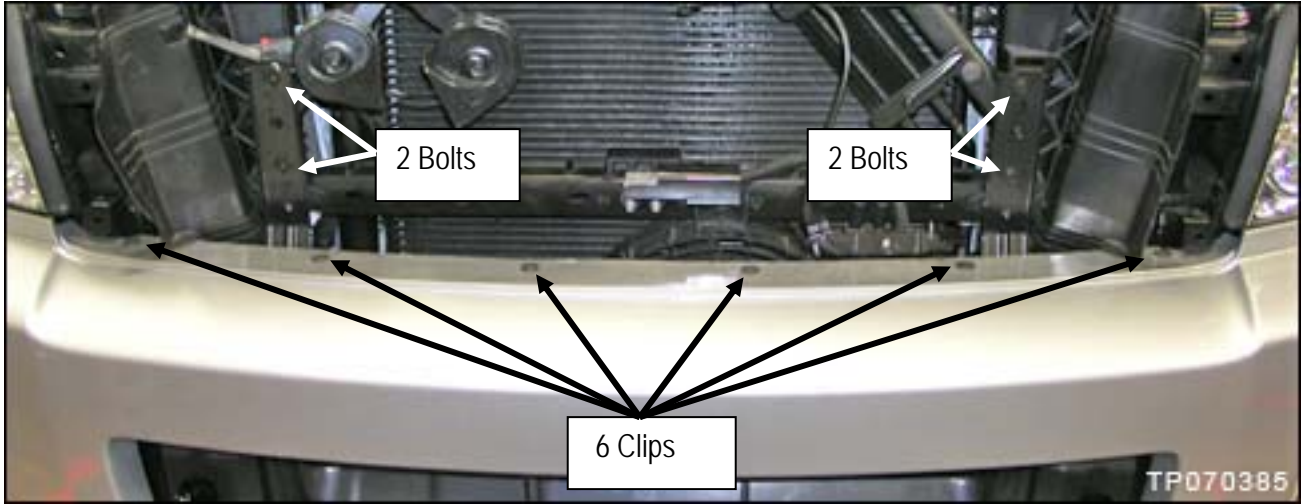

Figure C-3

- Remove 2 nuts from the hood latch and position it out of the way.

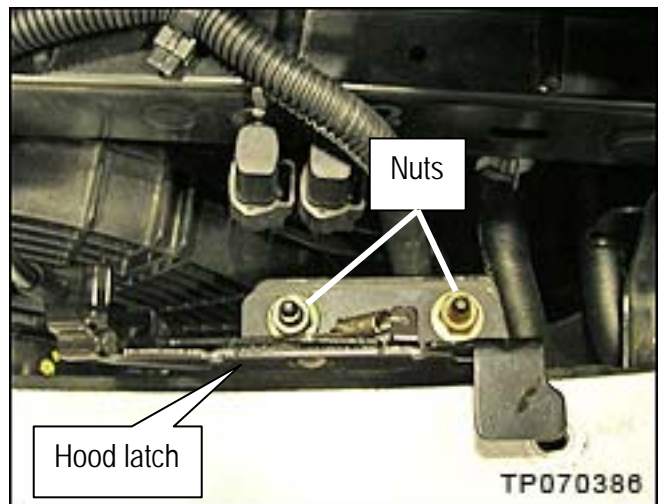

Figure C-4

8. Remove 6 screws from the front of the fender protectors; 3 on each side (Left and right).

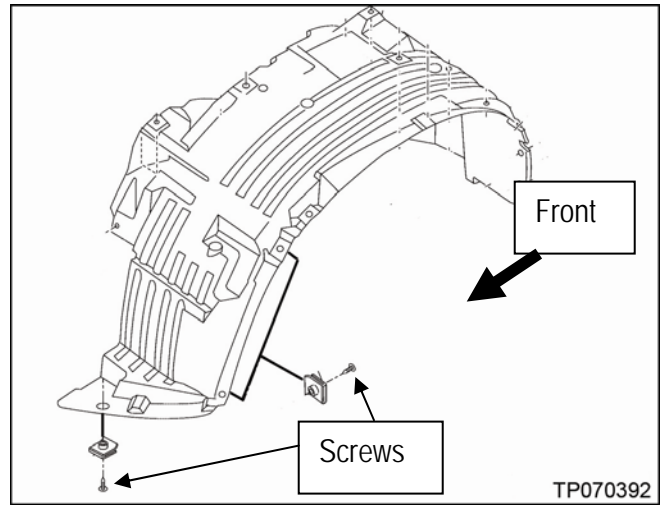

Figure C-5

9. Remove 2 corner bumper fascia bolts (1 on each side).

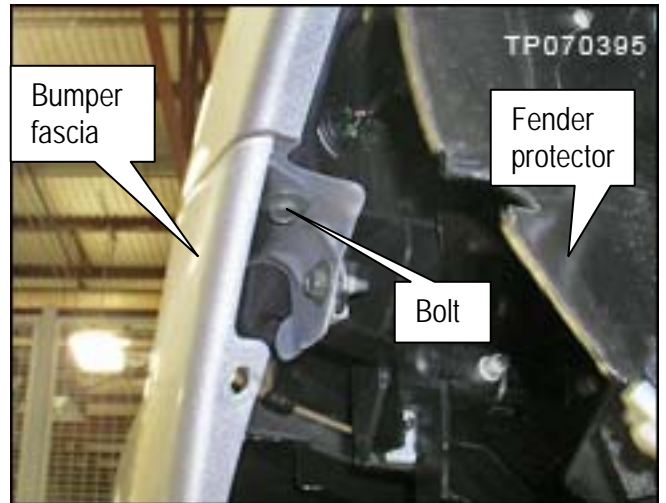

Figure C-6

10. Disconnect the fog lamps (both sides).



Figure C-7

11. Remove the 4 bumper fascia bolts shown below.

- Reach up behind the fascia to remove the bolts.



Figure C-8

12. Use 2 people to lift off the bumper fascia and set it out of the way.

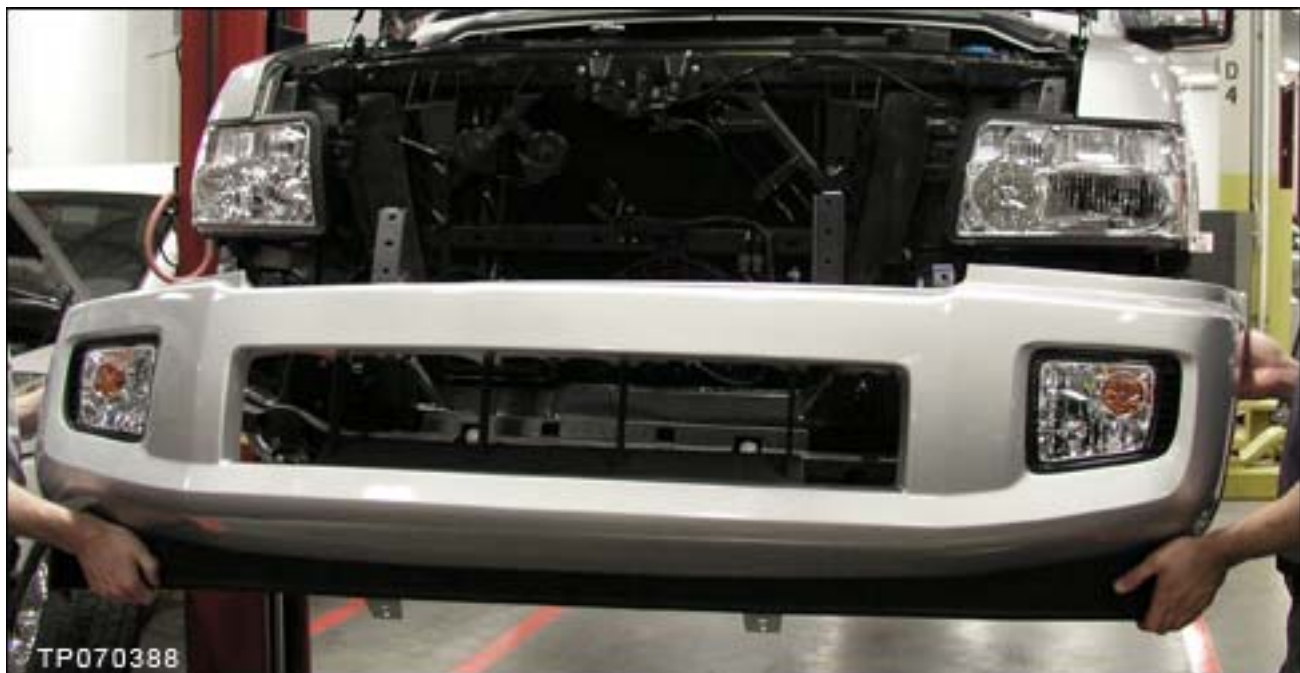

Figure C-9

13. Make sure the condenser fan electrical connector is disconnected.

IMPORTANT: Do not lose the rubber seal from inside the connector.

14. Remove the condenser fan mounting bolt.
15. Remove the condenser fan.

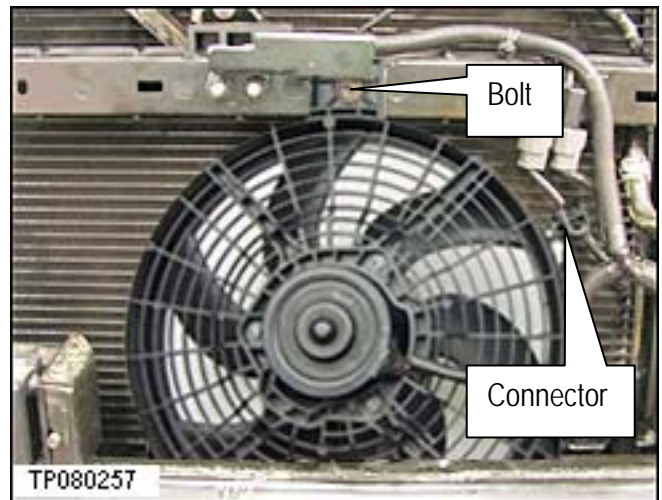

Figure C-10

If your fan motor tested OK in Procedure B:

- a. Go to Procedure D on page 27 to install the Fan Motor Protective covers.
 - Protective Covering Kit is listed in the Parts Information.
- b. Return here for installation of the fan assembly – starting on the next page.

If your fan motor tested NG in Procedure B:

- a. Install the jumper harness on the new fan motor as show on the next page.
 - New fan assembly and Jumper harness are listed in the Parts Information.
- b. Continue with this procedure to install the new fan motor.

Jumper harness installation on NEW 140 watt fan assembly

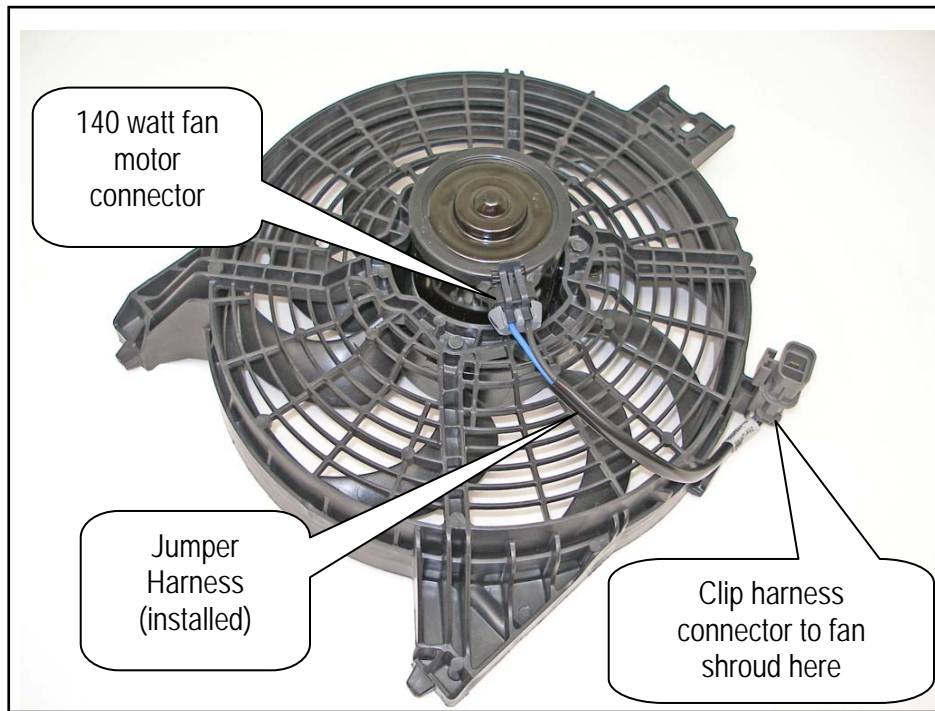

Figure C-11

Install Condenser Fan Assembly

16. Install the condenser fan.
17. Install the condenser fan mounting bolt.
18. Make sure the Rubber Seal is inside the condenser fan electrical connector and then connect the connector.

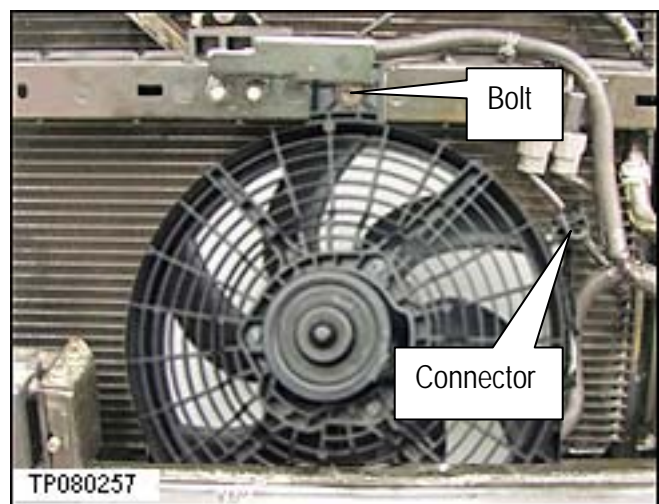

Figure C-12

19. Use 2 people to lift and install the bumper fascia.

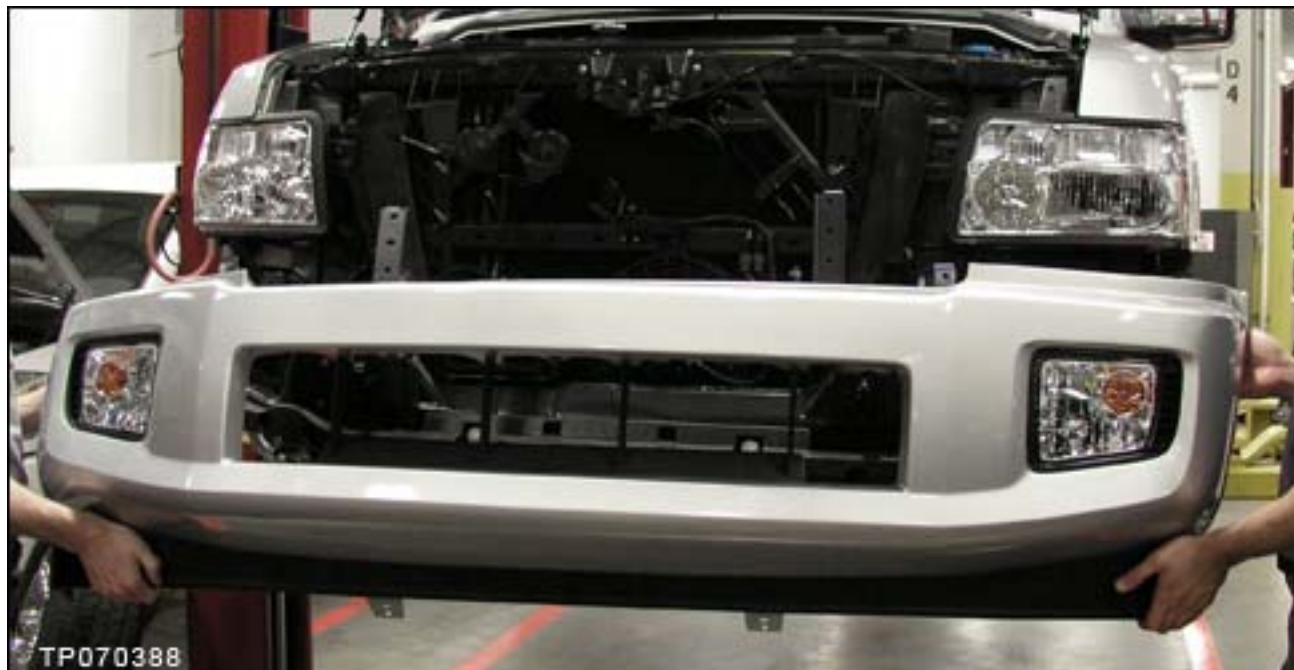

Figure C-13

20. Install the 4 bumper fascia bolts shown below.

- Reach up behind the fascia to install the bolts.



Figure C-14

21. Connect the fog lamps (both sides).



Figure C-15

22. Install 2 corner bumper fascia bolts (1 on each side).

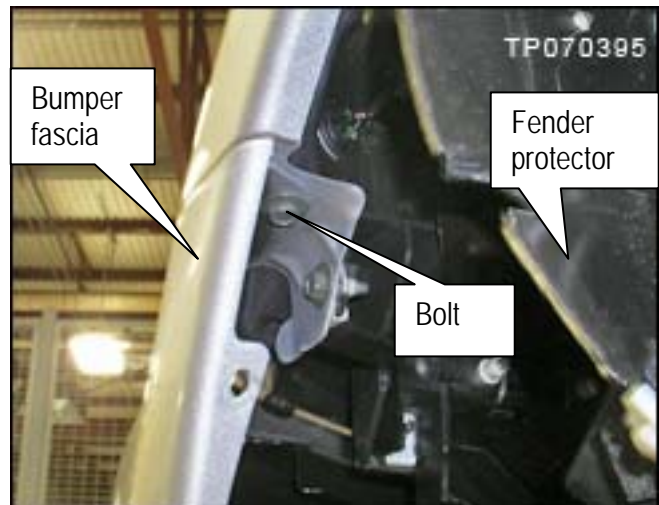

Figure C-16

23. Install 6 screws from the front of the fender protectors; 3 on each side (Left and right).

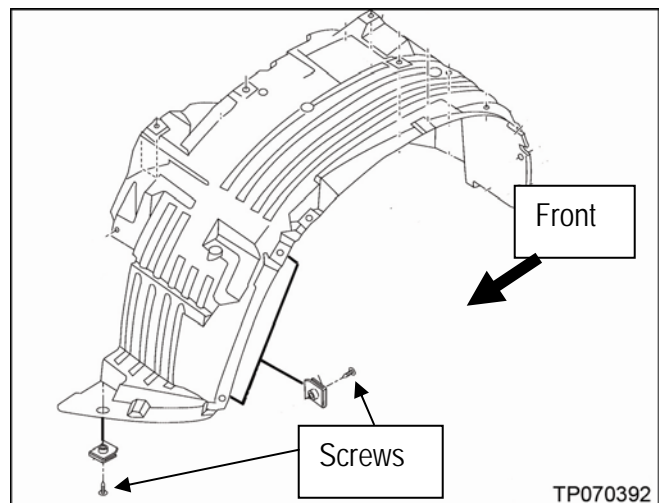

Figure C-17

24. Install 2 nuts for the hood latch.

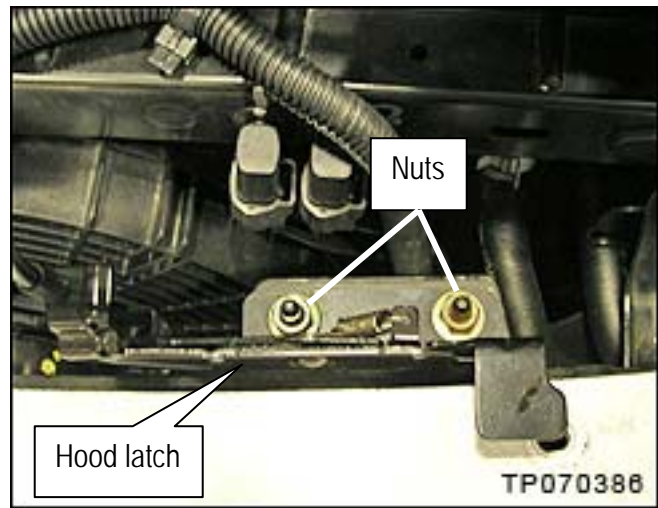

Figure C-18

25. Install 6 clips for the bumper fascia (shown below).

26. Install 4 bolts for the bumper fascia brackets (shown below).

Torque: 9.6 N.m (0.97 kg-m, 85 in-lb)

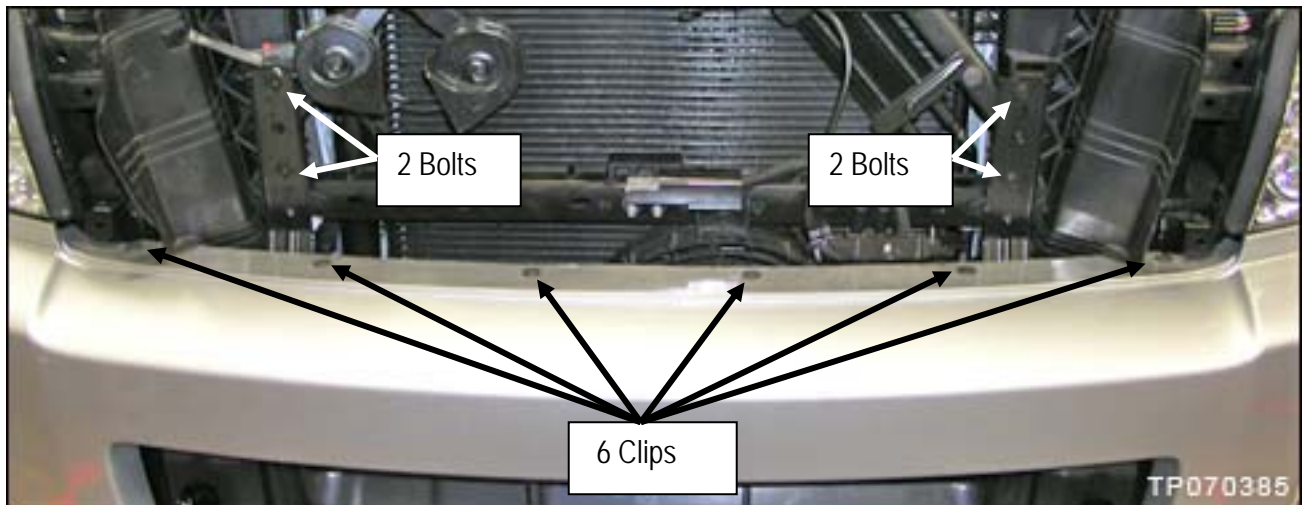

Figure C-19

27. Install both headlamp finishers (left and right); 3 clips on each finisher.

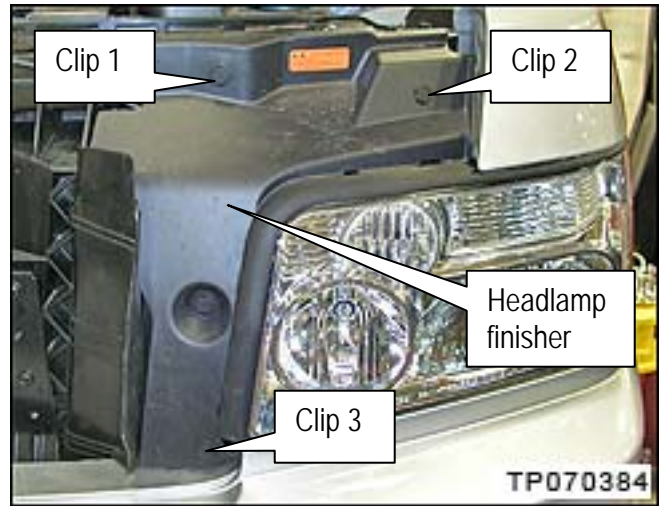

Figure C-20

28. Install 2 clips under the front fascia.

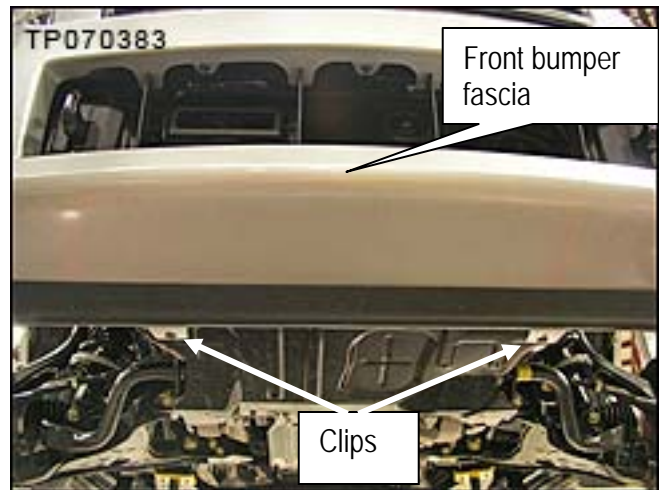

Figure C-21

If you have installed a NEW fan, skip steps 29 – 32 and go to Procedure E on page 38.

29. Reconnect the Negative battery cable.

30. Reset the radio station presets.

31. Reset the clock.

32. Go to Procedure F on page 42.

PROCEDURE D: Install Protective Coverings (Only for Type 2—90 Watt—Fan Motors That Tested OK)

RECOMMENDATION: If this is your first time performing this Service Procedure, it is recommended that you view the video clip on ASIST before starting. To view the video clip, open the bulletin on ASIST and select “Video” at the bottom of the screen. To view the video full screen, right click the center of the video screen and select “Full Screen”.

1. Remove the fan motor from the shroud as follows:
 - a. Disconnect the harness connector from the shroud.
 - b. Disconnect the harness from the shroud clip.
 - c. Remove the fan motor bolts x 3.
 - Discard the bolts; they will not be reused.
 - d. Carefully separate the motor from the shroud:
Don't damage the fan harness.

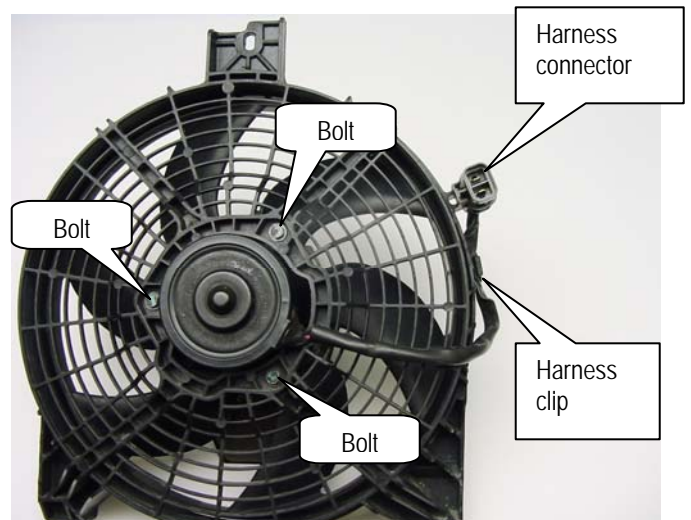

Figure D-1

2. Thoroughly clean all dirt and debris from the top and sides of the fan motor and the fan motor harness.
 - Use a locally approved brake cleaner and a clean rag.
 - The areas indicated must be completely clean to insure proper adhesion of the self adhesive protectors.

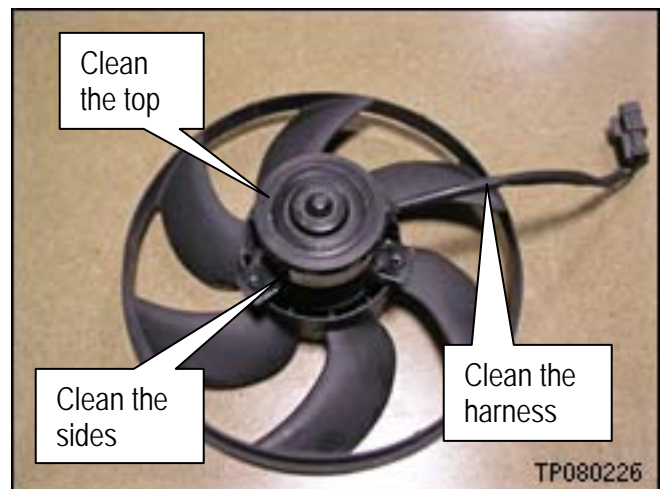

Figure D-2

NOTE: You may see clips (fan balance weights) on the fan blades. **DO NOT** move or remove the fan balance weights.



Figure D-2A

In the next few steps you will be installing these four self adhesive protectors.

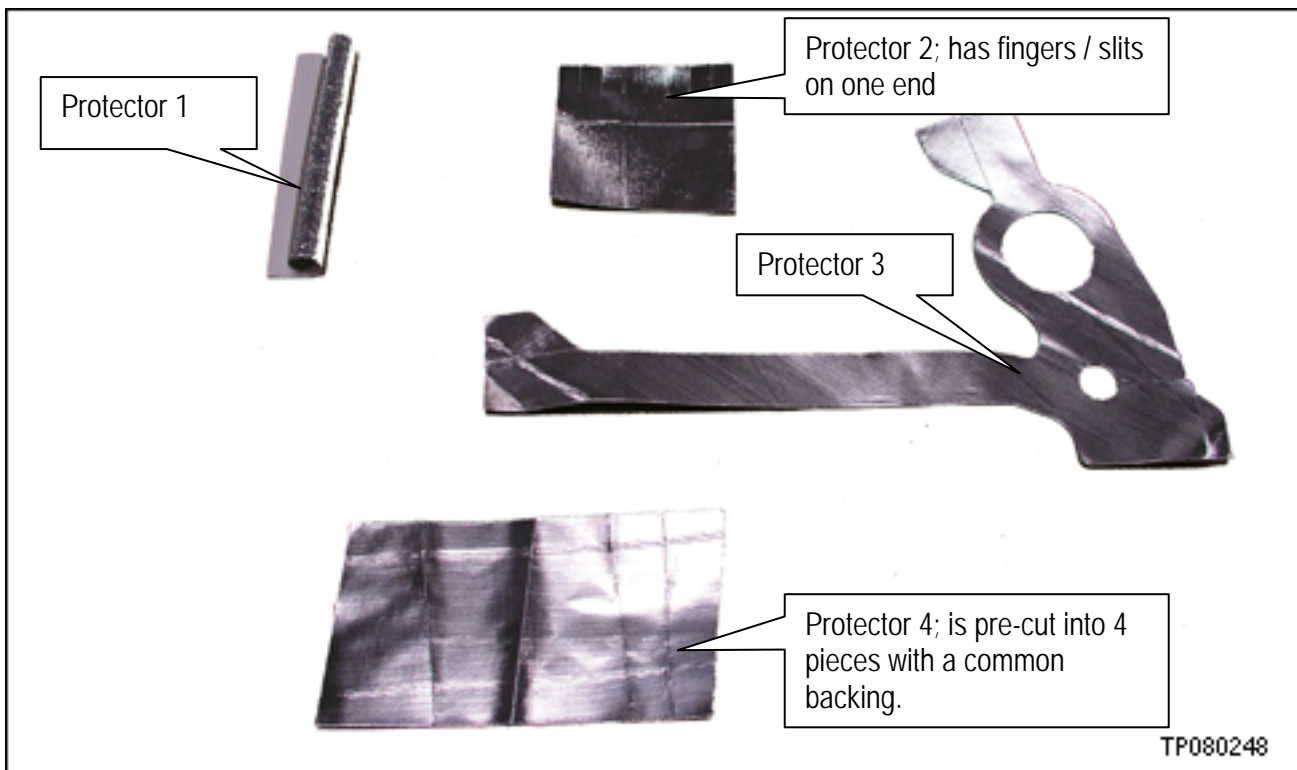

Figure D-3

NOTE: Make sure your hands are completely clean. Dirt and oil on your hands can contaminate adhesive material and reduce its adhesion.

3. Install **Protector 1** around the fan harness:
- Wrap / roll the protector tightly around the harness.
 - While holding the protector rolled tightly, remove the adhesive backing and secure the protector.

NOTE: The protector should slide on the harness.



Figure D-4

4. Remove the adhesive backing from **Protector 2** and install it around protector 1:

- Fingers / slits on protector 2 must be facing the fan motor.
- Align the bottom of protector 2 fingers with the end of protector 1.

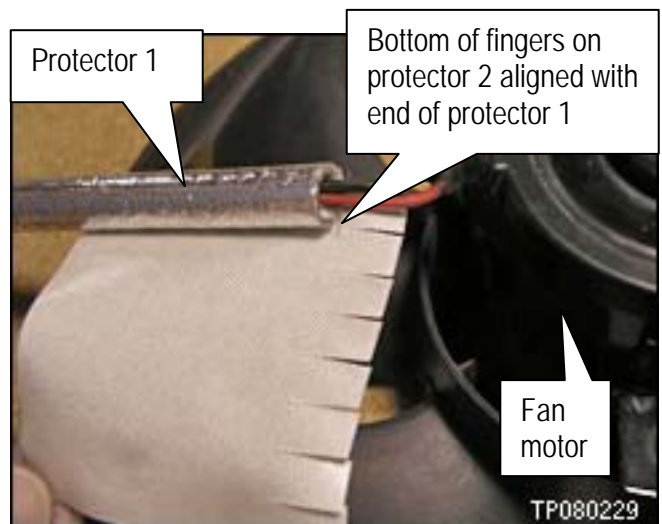

Figure D-5

- Wrap protector 2 around protector 1 and fold the fingers back as shown.



Figure D-6

5. Slide protector 2 against the fan motor and press / stick the fingers to the fan motor as shown.
 - Make sure to press and smooth the fingers so they are completely stuck to the fan motor.



Figure D-7

6. Remove the adhesive backing from **Protector 3** and stick it to the fan motor as shown.
 - Make sure the harness is routed through the harness hole in Protector 3. (Refer to Figure D-8A.)



Figure D-8

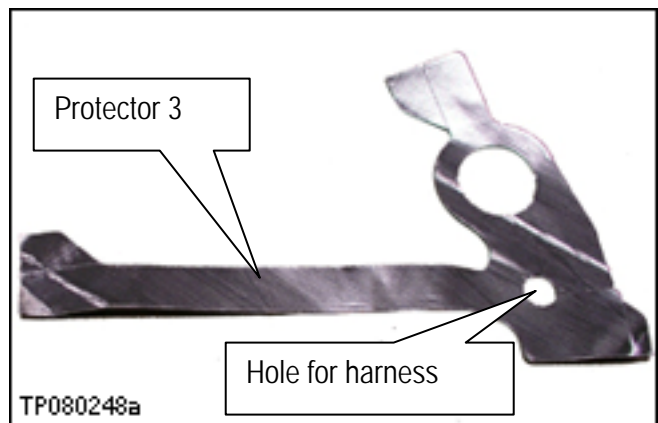

Figure D-8A

7. Fold and stick protector 3 to the top of the fan motor as shown.

Fold and stick the flap shown in Figure D-9 to the side of the fan motor.

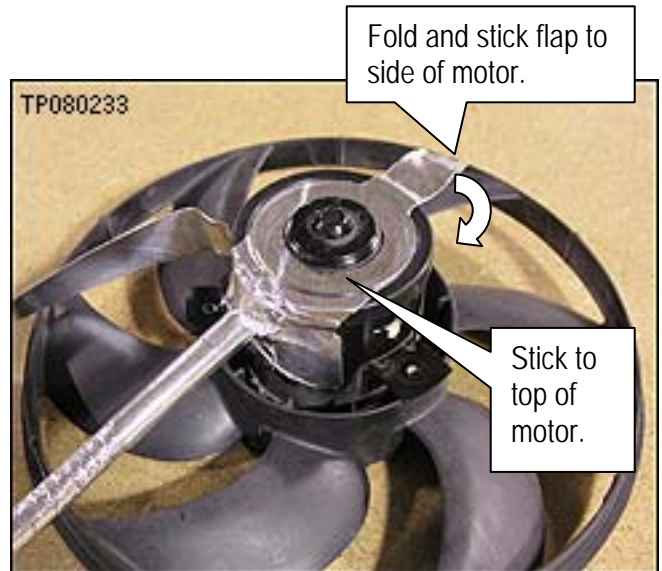

Figure D-9

8. Wrap the long strip of protector 3 completely around the motor.



Figure D-10

9. Press and smooth all parts of protector 3. Make sure it is completely stuck to the fan motor.
 - Pay special attention to the area shown in Figure D-11. Make sure there is good adhesion in this area.



Figure D-11

NOTE: The large support ribs on the fan shroud are labeled 1 o'clock, 5 o'clock, 7 o'clock, and 11 o'clock for reference when installing parts on to the fan shroud.

10. Thoroughly clean all dirt and debris from the fan shroud between the 1 o'clock and 5 o'clock ribs (see Figure D-12).

- Use a locally approved brake cleaner and a clean rag.

11. Install Protector 4 on the fan shroud.

- Remove 1 of the 4 sections from protector 4 adhesive backing.
- Stick the 1st section next to the 5 o'clock support rib.

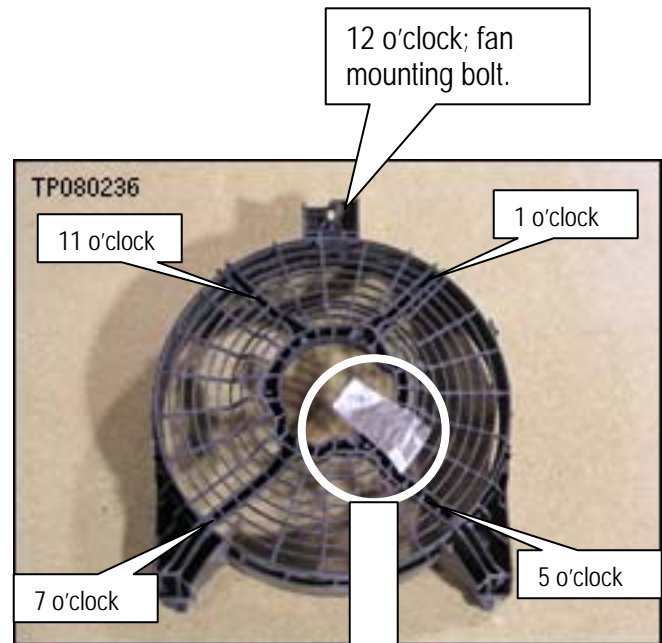

Figure D-12

Fold and stick under the shroud

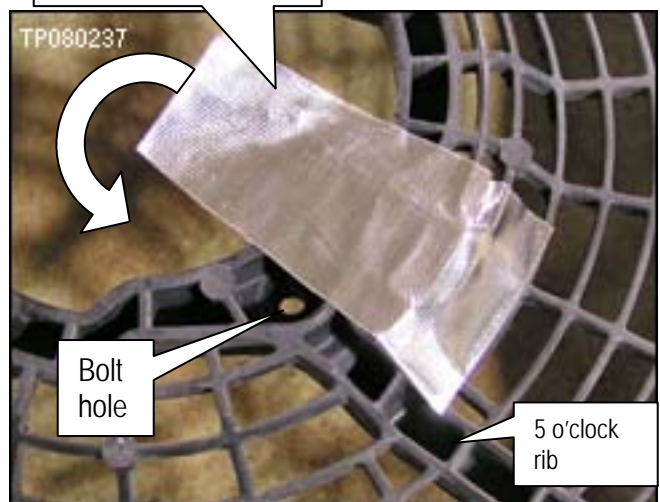

Figure D-13

- Align the protector along the 5 o'clock rib as shown.
- Don't cover up the bolt hole.
- Fold and stick the protector under the shroud.

c. Stick the 2nd piece of protector 4 on the fan shroud as shown.

- Overlap the 2nd piece on top of the 1st piece at the spot shown.
- Overlap about 10 mm (¼ inch) but not less than 5 mm (1/8 inch).
- Fold and stick the protector under the shroud.

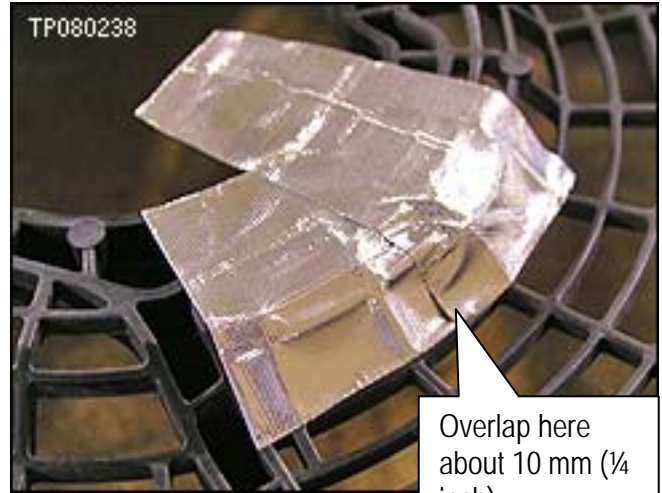

Figure D-14

d. Install the 3rd piece in the same manner as the 2nd piece.

e. Install the 4th piece of Protector 4 as shown.

- Align the protector along the 1 o'clock rib as shown.
- Don't cover up the bolt hole.
- Overlap the 4th piece on top of the 3rd piece at the spot shown.
- Overlap must be at least 5 mm (1/8 inch).
- Fold and stick the protector under the shroud.

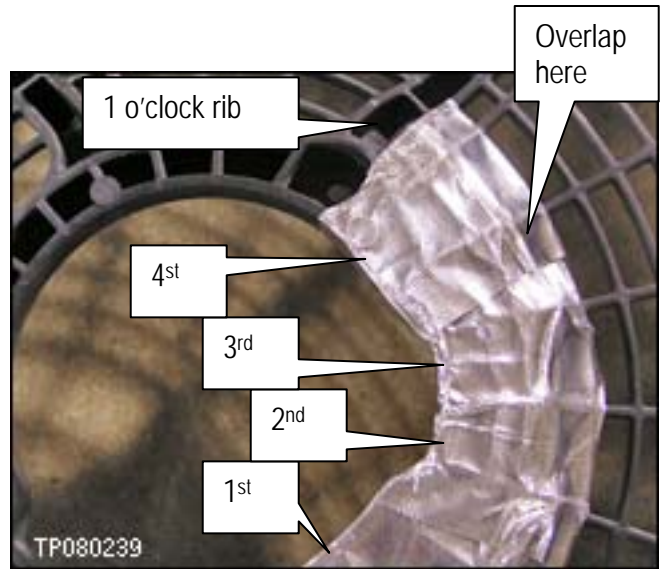

Figure D-15

12. Press and smooth all parts of protector 4. Make sure it is completely stuck to the fan shroud.

13. Install the motor in the shroud with the harness in the correct location (about 4 o'clock) as shown in Figure D-16.

- Use new bolts from the Fan Protector Kit. Bolt torque: 4.5 N.m (0.45, kg-m, **40 in-lb**).
- Mount the harness connector and clip the harness in place.

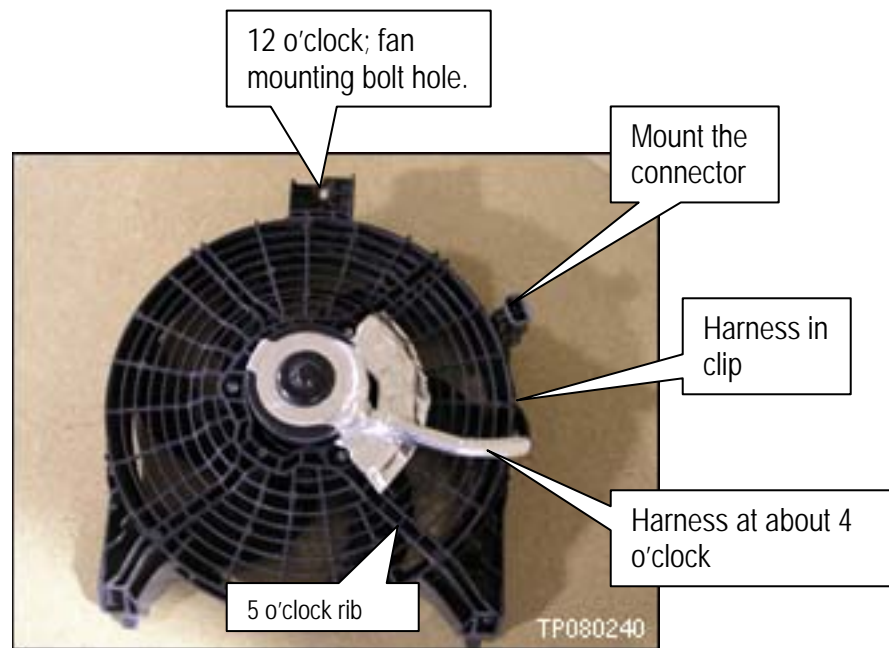

Figure D-16

14. Attach 3 tie-wraps as shown in Figure D-17.

- Use 7½ inch (19.5 cm) tie-wraps from the protector kit.
- Use the large 1 o'clock and 5 o'clock ribs for reference.
- **Pay close attention to the tie wrap locations.** Count the slots in the fan shroud to confirm correct tie-wrap locations.

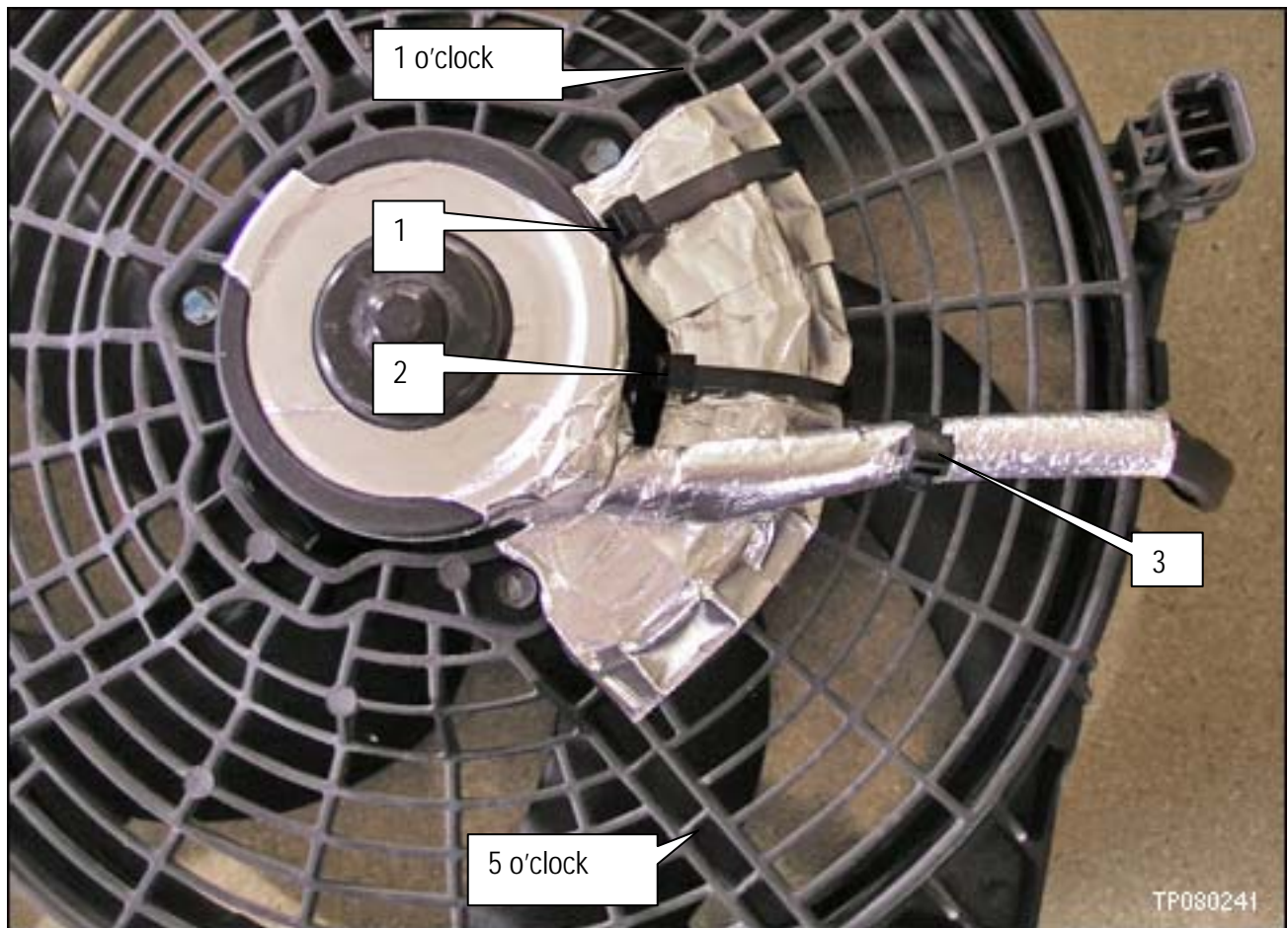

Figure D-17

15. Install the fan motor cover:

- Make sure the 4 clips are installed in the correct locations.
- Refer to Figures D-18 through D-21 for clip locations.
- Use the large 7 o'clock and 11 o'clock ribs for reference.
- Count the slots in the fan shroud to confirm locations for clips 3 and 4.

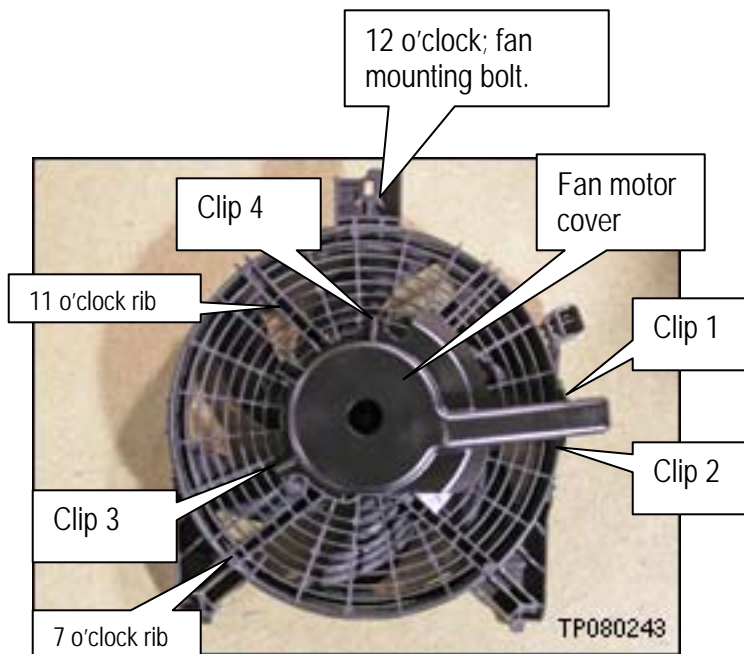

Figure D-18

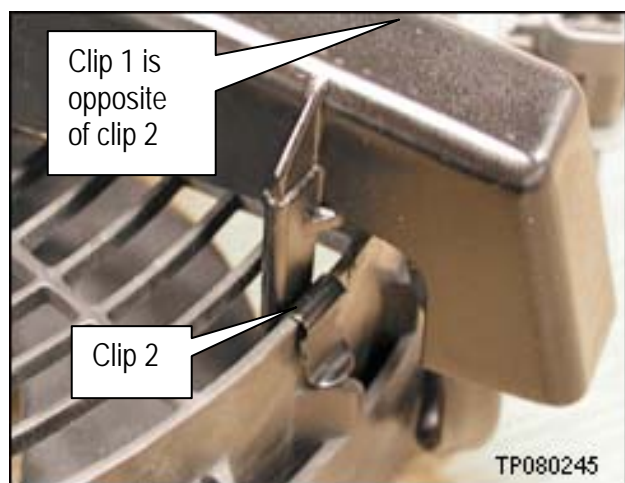

Figure D-19

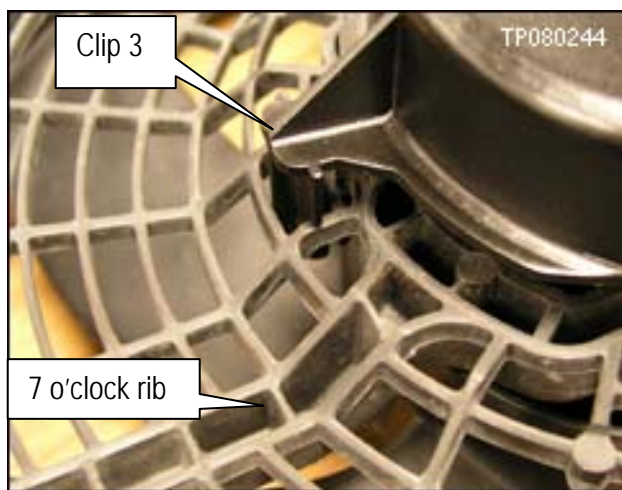

Figure D-20

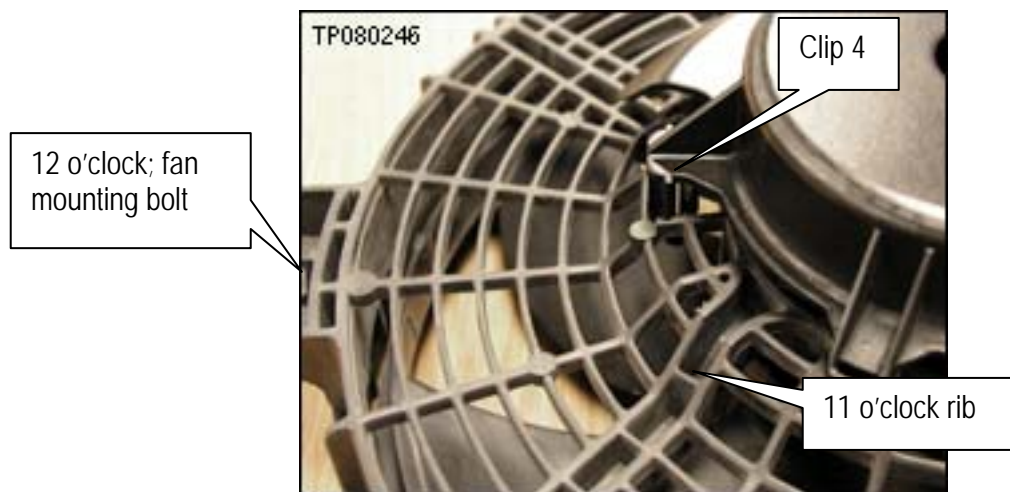

Figure D-21

16. Install 2 tie-wraps on the fan motor cover.
- Use 11 inch (28 cm) tie-wraps from the protector kit.
 - Refer to Figures D-22 through D-24 for tie-wrap locations.
 - Use the large 11 o'clock rib for reference.
 - Count the slots in the fan shroud to confirm locations as needed.

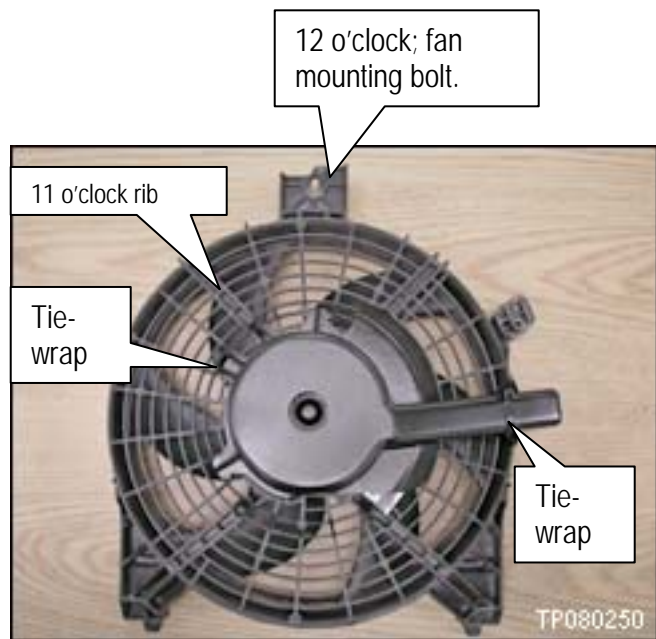

Figure D-22



Figure D-23

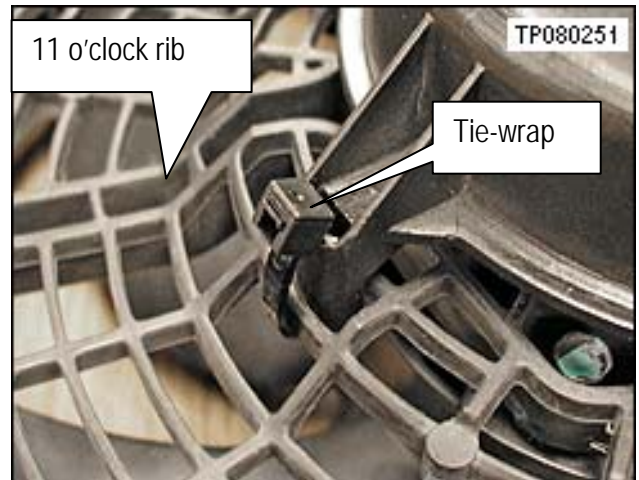

Figure D-24

17. Return to Procedure C (step 16 on page 22) for fan assembly installation.

PROCEDURE E: Install Maxi Fuse
(Install the Maxi Fuse only when a new fan is installed)



Figure E-1

NOTE: Maxi Fuse is installed only when replacing the fan motor assembly with a new one. The battery should already be disconnected and the radio station presets should have been recorded before removing the fan motor at the beginning of procedure C.

1. Remove the IPDM E/R upper cover.
 - IPDM E/R = Intelligent Power Distribution Module, Engine Room.

2. Remove the relay and fuse cover.

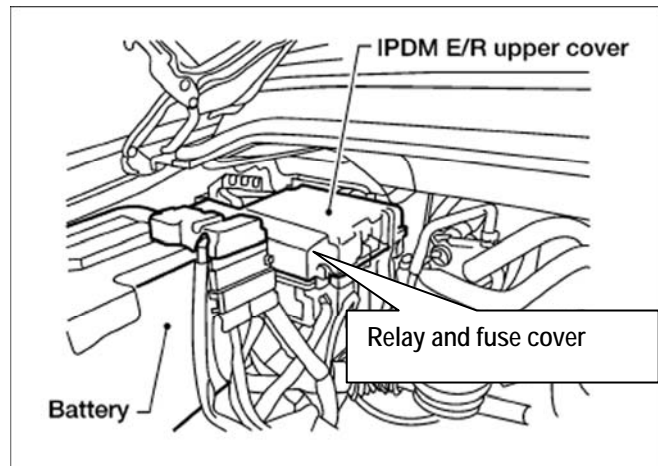

Figure E-2

3. Disconnect the white connector circled in Figure E-3.

- This is connector E120.
- This connector has 6 terminal slots with only 5 filled.

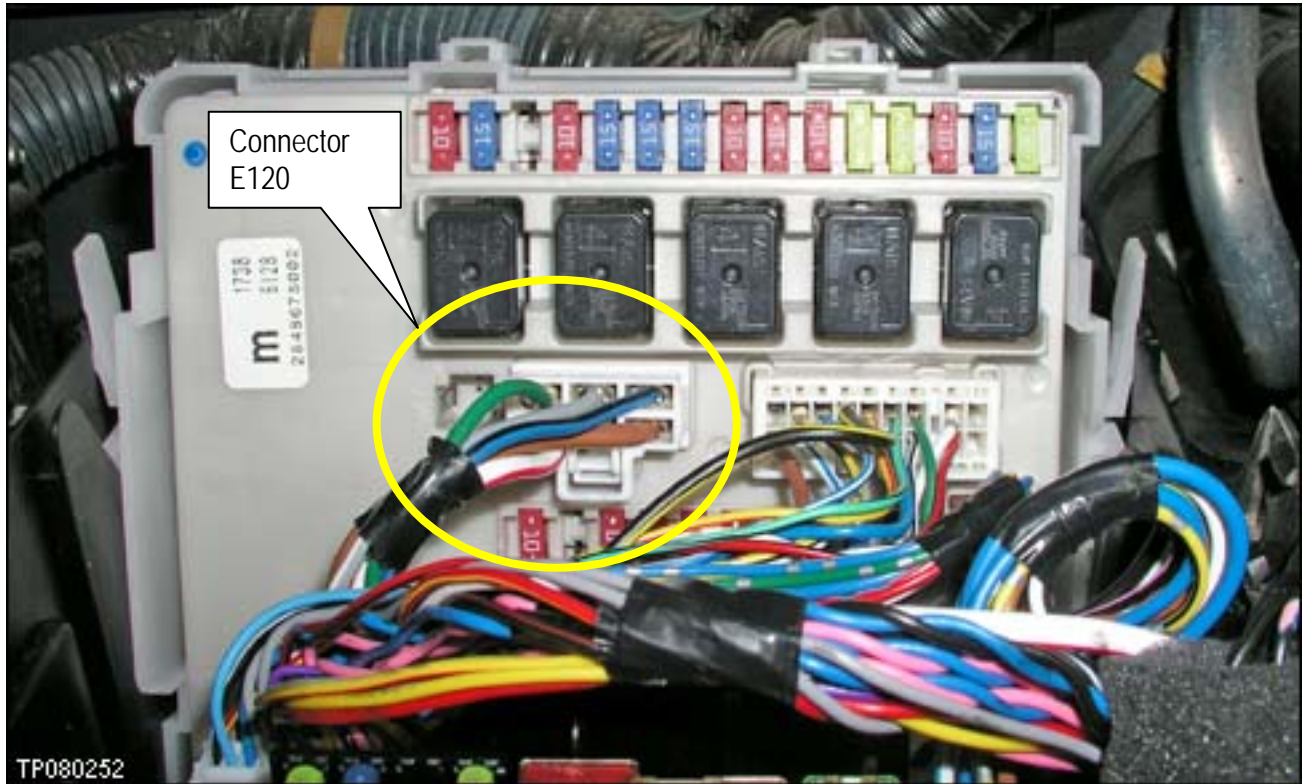

Figure E-3

4. Remove the green wire from connector E120.

- Use pin terminal tool J-38751-305 from Pin Tool Set J-38751-3, or equivalent.

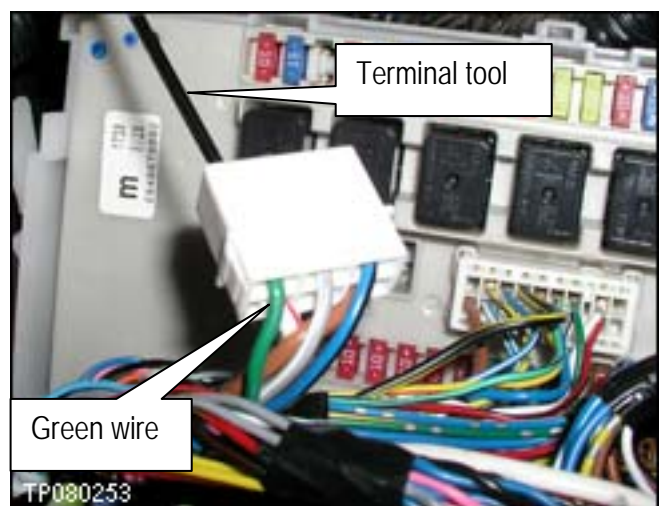
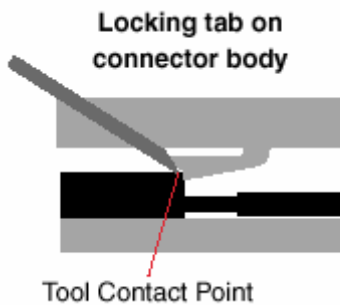

Figure E-4

5. Take the wire you removed from connector E120 and put it into the Maxi Fuse connector. Make sure to put it in the correct slot as shown in Figure E-5.
6. Insert the wire from the Maxi Fuse into the slot of connector E120 (see Figure E-5).

NOTE:

- The terminals will not snap in upside down.
- If the terminal won't snap-in, you are trying to put it in upside down; turn it over.

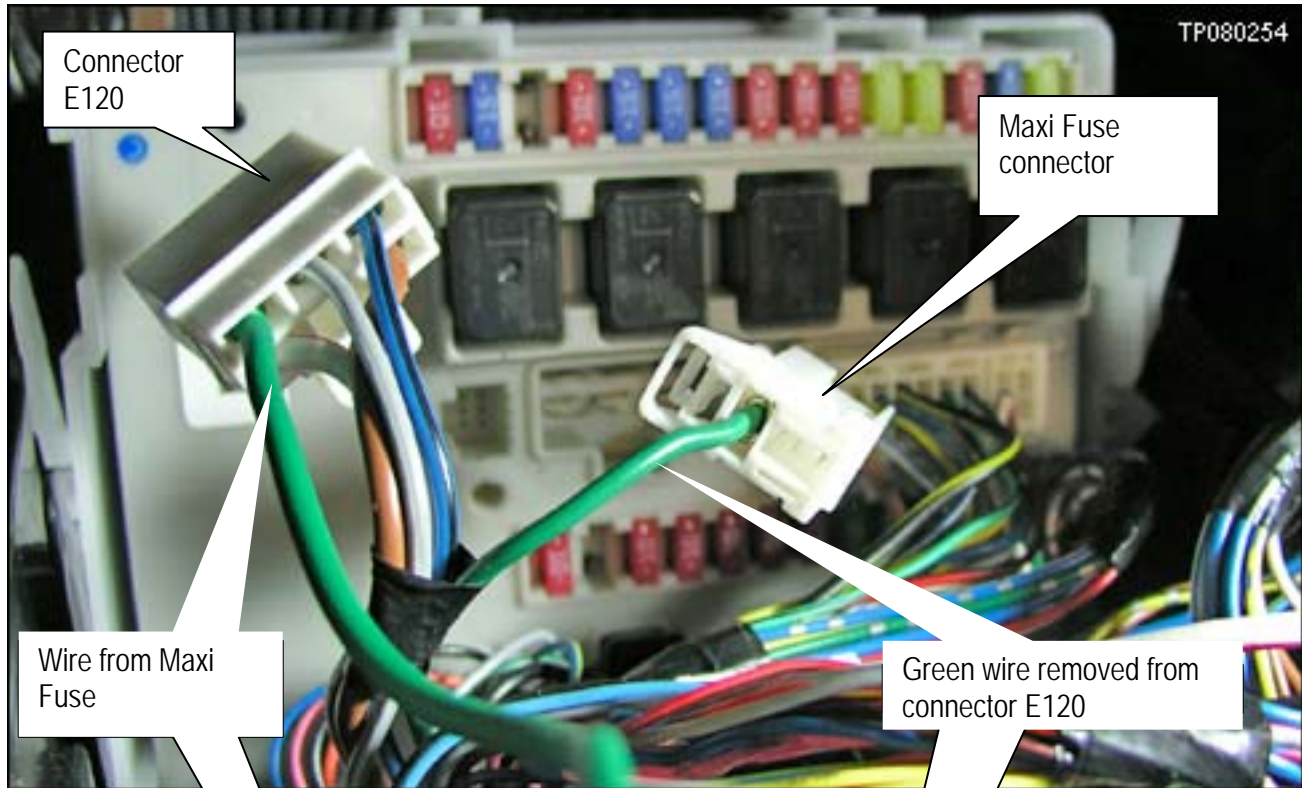
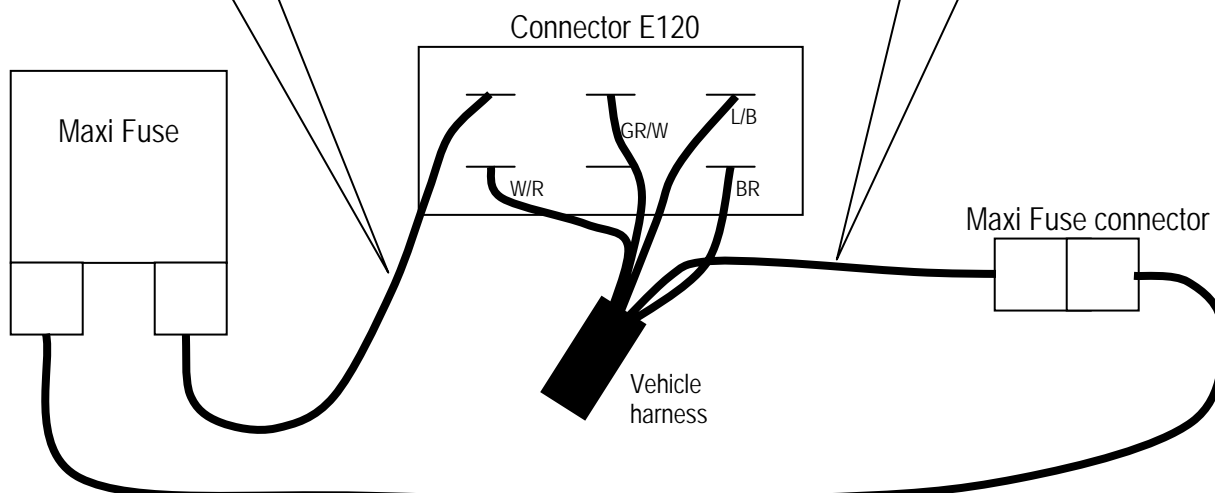

Figure E-5



7. Reconnect connector E120.
8. Connect the Maxi Fuse connector.
9. Position the Maxi Fuse, wires, and connector into the IPDM E/R box as shown in Figure E-6.

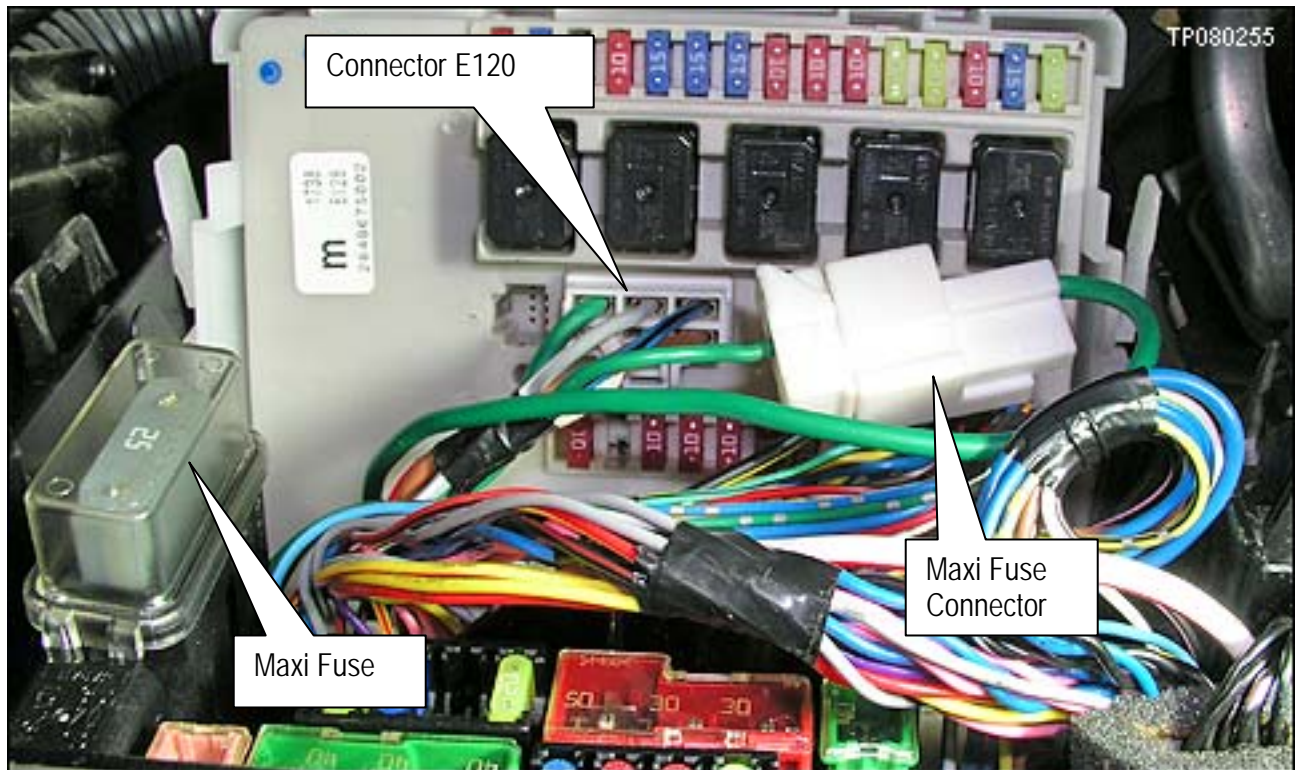

Figure E-6

10. Reinstall the IPDM E/R cover and the relay / fuse cover.
11. Connect the negative battery cable.
12. Reprogram the radio presets and set the clock.
13. Go to Procedure F on the next page.

PROCEDURE F: Confirm Fan Operation

1. Connect CONSULT-II to the vehicle.
2. Turn the ignition ON.
3. Select START (NISSAN BASED VHCL) > ENGINE > ACTIVE TEST > COOLING FAN
4. Use CONSULT-II to turn the condenser fan ON and then make sure the condenser fan is running.
5. Turn CONSULT-II OFF, turn the ignition OFF, and disconnect CONSULT-II from the vehicle.

PARTS INFORMATION

Description	Part #	Fan Motor Test	Quantity
Protective Covering Kit	27239-7S00A	OK	1
Fan & Motor Assy	92120-ZJ00A	NG	1
Harness Kit (contains Maxi Fuse with harness and sub harness for new fan motor)	24009 - 7S00A		1
Medium Strength Thread Locker	999MP-AM005P	N/A	Shop supply

Adhesive Covers in Protective Covering Kit

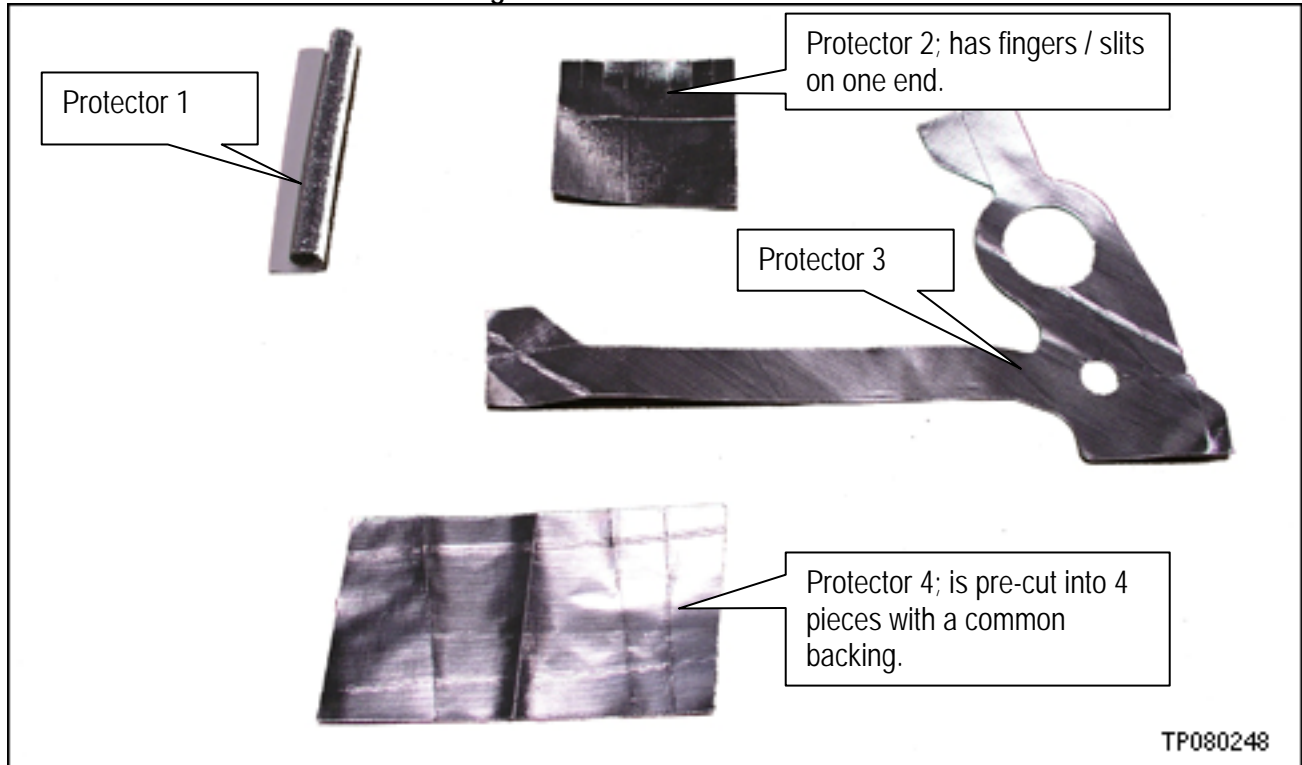

Other contents of Protective Covering Kit

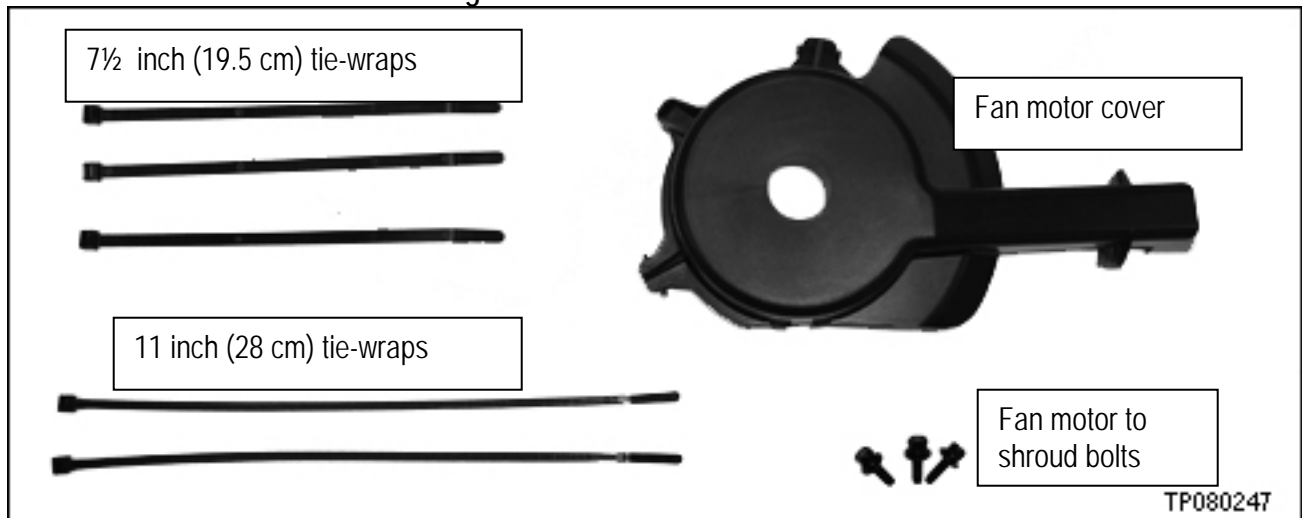

Parts Information cont.

Medium Strength Threadlock is available from the Nissan Direct Ship Chemical Care Product Program: Phone 1-800-811-0502, Fax 1-770-218-0148, Website order link via dealer portal www.NNAnet.com or direct www.NissanChemicals.com

CLAIMS INFORMATION

Submit a CM line claim using the following claims coding:

“CM” I.D.: PB080 – 2004 and 2005 vehicles built before March 17, 2005.

Refer to Infiniti Net to confirm the correct campaign ID #.

DESCRIPTION	OP CODE	FRT
Inspect Condenser Fan – OK (Procedure A only: 90 Watt Fan Type 1, or 140 Watt Fan Type 3 – No Action Required)	PB0800	0.2

OR

Without Grill Guard

DESCRIPTION	OP CODE	FRT
Test Condenser Fan – OK, Install Protector Kit, Confirm Operation (Procedure A, B C, D and F: Type 2 Fan motor is OK; R&R Fan Assembly; Install Protective Cover Kit; Confirm Fan Operation)	PB0801	1.2

With Grill Guard

DESCRIPTION	OP CODE	FRT
Test Condenser Fan – OK, Install Protector Kit, Confirm Operation (Procedure A, B C, D and F: Type 2 Fan motor is OK; R&R Fan Assembly; Install Protective Cover Kit; Confirm Fan Operation)	PB0803	1.4

OR

Without Grill Guard

DESCRIPTION	OP CODE	FRT
Test Condenser Fan – NG, RPL Fan, Install Maxi Fuse, Confirm Operation: (Procedure A, B C, E and F: Type 2 Fan motor is NG; R&R Fan Assembly; Install Maxi Fuse; Confirm Fan Operation)	PB0802	1.2

With Grill Guard

DESCRIPTION	OP CODE	FRT
Test Condenser Fan – NG, RPL Fan, Install Maxi Fuse, Confirm Operation: (Procedure A, B C, E and F: Type 2 Fan motor is NG; R&R Fan Assembly; Install Maxi Fuse; Confirm Fan Operation)	PB0804	1.4

CLAIMS INFORMATION continued on the next page

CLAIMS INFORMATION continued

“CM” I.D.: PB076 – 2005 and 2006 vehicles built on or after March 17, 2005.
 Refer to Infiniti Net to confirm the correct campaign ID #.

DESCRIPTION	OP CODE	FRT
Inspect Condenser Fan – OK (Procedure A only: 90 Watt Fan Type 1, or 140 Watt Fan Type 3 – No Action Required)	PB0760	0.2

OR

Without Grill Guard

DESCRIPTION	OP CODE	FRT
Test Condenser Fan – OK, Install Protector Kit, Confirm Operation (Procedure A, B C, D and F: Type 2 Fan motor is OK; R&R Fan Assembly; Install Protective Cover Kit; Confirm Fan Operation)	PB0761	1.2

With Grill Guard

DESCRIPTION	OP CODE	FRT
Test Condenser Fan – OK, Install Protector Kit, Confirm Operation (Procedure A, B C, D and F: Type 2 Fan motor is OK; R&R Fan Assembly; Install Protective Cover Kit; Confirm Fan Operation)	PB0763	1.4

OR

Without Grill Guard

DESCRIPTION	OP CODE	FRT
Test Condenser Fan – NG, RPL Fan, Install Maxi Fuse, Confirm Operation: (Procedure A, B C, E and F: Type 2 Fan motor is NG; R&R Fan Assembly; Install Maxi Fuse; Confirm Fan Operation)	PB0762	1.2

With Grill Guard

DESCRIPTION	OP CODE	FRT
Test Condenser Fan – NG, RPL Fan, Install Maxi Fuse, Confirm Operation: (Procedure A, B C, E and F: Type 2 Fan motor is NG; R&R Fan Assembly; Install Maxi Fuse; Confirm Fan Operation)	PB0764	1.4

OWNER'S LETTER (typical owner's letter)

Dear Infiniti Owner:

This notice is sent to you in accordance with the requirements of the National Traffic and Motor Vehicle Safety Act. Infiniti has decided that a defect that relates to motor vehicle safety exists in some 2005-2006 Model Year Infiniti QX56 manufactured between March 17, 2005 and August 21, 2006. (Also, certain 2004 Model Year Infiniti QX56 are included if the air conditioning condenser fan was replaced after the vehicle was originally purchased.) Our records indicate that you own or lease a Model Year 2005-2006 Infiniti vehicle identified by the VIN on the cover of this notice. (For Model Year 2004 vehicle owners, our records indicate that you own or lease a vehicle that may have been repaired using one of the affected replacement fans.)

Reason for Recall

The air conditioning condenser fan motor in your vehicle may have been manufactured out of specification, allowing for excessive water intrusion and inadequate drainage of moisture. If enough moisture accumulates in the motor, corrosion may occur, leading to increased temperature in the motor. Because of the motor's unique structure, this increased temperature could melt its wiring insulation and other plastic components and ultimately result in a fire.

What Infiniti Will Do

1. Your Infiniti dealer will inspect, and as needed, install a special protector kit on the existing air conditioning condenser fan to eliminate a potential for a fire to occur.
2. In addition, to ensure your continued satisfaction with the air conditioning system in your vehicle, Infiniti will test your air conditioning condenser fan motor to ensure that it is functioning as designed. If necessary, the motor will be replaced with a new one. (If a new motor is installed, the protector kit is not needed.)

This free service should take about 2 hours to complete, but your Infiniti dealer may require your vehicle for a longer period of time based upon the workshop schedule, or parts availability.

What You Should Do

Contact your Infiniti dealer at your earliest convenience in order to arrange an appointment to have your vehicle repaired. To ensure the least inconvenience for you, it is important that you have an appointment before bringing your vehicle to the dealer for repairs. Please bring this notice with you when you keep your service appointment. Instructions have been sent to your Infiniti dealer.

Warranty Extension

Infiniti has extended your vehicle's 2004-2006 Infiniti New Vehicle Limited Warranty as it applies to the Air Conditioning Condenser Fan Motor to 84 months or 100,000 miles, whichever comes first from your vehicle's in-service date. Please remove the sticker located on the bottom of this letter and place it on the cover of your Infiniti Warranty Information Booklet to remind you of the warranty extension, should you ever need to use it.

If you have previously paid to have your condenser fan motor replaced prior to this campaign, you may be eligible for reimbursement of the related expense. Please contact the National Consumer Affairs Department for instructions. National Consumer Affairs Department, Infiniti Division, Nissan North America, Inc., P.O. Box 685003, Franklin, TN 37068-5003. The toll free number is 1-800-662-6200.

You may also submit a complaint to the Administrator, National Highway Traffic Safety Administration, 1200 New Jersey Avenue, SE., Washington, DC 20590; or call the toll-free Vehicle Safety Hotline at 1-888-327-4236 (TTY: 1-800-424-9153); or go to <http://www.safercar.gov>.

Federal law requires that any vehicle lessor receiving this recall notice must forward a copy of this notice to the lessee within ten days.

Thank you for your cooperation. We are indeed sorry for any inconvenience this may cause you.

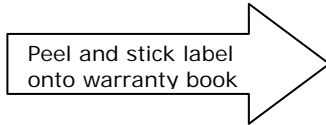

Infiniti has extended your vehicle's 2004-2006 Infiniti New Vehicle Limited Warranty as it applies to the Air Conditioning Condenser Fan Motor to 84 months or 100,000 miles, whichever comes first from your vehicle's in-service date. All other warranty terms, limitations, and conditions remain unchanged.

