



---

MACK TRUCKS, INC.  
2100 MACK BOULEVARD  
P.O. BOX M  
ALLENTOWN, PA 18105-5000

December 31, 2007

TO: DISTRIBUTOR PRINCIPALS  
SERVICE MANAGERS

SUBJECT: Vehicle Safety Recall - SC0324 – Third Release  
ASET™ AC Fuel Injection Lines

On Mack CH, CHN, CX, and CXN model vehicles manufactured from January 2002 through January 2007 with ASET™ AC model engines. The engine as configured with an external EGR system makes servicing the fuel injection lines difficult when using traditional tools; therefore, it is possible for fuel leaks to develop when removing and installing the fuel injection lines. A leak in the fuel injection line may spray fuel on the hot surfaces of the EGR system, which could result in an engine fire.

To resolve this issue, Mack has developed special tools to ensure the correct torque is applied when replacing a fuel injection line, developed a DVD to use as a visual aid when training technicians, and has developed an improved fuel injection line that offers a better clamping surface when torqued.

Approximately 4,539 vehicles (4,223 US and 316 Canada) are involved in the second release of this safety recall. Subsequent releases will occur about every six weeks, and will be communicated with a Safety Recall Alert and through dealer and owner notifications.

A copy of the service bulletin covering the repair instructions and procedures is enclosed.

It is important that preparation be made immediately to assure prompt inspection and/or correction of all vehicles involved. The National Traffic and Motor Vehicle Safety Act and Canadian Motor Vehicle Safety Act requires dealers to insure that all new and used vehicles are free of safety defects and comply with all relevant safety standards at the time of delivery to the consumer. All Safety Recalls, which affect new or used inventory, must be performed before the vehicle is sold or leased. Please refer to Service Operations Service Letter #SL-004-001 dated 11/19/92 regarding the aforementioned amendment.

Please note that Dealers are responsible for performing the recall on all vehicles subject to the recall at no charge to the owner regardless of mileage, age of vehicle, or ownership from this time forward. Additionally, the National Traffic and Motor Vehicle Safety Act requires that the owner's vehicle(s) be corrected within a reasonable time after parts are available to the Dealer. The law states that failure to repair a vehicle within (60) days after tender for repair shall be a prima facia evidence of unreasonable time. However, circumstances of a particular situation may reduce the sixty (60) day period. If the vehicle is not repaired within a reasonable time, the vehicle owner may be entitled, without charge, to a reasonable equivalent vehicle or refund of the purchase price, less reasonable allowances for depreciation.

Please use the enclosed Notice of Mandatory Safety Campaign card(s) to report sold or transferred trucks. Make sure these cards are returned to us and not directly to the customer or to another dealer. A notice of the recall will be mailed to all identified registrants of affected vehicles. To avoid warranty denial of your claim for reimbursement of expenses connected with this recall, first, make sure the truck presented for the recall has the recall authorization loaded in eWarranty. Reserve the recall authorization in eWarranty prior to performing the recall.

Mack Trucks, Inc., recommends a follow-up by telephone or a personal visit, of all owners of vehicles subject to the recall who fail to bring the vehicle(s) in for repair. Your District Service Manager will be contacting you to assure that this recall attains the visibility we feel is necessary to ensure 100% completion. Please be prepared to review your progress and/or any problems associated with the recall.

If you have any questions about this recall, which may not have been covered in this letter or enclosures, please contact the Regulatory Affairs group by email at [vtna.regulatoryaffairs@volvo.com](mailto:vtna.regulatoryaffairs@volvo.com)

Very truly yours,

MACK TRUCKS, INC.

Enclosures: Customer Notice  
Service Bulletin  
Notification Cards



# SAFETY RECALL

(Previously called Vehicle Recall)

## SC324

(Not applicable to Mack Trucks Australia)

**Date:** 11/16/07 (Supersedes SC324 dated 10/05/07)

**To:** All MACK Dealers

**Subject:** High-Pressure Injection Line Replacement — ASET™ AC Engines

On ASET™ AC engines, the components that make up the exhaust gas recirculation (EGR) system make servicing the high-pressure fuel injection lines difficult when using traditional hand tools. As a result, it is possible for fuel leaks to develop when injection lines are replaced, and a leaking injection line could spray fuel on the hot surfaces of the EGR system, resulting in an engine fire. To resolve this issue, Mack Trucks, Inc. has developed a set of special tools to ensure that correct torque is applied to the fuel line connections when lines are replaced. Included with the set of special tools is a training DVD for use as a visual aid to train technicians on the proper procedures for replacing the high-pressure fuel injection lines.

In addition to the special tools and technician training programs, a revised fuel line has been developed. This revised fuel line provides improved clamping surfaces for a leak-free connection when properly tightened. The six high-pressure fuel lines on ASET™ AC-equipped chassis must be replaced with these new lines. Approximately 39,310 chassis are involved in this campaign. A list of affected chassis has been sent to all applicable dealers.

Before proceeding, verify Safety Recall eligibility by:

- a. Checking Safety Recall status in eWarranty.
- b. Checking the campaign completion label located on the passenger-side door. If the campaign has been completed, SC324 should be written on the label.

### NOTE

Technicians who perform service procedures on fuel injection lines must be certified. Certification is available through the North American Institute. For MACK dealer technicians, certification can be earned by completing the *ASET™ Fuel Injection Line* e-learning course in LearnGate.

For technicians outside the MACK dealer network, a certification kit is available for purchase through the North American Institute. To purchase the kit, visit the North American Institute website at [www.n-a-institute.com](http://www.n-a-institute.com). Click on "Purchase Training Materials," and then select the "Engine" category. Scroll down the list of engine training materials to locate the TR5-014 *MACK ASET™ Fuel Injection Line Certification Kit*. A valid credit card is required to purchase the kit. An instructional DVD will be shipped along with instructions on taking the certification test. The test is sent through e-mail and requires that the personal computer being used to take the test have Adobe® Reader® (at minimum) installed. Adobe® Reader® can be downloaded for free by visiting the Adobe website at [www.adobe.com](http://www.adobe.com).

Procedures for installing the high-pressure injection lines are as follows:

**NOTE**

Some engines may still have the fuel line sleeves installed (either factory installed or installed as instructed in Safety Recall SC317). If the fuel line sleeves are present, they must be discarded. DO NOT install fuel line sleeves with these new injection lines.

It is extremely important that proper procedures be used when replacing the high-pressure injection lines, and that proper tools be used to tighten the injection line end nuts to avoid damage to the lines. To properly tighten the fuel line end nuts, the injection line tool kit (kit No. 57GC2254) must be used. This kit contains a set of torque adapters which must be used to properly tighten the line nuts at both the cylinder head and unit pump ends of the injection lines.

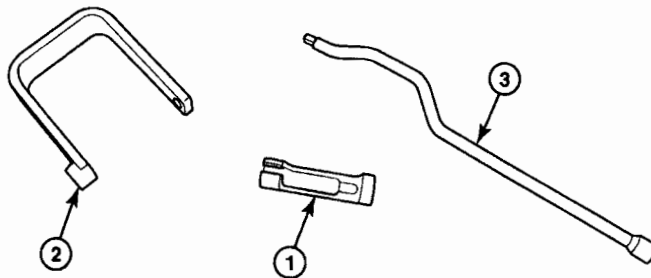

006917a

**Figure 1 — Injection Line End Nut Torque Adapter Tool Kit (Kit No. 57GC2254)**

- |   |  |
|---|--|
| <p>1. Fuel Line Socket (part No. 525GC22), used to tighten the cylinder head end line nut for injection line Nos. 1, 2, 4, 5 and 6.</p> <p>2. Direct-Torque Special Wrench (part No. 525GC31), used to tighten the cylinder head end line nut for injection line No. 3 (ASET™ AC engines only).</p> | <p>3. Direct-Torque Extension (part No. 2QM3114), use with a suitable flare nut crowfoot adapter such as Snap-On tool Nos. FRHM17 for 17 mm line nuts or FRHM19 for 19 mm line nuts when tightening the unit pump ends of the injection lines.</p> |
|---|--|

**NOTE**

The tools listed above are only to be used for tightening the injection lines. Use suitable open-end wrenches to loosen the line nuts when removing the lines.

## Preparation for Injection Line Removal and Installation

### NOTE

The replacement high-pressure injection lines for this campaign are available as a kit (kit No. 57GC2255). This kit contains six injection lines (part No. 203GC4383M) and a warning label (part No. 4MR21141M). For parts ordering information, refer to the information provided under the heading "Parts Required."

1. Secure the chassis for service, apply the parking brakes and block the wheels to prevent the vehicle from moving.
2. Open the hood.
3. Disconnect the batteries by disconnecting the negative battery cable(s) first, and then the positive cable(s). If equipped with dual battery boxes, the batteries on both sides of the vehicle must be disconnected.
4. Remove the inlet air duct. After the duct has been removed, use clean shop rags to cover the turbocharger inlet and the air compressor inlet pipe.
5. Remove the air cleaner assembly.
6. Remove the two clamps that secure the mass flow tube to the engine, and then remove the hose clamps from the coupling hoses at both ends of the tube. Remove the mass flow tube and set the tube to the side, in a location where it will not interfere with the remaining procedures. This can be done without disconnecting the mass flow sensor harnesses.

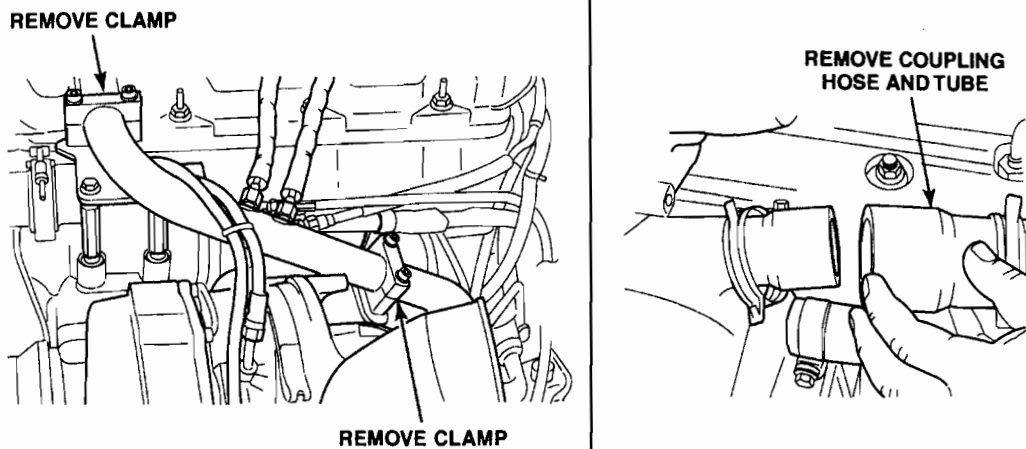

272110a

Figure 2 — Removing Mass Flow Tube

7. Disconnect both ends of the EGR valve oil line, and then remove the line from the engine.

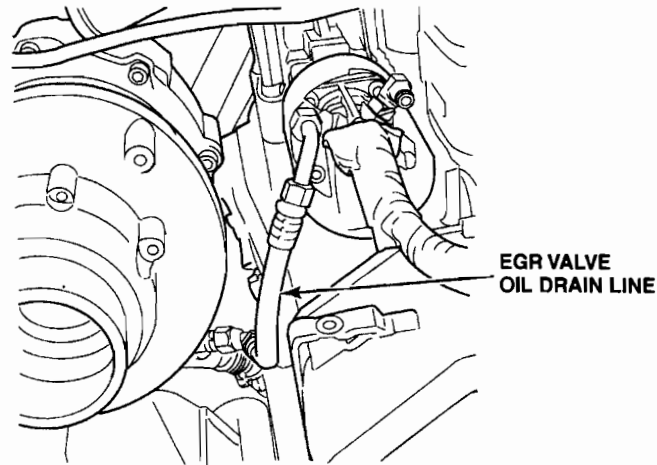

272109a

**Figure 3 — Removing EGR Oil Drain Line**

8. Remove the nuts that secure the unit pump two-piece outer heat shields, and then remove the outer heat shields from the engine. Remove the rear heat shield first, as the two shields overlap each other.
9. Loosen the two bolts at each end of the intermediate heat shield. Slide the shield outward to disengage the bolts, and then place the shield on top of the inner heat shield against the cylinder block.

#### **Removal and Installation of Injection Line**

##### **NOTE**

Before removing any of the high-pressure fuel injection lines, use a suitable spray solvent such as Brakleen® to thoroughly clean the area at the cylinder head end, and then dry the area with shop air to prevent the entry of dirt and other contaminants at reassembly.

Remove and replace the fuel injection lines one line at a time.

DO NOT reuse injection lines. The line ends take a set with the adjoining mating surfaces. Existing lines must be replaced with new lines.

1. Using suitable hand tools, completely loosen the end nuts at both the unit pump and cylinder head ends of the injection lines.

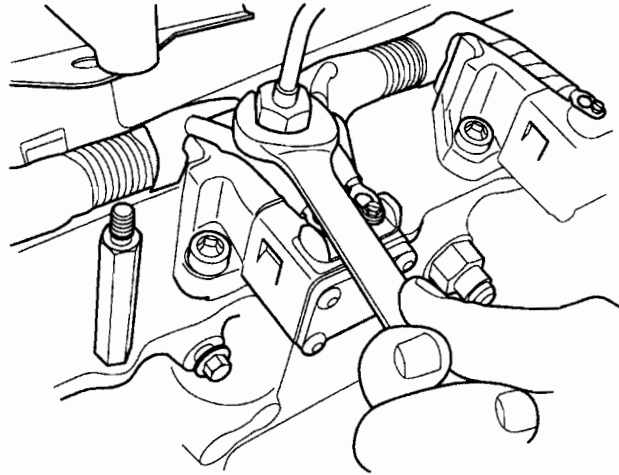

272102a

**Figure 4 — Using Standard Hand Tools to Loosen Injection Line Nuts (Unit Pump End Shown)**

2. Disengage the end of the line from the unit pump, and then remove the injection line from the engine.
3. Remove the protective caps from the ends of the new injection line (part No. 203GC4383M, supplied in kit No. 57GC2255).
4. Apply one to two drops of clean engine oil to the line ends and the nut threads.

**⚠ WARNING**

**DO NOT BEND A FUEL LINE.** Fuel injection lines are subjected to high hydraulic pressures in operation. Even slight bends can weaken the line and result in an increased risk of fuel line split or breakage.

**When installing the new injection line, avoid contacting the ends of the lines with other surfaces, as this may damage the sealing surfaces or pick up debris.**

5. Install the injection line by inserting the cylinder head end of the line into the port in the cylinder head, and then engaging the opposite end of the line with the unit pump seat. Hand-tighten the end nuts at both the cylinder head and unit pump ends.

When installing the No. 3 injection line, caution must be used to avoid bending the line. The No. 3 injection line should be installed as follows:

- a. Slide the end nut and sleeve against the bend in the line.

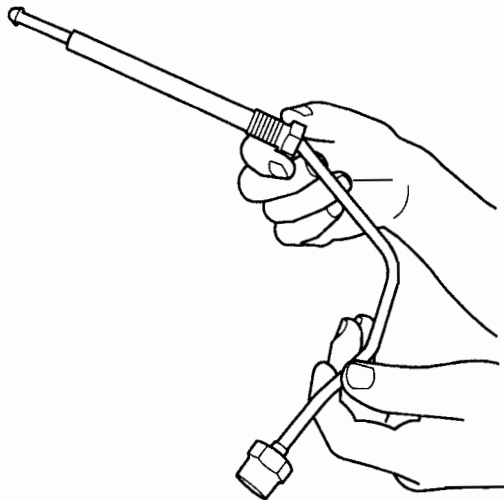

272108a

**Figure 5 — Slide Nut and Sleeve Against Bend in Line**

- b. Holding the line with the ends facing the rear of the engine and the upper nut and sleeve against the bend in the line, guide the line between the turbocharger housings and down behind the EGR cooler.

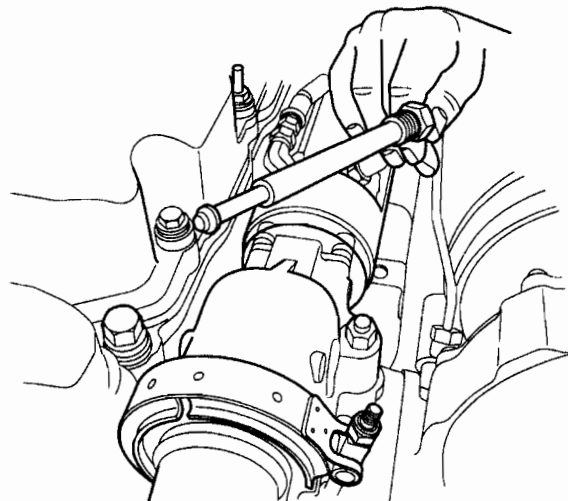

272107a

**Figure 6 — Guiding Line Between Turbocharger Housings**

- c. When the line is down far enough so that the upper end is below the EGR valve, rotate the line slightly and begin moving the line upward while guiding the end of the line toward the cylinder head port. Keep the unit pump end of the line facing the rear of the engine.

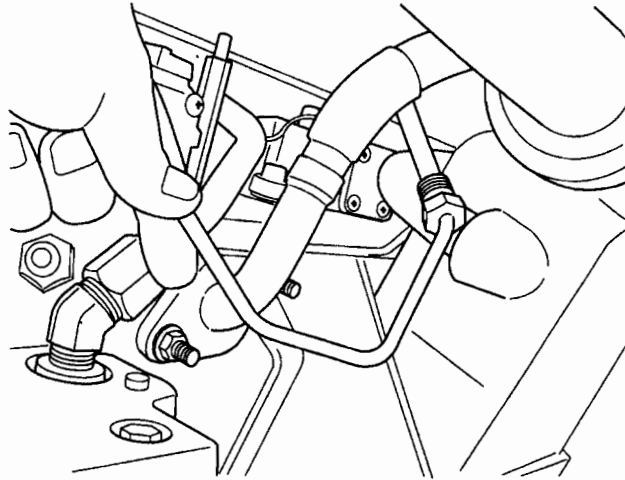

269956a

Figure 7 — Guiding End of Line Toward Cylinder Head Port

- d. Insert the line into the cylinder head port. Push the line fully into the port while rotating the unit pump end of the line until the end nut aligns with the unit pump seat. Hand-tighten both end nuts.

### Tightening the Fuel Line End Nuts



Torque specifications for the injection line end nuts are as follows:

- **Unit Pump End Nut** — 33 N•m (25 lb-ft)
- **Cylinder Head End Nut** — 40 N•m (30 lb-ft)

To properly tighten the fuel line end nuts, the special torque adapter kit (tool No. 57GC2254) is required. This kit contains the following torque adapters which must be used to tighten the specific end nuts as specified:

- **525GC22, Fuel Line Socket** — Use this tool to tighten the cylinder head end line nuts for line Nos. 1, 2, 4, 5 and 6.
- **525GC31, Direct-Torque Adapter** — Use this tool to tighten the cylinder head end line nut for line No. 3 (ASET™ AC engines only).
- **2QM3114, Direct-Torque Extension** — Use this tool along with a suitable flare nut crowfoot adapter (such as Snap-On tool Nos. FRHM17 for 17 mm end nuts or FRHM19 for 19 mm end nuts) to tighten all the unit pump end line nuts.

### NOTE

*To ensure a proper connection, the end nuts (both the cylinder head and unit pump ends) must be tightened to specifications, immediately backed off one nut flat and retightened to specifications. This critical “joint conditioning” procedure is necessary to ensure a proper leak-free connection.*

Tighten the fuel line end nuts as follows:

- REV
1. Tighten the line nut at the cylinder head end first. For line Nos. 1, 2, 4, 5 and 6, use the special injection line socket (tool No. 525GC22) and an accurately calibrated 3/8" drive click-type torque wrench. Tighten the nut to 40 N•m (30 lb-ft), immediately back off the nut slightly (approximately one nut flat) and then retighten the nut to 40 N•m (30 lb-ft). This critical "joint conditioning" procedure is necessary to ensure a proper leak-free connection.

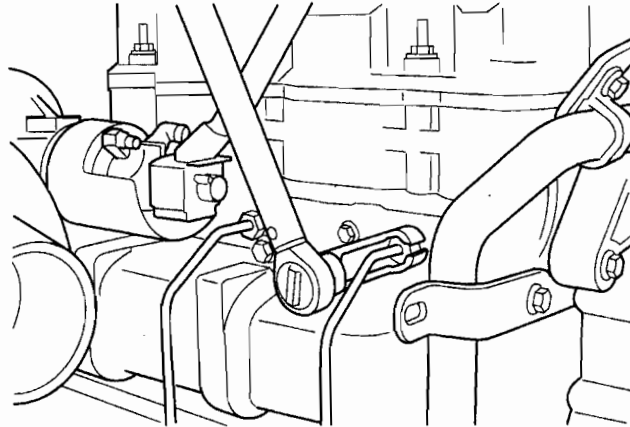

272106a

**Figure 8 — Using the Injection Line Socket (Tool No. 525GC22)**

- REV
- To tighten the cylinder head end line nut for line No. 3, use the special direct-torque adapter tool (tool No. 525GC31) and an accurately calibrated 3/8" drive click-type torque wrench. Place the tool over the EGR valve and install the socket on the line nut. Install the torque wrench and then tighten the nut to 40 N•m (30 lb-ft), immediately back off the nut slightly (approximately one nut flat) and retighten to 40 N•m (30 lb-ft).

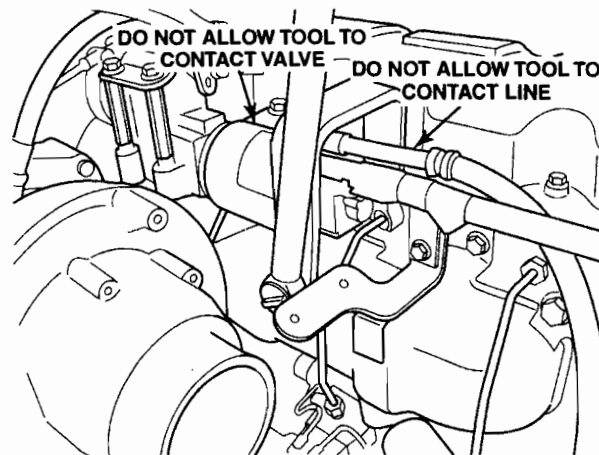

272105a

**Figure 9 — Using the Direct-Torque Adapter (Tool No. 525GC31)**

**NOTE**

Use care when tightening the end nut with the direct-torque adapter so that the tool does not contact the EGR valve or any of the oil lines surrounding the valve. Doing so will result in a false torque reading and an under-torque condition.

2. Bleed the injection line(s) as follows:

**NOTE**

If all six injection lines have been replaced, snug the line nut(s) at the unit pump end(s) with an open-end wrench, and then begin the bleed procedure at cylinder No. 6. Continue with cylinder Nos. 5, 4, 3, 2 and then 1.

- a. Using a standard open-end wrench, snug the unit pump line nut, and then back the line nut off one turn.

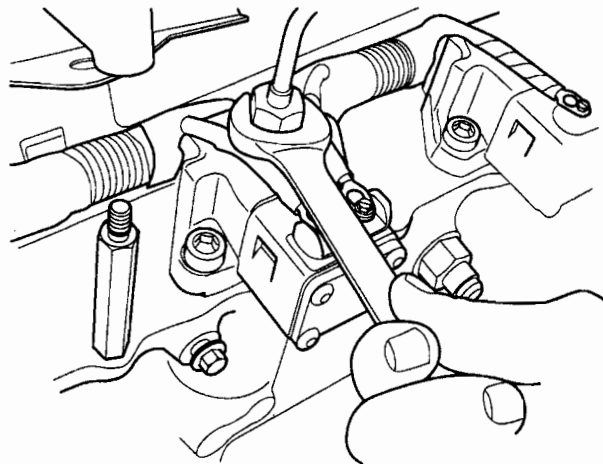

272102a

**Figure 10 — Loosening Unit Pump Line Nut with a Standard Open-End Wrench**

- b. Gently lift the injection line to unseat it from the unit pump.

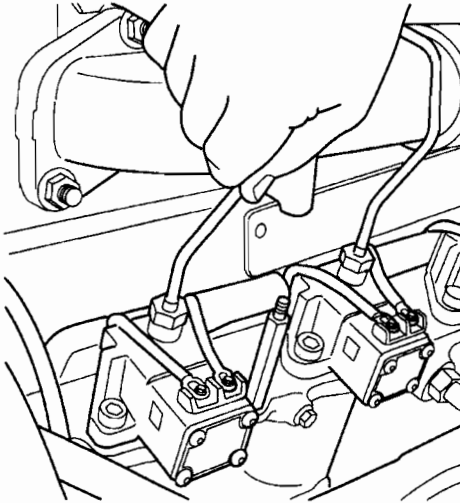

272104a

**Figure 11 — Unseating Injection Line at Unit Pump**

- c. Purge the air from the line by pumping the hand primer until a steady stream of fuel is seen coming from the unit pump connection with each stroke of the hand primer.
  - d. When a steady stream of fuel is seen at the unit pump connection, use a standard open-end wrench to snug the unit pump line nut.
  - e. Repeat the above steps for the remaining injection lines that have been replaced.
3. Once the air has been purged from the line and the line nut snugged with the open-end wrench, use the special direct-torque extension (tool No. 2QM3114), the appropriate flare nut crowfoot adapter (such as Snap-On tool Nos. FRHM17 for 17 mm end nuts or FRHM19 for 19 mm end nuts) and an accurately calibrated 3/8" drive click-type torque wrench to tighten the unit pump line nuts. Tighten the line nut to 33 N•m (25 lb-ft), immediately back off the nut slightly (approximately one nut flat) and then retighten to 33 N•m (25 lb-ft).

REV

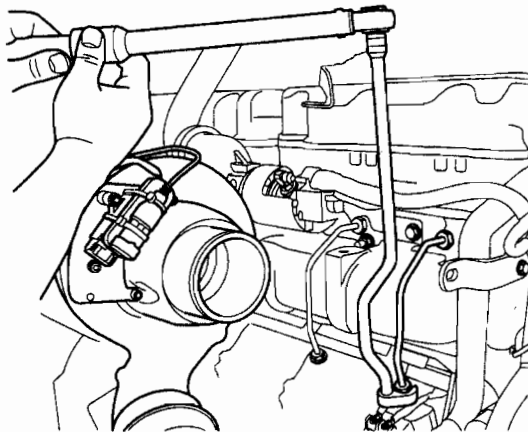

272100a

**Figure 12 — Using Direct-Torque Extension (Tool No. 2QM3114) and Flare Nut Crowfoot Adapter**

4. After the line nuts at both the cylinder head and unit pump ends have been tightened and conditioned, use a suitable spray solvent such as Brakleen® or equivalent and shop air to clean any residual fuel that may be present on the engine or the unit pumps.

### Reassembly

Reinstall all the components that had been removed previously. When reinstalling the unit pump heat shields, ensure that the intermediate shield is installed fully inboard and centered so that it does not contact the unit pump line nuts. When reinstalling the inlet air duct, remove the cover from the turbocharger inlet and check and remove debris that may have found its way inside the compressor housing. Ensure that the duct clamps are properly oriented so as to not cause any damage to the hood when it is closed. Torque specifications for the various fasteners are as follows:

- Unit pump heat shield — 20 N•m (15 lb-ft)
- Intermediate heat shield — 8 N•m (72 lb-in)
- Mass flow tube clamps — 10.8 N•m (96 lb-in)
- Inlet air duct clamps — 9 N•m (80 lb-in)
- EGR valve oil line end fittings — 27 N•m (20 lb-ft)

Reconnect the batteries by connecting the positive battery cable(s) first, and then the negative cable(s).

Start the engine and allow it to idle for approximately 5 minutes. Stop the engine and check for fuel leakage at both ends of the injection lines. Also check for oil leakage at both ends of the EGR valve oil line. If no leakage is seen, close the hood and perform a short road test. Return to the service facility and recheck for fuel or oil leakage to ensure that the fuel injection lines and the EGR valve oil line have been properly installed.

<b>NOTE</b>
-------------

When starting the engine, it is important to crank continuously for up to 30 seconds. Continuous cranking is required because the fuel delivery rate increases with increased cranking time. This will help to purge any remaining air in the fuel injection lines.

---

There should be a fuel injection warning label (part No. 4MR21141M) affixed to the inlet air duct, just above the turbocharger inlet. If a label is not present, the label supplied in the kit must be applied. Be sure to clean the area of the duct where the label is to be applied with a suitable cleaning fluid (such as alcohol or some other type of solvent) that will dry or evaporate quickly, and not leave a residue or damage the air duct. The label adhesive allows it to be quickly lifted off the duct immediately after application, and then reapplied, should alignment of the label not be correct at the first application.

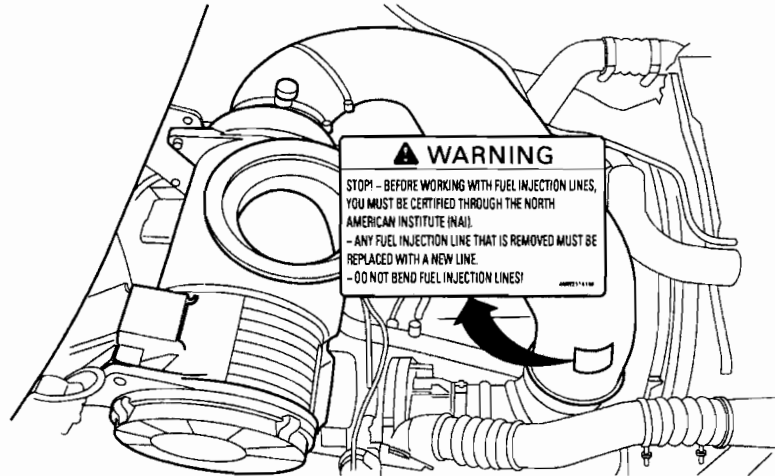

272101a

**Figure 13 — Fuel Line Warning Label (Part No. 4MR21141M)**

### NOTE

To signify that the campaign has been completed, use a permanent-type marker (such as a Sharpie®) to write the campaign number (SC324) and completion date in the spaces provided on the Campaign Completion label located on the lower edge (below the door latch) of the passenger-side door. If a label is not already affixed to the door, apply a label (part No. TS897) and supply the information as required. Campaign Completion labels are available in packs of 50 and can be ordered by faxing a completed BR313 to Pacesetters Business Services at 610-264-9465.

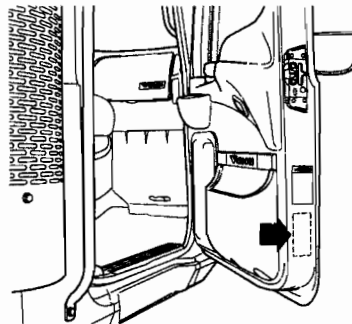

703153a

**Figure 14 — Campaign Label Location**  
SC324 — Page 12 of 13

**Parts Required:**

Qty	Part No.	Description
1	57GC2255	Kit, high-pressure injection line replacement (includes six injection lines [part No. 203GC4383M] and one warning label [part No. 4MR21141M])

Replacement kits CAN ONLY be ordered by calling 1-877-800-4945. When placing an order, the chassis model and serial number of the truck being serviced must be supplied.

Because there are a limited number of injection line kits available at this time, groups of vehicles will be recalled on different dates. The first release will occur on September 4, 2007, and will include 4,498 chassis. Subsequent releases will occur approximately every 6 weeks thereafter, and the releases will be communicated to the dealer network by a Safety Recall Alert.

If an ASET™ AC-equipped chassis which has not yet been recalled but is at the dealership or service facility for any type of service that requires removal of a fuel injection line, it is strongly recommended that this recall be performed and the repair reported back to Mack Trucks, Inc. by calling the dedicated phone number (1-877-800-4945). Calling this dedicated phone number will automatically place an order for the replacement fuel line kit, and also place the chassis on the SC324 recall list which enables the warranty claim to be submitted. Any replacement fuel line installed on an ASET™ AC-equipped vehicle will require a RECALL warranty claim to be submitted. Please allow 1–2 business days from the date the part was ordered to build the RECALL claim. If the RECALL claim is still unavailable in eWarranty, check to be sure the proper parts ordering procedures were followed.

**Removed Parts:**

The removed injection lines must be destroyed by bending and then scrapped.

**Reimbursement:**

Campaign expenses are to be recovered through normal warranty claim procedures. Enter the following information on the warranty claim:

<b>UNDER</b>	<b>ENTER</b>	
Failed Part (Causal Part) .....	SC0324	
eWarranty Authorization No.....	SC0324	
Labor Code/Allowance .....	222 1B 23 95 — 0.2 hr.	Time to take charge of vehicle and determine campaign status by checking eWarranty and the campaign completion label. NOTE: Only one "take-charge" time per vehicle service visit is allowed.
	222 1C 23 95 — 2.2 hrs.	Time allowed to replace six high-pressure injection lines on ASET™ AC engines involved in this campaign, clean spilled fuel with solvent as outlined in procedures and perform short road test. Does not include "take-charge" time.

<b>NOTE</b>
-------------

As required by Federal Motor Vehicle Safety Standards 49 CFR 573.11, no vehicle subject to an open safety campaign shall be delivered to the customer until such time as the defect or noncompliance is remedied.



MACK TRUCKS, INC.  
2100 MACK BOULEVARD  
P.O. BOX M  
ALLENTOWN, PA 18105-5000

**SAFETY RECALL SC0324  
JANUARY 2008**

**DEAR MACK TRUCK OWNER:**

This notice is sent to you in accordance with the requirements of the National Traffic and Motor Vehicle Safety Act.

Mack Trucks, Inc. has decided that a defect, which relates to motor vehicle safety, exists in certain Mack CH, CHN, CX, and CXN model vehicles manufactured from January 2002 through January 2007 with ASET™ AC model engines.

**IMPORTANT NOTE: THIS RECALL SUPERSEDES SAFETY RECALL SC0317**

**SAFETY DEFECT:** The engine as configured with an external Exhaust Gas Recirculation system makes servicing the fuel injection lines difficult when using traditional tools; therefore, it is possible for fuel leaks to develop when removing and installing the fuel injection lines.

**SAFETY RISK:** A leak in the fuel injection line may spray fuel on the hot surfaces of the Exhaust Gas Recirculation system, which could result in an engine fire.

**PRECAUTIONS YOU CAN TAKE:** The inspection procedure, which is attached, was mailed to all owners back in February 2007. This instruction MUST continue to be used until your vehicle is repaired and MUST be included in your pre-trip inspection. If leaks are seen, DO NOT proceed, and DO NOT operate the vehicle. Call your local MACK dealer or if after hours contact the MACK OneCall™ CompleteCare center for further instructions. Also, we strongly recommend, that you make an appointment to have your vehicle repaired as soon as possible.

**TIME REQUIRED FOR THE REPAIR:** The labor time required to inspect your vehicle is approximately two hours.

**WHAT YOU SHOULD DO:** You should contact the nearest Mack Parts and Service Center and make an appointment. The fuel injection lines will be replaced at **no charge** to you. All Mack Parts and Service Centers have been sent a bulletin covering all the details required to perform the safety recall.

You can locate the closest Mack Parts and Service Center by going on line to <http://www.macktrucks.com/> and selecting "Dealer & Service Locations" or by calling our toll-free number: (800) 866-1177.

**NOTICE REGARDING  
LEASED VEHICLES:**

If you are a Lessor of vehicles subject to this Notice, you have an obligation under Federal Law to provide a copy of this Notice to all Lessees within 10 days of your receipt of this Notice. Further, you must maintain a record, which identifies the Lessee(s) to whom you send a copy of this letter, the date you send this letter, and the Vehicle Identification Number(s) of the vehicle(s) that you have leased to that lessee. For purposes of this Notice, the term Lessor means: a person or entity that is the owner, as reflected on the vehicle's title, of any five or more leased vehicles (as defined in CFR Section 577.4), as of the date of notification by the manufacturer of the existence of a safety-related defect or non-compliance with a Federal Motor Vehicle Safety Standard in one or more of the leased motor vehicles.

**OWNER RECALL  
RESPONSE CARD:**

The enclosed "Notice of Vehicle Recall" identifies your vehicle. If you no longer own the vehicle, please help us update our records by completing the "Vehicle Disposition Record" portion of the enclosed postage-free Notice of Mandatory Safety Campaign card and mailing it back to us.

**ASSISTANCE/  
COMPLAINTS:**

If your vehicle has not been repaired within a reasonable time after delivering it to a Mack Parts and Service Center, please contact:

Mack Trucks Inc.  
Regulatory Affairs Department,  
P.O. Box 26115  
Greensboro, NC 27402-6115  
[vtna.regulatoryaffairs@volvo.com](mailto:vtna.regulatoryaffairs@volvo.com)

You may also submit complaints to the Administrator of the National Highway Safety Administration (1200 New Jersey Avenue, S.E., Washington DC 20590 or call the toll-free Auto Safety Hot Line at 1-888-327-4236 (TTY: 1-800-424-9153), or go to <http://www.safercar.gov> if you believe that Mack Trucks Inc. has failed to remedy the defect without charge, or has failed to remedy the vehicle within 60 days of the owners first tender to obtain repair following the earliest time that parts are available.

**PRE NOTIFICATION  
REMEDIES:**

If you have previously paid for repairs as a result of this issue, you may be entitled to recovery of those expenses.

Submit copies of all documentation supporting your claim according to the rules specified in the "General Plan for Reimbursement of Pre-notification Remedies" provided in this mailing.

We regret any inconvenience this may cause to your operation, but hope you will appreciate our sincere efforts to demonstrate Mack's commitment to provide our customers with the best possible product.

**MACK TRUCKS, INC.**

An inspection of the six high-pressure fuel injection lines must be performed each day during the normal pre-trip inspection, fluid level check, etc. Inspect the fuel lines as follows:

1. Before starting the engine, open the hood and inspect the six high-pressure fuel lines for signs of fuel leakage. This inspection must include the injection line itself, as well as both ends of the line at the cylinder head connection and the Electronic Unit Pump (EUP) connection. Refer to the following illustration.

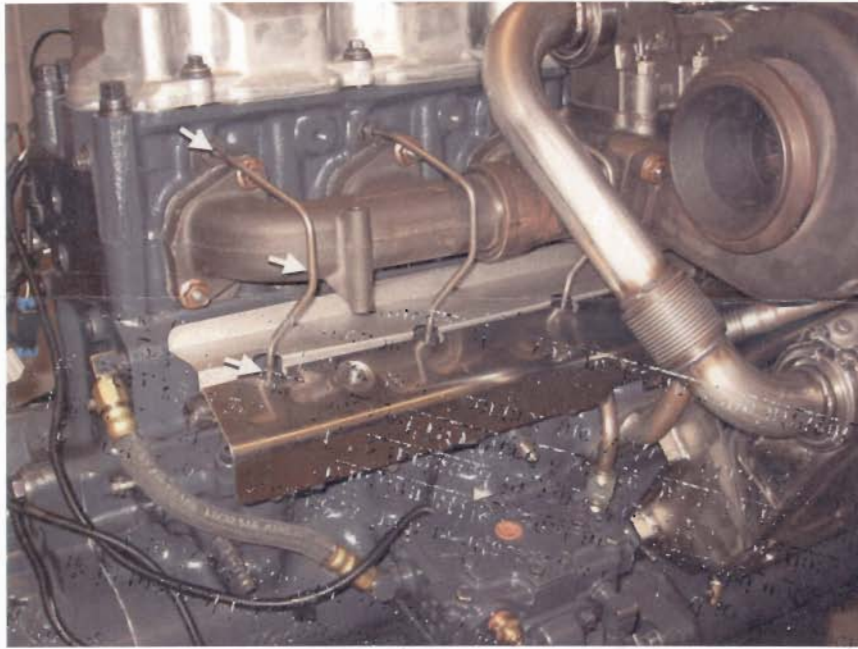

Figure 1 — ASET™ AC High-Pressure Fuel Injection Lines

2. If no leaks are found, keep the hood open and start the engine. If leaks are seen, DO NOT proceed, and DO NOT operate the vehicle. Call your local MACK dealer or the MACK OneCall™ CompleteCare center for further instructions.
3. Allow the engine to idle approximately 5 minutes, and then shut the engine off.

**⚠ WARNING**

**DO NOT go near the right-hand side of the engine where the fuel injection lines are located during this short run time, as fuel leakage could be at very high pressure.**

4. With the engine shut off, recheck the six high-pressure fuel lines as described in step 1. If no leaks are seen, proceed with the remainder of the pre-trip inspection and subsequent normal operation of the vehicle.

If leakage is seen or suspected, DO NOT OPERATE the vehicle. Contact your local MACK dealer or the MACK OneCall™ CompleteCare center for further instructions.

**⚠ DANGER**

***Vehicle owners must make the driver(s) aware that if fuel is smelled during operation, the vehicle must be stopped immediately in a safe location and the fuel lines must be inspected. If leakage is seen or suspected, DO NOT OPERATE the vehicle. Contact your local MACK dealer or the MACK OneCall™ CompleteCare center for further instructions.***

## **General Plan for Reimbursement of Pre-Notification Remedies**

Mack Trucks Inc. will administer this plan through its Corporate Regulatory Compliance Department.

The provisions of this plan set forth the procedures to be followed for reimbursing owners (claimants) for the costs associated with repairs performed prior to notification of a recall, to remedy safety defects and non-compliances.

### **Required Information:**

If the claimant's Mack vehicle is affected by a recall campaign and the claimant had the problem corrected at their own expense prior to receiving notification of the recall, Mack Trucks will reimburse the claimant by check for the reasonable amount paid for the appropriate pre-remedy repairs (i.e. the cost of parts, labor, taxes and disposal fees) in accordance with the provisions set forth in this document. In order to process each claim, the claimant **MUST** submit the following documentation to support the request to the Regulatory Compliance Department as specified in the section titled "*Contact Information*":

- Claimant's name, mailing address, and telephone number; and,
- The recall number, title, and description; and,
- The complete 17 digit Vehicle Identification Number (V.I.N.); and,
- A notarized statement by the claimant that the pre-notification repair addressed the defect specified in the owner notification letter; and,
- A copy of the repair invoice or receipt for the repairs.
  - The invoice / receipt must provide the VIN, total amount paid (i.e. total amount of reimbursement requested by the claimant), and include a breakdown of the parts, labor, and other costs.

### **Limitation of Claims**

Mack Trucks will consider all claims, but may deny all or part of the claim for any of the following reasons:

- The vehicle was not part of the recall;
- The repairs were performed more than one (1) year prior to the date, that Mack Trucks notified the National Highway Traffic Safety Administration or Transport Canada, that a safety related defect or non-compliance exists;
- The repairs were performed more than 10 calendar days after the last mailing of the initial customer notification letter, pertaining to the recall;
- The vehicle was still covered by warranty or extended warranty on the date of repair which would have provided a free repair;
- If the receipt / invoice is not itemized by parts & labor;
- If the repair did not address the safety defect or non-compliance that led to the recall;
- If the repair was not reasonably necessary to correct the safety defect or non-compliance that led to the recall;
- If the claim is fraudulent;
- If the repair was not of the same type (repair, replacement, and refund) as the recall remedy;
- If adequate documentation as described above is not submitted to the appropriate address specified in this plan in the section titled "*Contact Information*".

### **Contact Information**

Submit copies of all documentation supporting your claim to:

Mack Trucks Inc.

Regulatory Compliance Department

Attn: Regulatory Compliance Administrator

P.O. Box 26115

Greensboro, NC 27402-6115

**Claims will be processed within 60 days of receipt**