

# DAIMLER

Daimler Trucks North America  
Nasser Zamani  
Manager  
Compliance and Regulatory Affairs

January 21, 2008

Dan Smith  
Associate Administrator for Vehicle Safety  
National Highway Traffic Safety Administration  
1200 North Jersey Avenue S.E.  
Washington D.C. 20590

## **Re: Defect Information Report – Supplemental Report No. 4 07V-212, FL-496, TBB Warning Light Malfunction**

Mr. Smith

In accordance with Part 573 of Title 49 of the Code of Federal Regulations, Daimler Trucks North America LLC herewith submits supplemental defect information and copies of documents to be distributed to dealers and purchasers.

**(c)(2) Vehicles identification:**

**Manufacture Dates:** December 1, 2003 through May 14, 2007  
**Basis for determining population:** All Saf-T-Liner C2 buses built December 1, 2003 through May 14, 2007  
**Component manufacturer if other than the vehicle manufacturer:** Not Applicable

**(c)(3) Total number of vehicles potentially affected:** 9,970

**(c)(8) Remedial program:** The repair consists of performing Product Service Bulletin C2 Bul 2 Ind 13 – “Improved Air Door Control Operation.” Repairs will be performed by Thomas Bus dealerships and Direct Warranty customers, i.e., customers approved by Thomas Bus to do their own warranty repairs.

**Communications sent to dealers:** posted January 18, 2008

**Communications sent to owners:** mailed January 21, 2008

**(c) (9) Copies of Communications sent to owners and dealers are attached.**

Please contact me if you have any questions.

Sincerely yours,

  
Nasser Zamani

Cc: Michael Mason, CAL-OSHA  
Enclosure  
Certified Mail# 7006 3450 0003 8408 4783



A Subsidiary of **FREIGHTLINER**  
CORPORATION

## Product Recall

---

To: ALL DEALERS

From: TRACY SAUERBREY – WARRANTY/RECALL DEPARTMENT

Subject: RECALL 07V-212 – Saf-T-Liner C2 Door Switch

Date: January 16, 2008 (UPDATE – PLEASE DISREGARD PREVIOUS LETTER DATED DEC. 10, 2007)

Enclosed are copies of the customer notification letter and the repair procedure for Recall 07V-212. This recall involves certain Saf-T-Liner C2 vehicles manufactured between December 1, 2003 and May 14, 2007. The defect involves the entrance door operation and its effect on the traffic control warning devices (lights and stop arms). There is a possibility that these warning devices will deactivate if the entrance door shuts without notice.

This is a universal notification sent to all dealers. You may or may not have customers in your area affected by this recall. If owners in your area are subject to this recall, we have enclosed a printout listing those customers' names and addresses. Please note: **there have been some additional units added to the recall due to the date range change. You will also have an updated printout.** If there is not a printout enclosed according to our records there are no units in your area involved. **If you have a printout and any of the units on it are still in your possession it is your responsibility to ensure the recall is performed before the unit is delivered to the customer.**

The repair will consist of performing Product Support Bulletin C2 Bul 2 Ind. 13 Improved Air Door Control Operation. The labor allowance will be 1.5 for the complete PSB (SRT 64-113) or .5 for air plumbing only (step 2.1-2.11. SRT 64-106). You will need to order individual part numbers as listed on PSB C2 Bul. 2, Ind. 13 from the Parts Distribution Center. Proceed with placing orders for parts needed, however not all parts will be readily available at the time of this notification. NOTE: When inputting your claim for this recall the failure information will auto populate. You will NOT code the claim as a PSB, it will need to be a RECALL claim. There should just be one claim per unit for this recall and it will be for performing PSB C2 Bul. 2 Ind. 13 only.

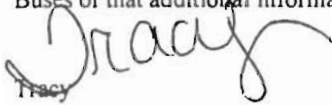
Attached to this recall you will also find the following PSBs. These PSBs are not part of the recall, however they are highly recommended as a product improvement.

PSB Ind. C2 5 Bul. 7 Switch Hub Module Repositioning  
PSB Ind. C2 5 Bul. 8 Switch Bank To Switch Harness Conversion  
PSB Ind. C2 5 Bul. 9 Body (PDM) Power & Ground Cable Routing Improvement  
PSB Ind. C2 2 Bul. 14 manual Vandalock Installation

NOTE: When filing a claim for any of the four PSBs listed above please file as a PSB claim, not a recall claim.

Thomas Built Buses has elected to notify all customers directly. Your customers will be contacting you to schedule an appointment for repairs. Reimbursement for parts and labor, (if requested) may be obtained by filing a warranty claim.

If you know of any customers who own or operate a Thomas bus in this recall, whose name and address is NOT listed or is INCORRECTLY listed on the enclosed printout, please promptly notify Thomas Built Buses of that additional information in writing. Thank you for your cooperation and assistance.

  
Tracy

Enclosures: Customer Letter Repair Procedure Printout (if applicable)



A Subsidiary of **FREIGHTLINER**  
LLC

January 18, 2008

Recall 07V-212

This notice is sent to you in accordance with the requirements of the National Traffic and Motor Vehicle Safety Act. Thomas Built Buses, Inc. has decided that a defect which relates to motor vehicle safety exists on certain Saf-T-Liner C2 vehicles manufactured between December 1, 2003 and May 14, 2007. These units are identified on the enclosed postcard (Form PSD 304).

The defect involves the entrance door operation and its effect on the traffic control warning devices (lights and stop arms). The operation of the traffic control warning devices are controlled by the operation of the door, utilized during the loading/unloading process. There is a possibility that these warning devices will deactivate if the entrance door shuts without notice. Failure of the warning lights to remain on during the loading/unloading process may result in motorists passing the school bus. A student may be struck while boarding or exiting the bus possibly resulting in injury or death.

You should immediately contact your Thomas Built Buses dealer for an appointment to have your vehicle modified. Thomas will remedy this defect without charge. The remedy will consist performing one or more of released Product Support Bulletins pertaining to the door control. It will take up to a maximum of 1.5 hours for repairs per unit, according to which repairs are needed. To arrange for repairs, contact your local Thomas Built Buses dealer. After the repair is made, please complete each postage paid card separately and return it to Thomas Built Buses to verify completion.

In addition to being used to verify repair completion, the postcard must be completed and returned if the vehicle does not need repair, if you no longer own the vehicle, or the vehicle identified on the postcard has been exported, stolen, or destroyed/totaled. Federal law requires that any vehicle lessor receiving the recall notice must forward a copy of this notice to the lessee within 10 days.

If you have had your vehicle repaired due to this noncompliance prior to receipt of this notice and you have incurred any costs, you may be eligible for reimbursement. For further information, please contact the Warranty/Recall Department at (336) 822-2871, 8 a.m. to 5 p.m. eastern standard time Monday through Friday, e-mail [Tracy.Sauerbrey@thomasbus.com](mailto:Tracy.Sauerbrey@thomasbus.com).

If the defect is not remedied without charge and within a reasonable time, which is not longer than 60 days after you tender the vehicle for repair, also please contact the Warranty/Recall Department at (336)-822-2871. You may also submit a complaint to the Administrator, National Highway Traffic Safety Administration, 1200 New Jersey Avenue, SE, Washington, DC 20590, or phone the Vehicle Safety Hotline at 1-888-327-4236 (TTY: 1-800-424-9153) or go to <http://www.safercar.gov>. If your vehicle is involved in the Canadian portion, you may notify the Manager, Recall and Public Compliance, Road and Motor Vehicle Traffic Safety Branch, Transport Canada, Ottawa, Ontario or phone (613)-993-9851.

Sincerely,

Tracy Sauerbrey  
Warranty/Recall Department

Enclosure



## BODY

MODEL: C2

SUBJECT: IMPROVED AIR DOOR CONTROL OPERATION

DATE: JANUARY 16, 2008

INDEX: C2 2

PAGE: 1 OF 7

BULLETIN: 13R

This bulletin supercedes Index C2 2, Bulletin 13 to change the unit effective start dates for **Steps 1.1-1.4 to 12/1/03 through 4/18/06**. The effective start dates for **Steps 2.1-2.11 are 4/18/06 through 5/14/07**. An Elbow Fitting, #TBB 69008054 has been added to accomodate the new valve. See **Step 2.8.a and 2.8.b**. Also, added #TBB 100306 and #TBB 100036 to the parts list.

This service bulletin provides a procedure to improve the operation of the air door control. This bulletin will obsolete PSB Index C2 2, Bulletin 3, Index C2 5, Bulletin 5, and Index C2 5, Bulletin 6.

**Important: If your unit is equipped with the Viking valve, perform the complete bulletin. If your unit is equipped with the GT valve, perform the procedure starting with Step 2 on page 4.**

1. The information in steps 1.1-1.4 is only for doors with the Viking valve. (Figure 1) This valve was used on units with start dates from 12/1/03 through 4/18/06.

1.1 Routing Harness:

- Remove the following panels and trim: Panel over the driver's window, trim behind the driver's window, metal panel beneath the switch cabinet, the switch panel and the splash shield located under the switch panel to enable access to the Cab PDM (Power Distribution Module) and the SHM (Switch Hub Module).
- Route Harness Overlay, #TBB 125811, and secure. **Figure 2**
- Insert ground circuit over driver's window. **Figure 3**

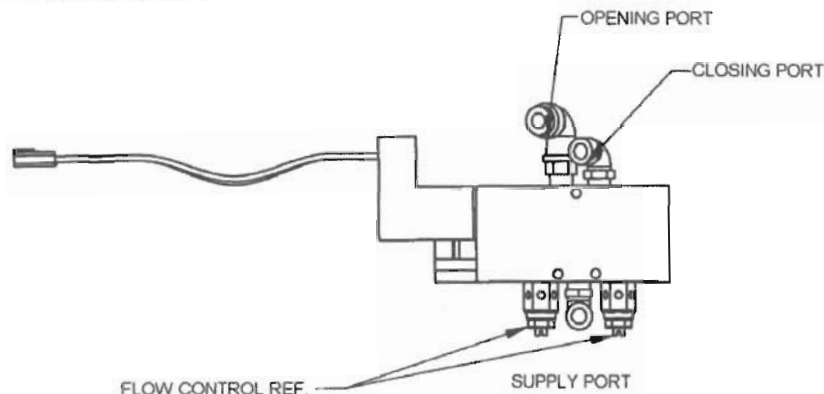


Figure 1

1.2 Wire Cab PDM: **Figure 4**

- Connect the circuits to the Cab PDM as shown.

**Note: You may need to remove a circuit from the connector, if so secure and tie out of the way.**



Figure 2

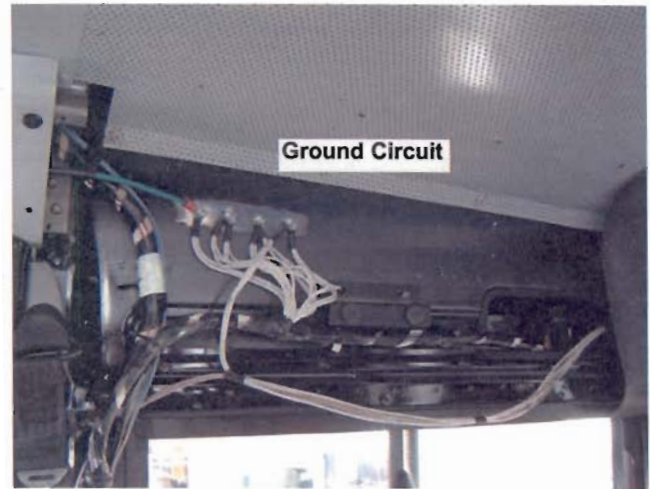
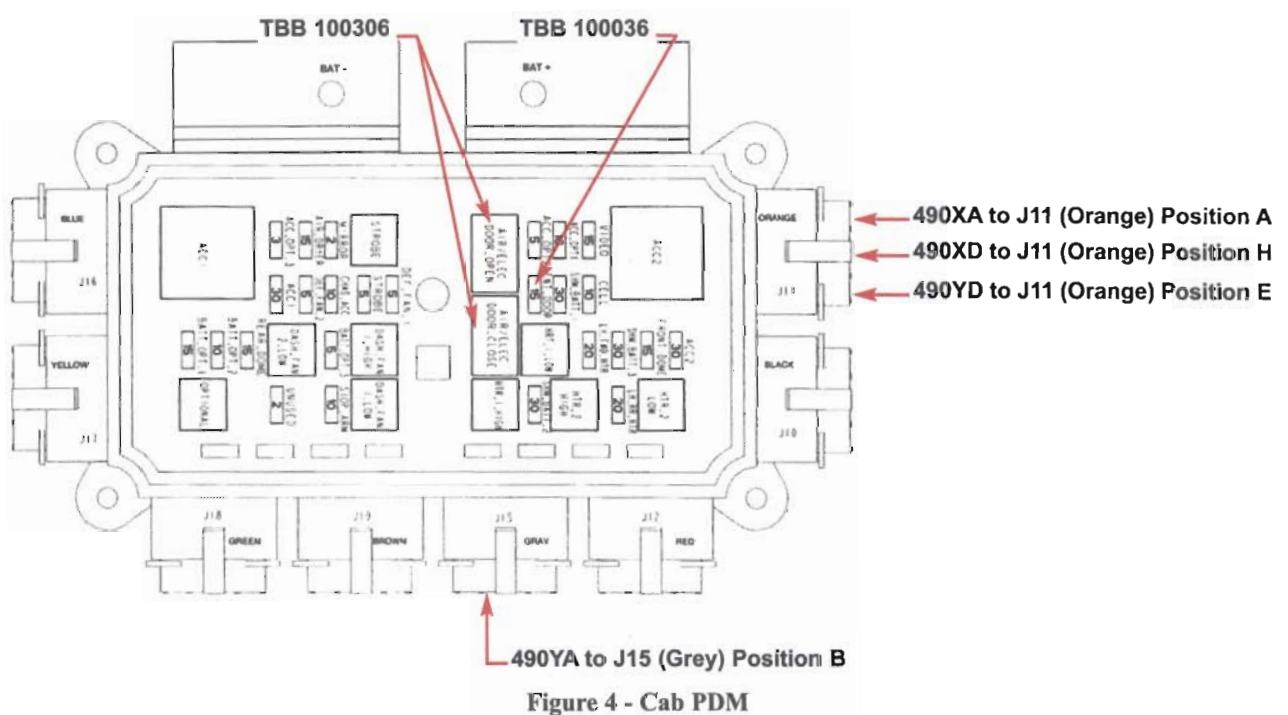


Figure 3

1.3 Connect SHM Figure 5



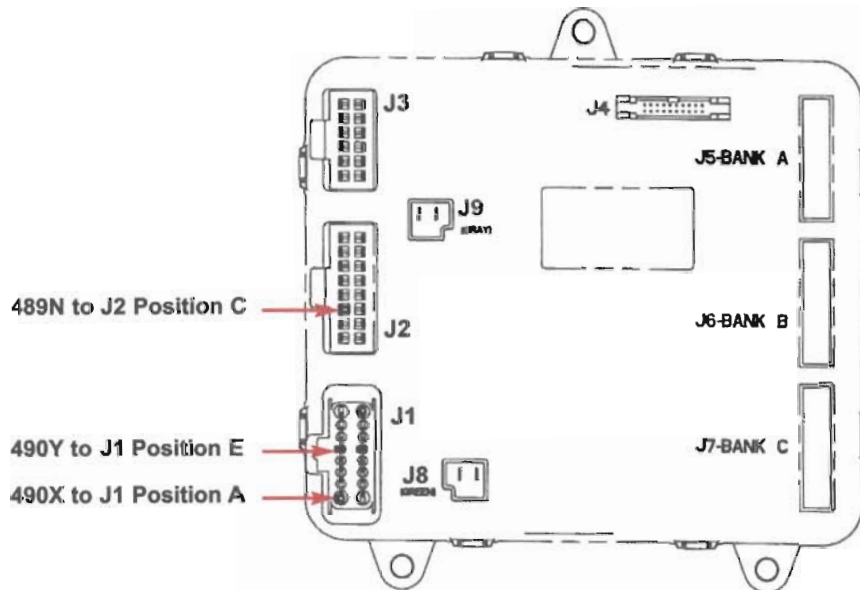


Figure 5 - Switch Hub Module

1.4

Downloading Updates:

- a. Once in Service Link, choose "Bulkhead Module" category from the ECU list.
- b. Choose the "Features" tab.
- c. If there are any RPN's displayed in the pop-up dialog box, you need to update.
- d. At this point, the user will be prompted to download the updates.
- e. If no updates, verify which RPN the unit has for the operation of the door.
- f. See the chart below for the crossover reference only.
- g. Enter the correct RPN to add to the unit.
- h. On general information, synchronize with the host.

PARAMETER #	REPLACED WITH	DESCRIPTION
26-02045-000	None	Entrance door control disabled
26-02045-001	26-02045-024	Air Dr, Bat, 2 Pos, w-Buz, w-Ext Dr Ctrl, w-o Pwr Dn, w/o Mot Int
26-02045-002	26-02045-024	Air or Electric Dr, Bat, 2 Pos, w-Buz, w-o Ext Dr Ctrl, w-o Pwr Dn, w-o Mot Int
26-02045-003	26-02045-025	Air Dr, Bat, 3 Pos w-Emg Ovr, w-Buz, w-Ext Dr Ctrl, w-o Pwr Dn, w-o Mot Int
26-02045-004	26-02045-025	Air Dr, Bat, 3 Pos w-Emg Ovr, w-Buz, w-o Ext Dr Ctrl, w-o Pwr Dn, w-o Mot Int
26-02045-008	26-02045-026	Air Dr, Bat, 3 Pos SS w-Warn Emerg Ovr, w-o Buz, w-5 sec sleep, w-o Mot Int
26-02045-009	26-02045-026	Air Dr, Bat, 3 Pos SS w-Warn Emerg Ovr, w-o Buz, w-5 sec sleep, w-o Mot Int

2. **If your unit is equipped with the GT Valve, perform the remainder of this bulletin. (Figure 6) These changes affect units with start date of 4/18/06 through 5/14/07.**

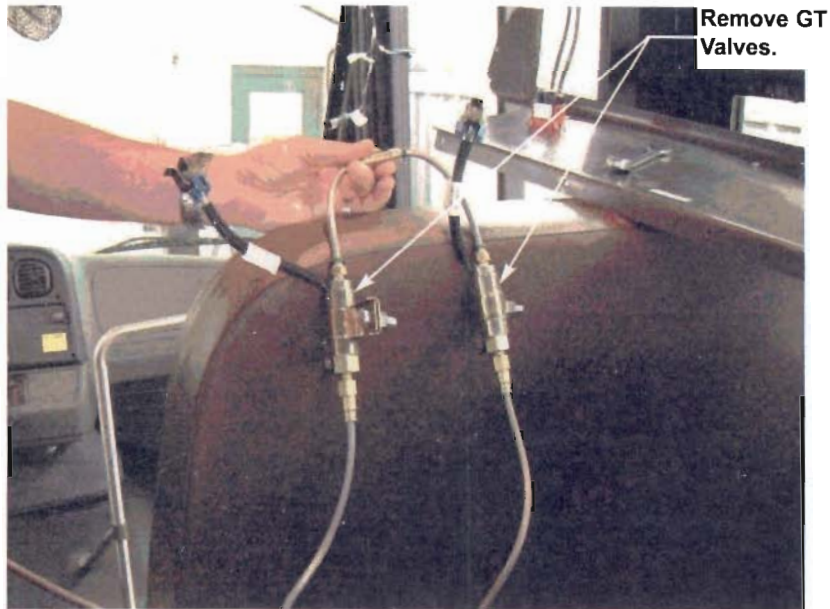


Figure 6

- 2.1 Remove access cover. **Figure 7**  
2.2 Disconnect harnesses and air lines. **Figure 8**



Figure 7

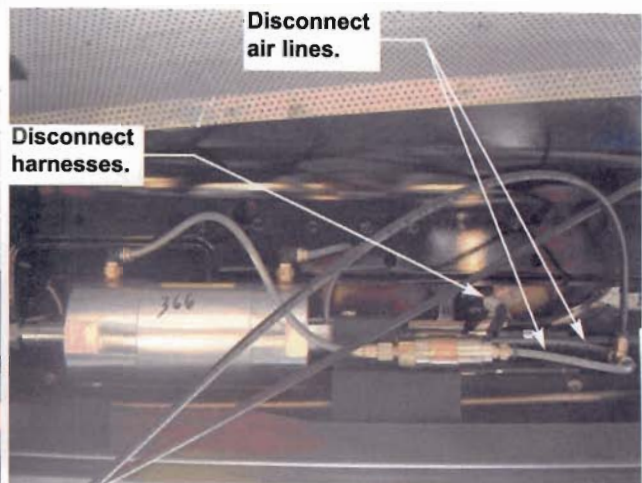
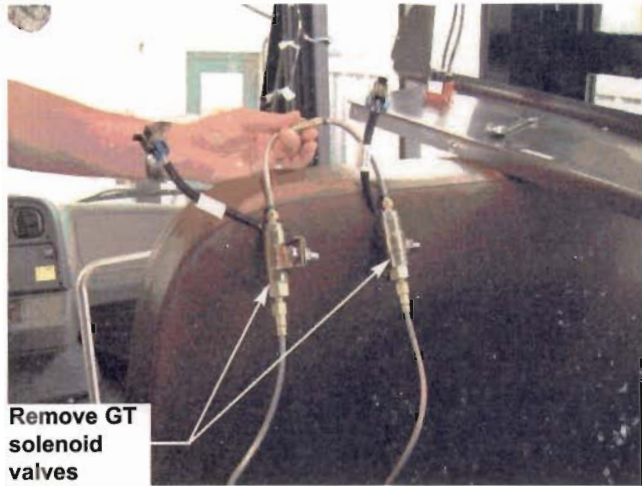


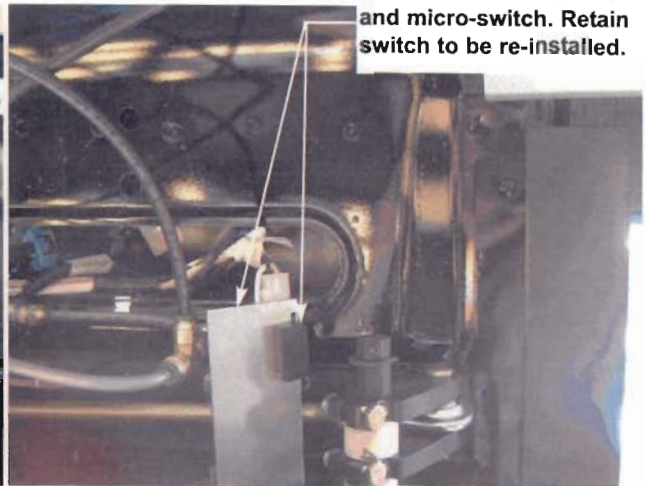
Figure 8

- 2.3 Remove solenoid valves. **Figure 1 and Figure 9**  
2.4 Remove existing switch bracket and micro-switch. **Figure 10**



Remove GT solenoid valves

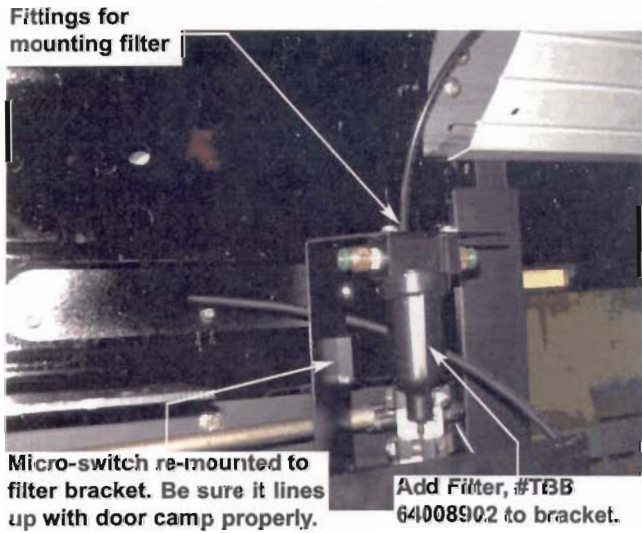
Figure 9



Remove switch bracket and micro-switch. Retain switch to be re-installed.

Figure 10

- 2.5 Re-assemble micro-switch to Filter Bracket, #TBB 116536. **Figure 11**
- 2.6 Attach Inline Air Filter, #TBB 64008902 and #8 Flatwasher, #TBB 69004271, #8 Lockwasher, #TBB 61370346 and Machine Screw, #8-32 x .50, #TBB 61370396. **Figure 11**
- 2.7 After you have removed the valve assembly as shown in **Figure 1**, drill new holes in the mounting plate to accommodate the Parker Valve Assembly, #TBB 136969. **Figure 12**

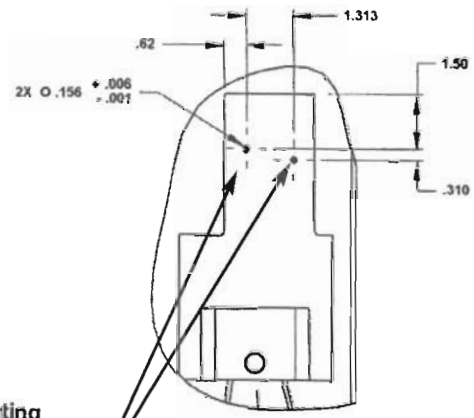


Fittings for mounting filter

Micro-switch re-mounted to filter bracket. Be sure it lines up with door camp properly.

Add Filter, #TBB 64008902 to bracket.

Figure 11

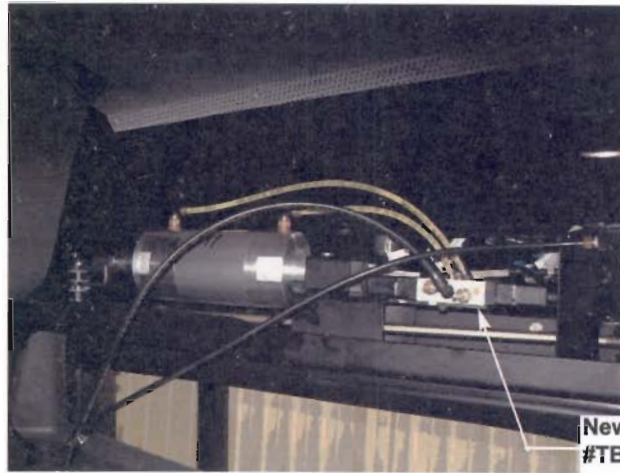


New mounting locations for Solenoid Valve, #TBB 136969.

TOP VIEW  
DRILL PATTERN  
SOLENOID VALVES REMOVED  
FOR CLARITY  
SCALE 0.375

Figure 12

- 2.8 Assemble new Solenoid Valve, #TBB 136969 using Machine Screw, 6-32 x 1.25, #TBB 69002253 and Nylon Locknut, 6-32, #TBB 69004247. **Figures 13 & 14**
  - a. Remove the Opening Port fitting, and discard.
  - b. Install new Elbow Fitting #TBB 69008054 for the new valve to accommodate the 1/4 tubing.



New Solenoid Valve Assembly,  
#TBB 136969

Figure 13

- 2.9 Re-attach airlines and electrical connections. Connect Wiring Harness, #TBB 136539 to make your electrical connections.
- 2.10 Check connections and adjustment of the door. Re-adjust micro-switch as needed for proper function of the door.
  - a. Adjust Flow Control to meet 3-4 second open time and closing time of door. **Figure 14**
  - b. Loosen Jam nut on upper Exhaust Port ("Door Close"). Tighten screw then back off ¼ turn. Tighten jam nut.
  - c. Loosen Jam nut on lower Exhaust Port ("Door Open"). Tighten set screw then back off ½ turn. Tighten Jam nut.
- 2.11 Re-attach the cover.

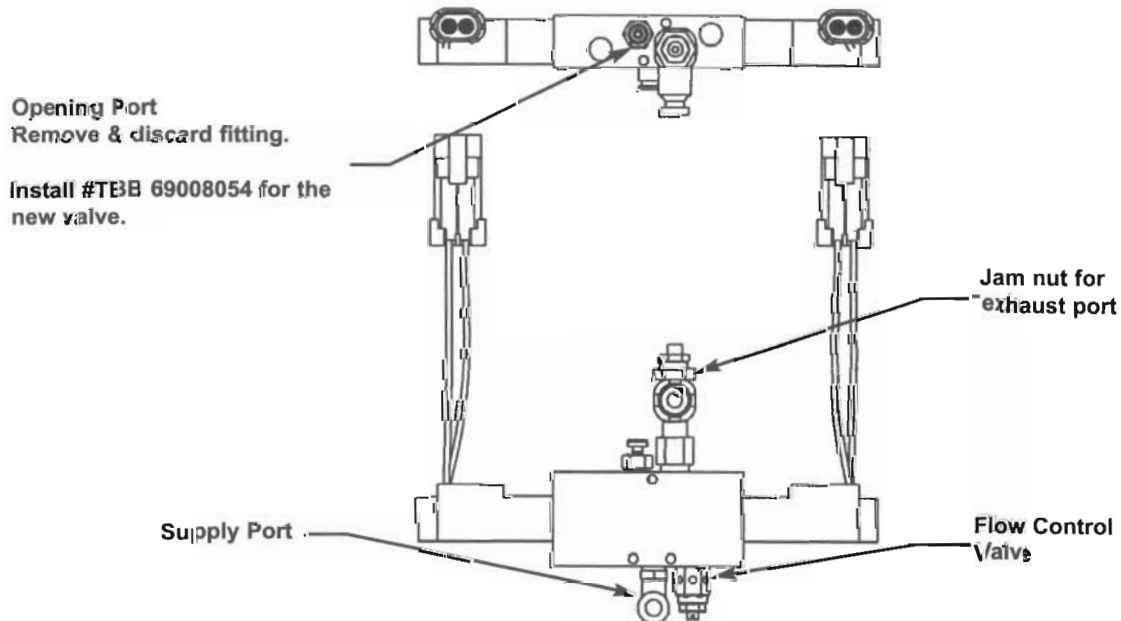


Figure 14

**MATERIALS REQUIRED:**

<b><u>PART NUMBER</u></b>	<b><u>QTY.</u></b>	<b><u>DESCRIPTION</u></b>
TBB 136969	1	Solenoid Valve, Assembled Pneumatic
TBB 69008054	1	Fitting, Elbow Quick Connect 18 x 1/4, Air Line
TBB 69002253	2	Machine Screw, 6-32 x 1.25
TBB 69004247	2	Nylon Locknut, 6-32
TBB 136539	2	Wiring Harness, Service Door Interface
TBB 116536	1	Filter Bracket
TBB 100306	2	Relay, Micro 280 SPDT 5 Pin
TBB 100036	1	Mini Fuse, Blade Style, 20 Amp, Fast Acting
TBB 69004271	2	Washer, Flat No. 8
TBB 61370346	2	Washer – Lock #8
TBB 61370396	2	Machine Screw, #8-32 x .50
TBB 64008902	1	Filter, Air, Inline
TBB 125811	1	Harness Overlay, AG2 Air Operated Ent. Door, C2 ( <b>Harness to be used with Viking valve only</b> )

**WARRANTY STATUS:**

WITHIN PROVISIONS OF TBB WARRANTY - REFER TO RECALL 07V-212

**WARRANTY CODE:** 7512**SRT CODE:** 64-113, TIME ALLOWANCE - 1.5 HRS. FOR THE COMPLETE PSB.**SRT CODE:** 64-106, TIME ALLOWANCE - 0.5 HR. FOR AIR PLUMBING ONLY (STEP 2.1-2.11)**QC:** X09

**MODEL:** C2

**SUBJECT:** MANUAL VANDALOCK INSTALLATION

**DATE:** JANUARY 16, 2008

**INDEX:** C2 2

**PAGE:** 1 OF 3

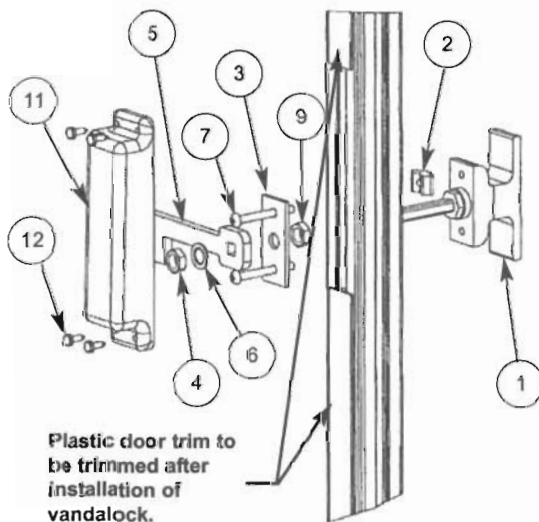
**BULLETIN:** 14R

This bulletin supercedes Index C2 2, Bulletin 14 to change the unit start of production dates to 12/1/03 through 5/14/07.

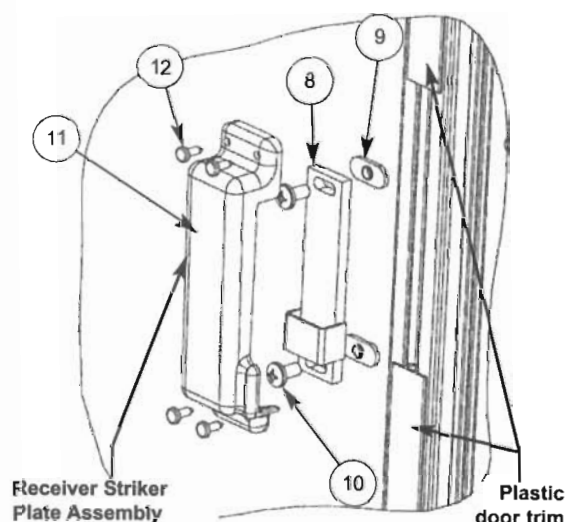
This service bulletin affects units built without Option #D3039-06-000 Entrance Door Vandalock, units that have Exterior Electrical Key Control (which TBB recommends to be taken out), or when Customers elect to install with the manual vandalock. Units with start dates beginning 12/1/03 through 5/14/07 are affected. This bulletin, along with Index C2 2, Bulletin 13 obsoletes Index C2 5, Bulletin 6.

The following procedure will outline how to install the Manual Vandalock.

1. If exterior electrical key control exists disconnect it before proceeding to step 2.
2. Remove vertical plastic snap-in trim on inside of both door leaves; center extrusion only. Retain to be re-installed. **Figures 1 & 2**

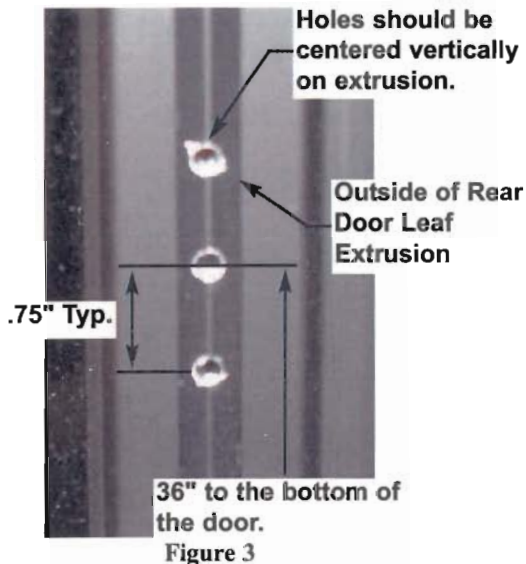


**Figure 1**



**Figure 2**

3. Measure 36" up from the bottom of the door extrusion. This will be the center hole location. Drill three (3) 7/32" holes completely through door extrusion, outside of rear door leaf only. **Figure 3.**
4. Enlarge the center hole with 1/2" drill bit (**Figure 4**) through the extrusion. Countersink a 7/8" hole through the outside wall of extrusion only. This will be for the "T" handle, #TBB 64008918.
  - a. Check fit by inserting the handle. Make sure the handle fits flush against the extrusion. If it does not, remove more material.



5. See **Figures 1 & 2** for assembly of the door handle and cover to extrusion.
  - a. Make sure handle will rotate 90° to the right to lock door.
  - b. Do **not** tighten the Jam Nut, #TBB 61370061 against Mounting Plate, #TBB 64008906.
6. The receiver Striker Plate Assembly, #TBB 121567 for the forward leaf is outlined in **Figure 2**.
7. While on the inside of the bus, have someone lock the door. Adjust the Striker Plate horizontally and vertically so the Pawl, #TBB 121564 fits into receiver as shown. **Figure 5**
  - a. After desired position is achieved, tighten the Machine Screws, #TBB 69002167 holding the Striker Plate Assembly. **Figure 5**



## BULLETIN: 14R

8. Install the two (2) plastic Pawl Covers, #TBB 64008950 pictured in **Figures 1 & 2**.
  - a. **Note: Be sure to position the Covers so they do not interfere with the operation of the latch.**  
Trim cover as needed to fit.
  - b. Drill holes for the Covers with a #27bit. Fasten Covers using #8 Tapping Screws, #TBB 121595.
9. Cut plastic trim to fit and reinstall in the extrusion. See **Figures 1 & 2**.

**MATERIALS REQUIRED:**

<b><u>ITEM #</u></b>	<b><u>PART #</u></b>	<b><u>QTY.</u></b>	<b><u>DESCRIPTION</u></b>
1	TBB 64008918	1	T Handle, Vandalock, Front Door
2	TBB 64008998	1	Trim, Vandalock, Alum. Front Door
3	TBB 64008906	1	Mounting Plate, Vandalock
4	TBB 61370061	2	Nut, Hex-Jam, 3/8 - 24
5	TBB 121564	1	Pawl, Vandalock
6	TBB 121597	1	Internal Lock Washer, 3/8"
7	TBB 69002287	2	Screw, #10-32 x 1 13/16" Round Head
8	TBB 121567	1	Striker Plate Assembly
9	TBB 69004112	2	Nut - Spotweld, Dual Tab
10	TBB 69002167	2	Screw - Machine, 1/4 - 20 x 1/2" Phillips Pan Head
11	TBB 64008950	2	Cover, Interior Vandalock Pawl
12	TBB 121595	8	Screw, Tapping #8 x .50
N/S	TBB 67000774	1	Key, Single Bitted ( <b>not shown</b> )

**WARRANTY STATUS:**

WITHIN PROVISIONS OF TBB WARRANTY

**ELECTRONIC WARRANTY CODE: 7511****SRT CODE: 64-114, TIME ALLOWANCE - 0.7 HR.****QC: X09**



## BODY

**MODEL:** C2

**SUBJECT:** SWITCH HUB MODULE REPOSITIONING

**DATE:** JANUARY 16, 2008

**INDEX:** C2 5

**PAGE:** 1 OF 3

**BULLETIN:** 7R

This service bulletin supercedes Index C2 5, Bulletin 7 to correct start of production dates of affected units. The effective dates are 12/1/03 through 5/14/07.

In an effort to help prevent water intrusion in the Switch Hub Module (SHM), the module is being repositioned. This will affect all units from start of production date of 12/1/03 through 5/14/07.

**Perform the following procedure to make this change.**

1. Disconnect batteries. Apply parking brake and chock tires.
2. Remove the switch panel and disconnect harness from switch hub.
3. Remove the rubber flap shown in **Figure 1**. Retain for reinstallation.
4. Using a 7/16 socket or wrench, remove the three (3) fasteners securing the SHM. **Do not** discard.
5. Making note of the harness connections, then disconnect all connectors in the switch module.



**Figure 1**

6. Install the Upper Stand-off Bracket, #TBB 139092 and Lower Stand-off Bracket, #TBB 139093 using existing fasteners removed in Step 4. Figure 2

Upper Stand-off Bracket, #TBB 139092  
Not shown.

Lower Stand-off Bracket, #TBB 139093  
Not shown.

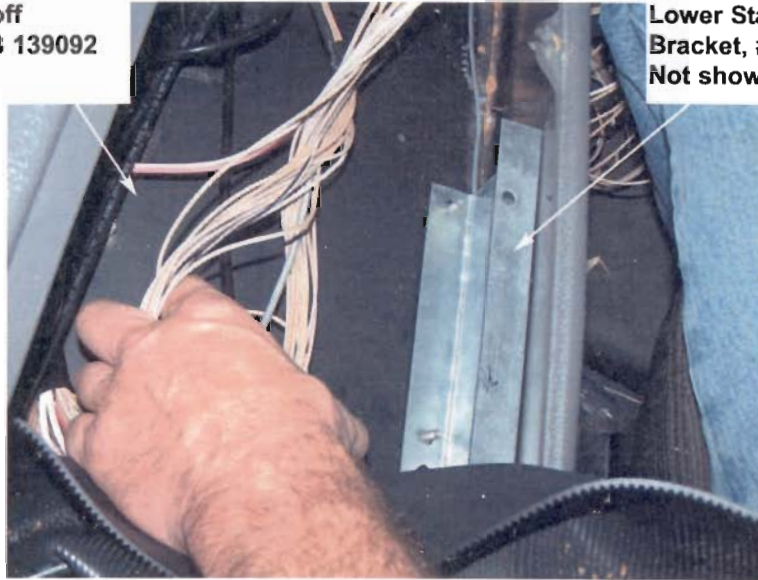


Figure 2

7. Reconnect the connectors to the SHM. See Figure 3 shows the original orientation of the SHM.
8. Rotate module 180°, installing it upside down with connectors face down, using Hex Flange Bolt, #TBB 29890014 and Hex Nut, #TBB 105826. Figure 4 shows new orientation of SHM.
9. Reinstall the rubber flap which was removed in Step 3.
10. Reinstall switch panel and harness.

Original orientation of SHM



Figure 3

New orientation for SHM  
Hex Flange Bolt, #TBB 29890014,  
Serrated Flange Hex Nut, #TBB 105826

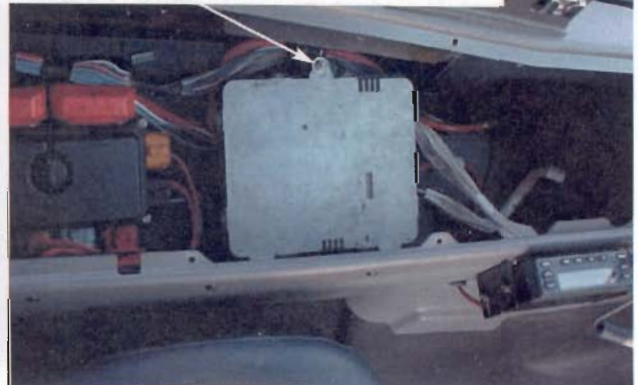


Figure 4

**MATERIALS REQUIRED:**

<b><u>PART NUMBER</u></b>	<b><u>QTY.</u></b>	<b><u>DESCRIPTION</u></b>
TBB 139092	1	Bracket, Upper Stand-off, SHM
TBB 139093	1	Bracket, Lower Stand-off, SHM
TBB 29890014	3	Bolt - 1/4 - 20 x 7/8, Hex Flange
TBB 105826	3	Hex Nut, 1/4 - 20, Serrated Flange

**WARRANTY STATUS:**

**WITHIN PROVISIONS OF TBB WARRANTY**

**ELECTRONIC WARRANTY CODE: 7554**

**SRT CODE: 52-34, TIME ALLOWANCE - 0.5 HR.**

**QC: X10**



## BODY

**MODEL:** C2

**SUBJECT:** SWITCH BANK TO SWITCH HARNESS CONVERSION

**DATE:** JANUARY 16, 2008

**INDEX:** C2 5

**PAGE:** 1 OF 3

**BULLETIN:** 8R

This service bulletin supercedes Index C2 5, Bulletin 8 to correct the body start dates to reflect all units built prior to 10/1/07.

A new Switch Harness, #TBB 130802 has been released to replace the switch bank. Units built with body start dates prior to 10/1/07, should perform the procedure in the bulletin. This bulletin obsoletes Index C2 5, Bulletin 4.

### Remove Switch Bank:

1. Disconnect Batteries.
2. Apply parking brake and chock tires.
3. Remove the six (6) screws securing the switch panel.
4. Unplug harnesses from switch banks and at the SHM. Place switch panel on work bench.
5. Remove the three (3) screws securing the switch bank to the switch panel. **Figure 1**
6. Starting at either end of the switch bank, pry switch bank away from switches. **Figure 2**



Figure 1



Figure 2

7. Reinstall pan head screws and locking nuts to fill holes left by the three (3) screws securing the switch bank. **Figures 3 & 4**



**Figure 3**

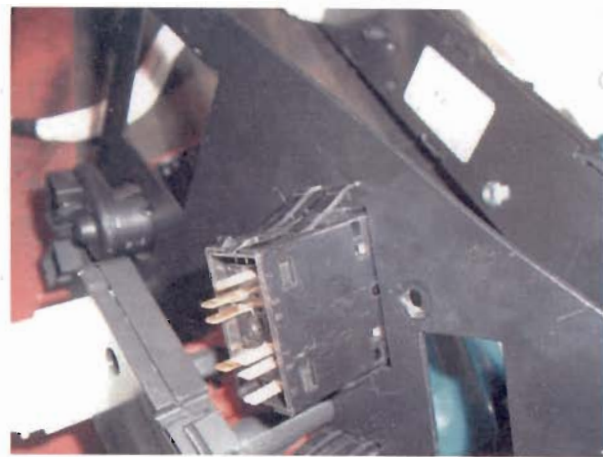


**Figure 4**

8. Using the original switches or new switches, pry switch locking tabs away from switches to secure them to the panel. **Figures 5 & 6**



**Figure 5**



**Figure 6**

**Note:** If door switch Date Code is pre-September, 2006 (0636), switch must be replaced. See Figure 7 for an example of switch and location of the date code. Any switch with a Date Code prior to 0636 needs to be replaced, i.e. 0635, 0634, etc. Also, be aware that not all switches have the Date Code printed on the side as shown in Figure 7. Some of the early switches are 'engraved' on the front side (narrow side) of the switch on the "DOOR OPEN" end.

9. Install new harness onto the switches. Figure 8

10. Repeat Steps 5-9, for each switch bank present.

11. Plug new harness into SHM, and test.

**Note:** DO NOT skip or mix switches with other locations.

12. Reinstall switch panel with existing fasteners, and verify operation.

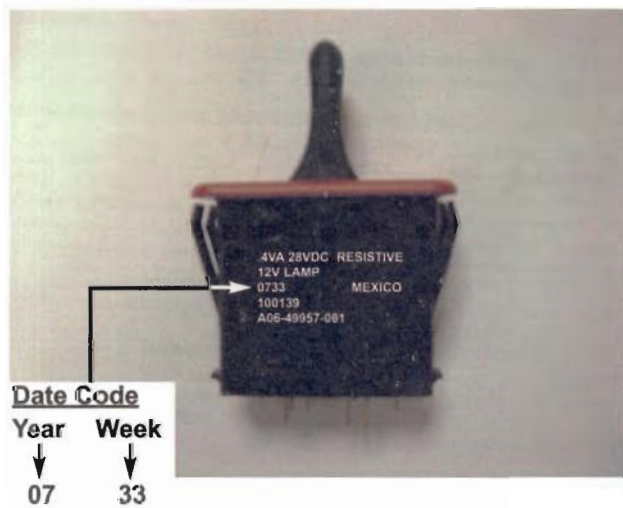


Figure 7

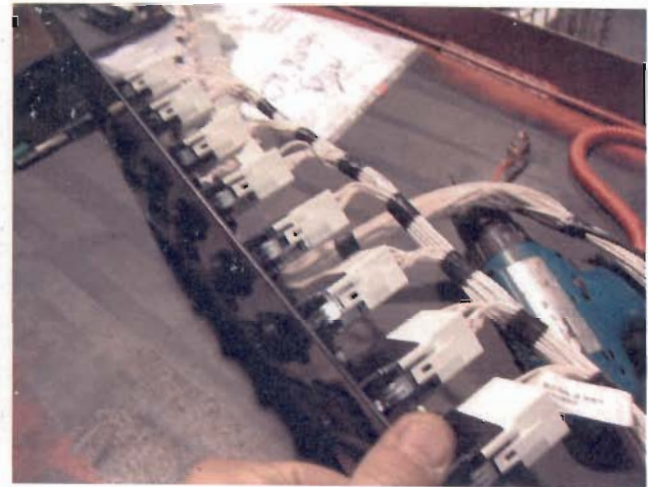


Figure 8

**MATERIALS REQUIRED:**

<u>PART NUMBER</u>	<u>QTY.</u>	<u>DESCRIPTION</u>
TBB 130802	*1	WIRING HARNESS, 8SB INTERFACE (PER ROW)
TBB 104539	1	SWITCH, DOOR PADDLE, 3-POSITION
	<u>OR</u>	
TBB 103223	1	SWITCH, DOOR PADDLE, 2-POSITION

\*NOTE: THIS NUMBER COULD BE AS MANY AS THREE, DEPENDING ON CONFIGURATION.

**WARRANTY STATUS:**

WITHIN PROVISIONS OF TBB WARRANTY

ELECTRONIC WARRANTY CODE: 7555

SRT CODE: 52-35, TIME ALLOWANCE - 0.5 HR.

QC: X10



## BODY

**MODEL:** C2

**SUBJECT:** BODY (PDM) POWER AND GROUND CABLE ROUTING IMPROVEMENT

**DATE:** JANUARY 16, 2008

**INDEX:** C2 5

**PAGE:** 1 OF 6

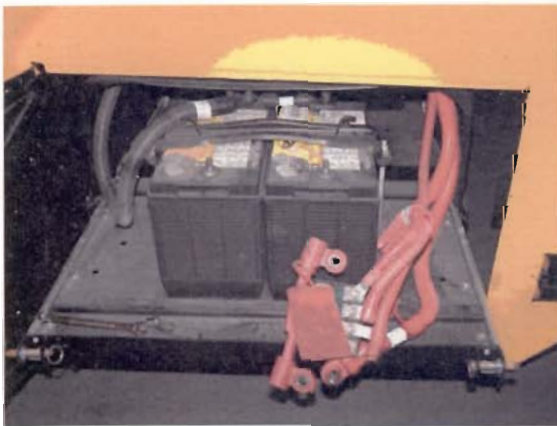
**BULLETIN:** 9R

This service bulletin supercedes Index C2 5, Bulletin 9 to correct start of production dates for affected units. These dates are 12/1/03 through 5/14/07.

The supply and return cables are currently bundled together. This service bulletin separates the PDM (Power Distribution Module) power and ground cable into independent cables, each covered in convoluted tubing, and separated with standoffs.

Units with start of production dates of 12/1/03 through 5/14/07 are affected by this bulletin.

1. Disconnect the main ground cable and then the main power cables from the battery to insure vehicle is completely disconnected from the batteries. **Figure 1**
2. Gain access to the PDM by performing the following:
  - a. Remove the driver switch plate mounting screws. **Figure 2**
  - b. Disconnect the switch attaching harnesses to allow removal of the switch panel.



**Figure 1**



**Figure 2**

- c. Remove the rubber cover, (**Figure 3**) to be reinstalled.
- d. Locate and remove the main power supply and ground return cables from the Body PDM using a 13mm socket or wrench. **Figure 4** Note any customer add-on for reinstallation.



Figure 3



Figure 4

3. Remove the lower kick and trim panels under the switch cabinet to gain access to power cable pass-thru studs. Figures 5 and 6

Kick Panel

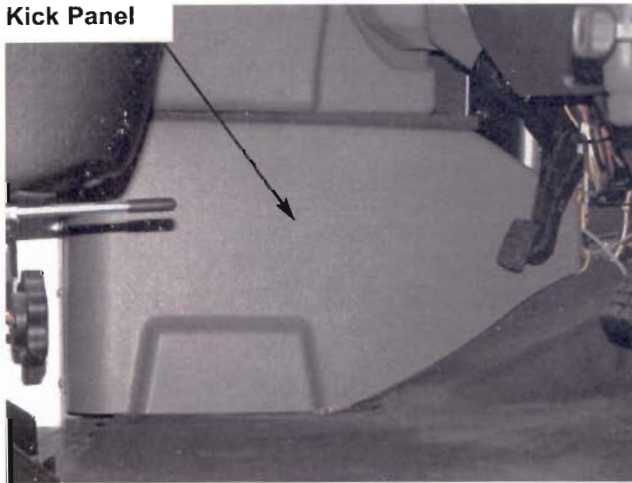


Figure 5



Figure 6

4. Remove power and ground cables from pass-thru power studs on floor. Retain fasteners. Figure 7
5. On most vehicles, there is an additional cable securing clamp that will require removal. The clamp is located on the underside of the PDM mounting platform, attached to the side plate. Figure 8.

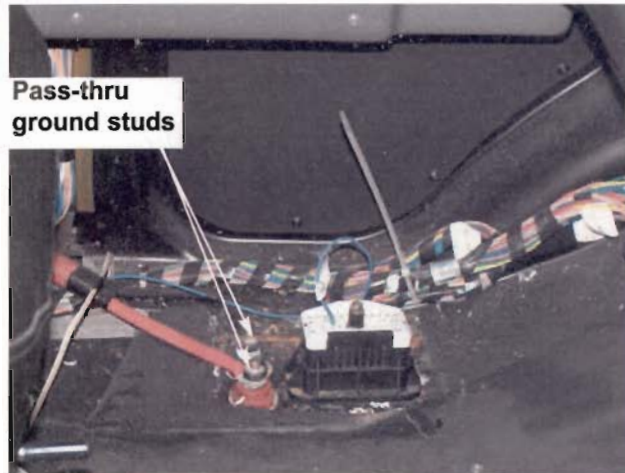


Figure 7



Figure 8

6. Remove cable from the vehicle to begin the following modifications. (Figure 9) **Note: Stock cable has the power and ground wire bundled together.**
7. Remove and discard the convoluted tubing from the cable bundle to separate the power and ground cable as shown in Figure 10.



Figure 9

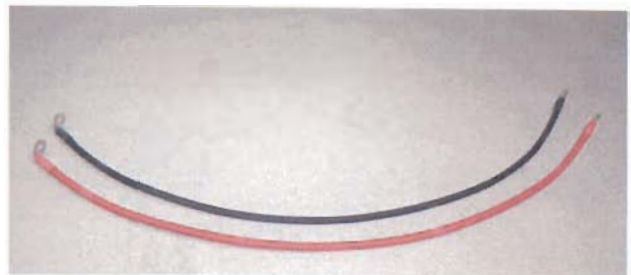


Figure 10

8. Install Black Convoluted Tubing, TBB 61202027, on black cable and Red Convoluted Tubing, TBB 61201964, on the red cable. Each cable requires approximately 39 inches of convoluted tubing. Figure 11



Figure 11

9. Install two (2) Dual Cable Clamps, TBB 61371384 and one (1) Dual Tie Wrap, TBB 61371394 as shown in **Figures 12 and 13**. See overview of completed cable assembly in **Figure 13**.



Figure 12

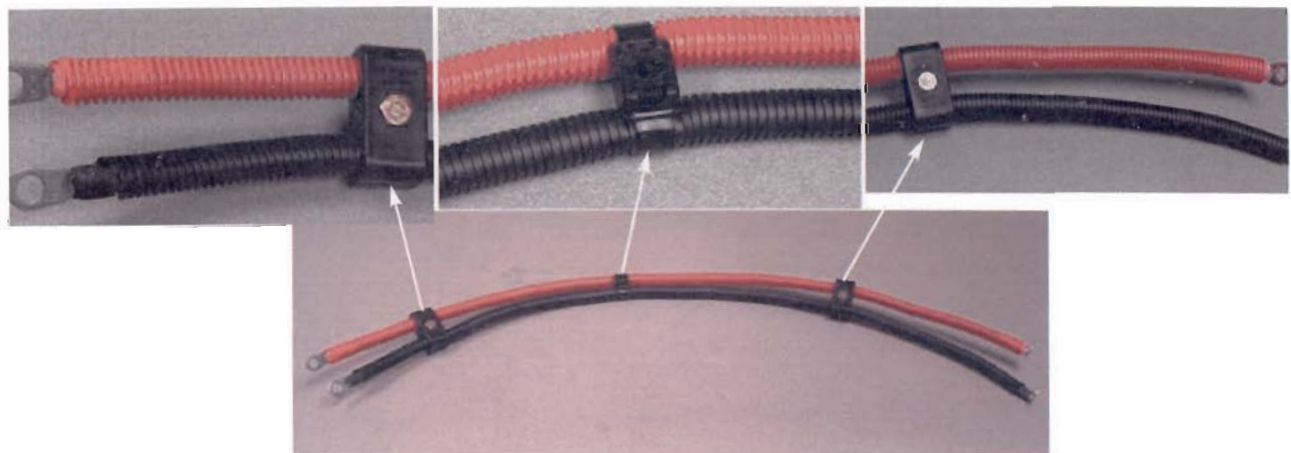


Figure 13

10. Install Flexible Trim Edging, TBB 65004144 around cable pass-thru cut-out in panel. **Figure 14**
11. Route cables from PDM (**Figure 15**), to the floor pass-thru (**Figure 16**). Attach upper/rear Dual Cable Clamp TBB 61371384 to the L-Bracket (**Figure 17**), and the front lower Dual Cable Clamp TBB 61371384 to the support bracket (**Figure 18**). Insure that the cable assembly has sufficient clearance between bus body structures.

Flexible Trim Edging,  
#TBB 65004144



Figure 14

Power Distribution  
Module (PDM)

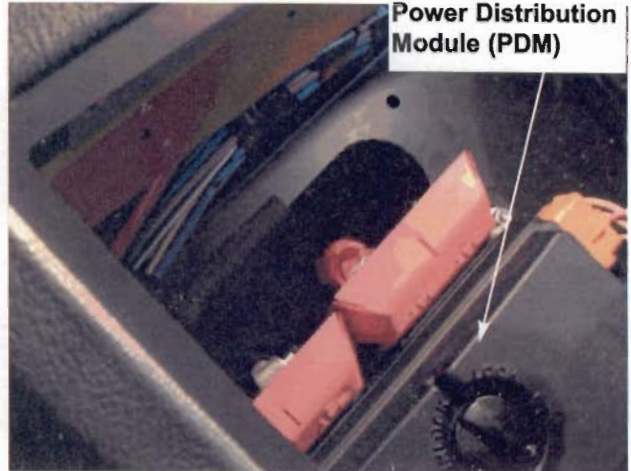


Figure 15

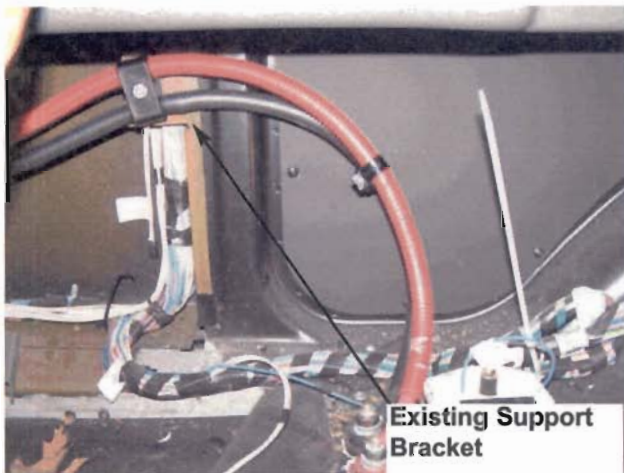


Figure 16

Existing Support  
Bracket

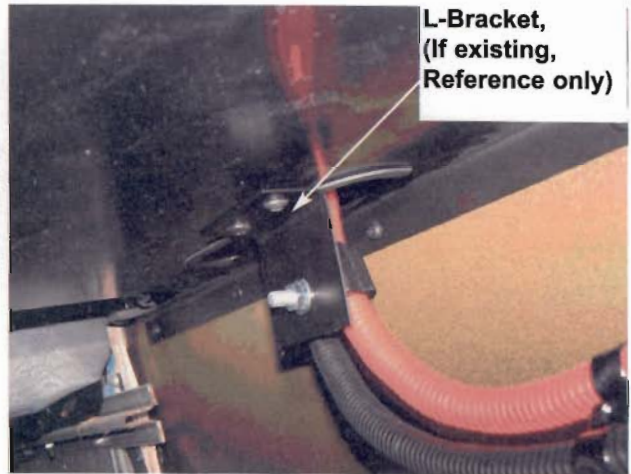


Figure 17

L-Bracket,  
(If existing,  
Reference only)

Fasteners-  
Hex Head Nut, TBB 61370842,  
Hex Head Bolt, TBB 61370815,  
Flatwasher, TBB 61370347

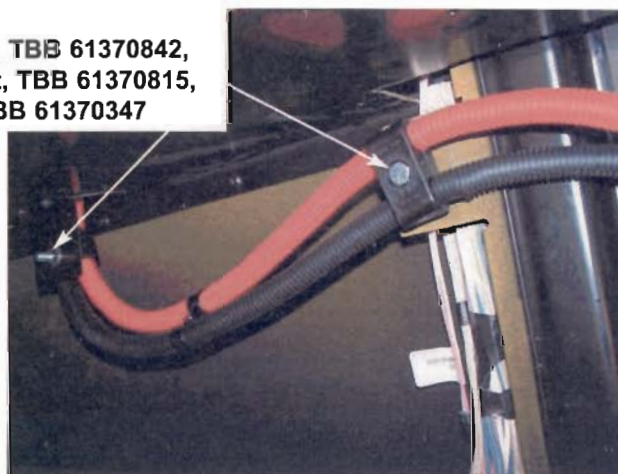


Figure 18

12. Reinstall trim, kick panels, rubber SHM/PDM cover, and switch assembly.
13. Reconnect the batteries and perform an electrical functional test.

**MATERIALS REQUIRED:**

<b><u>PART NUMBER</u></b>	<b><u>QTY.</u></b>	<b><u>DESCRIPTION</u></b>
TBB 61371384	2	DUAL CABLE CLAMP
TBB 61371394	1	DUAL TIE WRAP W/SPACE
TBB 61202027	A/R	TUBING 1/2" CONVOLUTED NYLON, BLACK
TBB 61201964	A/R	TUBING 1/2" CONVOLUTED NYLON, RED
TBB 65004144	A/R	TRIM-FLEXIBLE EDGING
TBB 105408	*1	MOUNTING L-BRACKET, SWITCH CABINET (*ORDER ONLY IF NOT INSTALLED ON UNIT)
TBB 61370815	2	BOLT, HEX HEAD, 5/16-18 X 1-1/2 INCH
TBB 61370347	2	FLATWASHER, 5/16
TBB 61370842	4	NUT, HEX HEAD, SERRATED FLANGE, 5/16-18

**WARRANTY STATUS:**

WITHIN PROVISIONS OF TBB WARRANTY

**ELECTRONIC WARRANTY CODE: 7556**

**SRT CODE: 52-36, TIME ALLOWANCE - 0.8 HR.**

**QC: X10**