

SERVICE PROCEDURE

G-06502
May 2006

**SUBJECT: SAFETY RECALL (U.S., EXPORT)
ENGINE OIL SAMPLING VALVE on certain 9400i
Models built 4/27/2005 thru 1/23/2006 with Feature
Code 12WEE**

DEFECT DESCRIPTION

The hose connecting the engine block to the frame mounted oil sampling valve is routed too close to the engine's turbocharger. Heat from the turbocharger may cause the hose to melt. If melting of the hose occurs, engine oil could be sprayed upward onto the surface of the turbocharger housing possibly causing smoke or a **fire**. This may lead to **property damage, personal injury or death**.

MODELS INVOLVED

This Safety Recall involves 9400i models built between 4/27/2005 and 1/23/2006 with feature code 12WEE - *ENGINE OIL SAMPLE VALVE Mounted on the Right Rail in the Front Wheel Well.*

PARTS INFORMATION

The parts required for this recall are:

Part Number	Part Description	Quantity
8900184R91	KIT, VALVE OIL SAMPLING RECALL	1

SERVICE PROCEDURE



WARNING:

TO PREVENT SERIOUS EYE INJURY, ALWAYS WEAR SAFE EYE PROTECTION WHEN YOU PERFORM VEHICLE MAINTENANCE OR SERVICE.



WARNING:

TO PREVENT UNEXPECTED MOVEMENT OF THE VEHICLE AND POSSIBLE SERIOUS PERSONAL INJURY OR DEATH, BLOCK THE WHEELS TO PREVENT THE VEHICLE FROM MOVING IN BOTH DIRECTIONS.

1. Locate the engine oil sampling valve system on the passenger side of vehicle, under turbo.

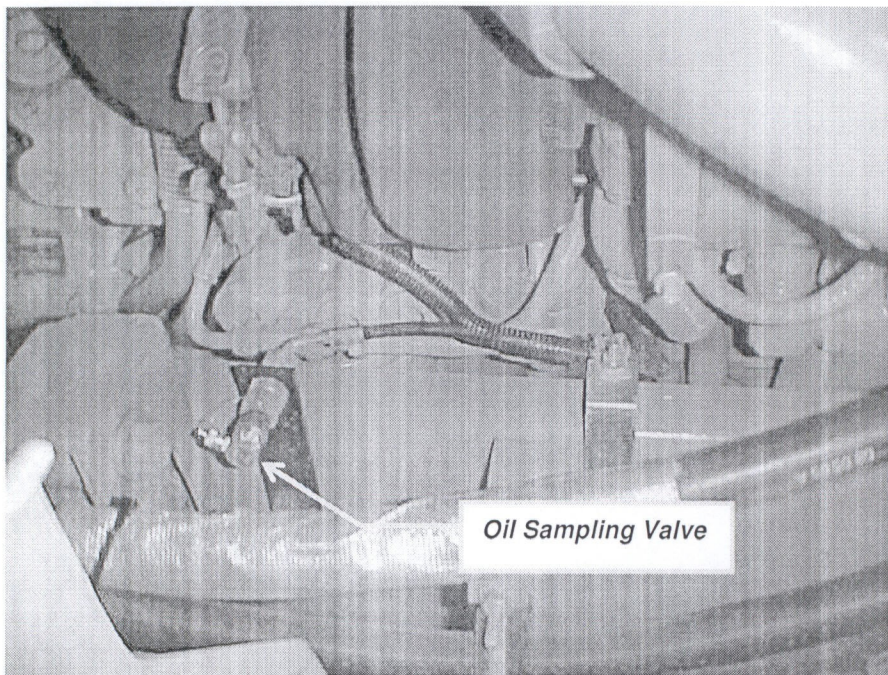

Figure 1 – CAT engine shown, Cummins Same location, however see Figure 1a

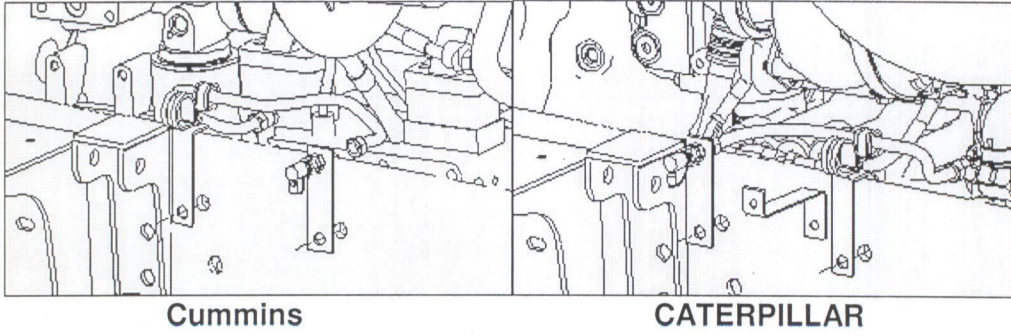

Figure 1a

2. Ensure engine is off and temperature of engine block and turbocharger housing area is cool enough to be safely touched before continuing with this service procedure.



WARNING:

TO AVOID PERSONAL INJURY OR DEATH ALLOW THE ENGINE TO COOL SUFFICIENTLY BEFORE PERFORMING THE REMAINDER OF THIS PROCEDURE.

3. The majority of hoses requiring replacement in this campaign will not have a reflective wrap, however the following vehicles have had a reflective wrap installed at the factory which **STILL REQUIRE THE SERVICE PROCEDURE TO BE PERFORMED.**

VIN
6C354482
6C354483
6C354484
6C354485
6C354486
6C354487

Table 1

4. Remove p-clip. Save hardware and p-clip for re-use.

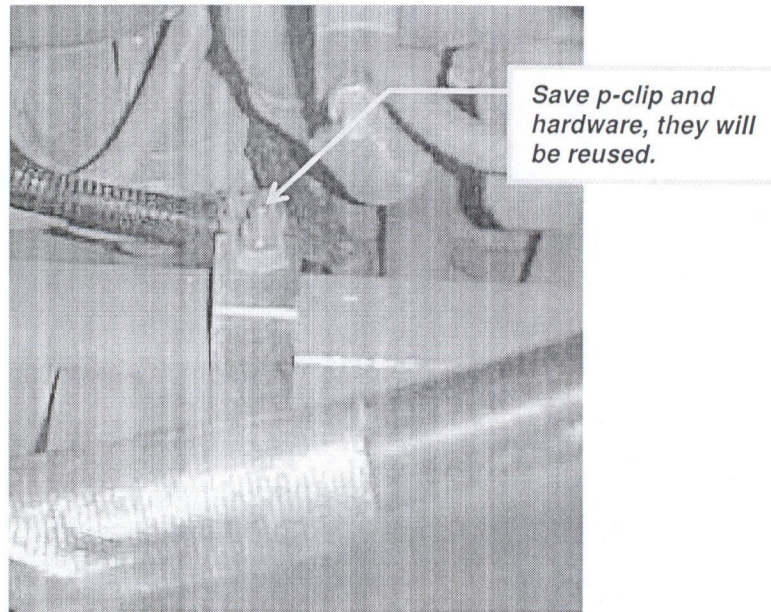

Figure 2 – CAT Engine Shown

5. Remove convoluted tubing and/or reflective heat wrap from hose.

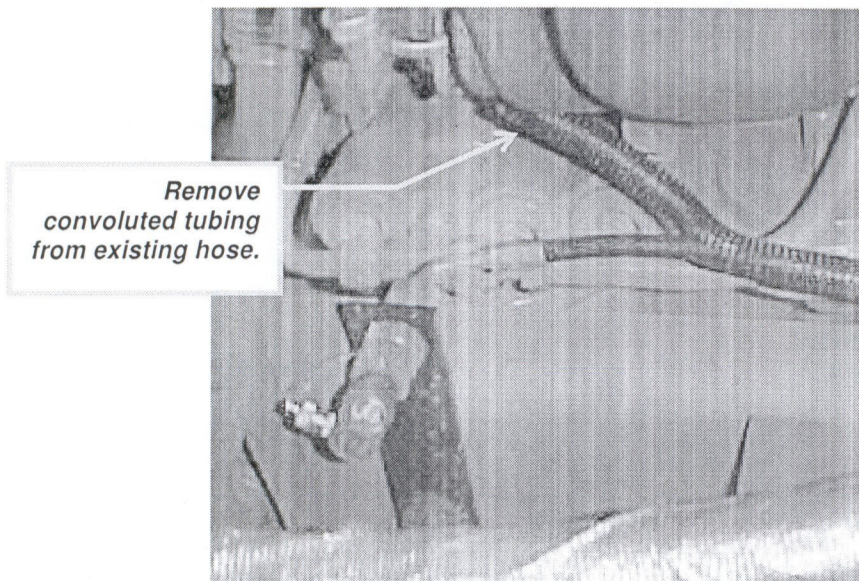

Figure 3 – Example CAT Engine with only convoluted tubing shown.

6. Loosen and remove hose from engine block. Be careful to leave engine block fitting in place.

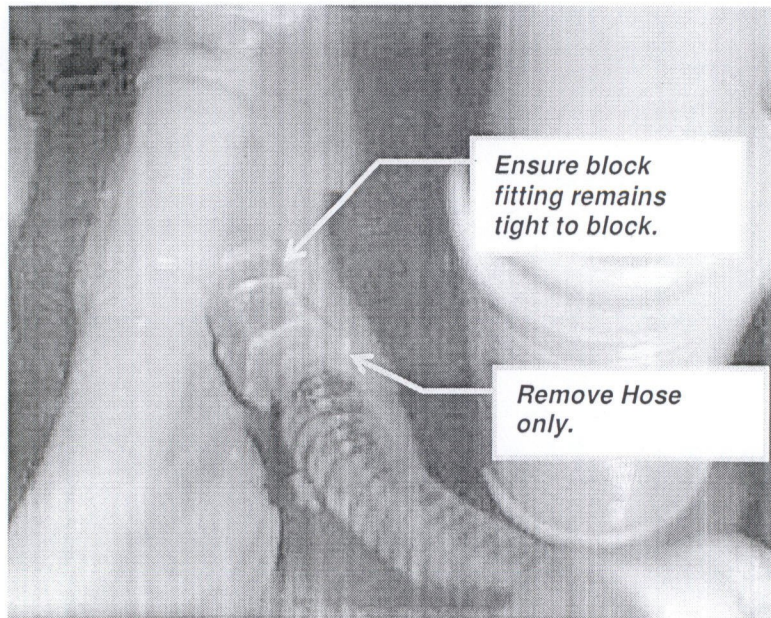

Figure 4 – CAT Engine Shown

NOTE: *SOME ENGINE OIL MAY DRIP FROM EXPOSED FITTING. Keep area clean to prevent debris from entering exposed fittings.*

7. Loosen and remove hose assembly from sampling valve. Discard removed hose assembly.

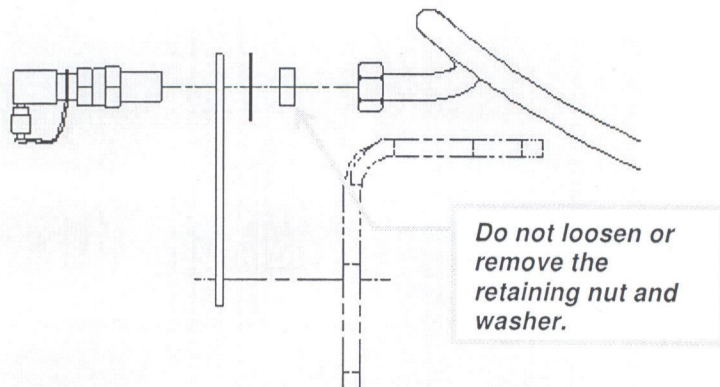

Figure 5

8. Install new hose assembly onto engine block.

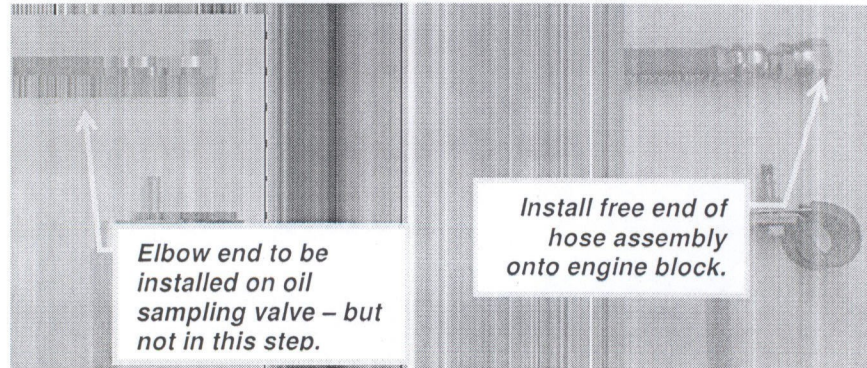

Figure 6

NOTE: 90° elbow is to be located at oil sampling valve. Free end of new hose assembly is to be installed at the engine block.

9. Install reflective heat wrap over hose *before* installing 90° onto oil sampling valve.
10. Install 90° fitting onto oil sampling valve.

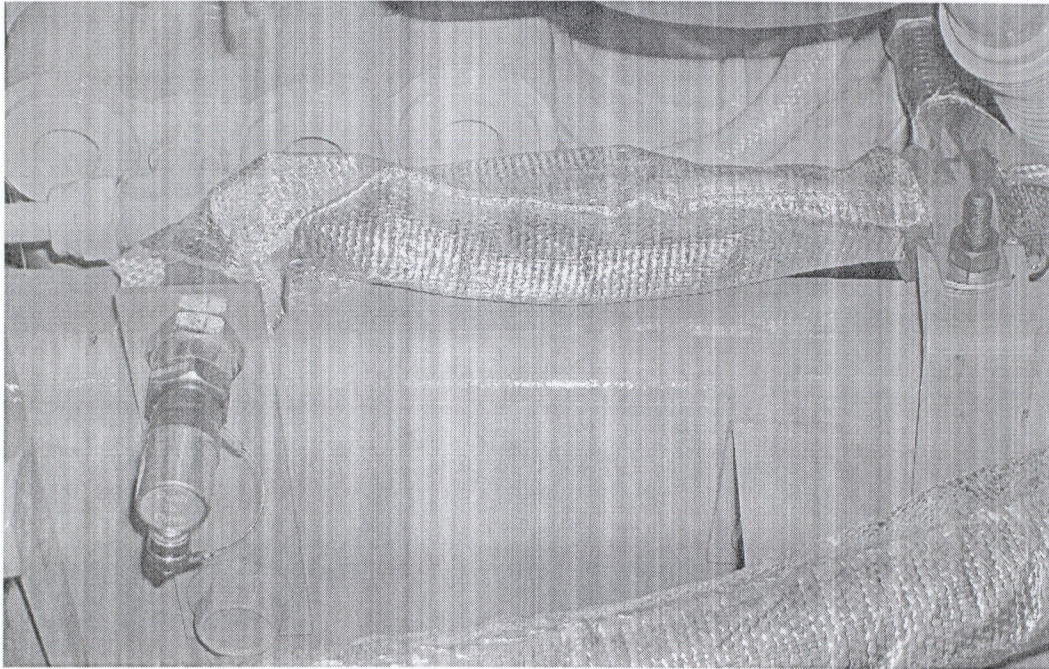

Figure 7 – CAT Engine Shown. For CUMMINS engines, orient as per Figure 1a

11. Re-install p-clip on support extension *over* heat wrap.

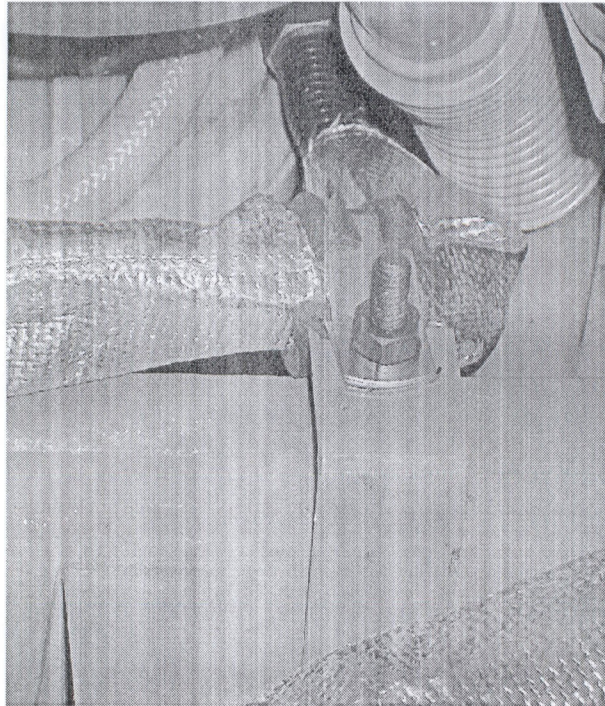

Figure 8

12. Start engine to check for leaks, tighten/repair as necessary, check engine oil level and add as necessary.

END OF SERVICE PROCEDURE

LABOR INFORMATION

<u>Operation No.</u>	<u>Description</u>	<u>Time</u>
A40-06502-1	<i>PERFORM RECALL SERVICE PROCEDURE</i>	0.9 hr

CAMPAIGN IDENTIFICATION LABEL

*Each vehicle corrected in accordance with this campaign **must be** marked with a CTS-1075 Campaign Identification Label.*

Complete the label and attach on a clean surface next to the vehicle identification number (VIN) plate.



The image shows a rectangular label with a black border. At the top and bottom, it says "DO NOT REMOVE" in white capital letters. Inside the border, the word "INTERNATIONAL" is printed in bold. Below that, there are four fields: "Campaign No.", "VIN", "Eng.#", and "Service Location Code #". The word "COMPLETED" is printed in the center of the label.

ADMINISTRATIVE/DEALER RESPONSIBILITIES (U.S. & POSSESSIONS)

Proceed immediately to make necessary correction to units in inventory. **All inventory vehicles subject to this recall campaign must be corrected prior to sale, transfer or delivery.** If vehicles have been sold or transferred and you are in receipt of Customer Notification Letters and Authorization for Recall Service cards for those vehicles, the transfer location or customer must be notified **IMMEDIATELY** from your dealer location.

Dealers must correct all vehicles subject to this campaign at no charge to the owner, regardless of mileage, age of vehicle, or ownership, from this time forward.

The National Traffic and Motor Vehicle Safety Act, as amended, provides that each vehicle that is subject to a vehicle recall campaign must be adequately **repaired** within a reasonable time after the owner has tendered it for repair. A failure to adequately repair within **60 days** after a tender of a vehicle is prima facie evidence of failure to repair within a reasonable time. If the condition is not adequately repaired within 60 days, the owner may be entitled to **replacement** with an identical or reasonable equivalent vehicle at no charge, or to a **refund** of the purchase price less a reasonable allowance for depreciation.

However, consistent with the customer notification, dealers are expected to complete the repairs on the mutually agreed upon service date.

To avoid having to replace an owner vehicle or refund the purchase price, every effort must be made to promptly schedule an appointment with each owner to repair his or her vehicle as soon as possible.

During the recall process, a listing of owner names and addresses will be furnished to the involved dealers to enable dealers to follow up with owners and have the vehicles corrected. You must limit the use of this listing to this campaign because the list may contain information obtained from state motor vehicle registration records and the use of such motor vehicle registration data for purposes other than this campaign is a violation of law in several states.

WARRANTY CLAIMS

Refer to Dealer Warranty Manual for procedures to conduct Recall Campaigns.

It is important that the Recall Coding be completed properly to assist in processing the warranty claim. Complete instructions will be found in the Warranty Manual, Section 7-1. Special attention should be given to Items 39 through 44:

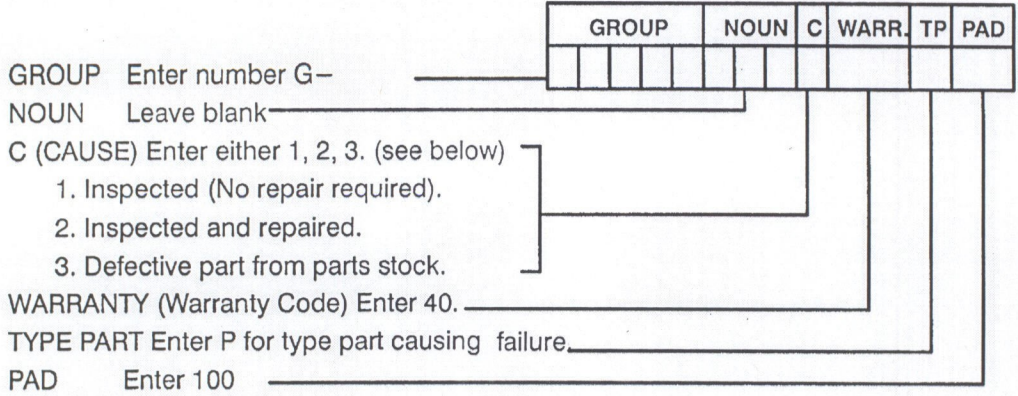

ADMINISTRATIVE/DISTRIBUTOR RESPONSIBILITY (EXPORT)

Proceed immediately to make necessary correction to units in inventory. All inventory vehicles subject to this recall campaign must be corrected prior to sale, transfer or delivery. If vehicles have been sold or transferred and you are in receipt of Customer Notification Letters and Authorization for Recall Service cards for those vehicles, the transfer location or customer must be notified from your distributor location.

Export locations are to submit warranty claims in the usual manner making reference to this recall number.

We ask for your full cooperation and follow-up to this important subject matter. If you have any questions or need further assistance, please contact the Regional Service Manager at your regional office.

INTERNATIONAL TRUCK AND ENGINE CORPORATION