

# NISSAN

-----  
**NISSAN NORTH AMERICA, INC.**

Corporate Office  
18501 South Figueroa St.  
Gardena, California 90248-4500  
Mailing Address: P.O. Box 191  
Gardena, California 90248-0191  
Telephone: 310.532.3111

APR 10 2006 10:54  
TECHNICAL COMPLIANCE

April 6, 2006

Mr. George Person  
Chief, Recall Analysis Division  
Office of Defects Investigation  
Safety Assurance  
National Highway Traffic Safety Administration  
400 Seventh Street, S.W.  
Washington, D.C. 20590

Ref: 05V-555

Dear Mr. Person:

The enclosed communication is being provided pursuant to 49 CFR Part 573.6(c)(9).

Technical Compliance Department

Encl.

To: ALL NISSAN DEALER PRINCIPALS, SERVICE MANAGERS, AND PARTS MANAGERS

Subject: 2003-04 350Z Fuel Hose Voluntary Safety Recall Campaign Update #3

Attention – Dealer Principals, Parts and Service Managers

The following is an update to previously communicated information regarding this campaign.

\*\*\*\*\* Revised Repair Instructions \*\*\*\*\*

Recall Campaign Bulletin NTB06-014 has been revised to include additional repair procedures for this campaign. Specifically, the revised bulletin includes an expanded re-assembly procedure.

Recall Campaign Bulletin NTB06-014A is now available on ASIST and on NNA.net under My Documents in the Parts/Campaigns and Service/Campaigns categories.

Note: Please discard any paper copies of NTB06-014 which were previously issued for this campaign.

If you have any additional questions related to this campaign, please contact your Dealer Parts and Service Manager (DPSM).

Nissan Parts and Service Operations  
04/04/2006



# RECALL CAMPAIGN BULLETIN

Reference:

NTB06-014a

Date:

April 4, 2006

## VOLUNTARY RECALL CAMPAIGN FUEL HOSES

This bulletin has been amended. The Re-Assembly procedure has been expanded. Please discard all previous versions of this bulletin.

**CAMPAIGN I.D. # / NHTSA #:** R0505 / 05V-555

**APPLIED VEHICLES:** 2003-04 350Z (Z33)

**APPLIED VINS:** 2003 MY 350Z: JN1AZ3\*\*\*3T000001 - 120447

2004 MY 350Z: JN1AZ3\*\*\*4T000001 - 160537

**NOTE: Use Service Comm to confirm campaign eligibility.**

### INTRODUCTION

Nissan has determined that some 2003 - 2004 model year Nissan 350Z vehicles may have a defect which relates to motor vehicle safety. There is the possibility that the fuel filler hose may crack and result in fuel leakage from the hose while refueling. If an ignition source is present, a fire could occur. In addition, fuel vapor hoses may crack and cause the malfunction indicator lamp to come on. To prevent this condition from occurring, Nissan is conducting a Voluntary Safety Recall Campaign to replace the fuel filler and vapor hoses with new ones.

### IDENTIFICATION NUMBER

Nissan has assigned identification number R0505 to this campaign. This number must appear on all communications and documentation of any nature dealing with this campaign.

### NUMBER OF VEHICLES POTENTIALLY AFFECTED

The number of vehicles potentially affected is approximately 52,400.

### DEALER RESPONSIBILITY

It is the retailer's responsibility to check Service Comm for the campaign status on each vehicle falling within the range of this voluntary safety recall which for any reason enters the service department. This includes vehicles purchased from private parties or presented by transient (tourist) owners and vehicles in a dealer's inventory. **Federal law requires that new vehicles in dealer inventory which are the subject of a safety recall must be corrected prior to delivery under a sale or lease. Failure to do so can result in civil penalties by the National Highway Traffic Safety Administration.** While federal law applies only to new vehicles, Nissan strongly encourages dealers to correct any used vehicles in their inventory before they are retailed.

## Repair Overview

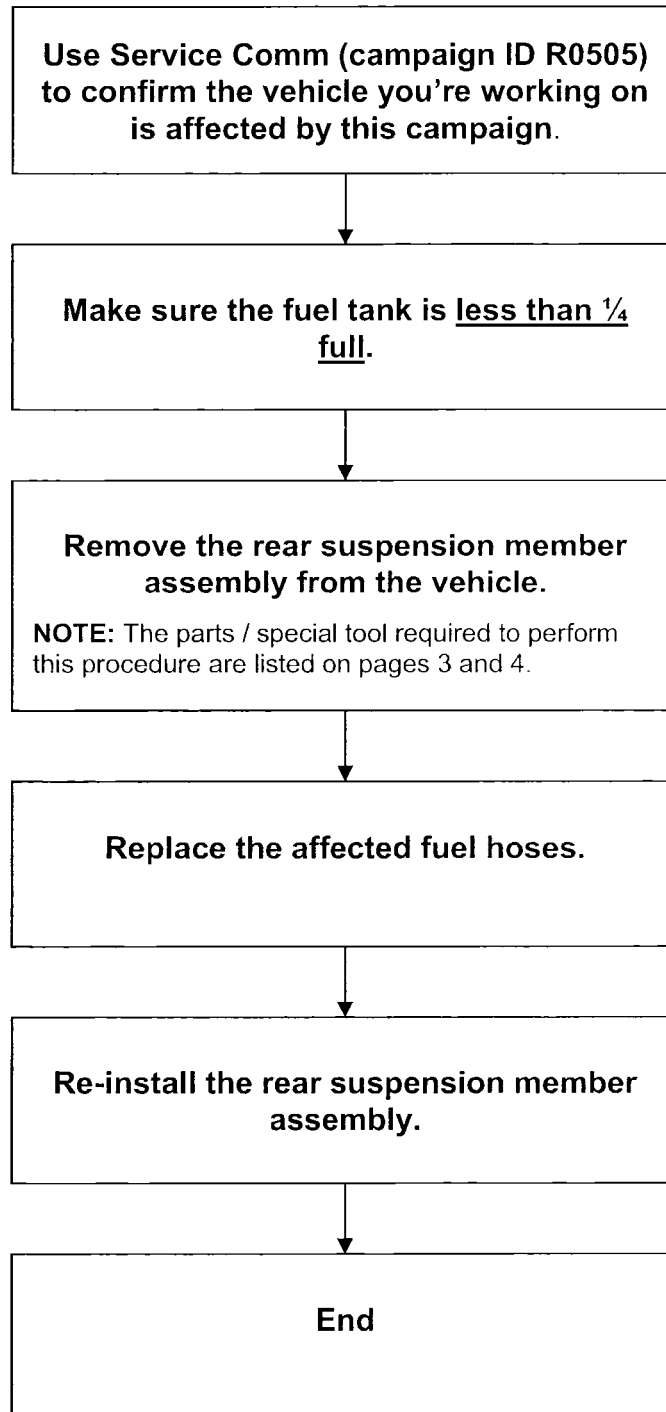

## REQUIRED PARTS

Remove the rear suspension member assembly and replace four fuel hoses (from the kit) as follows.

To perform this procedure, you will need the items listed below. Refer to the Parts Information section for the part numbers.

- Fuel hose kit (see Figure 1a)

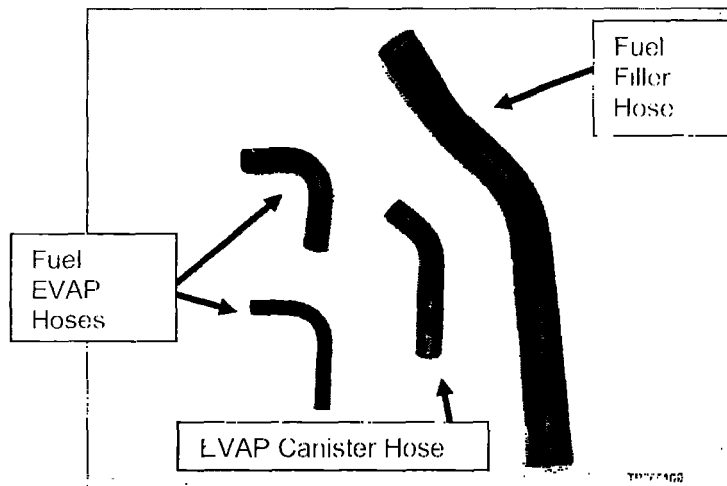

Figure 1a

- Propeller shaft bolt kit (see Figure 1b)



Figure 1b

- Exhaust tube gasket (see Figure 1c)

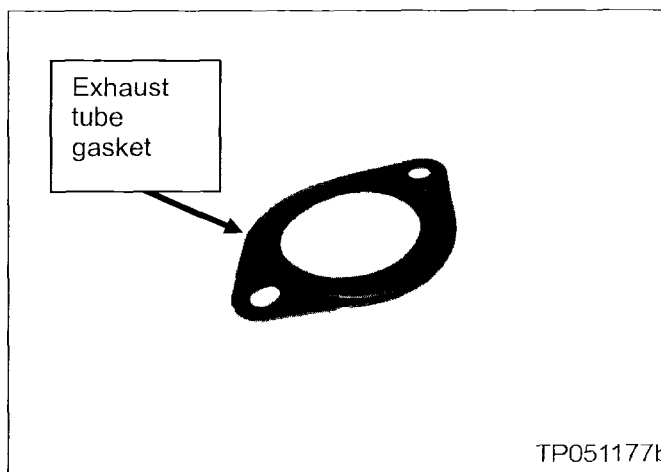

Figure 1c

TP051177b

## REQUIRED SPECIAL TOOL (sent to each dealer)

The essential Jack Adapter Tool J-47441 will be needed to perform this procedure.

- If you are using an OTC 16-1728 high lift transmission jack, use adapter block J-47002-4 between the jack and the jack adapter tool J-47441.
- The adapter block is part of essential tool J-47002 transmission jack adapter kit.

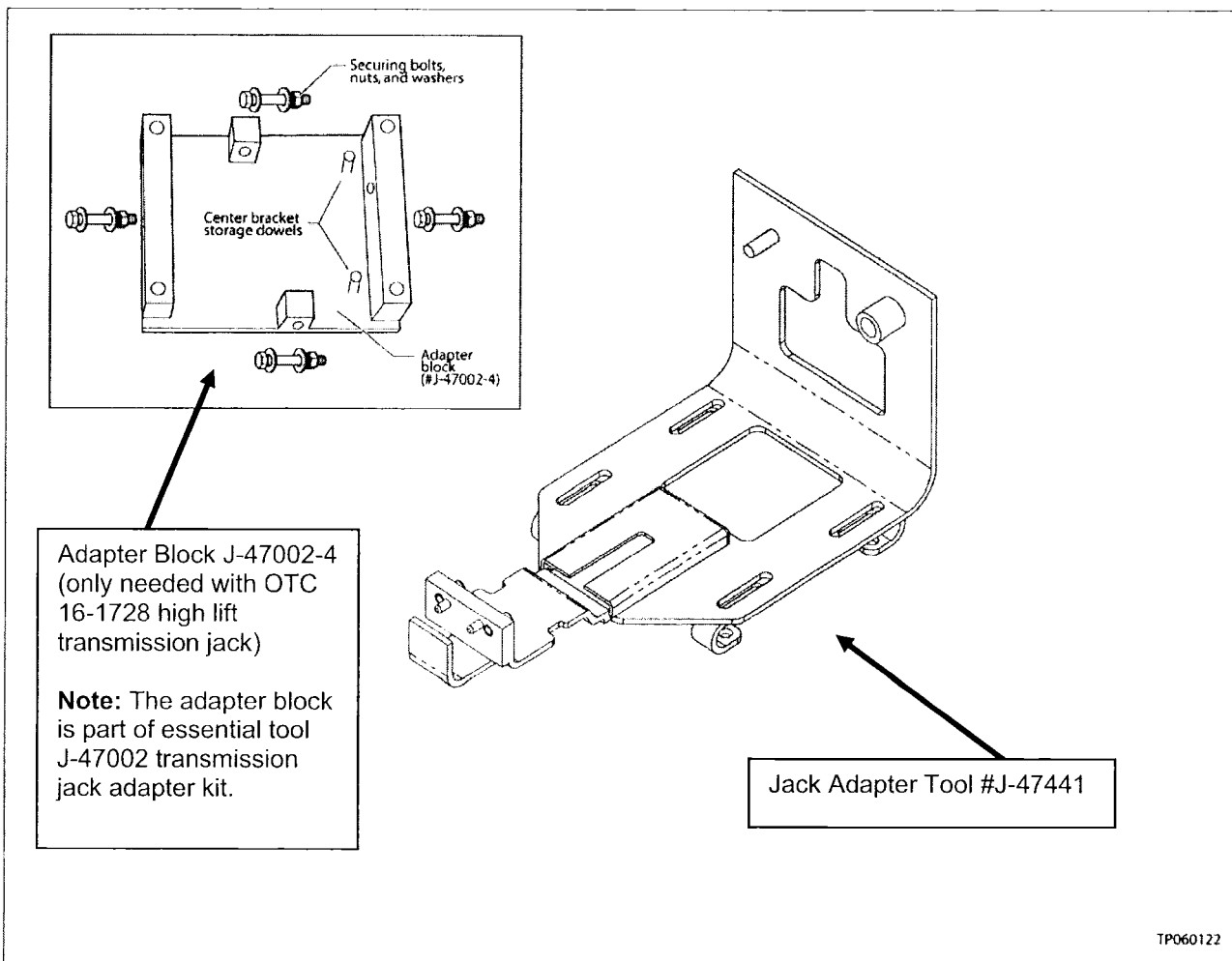

Figure 1d

**NOTE:** Replacement tools can be ordered from Nissan TECH-MATE at 1-800-662-2001.

## SERVICE PROCEDURE

### Preliminary Steps

1. Record all radio station presets.
2. Disconnect the negative battery cable.
3. Raise the vehicle on a hoist.

**NOTE:** Make sure you release the parking brake.

### Remove Rear Wheels/Brake Calipers

4. Remove both rear wheels/tires.
5. Remove both brake calipers and hang them from the brake line supports with wire (see Figure 2).

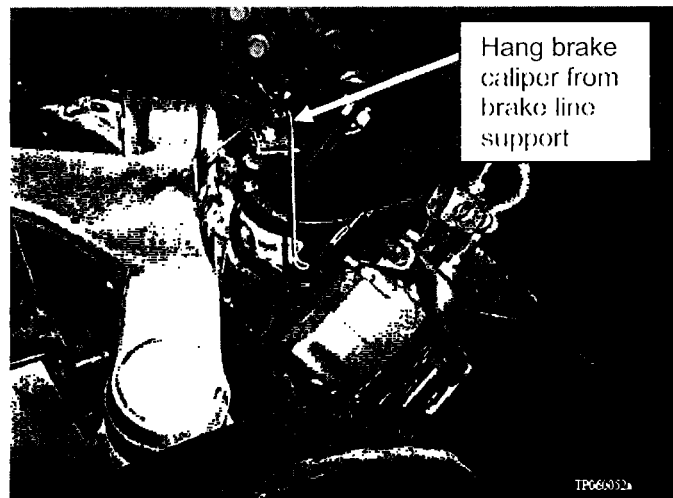

Figure 2

### Remove Center Exhaust Tube/Rear Muffler

6. Remove the exhaust system ground strap from the muffler stud/nut (see Figure 3).

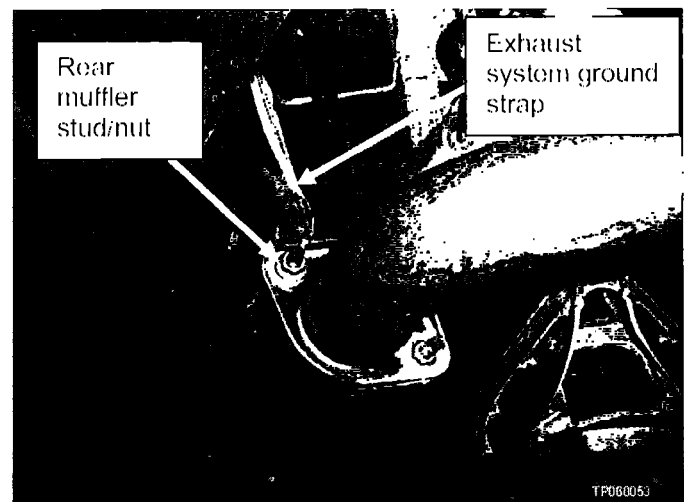

Figure 3

7. On the passenger (RH) side: remove two bolts and one clip and remove the rear plastic under cover (see Figure 4).

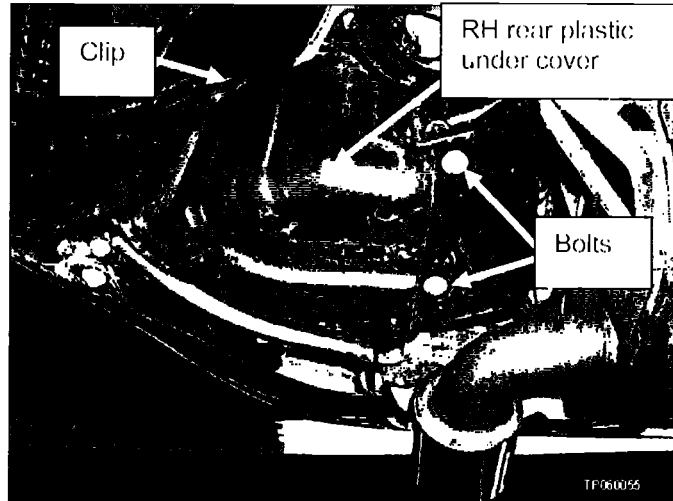

Figure 4

8. Below the plastic cover you just removed: remove three bolts and remove the rear metal cover (see Figure 5).

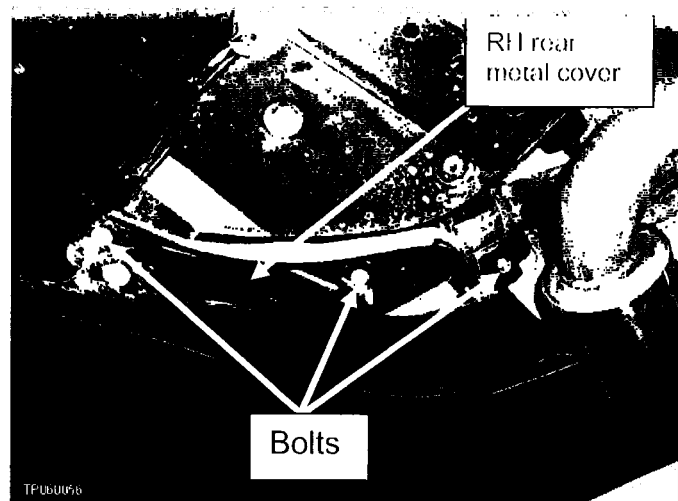

Figure 5



9. On the driver's (LH) side: remove two nuts and one clip and remove the rear plastic under cover (see Figure 6).

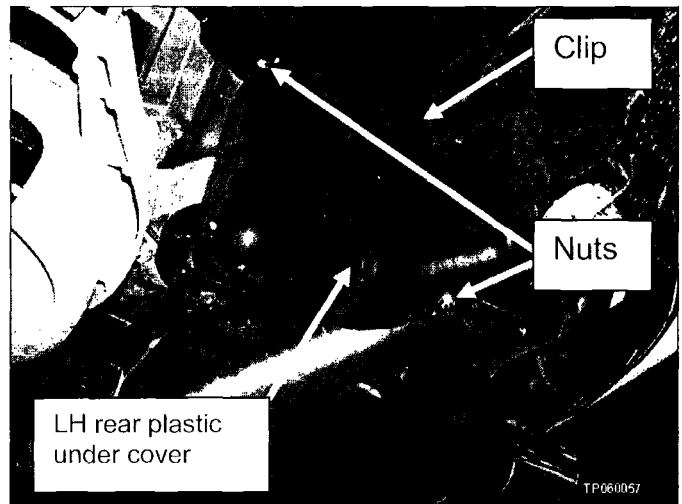

Figure 6

10. Below the plastic cover you just removed: remove two bolts and one clip and remove the rear metal cover (see Figure 7).

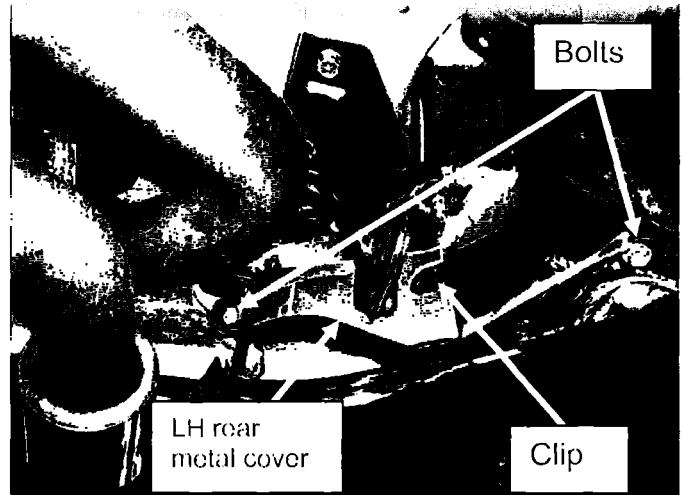

Figure 7

11. Remove nuts and bolts and remove the tunnel stay side covers and the tunnel “stay” bracket (see Figure 8).

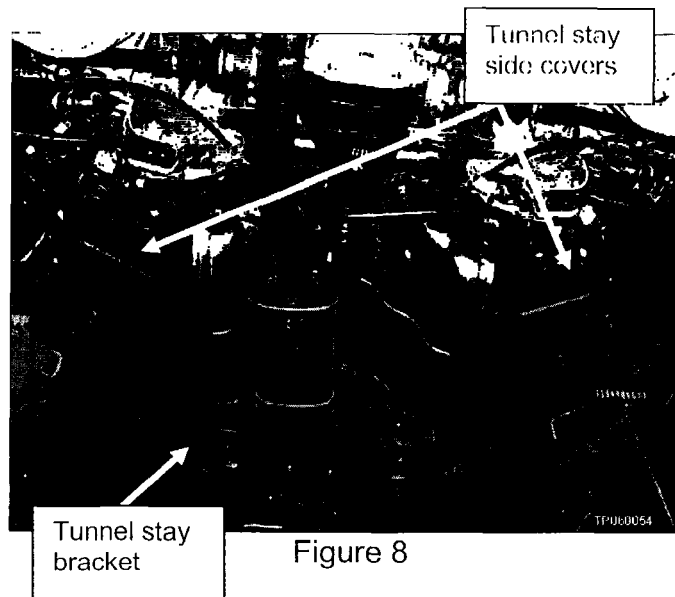

Figure 8

12. Remove the nut that holds the center muffler mount bracket (see Figure 9).

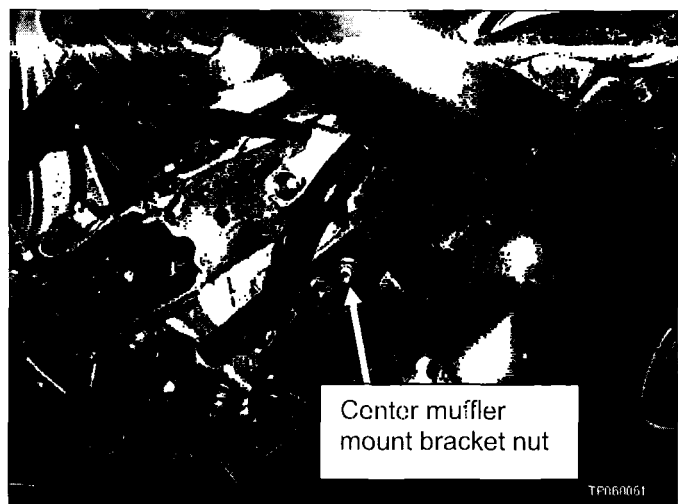

Figure 9

13. Remove the bolt that holds the passenger (RH) side rear muffler mount bracket (see Figure 10).

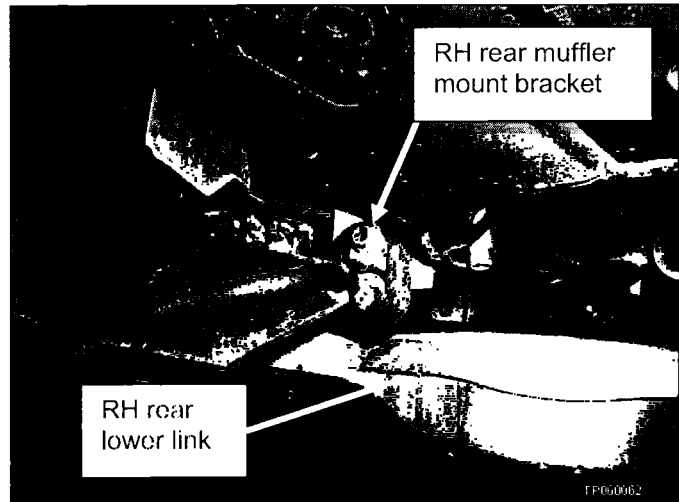

Figure 10

14. Remove the exhaust system center tube front nuts (see Figure 11).

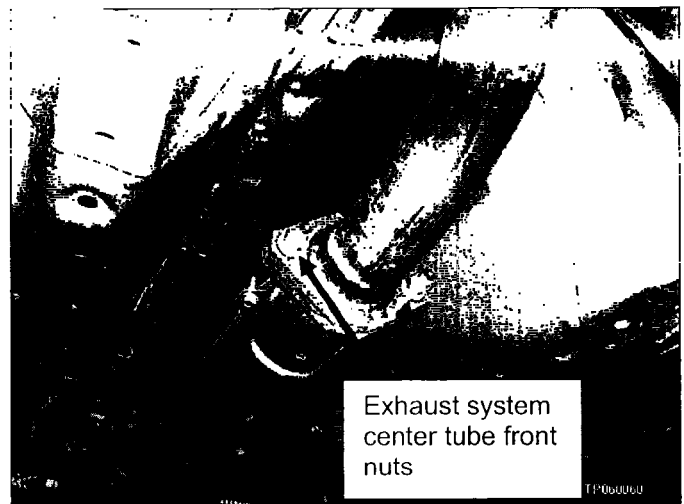

Figure 11

15. Support the rear muffler (see Figure 12).

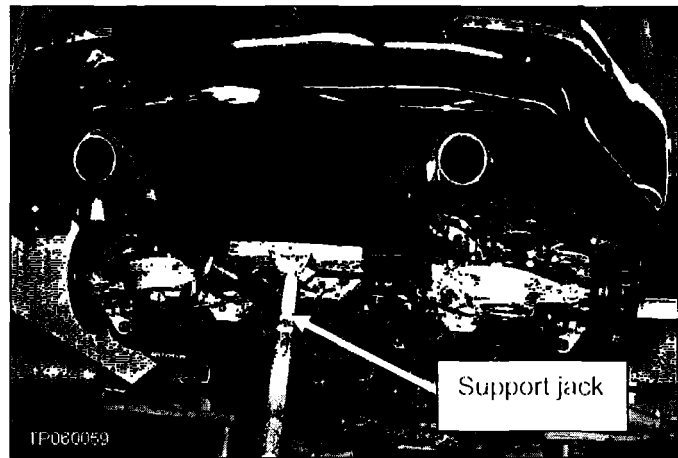

Figure 12

16. Remove the rear muffler bracket bolts (see Figure 13a and 13b).

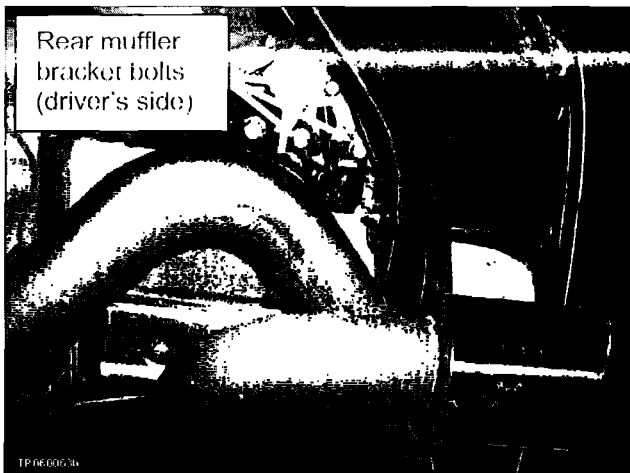

Figure 13a

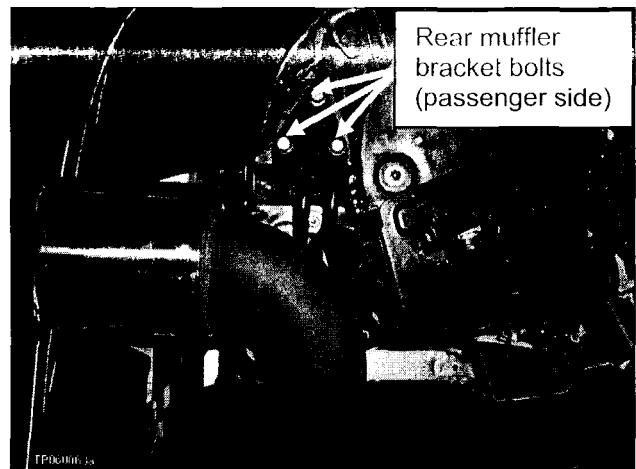

Figure 13b

17. Carefully remove the exhaust center tube/rear muffler and place it in a safe location (see Figure 14).

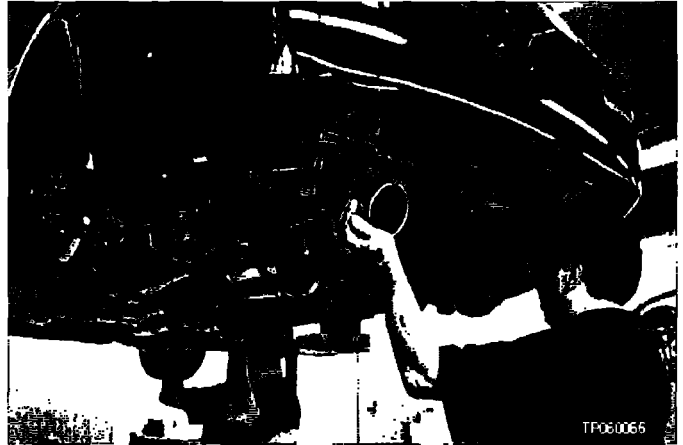

Figure 14

### Remove Propeller Shaft

18. Apply an “index” (line up) mark across the propeller shaft and differential pinion flange for correct re-assembly (see Figure 15).
19. Remove four nuts and bolts and **carefully** remove the propeller shaft and place it in a safe location.

**CAUTION: Avoid propeller shaft damage. Do NOT scratch, chip, ding, or dent the propeller shaft.**

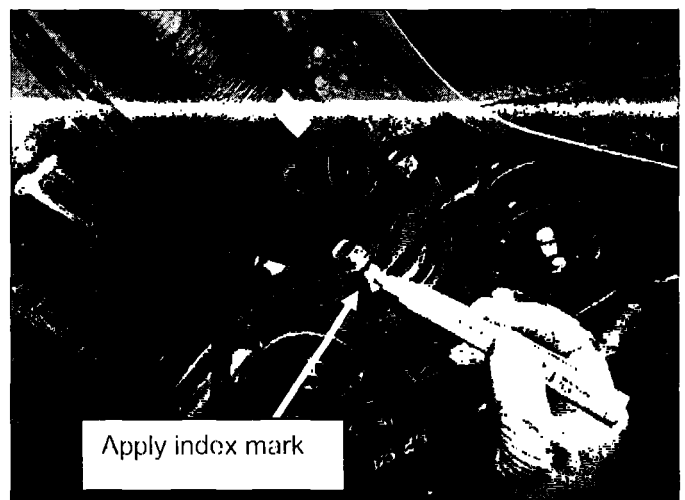

Figure 15

## Disconnect Parking Brake Cables

20. Disconnect the parking brake cables as follows:

- a. Remove the nuts that hold the parking brake cable brackets to the rear suspension member (see Figure 16).

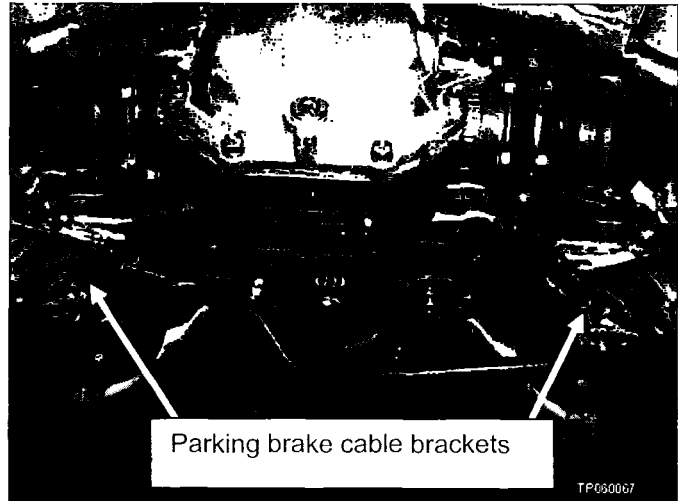

Figure 16

- b. Remove the cables from the metal support brackets (see Figure 17).



Figure 17

- c. Remove the nuts that hold the parking brake cables to the vehicle body (see Figure 18).
- d. Disconnect the cables from the front equalizer (see Figure 18).

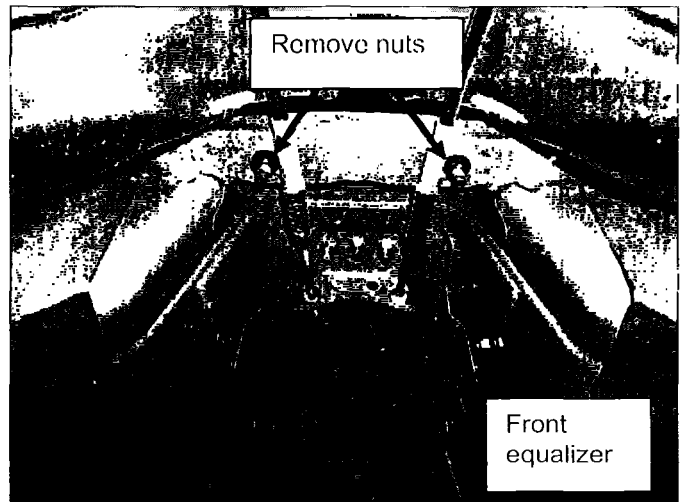

Figure 18

### Disconnect ABS Harness Connector/Remove Tie Wrap

21. Disconnect the ABS harness connector (see Figure 19a). Then remove the tie wrap from the suspension member using a pair of needle-nose pliers (see Figure 19b).

- If you accidentally break the tie wrap, install a new one at re-assembly. The tie wrap part number is 24225-89960.

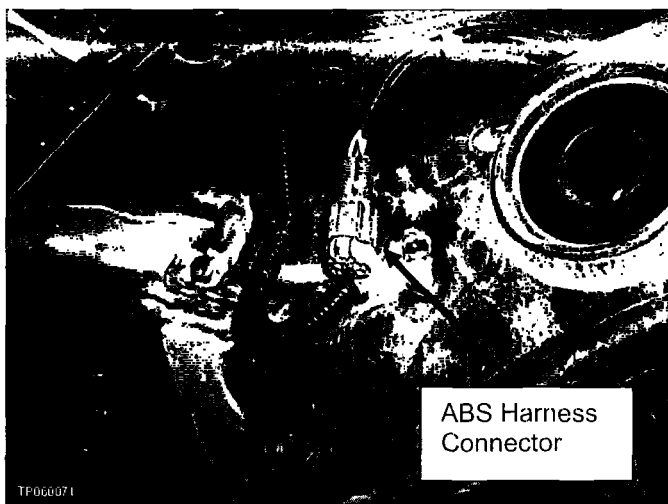

Figure 19a

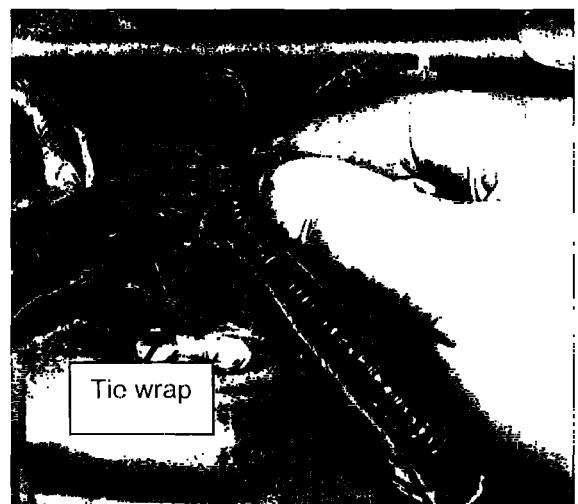

Figure 19b

## Disconnect Shock Absorber From Knuckle

22. Place a support jack under the rear lower link. Then remove the bolt that holds the shock absorber to the knuckle (see Figure 20).

**NOTE:** Do NOT disconnect the shock absorber from the body at the top of the wheel well.

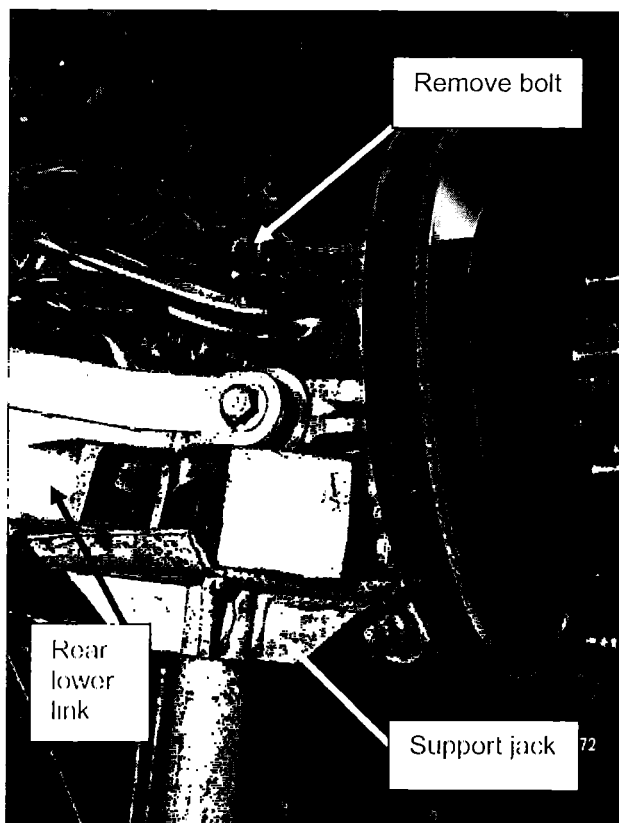

Figure 20

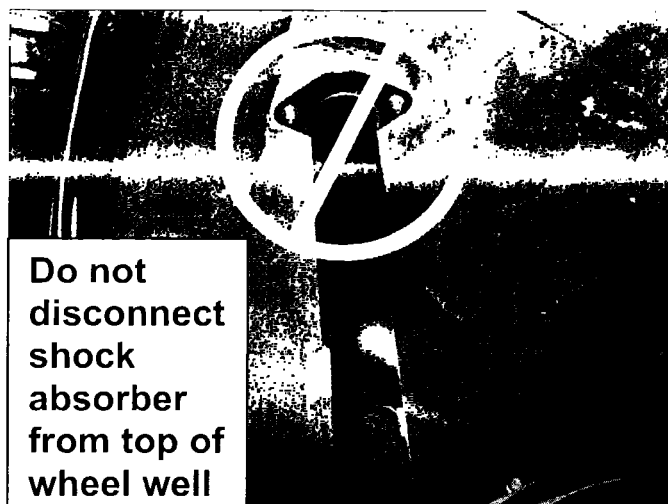

Figure 21



23. Place an index mark across the bushing and cross bar for proper re-assembly (see Figure 22).

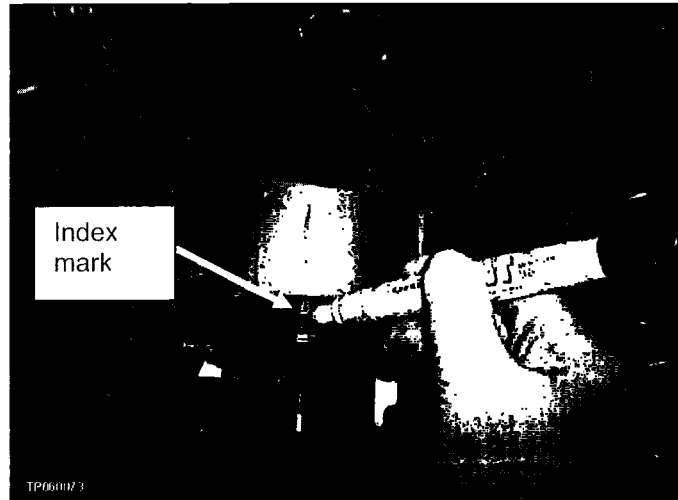

Figure 22

### Install Jack Adapter Tool #J-47441 To Differential

24. Install the jack adapter tool #J-47441 to the differential pinion flange and suspension member as follows:
- Install part "A" of the adapter tool onto the pinion flange. Make sure both pins on the tool are inserted into the pinion flange bolt holes (see Figure 23).

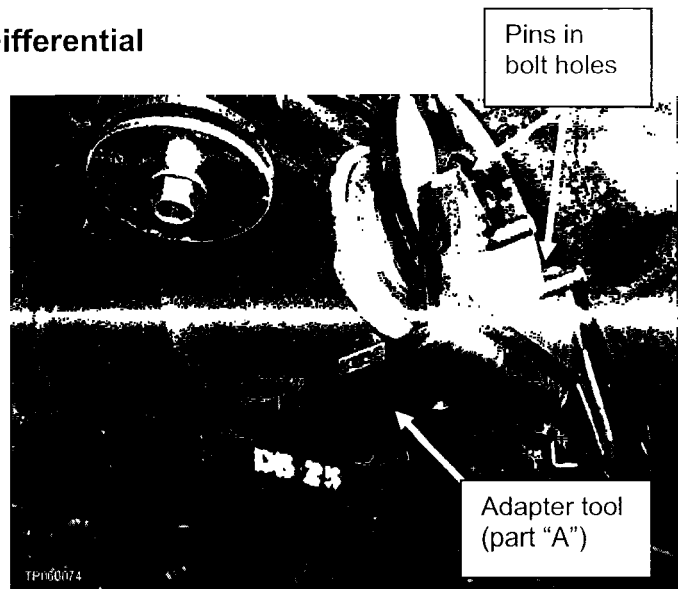

Figure 23

- b. Slide part "B" of the adapter tool over the rear of part "A". Then, insert the locator pins at the upper corners of the tool into the rear suspension member (see Figure 24).

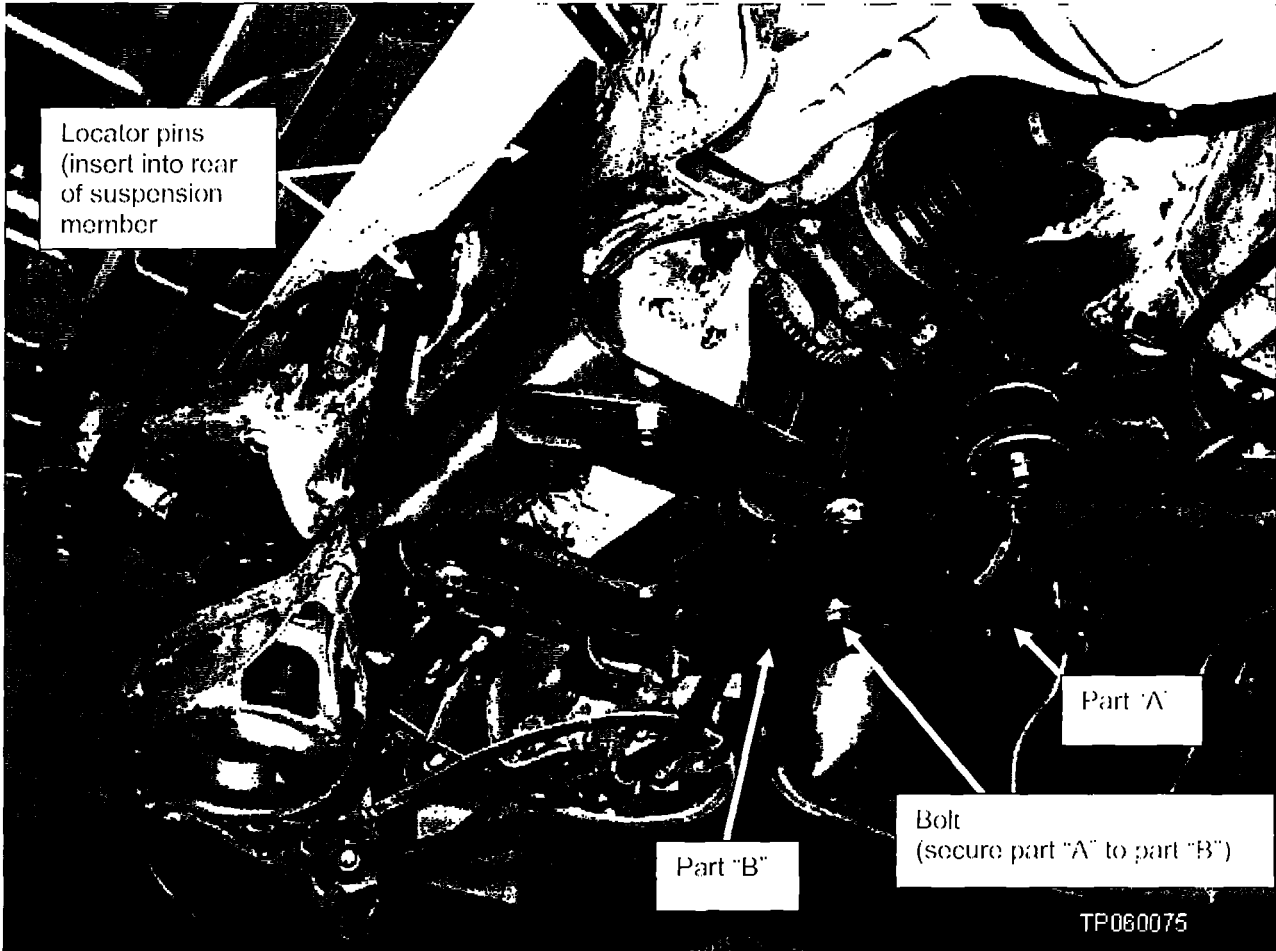

Figure 24

### Remove Rear Suspension Member

- 25. Use bolts to attach a transmission jack to the adapter tool (see Figure 25).



Figure 25

26. Place an additional support jack under the front suspension member to help stabilize the vehicle on the lift (see Figure 26).

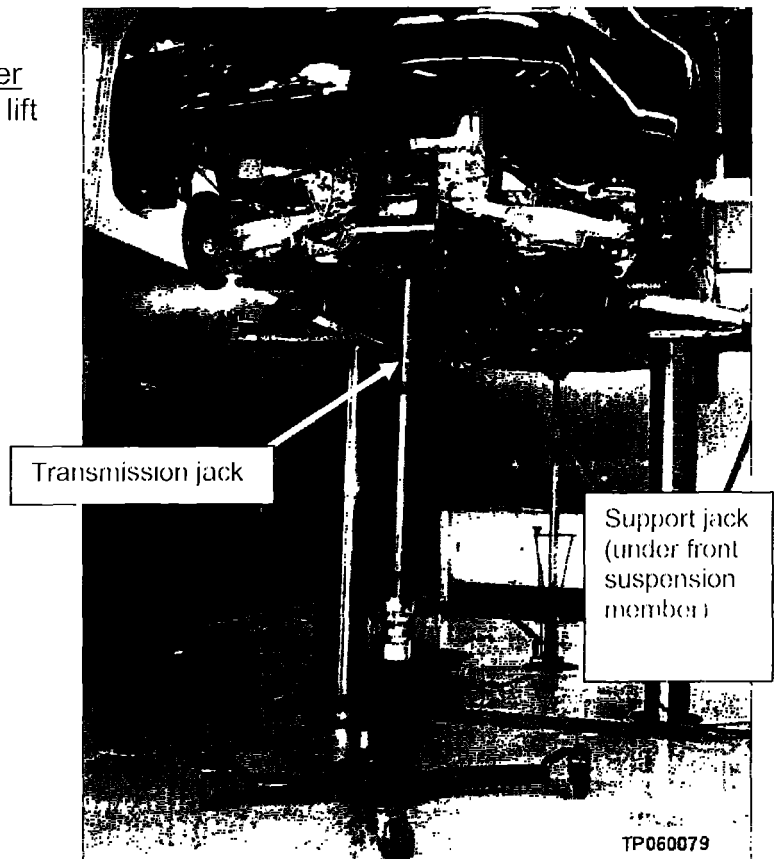

Figure 26

27. Place an index mark across the coil spring and upper spring seat for proper re-installation (see Figure 27).

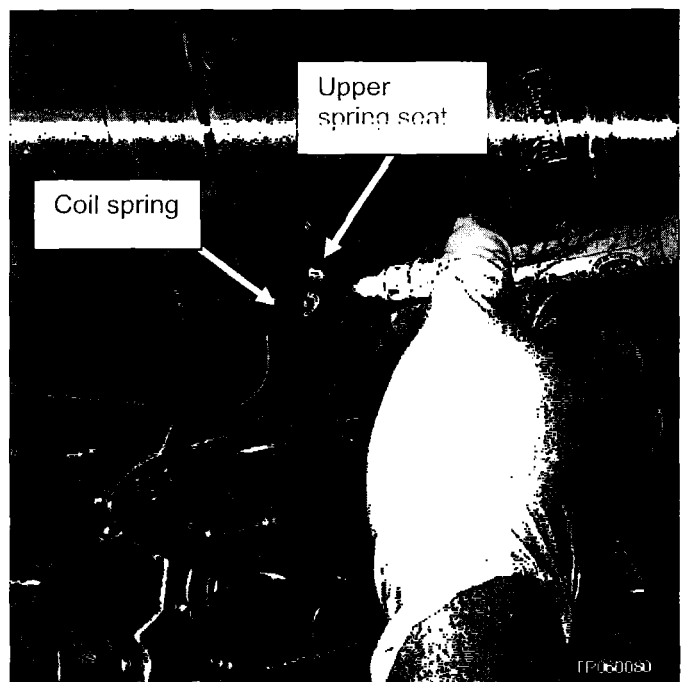
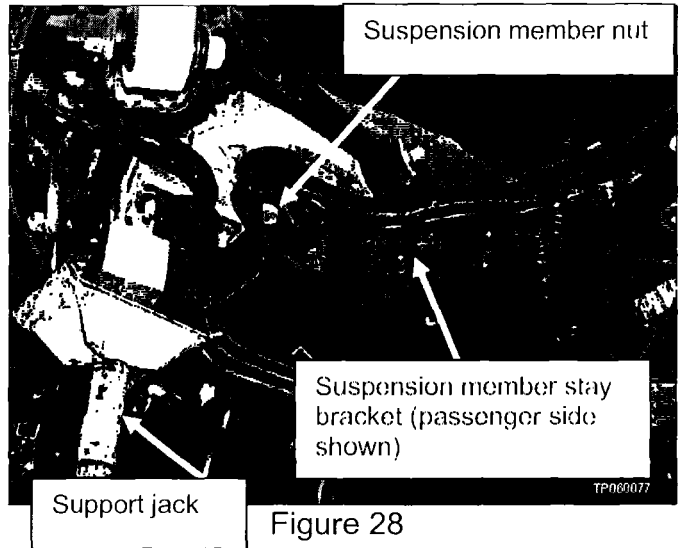

Figure 27

28. Place a support jack under the rear suspension member.

- Then remove the bolts and nuts that hold the suspension member “stay” brackets (both passenger and driver’s side brackets). See Figure 28.
- Slowly lower the support jack and remove the stay brackets.

**NOTE:** The larger nuts hold the suspension member.



29. Remove the bolts and nuts and remove the rear stay bracket (see Figure 29).



30. Carefully lower the suspension member (see Figure 30) and place it in a safe location away from "traffic".

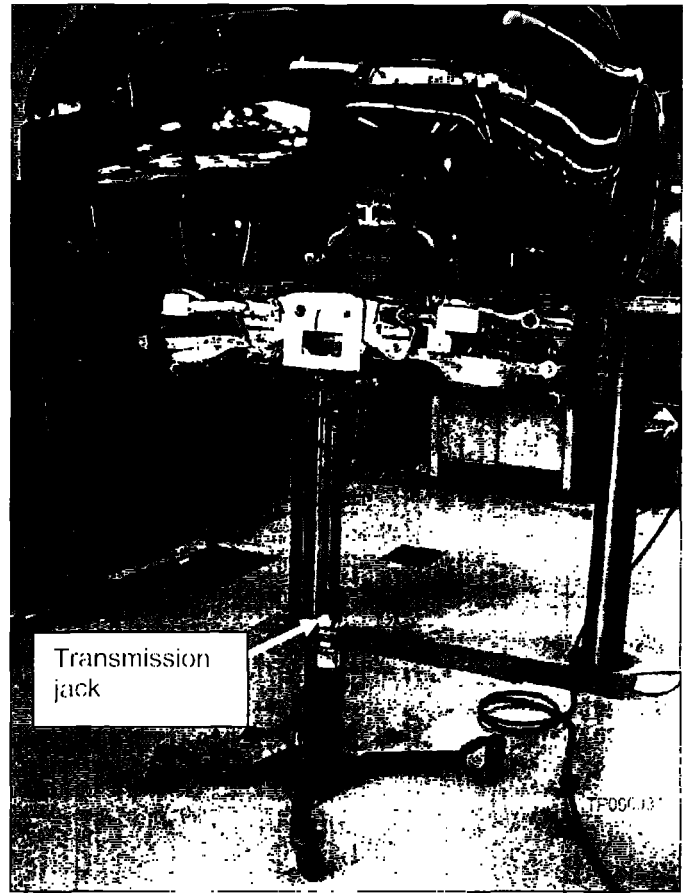

Figure 30

### Install Fuel Hoses

**CAUTION:** Make sure the fuel tank is less than 1/4 full before you perform this procedure.

31. Remove three nuts and remove the evaporative canister shield (see Figure 31).

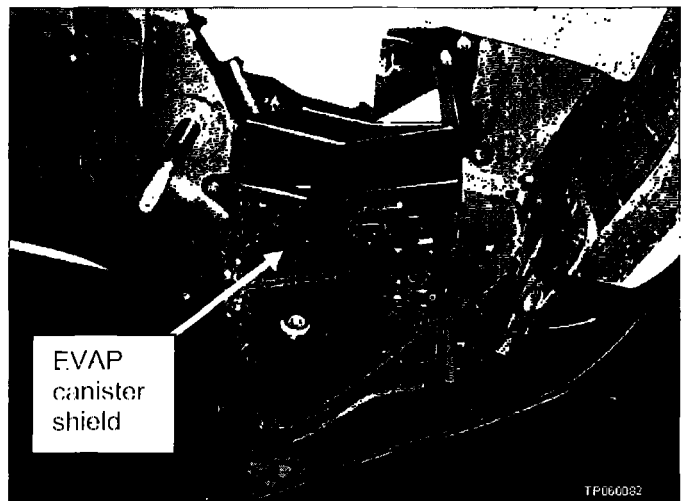

Figure 31

32. Remove and replace the four fuel hoses (provided in the kit). See Figure 32.

- Replace hoses one at a time, making sure they are correctly positioned and secured.
- Tighten the fuel filler hose clamps so that the distance between the bolt head and metal plate is set to the proper dimension (see Figure 32).

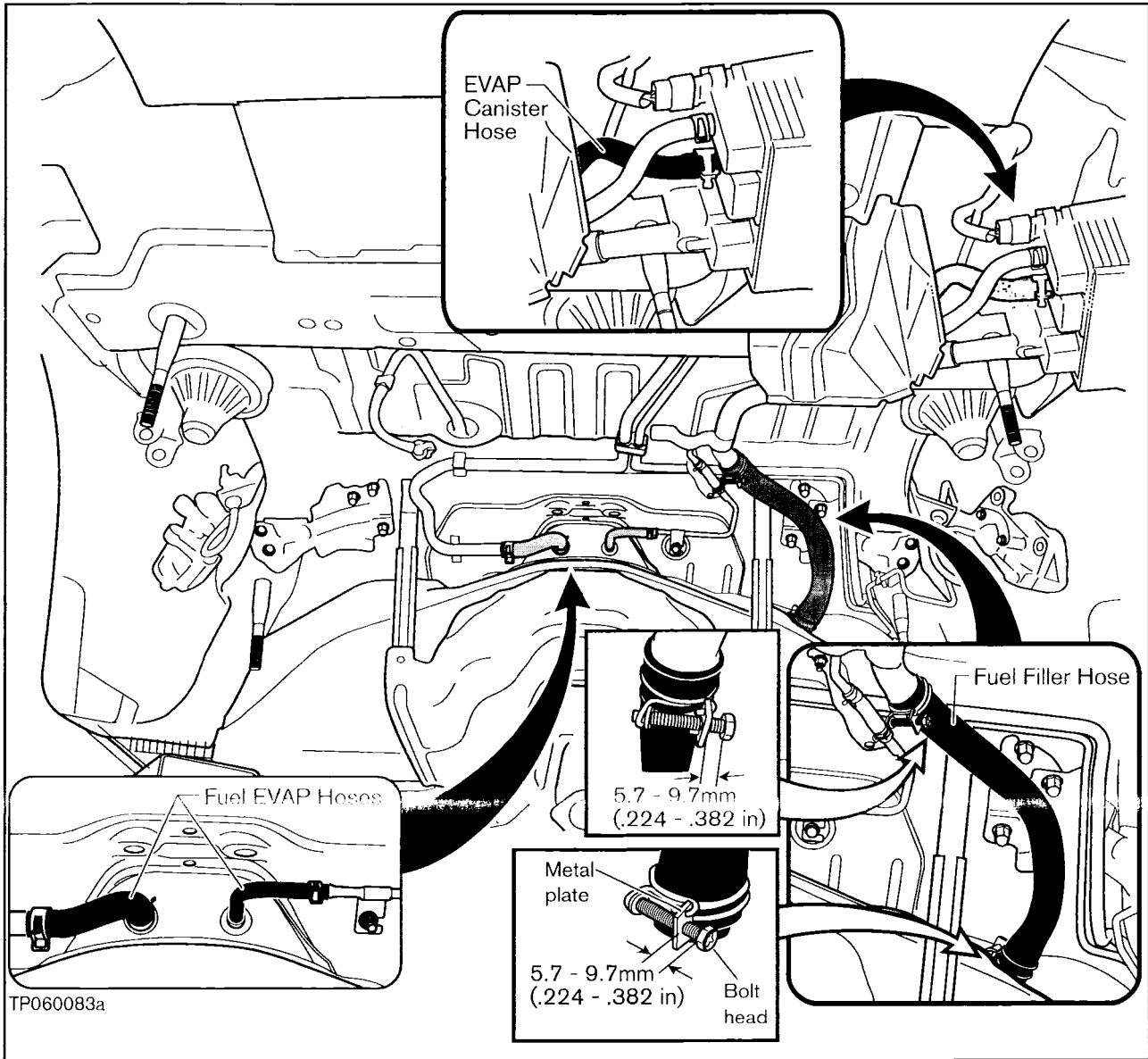

Figure 32

## Re-Assembly

33. Re-install all components in the reverse order of removal, making sure of the following:

- A. Make sure the additional support jack under the center of the front suspension member is in place and contacting the front suspension member. (see Figure 36A)

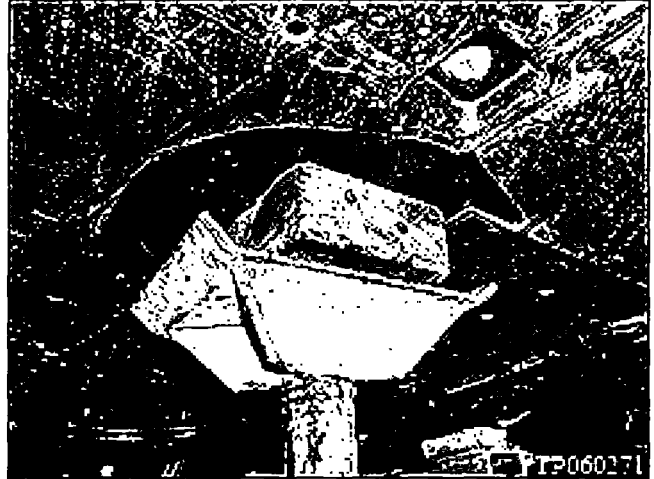

Figure 36A

- B. Raise the rear suspension assembly on the studs until approximately 1.0 inch / 25.4mm of the rear stud and approximately 1.25 inch / 31.7mm of the front stud is sticking through the mount.

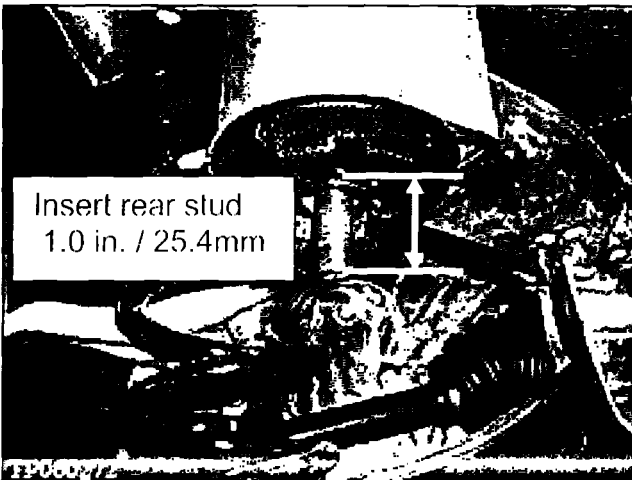

Figure 36B- Rear Mount and Stud

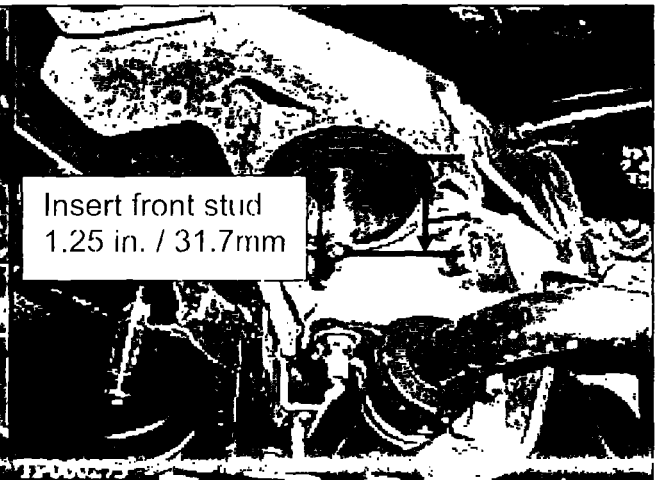

Figure 36C-Front Mount and Stud

- C. Use a single nut on each side to hold the front suspension stay bracket in place.

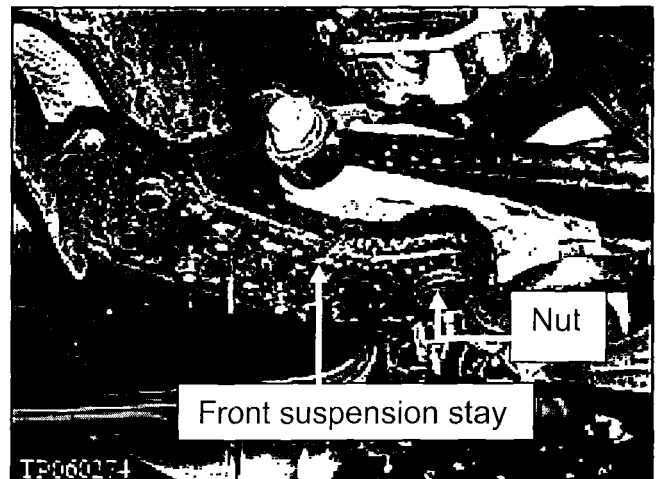

Figure 36D

- D. Use a single nut on each side to hold the rear suspension bracket in place.

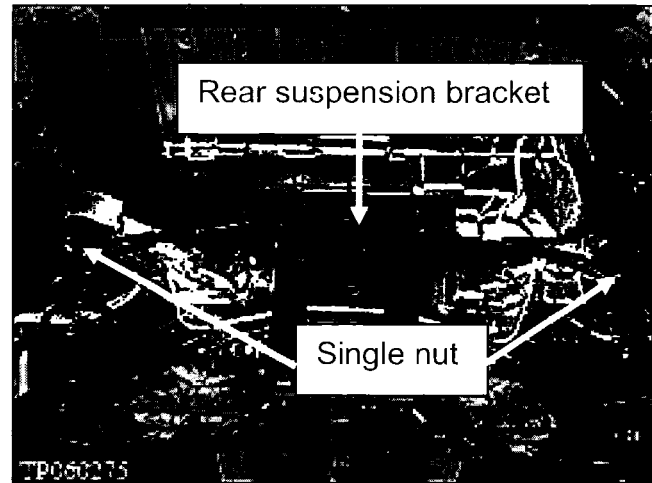

Figure 36E

- E. Use a support jack to raise one corner of the rear suspension assembly until the bushing assembly is flush to the body. Tighten the nut until the nut contacts the bushing inner sleeve.

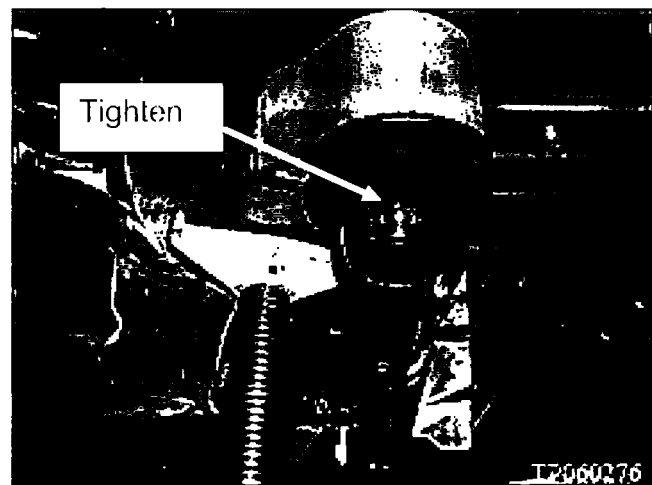

Figure 36F

- F. Repeat the same procedure on the other side.

- G. Use a support jack to raise one corner of the front suspension assembly until the assembly is flush to the body. Tighten the nut until the nut contacts the bushing inner sleeve.

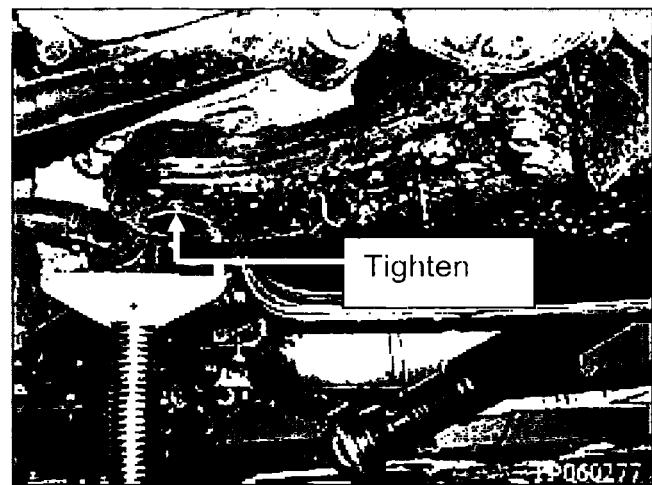

Figure 36G

- H. Repeat the same procedure on the other side.
- I. Torque the front and rear suspension mounting nuts to 110 N·m (11 kg-m, **81 ft-lb.**)



- All suspension fasteners are tightened to the proper torque specification (see Figure 33).
- All "index" marks that you made are lined up.

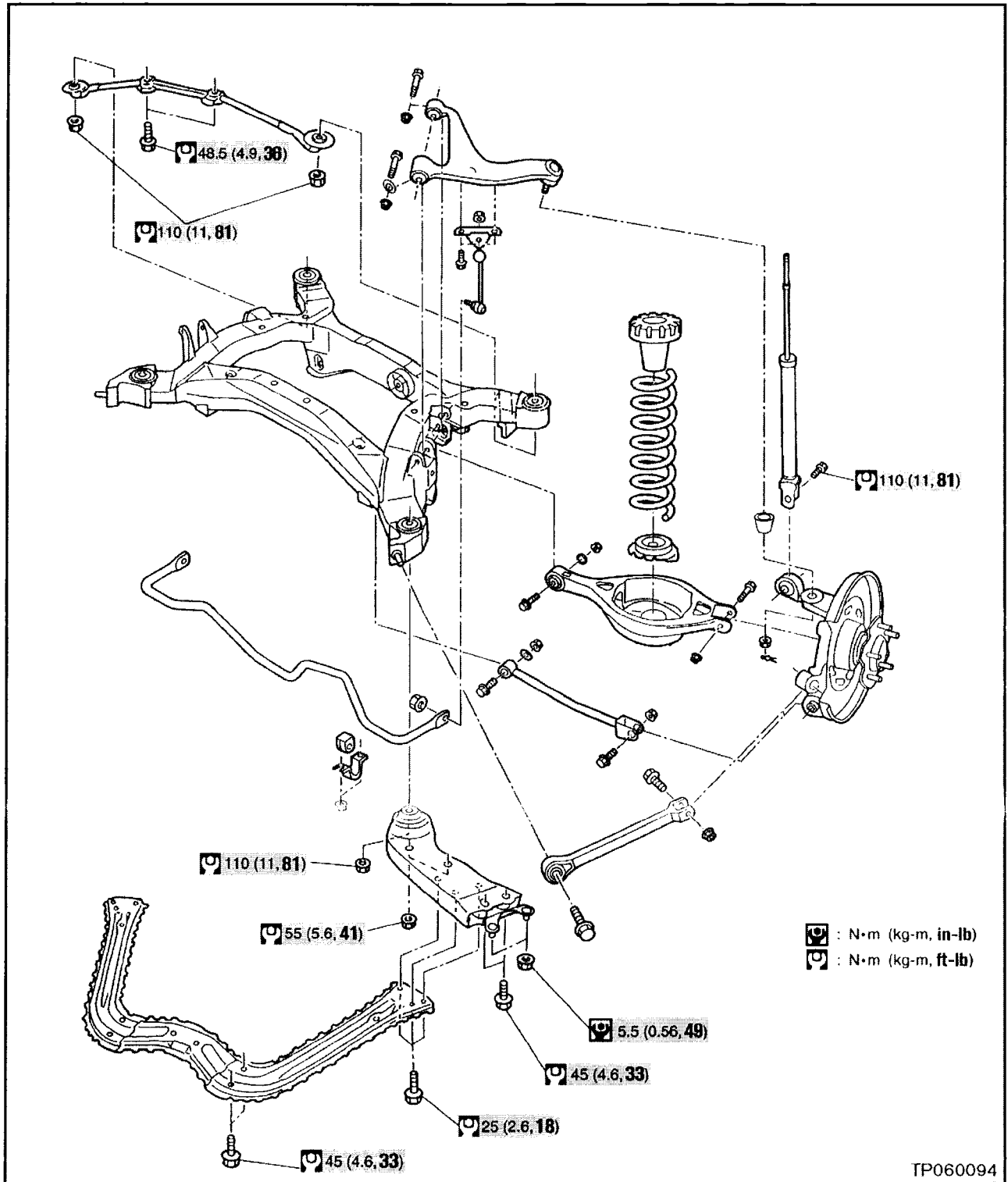

Figure 33

- Use new nuts/bolts (provided in the kit) for securing the propeller shaft to the differential pinion flange. Tighten the nuts to: 69 - 78 Nm (7.0 – 8.0 kg-m, **51 - 58 ft-lb**).
- Use a new gasket (see Parts Information) between the front and center exhaust tubes.

34. Re-connect the negative battery cable.

35. Re-program all radio station pre-sets.

### PARTS INFORMATION

DESCRIPTION	PART NUMBER	QUANTITY
Fuel Hose Kit	A7226-CD01A	1
Propeller Shaft Nut/Bolt Kit	37120-AL625	1
Gasket – Exhaust Tube	20692-65J00	1

### CLAIMS INFORMATION

Submit a Campaign (CM) line claim using the following claims coding:

“CM” I.D.: R0505

DESCRIPTION	OP CODE	FRT
RPL Fuel Vapor Hose	R05050	2.3 hrs

## OWNER'S LETTER

Dear Nissan Owner:

This notice is sent to you in accordance with the requirements of the National Traffic and Motor Vehicle Safety Act. Nissan has decided that a defect that relates to motor vehicle safety exists in some 2003-2004 model year Nissan 350Z vehicles.

### Reason for Recall

The fuel filler hose may crack and result in fuel leakage from the hose while refueling. If an ignition source is present, a fire could occur. In addition, fuel vapor hoses may crack and cause the malfunction indicator lamp to come on.

### What Nissan Will Do

Your Nissan dealer will replace the fuel filler and vapor hoses with new ones. This free service should take about three hours to complete, but your Nissan dealer may require your vehicle for a longer period of time based upon their work schedule.

### What You Should Do

Contact your Nissan dealer at your earliest convenience in order to arrange an appointment to have your vehicle repaired. Please bring this notice with you when you keep your service appointment. **It will be necessary that your fuel tank be no more than one-quarter full when you bring your vehicle to the dealer in order to minimize the possibility of fuel spill during the repair.** Instructions have been sent to your Nissan dealer. If you have additional questions you may contact the National Consumer Affairs Office, Nissan North America, Inc. at P.O. Box 191, Gardena, California 90248-0191. The toll free number is (800) 647-7261.

If you have paid to have your fuel filler or vapor hoses replaced prior to this campaign, you may be eligible for reimbursement of the related expense. You may also submit a complaint to the Administrator, National Highway Traffic Safety Administration, 400 Seventh Street, SW., Washington, DC 20590; or call the toll-free Vehicle Safety Hotline at 1-888-327-4236 (TTY: 1-800-424-9153); or go to <http://www.safercar.gov>.

Federal law requires that any vehicle lessor receiving this recall notice must forward a copy of this notice to the lessee within ten days.

Thank you for your cooperation. We are indeed sorry for any inconvenience this may cause you.

