

NISSAN

RECEIVED
MARCH 20 10 55
OFFICE
DEFECTS INVESTIGATION

NISSAN NORTH AMERICA, INC.

Corporate Office
18501 South Figueroa St.
Gardena, California 90248-4500
Mailing Address: P.O. Box 191
Gardena, California 90248-0191
Telephone: 310.532.3111

March 16, 2006

Mr. George Person
Chief, Recall Analysis Division
Office of Defects Investigation
Safety Assurance
National Highway Traffic Safety Administration
400 Seventh Street, S.W.
Washington, D.C. 20590

Ref: 05V-555

Dear Mr. Person:

The enclosed communication is being provided pursuant to 49 CFR Part 573.6(c)(9).

Technical Compliance Department

Encl.



Reference:

ITB06-006a

Date:

March 9, 2006

VOLUNTARY RECALL CAMPAIGN FUEL HOSES

This bulletin has been amended. The special jack adaptor tool number has changed from J-47441 to J-47441-A. A note for installing this tool on the G35 sedan has been added to the procedure. Please discard all previous versions of this bulletin.

CAMPAIGN I.D. # / NHTSA #: R0508 / 05V-555

APPLIED VEHICLES: 2003-04 G35 Coupe (CV35)
2003-04 G35 Sedan (V35)
2003-04 FX35 (S50)
2003-06 FX45 (S50)

APPLIED VINS: G35 Coupe: JNKCV54E*3M200022 - 226707
JNKCV54E*4M300013 - 310126
G35 Sedan: JNKCV51E*3M000014 - 336214
JNKCV51E*4M100021 - 114488
FX35 / FX45: JNRAS08U*3X000014 - 103692
JNRAS08W*3X000010 - 208839
JNRBS08W*3X000020 - 404880
JNRAS08U*4X100002 - 101374
JNRAS08W*4X200005 - 203919
JNRBS08W*4X400003 - 405193
JNRBS08W*5X400004 - 402790
JNRBS08W*6X400013 - 400043

NOTE: Use Service Comm to confirm campaign eligibility.

INTRODUCTION

Infiniti has determined that some 2003–2004 model year Infiniti G35 sedan/coupe vehicles and 2003-2006 model year Infiniti FX35/45 vehicles may have a defect which relates to motor vehicle safety. There is the possibility that the fuel filler hose may crack and result in fuel leakage from the hose while refueling. If an ignition source is present, a fire could occur. In addition, fuel vapor hoses may crack and cause the malfunction indicator lamp to come on. To prevent this condition from occurring, Infiniti is conducting a Voluntary Safety Recall Campaign to replace the fuel filler and vapor hoses with new ones.

IDENTIFICATION NUMBER

Nissan has assigned identification number R0508 to this campaign. This number must appear on all communications and documentation of any nature dealing with this campaign.

NUMBER OF VEHICLES POTENTIALLY AFFECTED

The number of vehicles potentially affected is approximately 138,800.

DEALER RESPONSIBILITY

It is the retailer's responsibility to check Infiniti Net for the campaign status on each vehicle falling within the range of this voluntary safety recall which for any reason enters the service department. This includes vehicles purchased from private parties or presented by transient (tourist) owners and vehicles in a dealer's inventory. **Federal law requires that new vehicles in dealer inventory which are the subject of a safety recall must be corrected prior to delivery under a sale or lease. Failure to do so can result in civil penalties by the National Highway Traffic Safety Administration.** While federal law applies only to new vehicles, Infiniti strongly encourages dealers to correct any used vehicles in their inventory before they are retailed.

Repair Overview

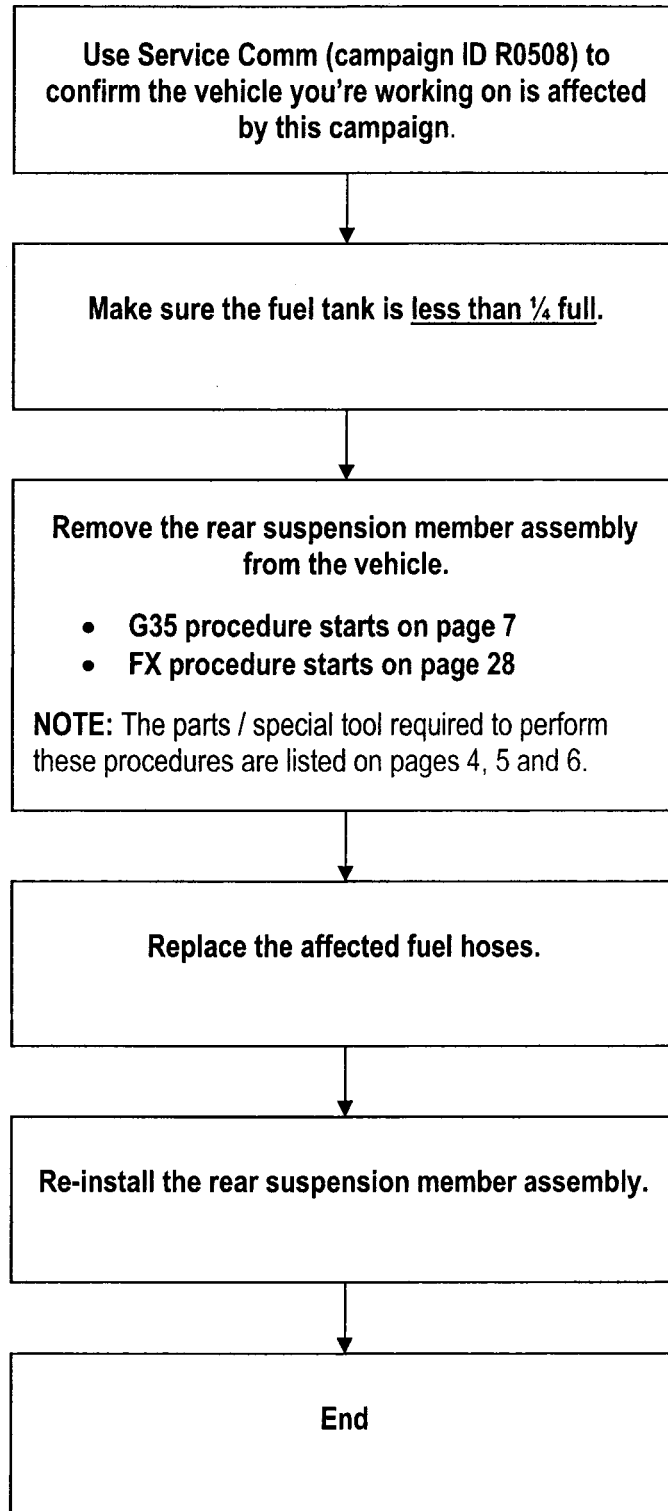

Required Parts for G35 Coupe and G35 Sedan

(Refer to the Parts Information section for the part numbers.)

- Fuel hose kit (see Figure 1a)

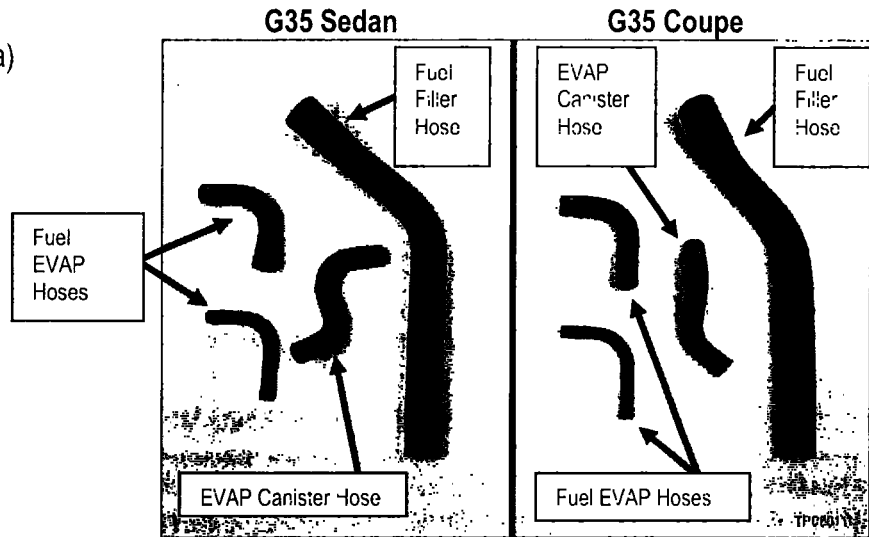

Figure 1a

- Propeller shaft bolt kit (see Figure 1b)

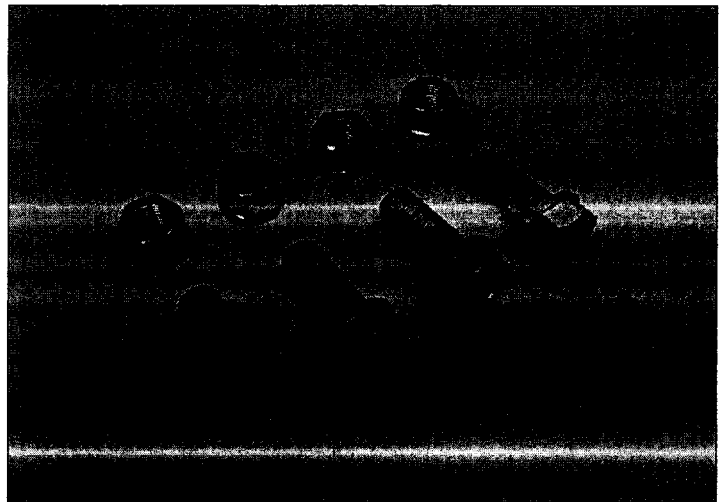

Figure 1b

- Exhaust tube gasket (see Figure 1c)

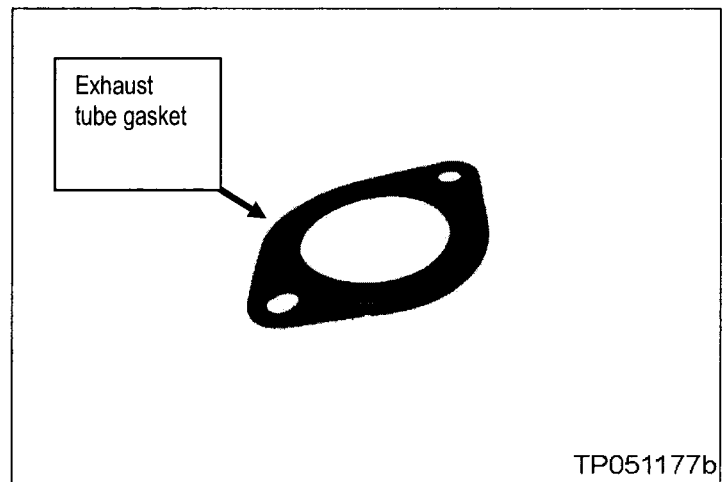

Figure 1c

TP051177b

Required Parts for FX35 and FX45

(Refer to the Parts Information section for the part numbers.)

- Fuel hose kit (see Figure 1d)

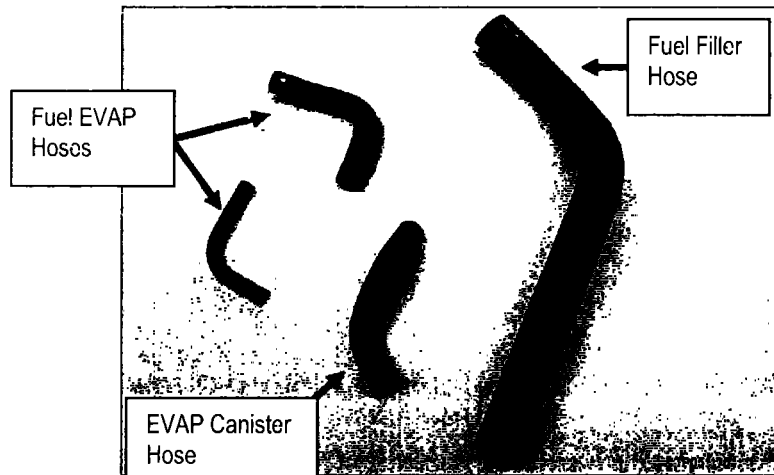

Figure 1d

- Propeller shaft bolt kit (see Figure 1e)

NOTE: There are two bolt kits available for the FX. Refer to the Parts Information section for ordering details.

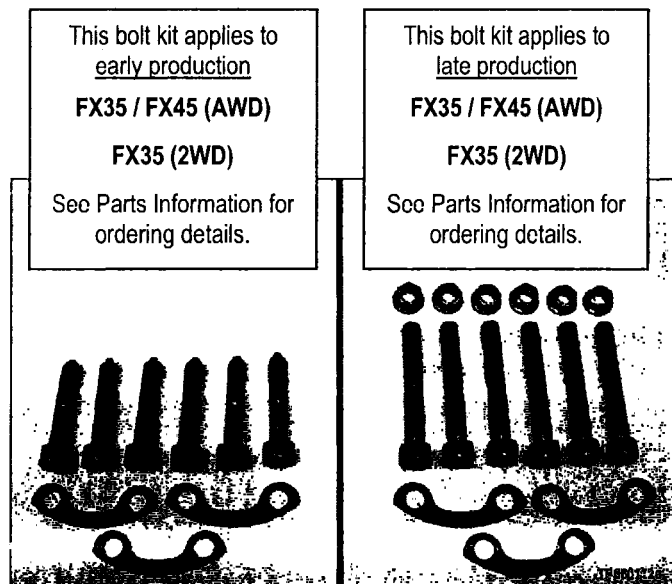

Figure 1e

- Propeller shaft center bearing nuts (see Figure 1f)
- Exhaust tube nuts (see Figure 1f)
- Exhaust tube gasket (see Figure 1f)

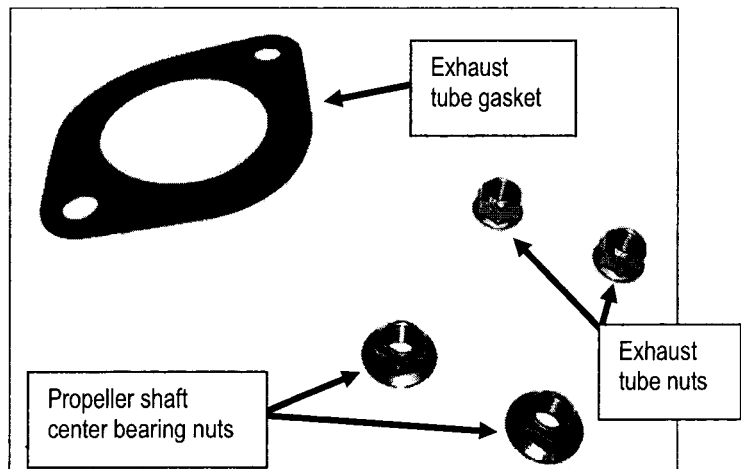

Figure 1f

Required Special Tool for All Models (sent to each dealer)

The essential Jack Adapter Tool J-47441-A will be needed to perform these procedures.

- If you are using an OTC 16-1728 high lift transmission jack, use adapter block J-47002-4 between the jack and the jack adapter tool J-47441-A.
- The adapter block is part of essential tool J-47002 transmission jack adapter kit.

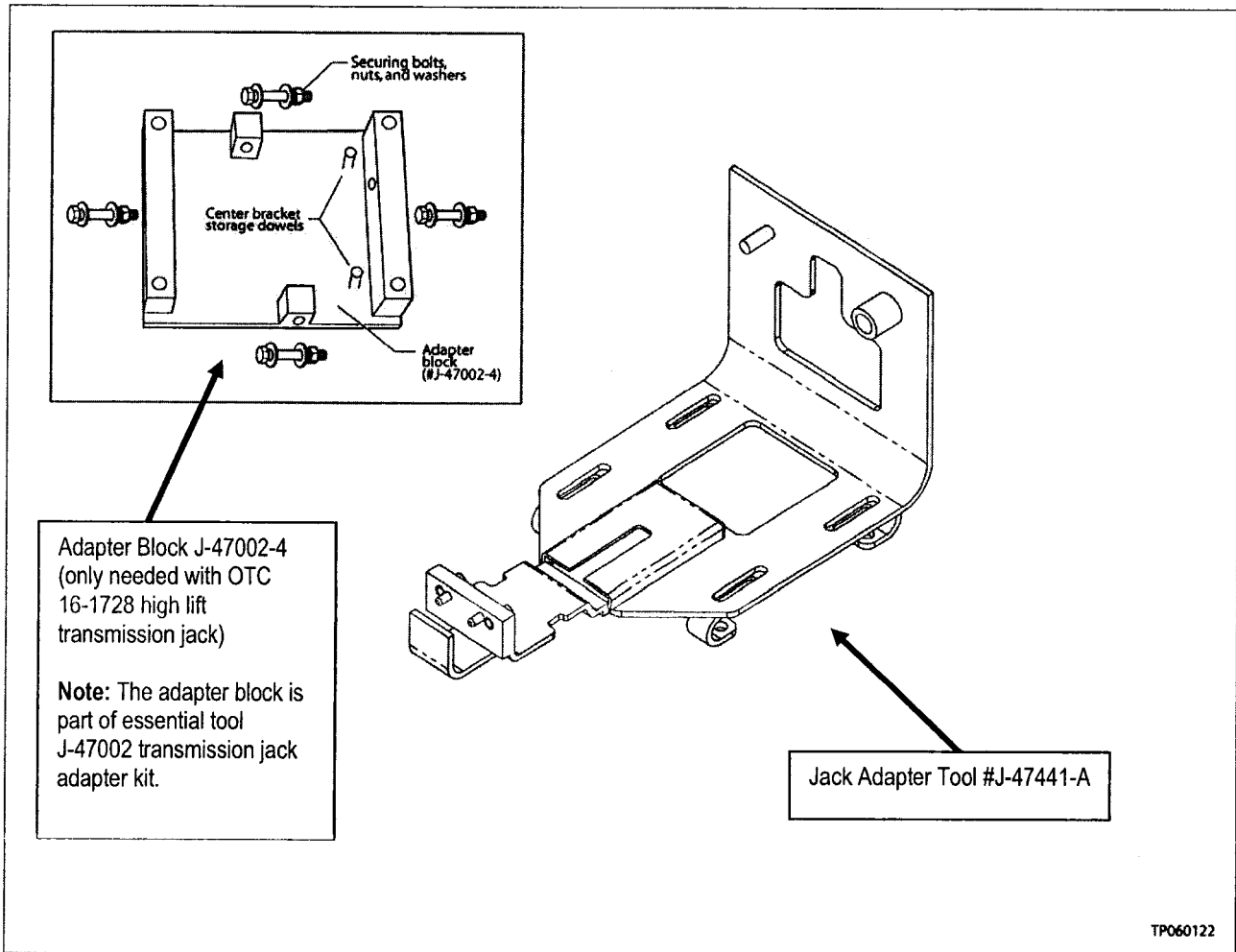

Figure 1g

NOTE: Replacement tools can be ordered from Nissan TECH-MATE at 1-800-662-2001.

SERVICE PROCEDURE (G35 Coupe and G35 Sedan)

NOTE: Refer to page 28 for the FX35 and FX45 service procedure.

Remove the rear suspension member assembly and replace four fuel hoses (from the kit) as follows.

Preliminary Steps

1. Record all radio station presets.
2. Disconnect the negative battery cable.
3. Raise the vehicle on a hoist.

NOTE: Make sure you release the parking brake.

Remove Rear Wheels/Brake Calipers

4. Remove both rear wheels/tires.
5. Remove both brake calipers and hang them from the brake line supports with wire (see Figure 2).

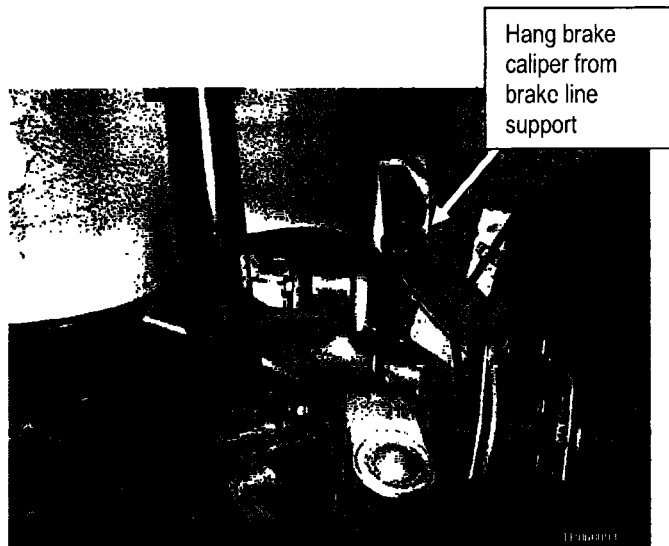

Figure 2

Remove Center Exhaust Tube/Rear Muffler

G35 Coupe Procedure ONLY (steps 6 through 17)

NOTE: For the G35 Sedan procedure, perform steps 18 through 22 (starting on page 13).

6. Remove the exhaust system ground strap from the muffler stud/nut (see Figure 3).

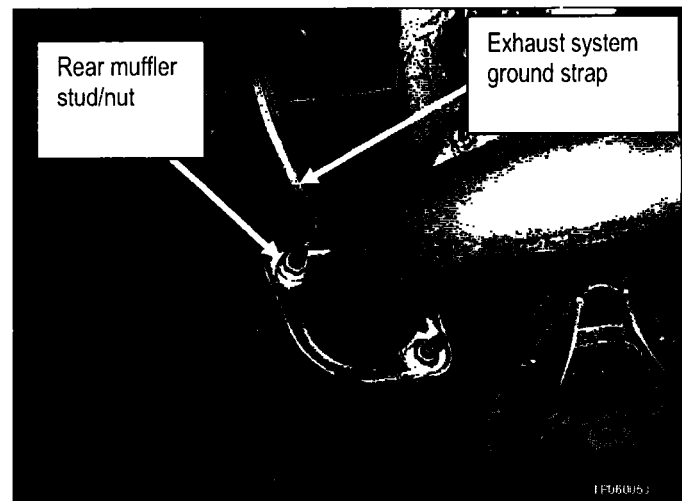

Figure 3

7. On the passenger (RH) side: remove two bolts and one clip and remove the rear plastic under cover (see Figure 4).

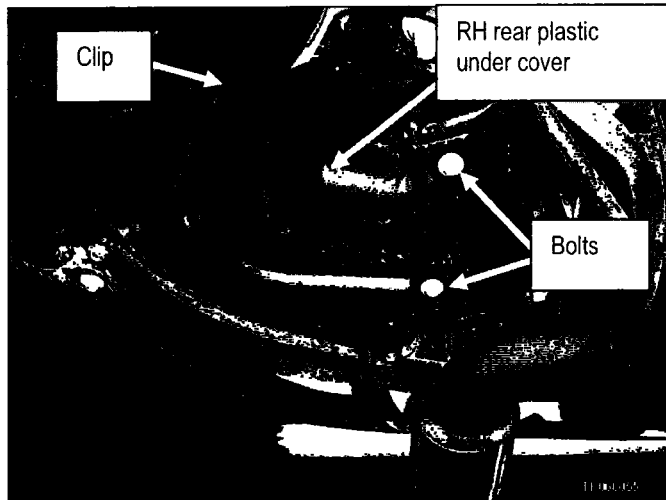

Figure 4

8. Below the plastic cover you just removed: remove three bolts and remove the passenger (RH) side rear metal cover (see Figure 5).

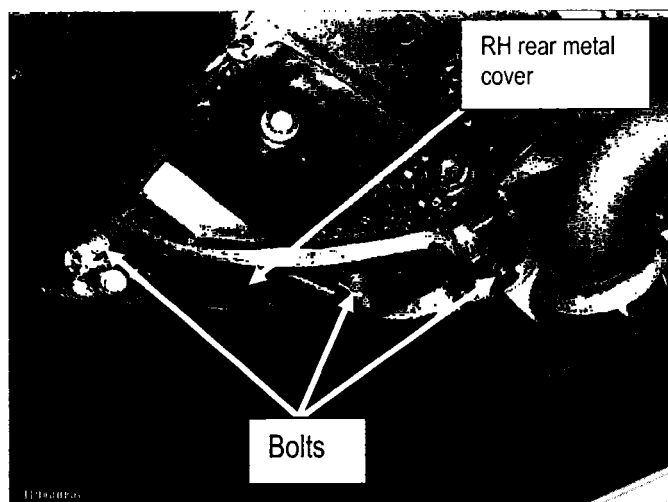

Figure 5

9. On the driver's (LH) side: remove two nuts and one clip and remove the rear plastic under cover (see Figure 6).

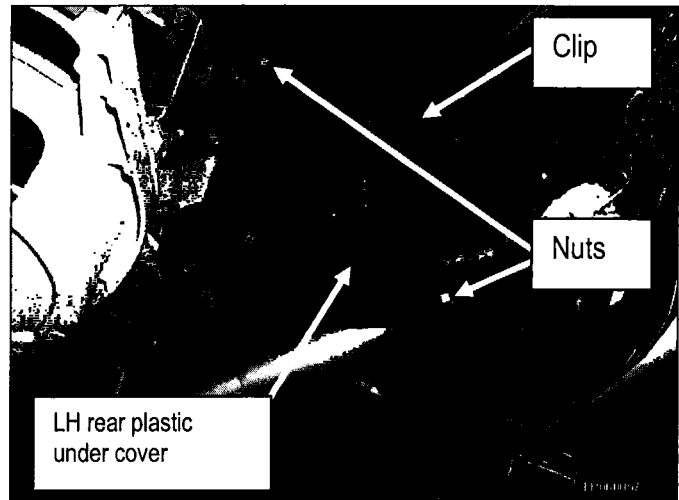

Figure 6

10. Below the plastic cover you just removed: remove two bolts and one clip and remove the driver's (LH) side rear metal cover (see Figure 7).

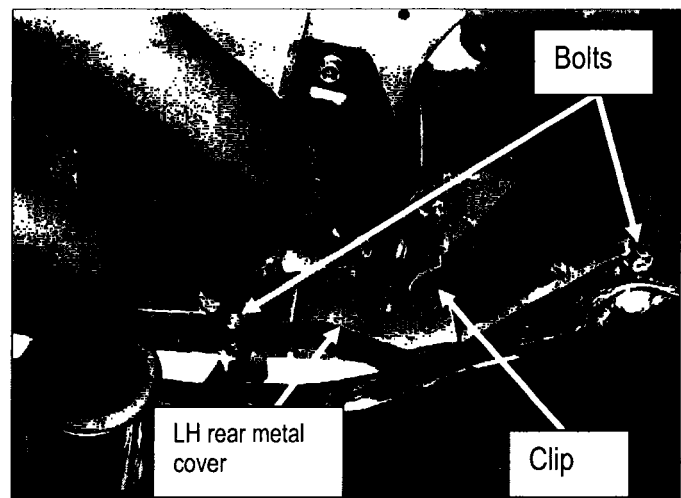

Figure 7

11. Remove nuts and bolts and remove the tunnel "stay" side covers and the tunnel "stay" bracket (see Figure 8).

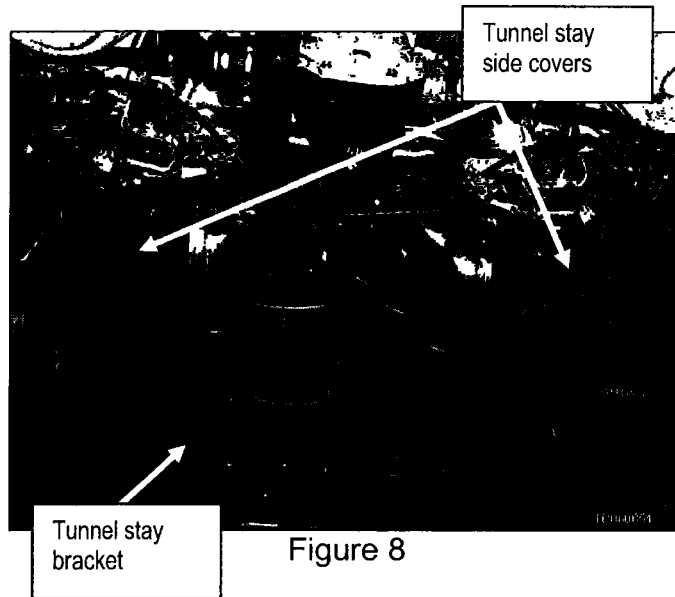

Figure 8

12. Remove the nut that holds the center muffler mount bracket (see Figure 9).

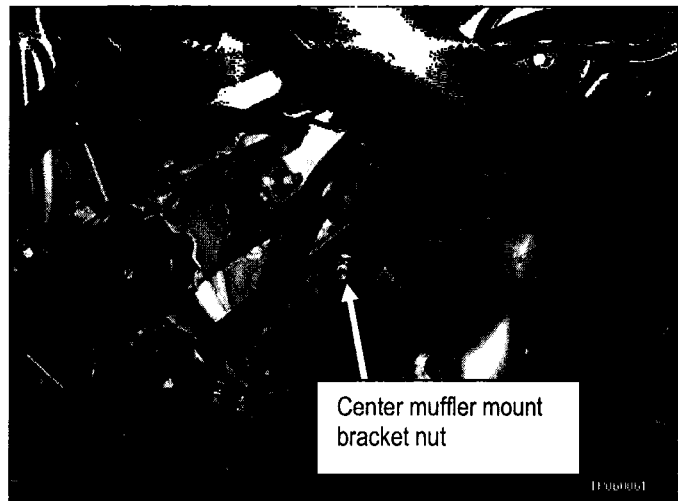

Figure 9

13. Remove the bolt that holds the passenger (RH) side rear muffler mount bracket (see Figure 10).

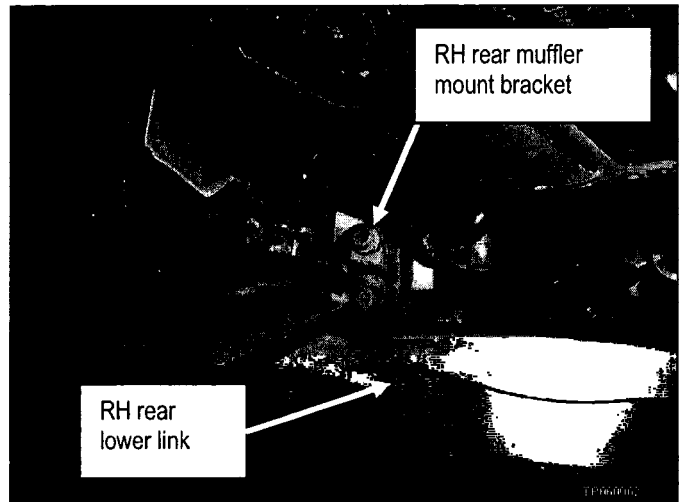

Figure 10

14. Remove the exhaust system center tube front nuts (see Figure 11).



Figure 11

15. Support the rear muffler with a support jack (see Figure 12).

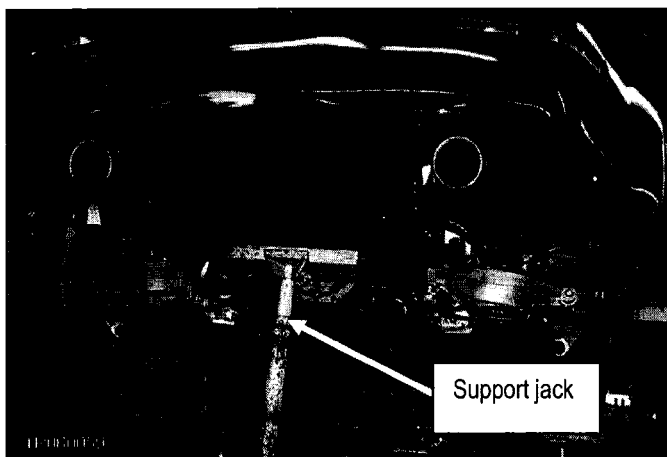

Figure 12

16. Remove the rear muffler bracket bolts (see Figure 13a and 13b).



Figure 13a

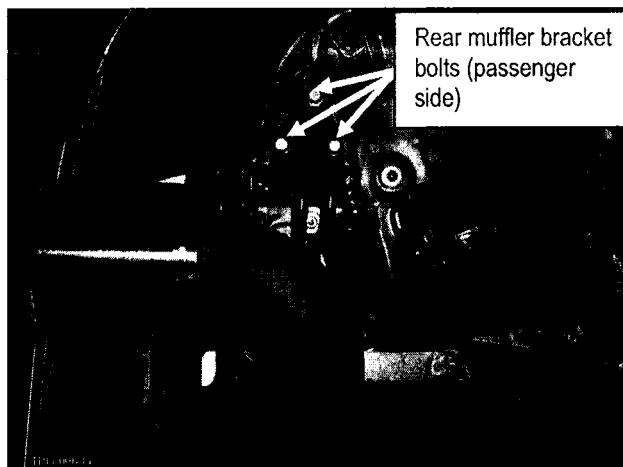

Figure 13b

17. Carefully remove the exhaust center tube/rear muffler and place it in a safe location (see Figure 14).

NOTE: Continue with step 23 (Reposition Propeller Shaft) for the G35 Coupe and G35 Sedan.

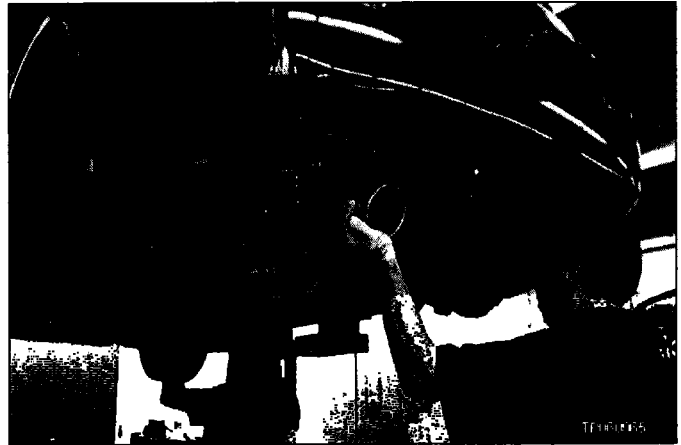

Figure 14

G35 Sedan Procedure ONLY (steps 18 through 22) - for removing center exhaust tube / rear muffler

NOTE: For the G35 Coupe procedure, go back to steps 6 through 17 (starting on page 7).

18. Place a support jack under the rear muffler.
19. Remove the three bolts that hold the rear muffler hanger bracket to the vehicle body (see Figure 15).

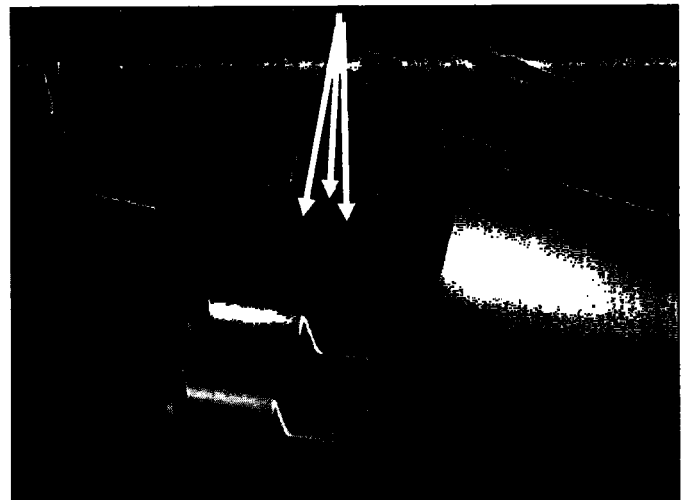

Figure 15

20. Remove the nuts that hold the center muffler mount brackets to the vehicle body (see Figure 16).

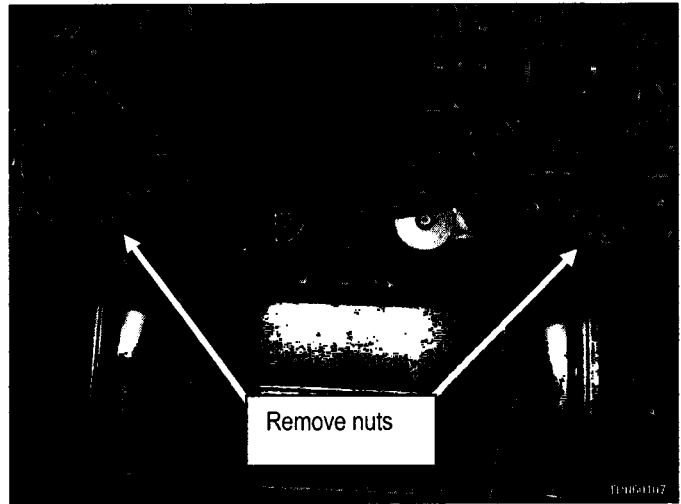

Figure 16

21. Remove the exhaust system center tube front nuts (see Figure 17).
22. Carefully remove the exhaust center tube/rear muffler and place it in a safe location.

NOTE: Continue with step 23 for the G35 Coupe and G35 Sedan "Reposition Propeller Shaft" procedure.

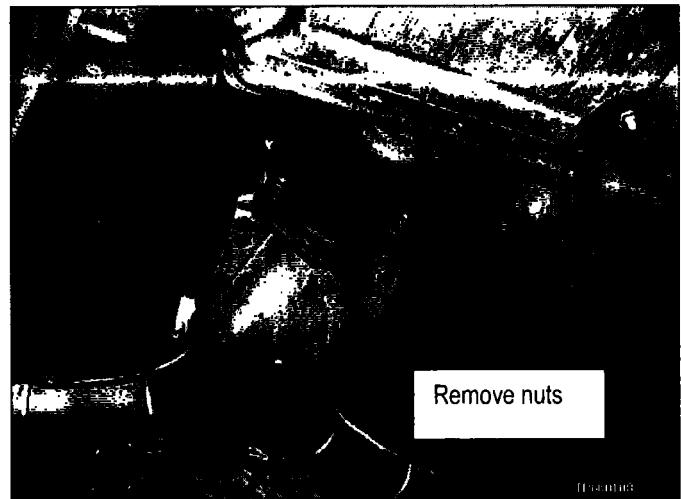

Figure 17

Re-position Propeller Shaft

23. If applicable, remove four nuts and remove the tunnel brace (see Figure 18).

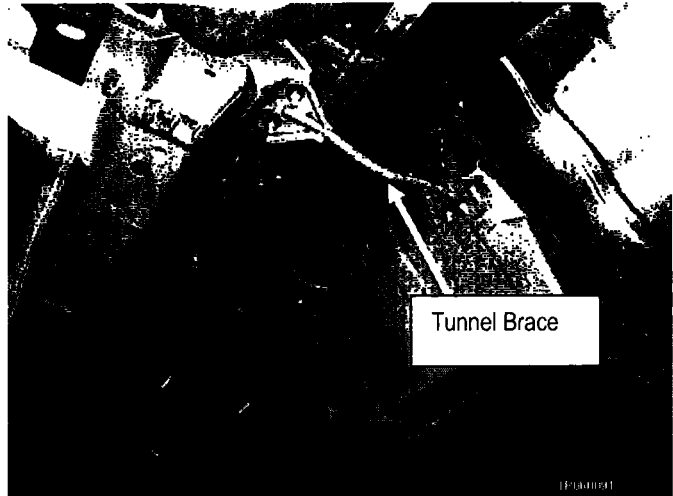

Figure 18

24. Apply an "index" (line up) mark across the propeller shaft and differential pinion flange for correct re-assembly (see Figure 19a).
25. Remove four nuts and bolts and **carefully** re-position the propeller shaft down and to one side. Use a piece of wire to support the propeller shaft to avoid excessive tension on the propeller shaft center bearing (see Figure 19b).



Figure 19a

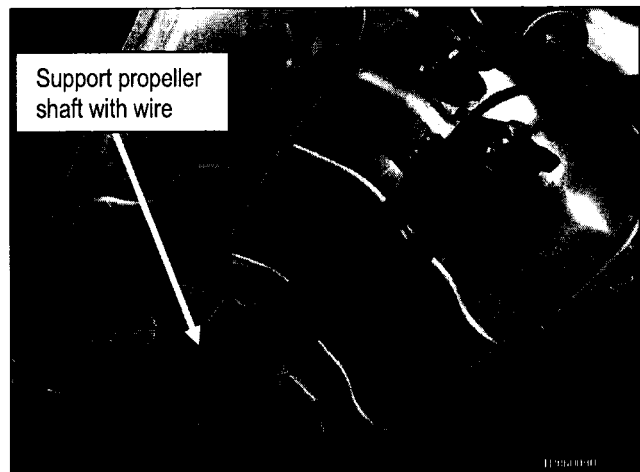

Figure 19b

Disconnect Parking Brake Cables

26. Disconnect the parking brake cables as follows:
 - a. Remove the nuts that hold the parking brake cable brackets to the rear suspension member (see Figure 20).

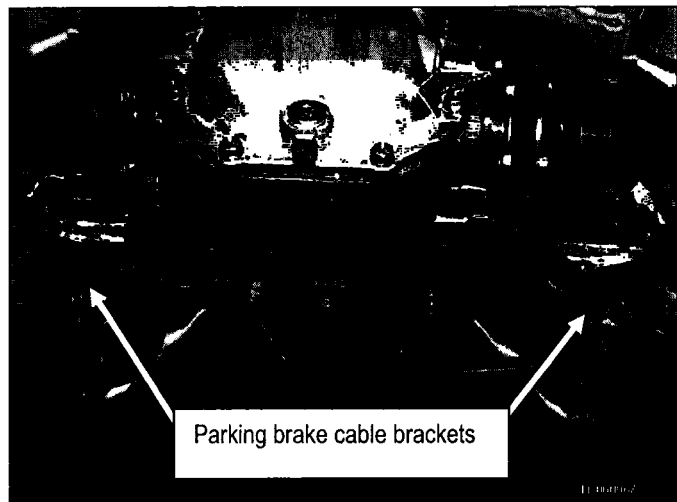

Figure 20

- b. Remove the cables from the metal support brackets (see Figure 21).

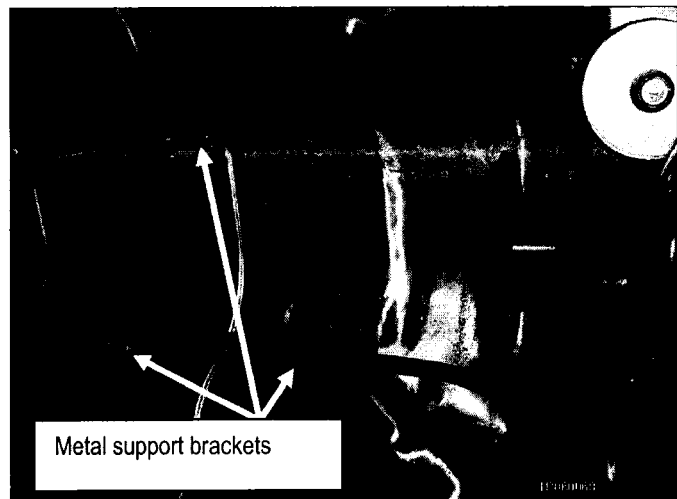

Figure 21

- c. Remove the nuts that hold the parking brake cables to the vehicle body (see Figure 22).
- d. Disconnect the cables from the front equalizer (see Figure 22).

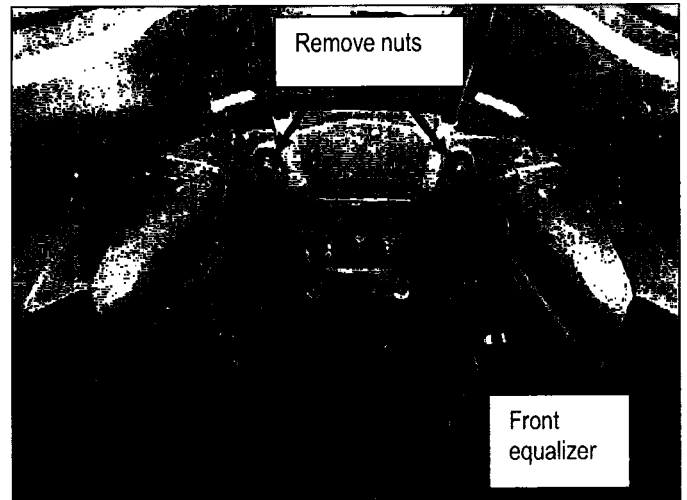

Figure 22

Disconnect ABS Harness Connector/Remove Tie Wrap

27. Disconnect the ABS harness connector (see Figure 23a). Then remove the tie wrap from the suspension member using a pair of needle-nose pliers (see Figure 23b).
- If you accidentally break the tie wrap, install a new one at re-assembly. The tie wrap part number is 24225-89960.

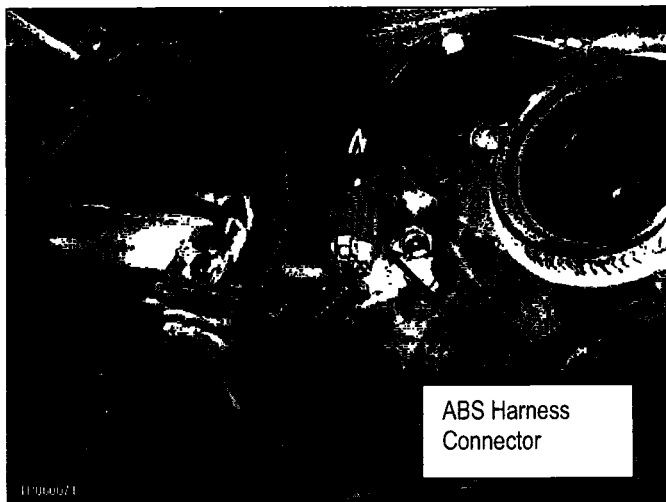

Figure 23a



Figure 23b

Disconnect Shock Absorber From Knuckle

28. Place a support jack under the rear lower link. Then remove the bolt that holds the shock absorber to the knuckle (see Figure 24).

NOTE: Do NOT disconnect the shock absorber from the body at the top of the wheel well.

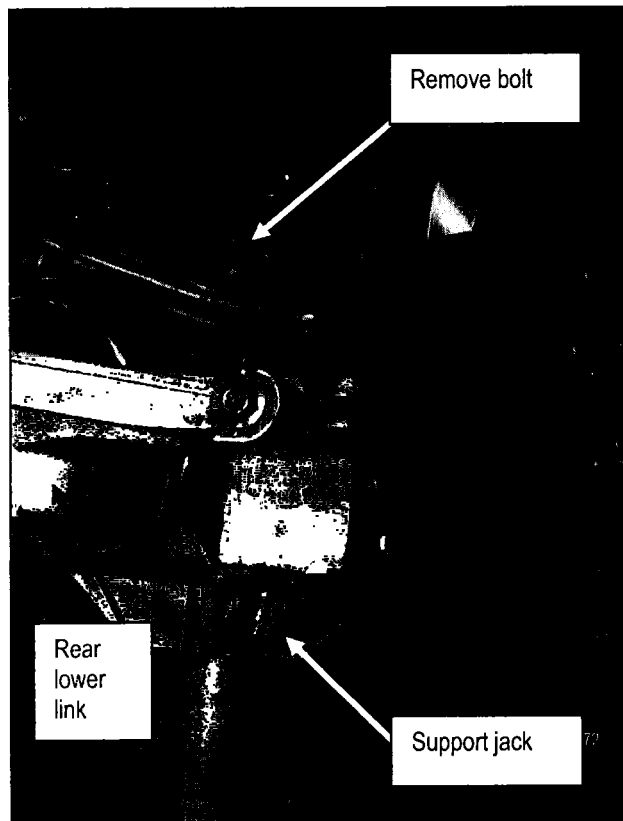

Figure 24

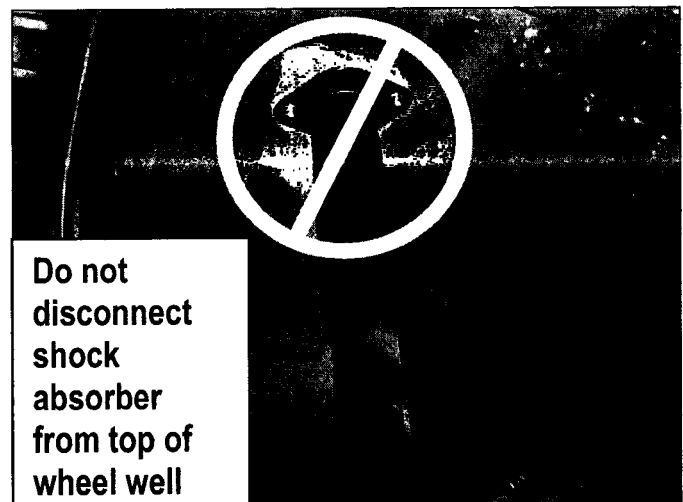

Figure 25

29. Place an index mark across the bushing and cross bar for proper re-assembly (see Figure 26).

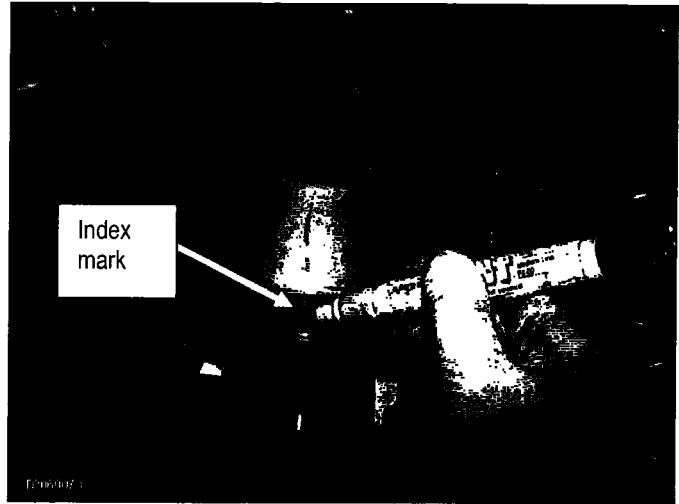

Figure 26

Install Jack Adapter Tool #J-47441-A to Differential

NOTE: For G35 Sedan only, the four main suspension member nuts must be lowered before installing the Jack adaptor. This will allow the jack adaptor to clear the spare tire wheel-well.

Rear Suspension Member Nuts

- Support the suspension member with a jack stand near the left rear nut.
- Lower the nut until only 1 or 2 threads are showing below the nut (see Figure 26a).
- Lower the jack stand.
- Perform a, b, and c above for the right rear nut.

CAUTION: Do not completely remove the nuts.

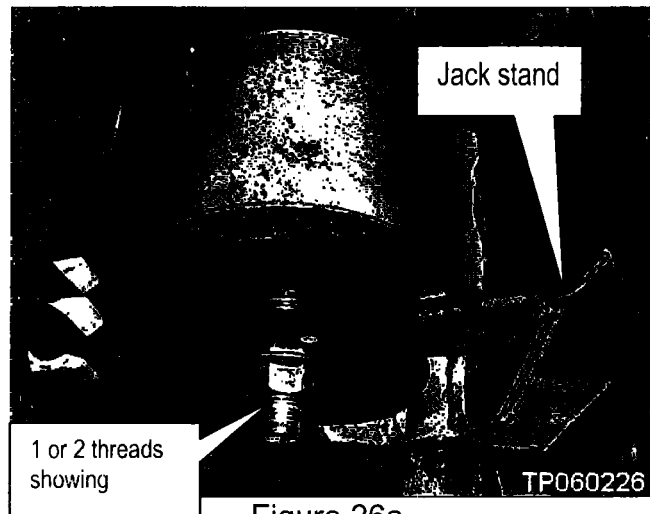

Figure 26a

Front Suspension Member Nuts

- Support the suspension member with a jack stand near the left front nut.
- Lower the nut to about the middle of its travel (see Figure 26b).
- Lower the jack stand.
- Perform a, b, and c above for the right front nut.

CAUTION: Do not completely remove the nuts.

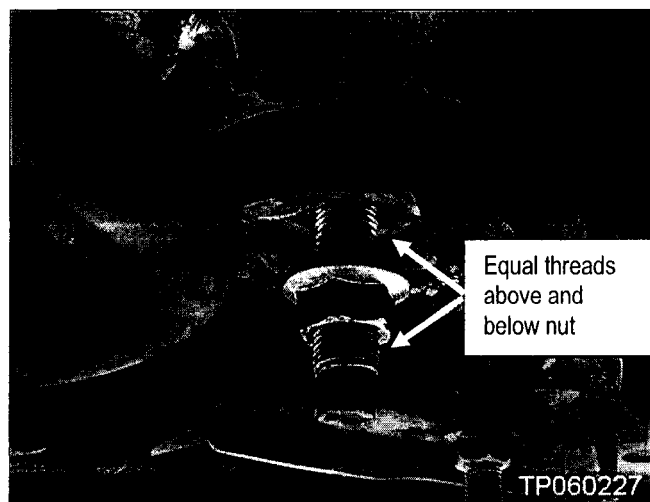

Figure 26b

30. Install the jack adapter tool #J-47441-A to the differential pinion flange and suspension member as follows:

- Install part "A" of the adapter tool onto the pinion flange. Make sure both pins on the tool are inserted into the pinion flange bolt holes (see Figure 27).

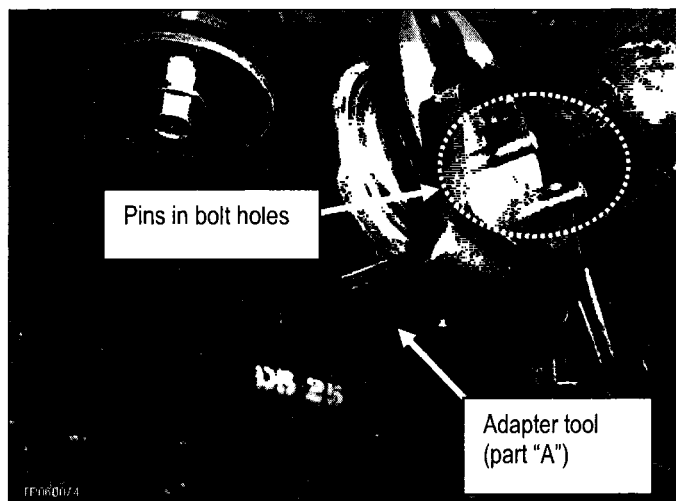

Figure 27

- b. Slide part "B" of the adapter tool over the rear of part "A". Then, insert the locator pins at the upper corners of the tool into the rear suspension member (see Figure 28).

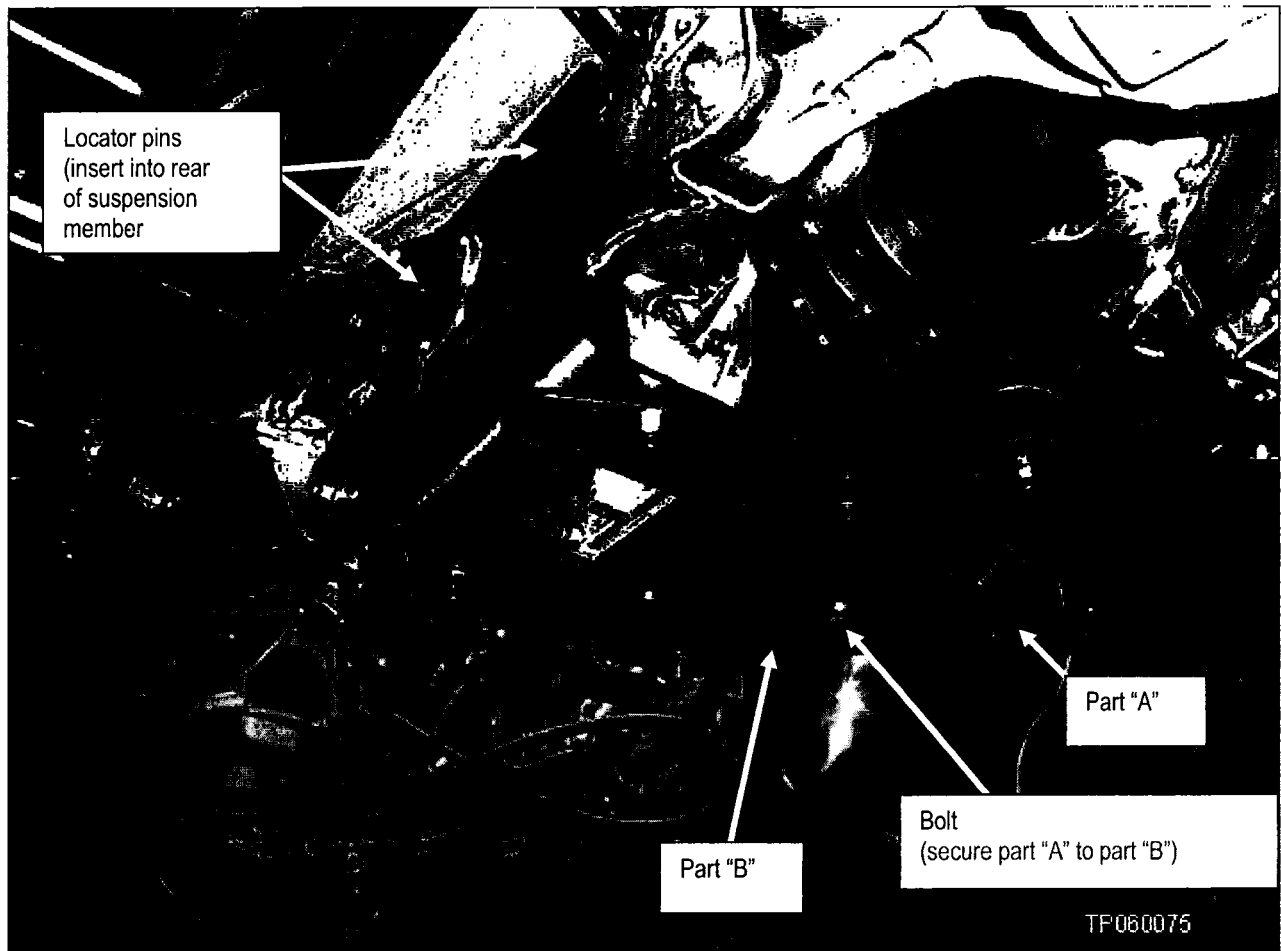

Figure 28

Remove Rear Suspension Member

31. Use bolts to attach a transmission jack to the adapter tool (see Figure 29).



Figure 29

32. Place an additional support jack under the front suspension member to help stabilize the vehicle on the lift (see Figure 30).

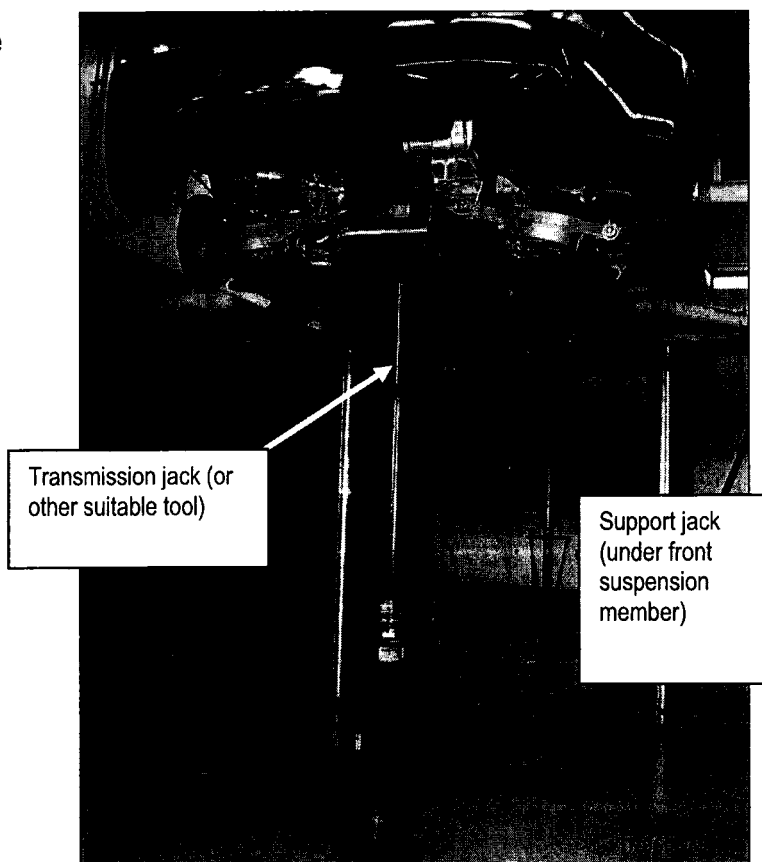

Figure 30

33. Place an index mark across the coil spring and upper spring seat for proper re-installation (see Figure 31).

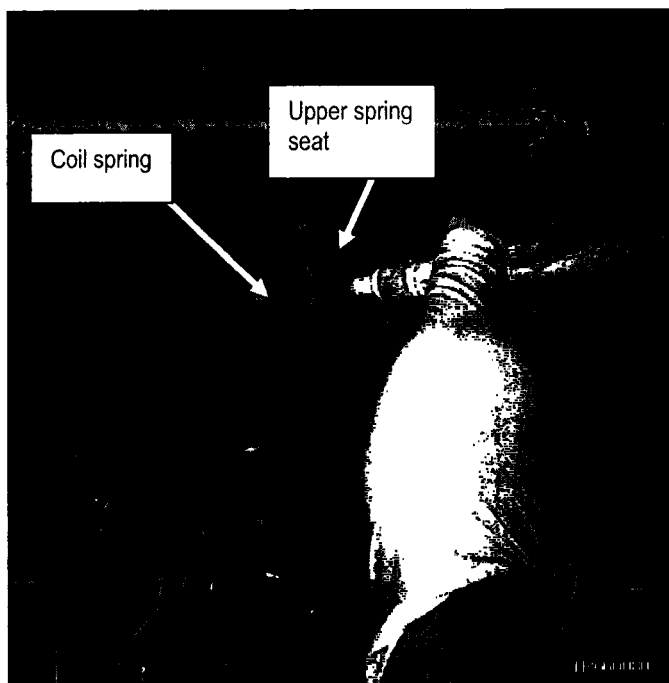
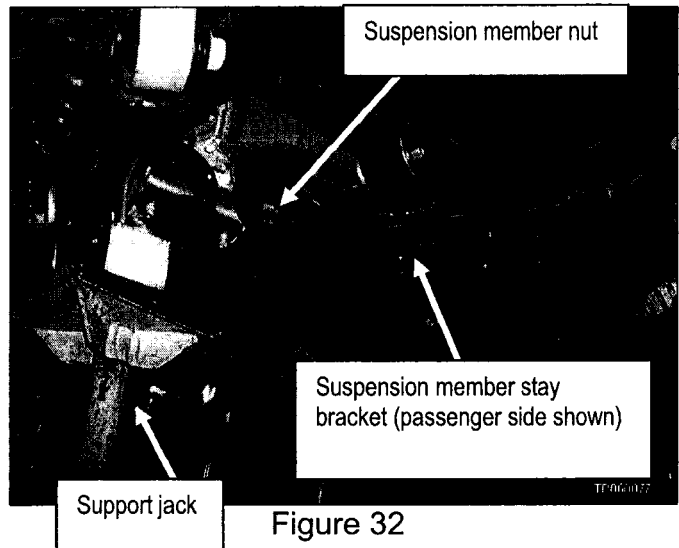

Figure 31

34. Place a support jack under the rear suspension member.

- Then remove the bolts and nuts that hold the suspension member "stay" brackets (both passenger and driver's side brackets). See Figure 32.
- Slowly lower the support jack and remove the stay brackets.

NOTE: The larger nuts hold the suspension member.



35. Remove the bolts and nuts and remove the rear stay bracket (see Figure 33).

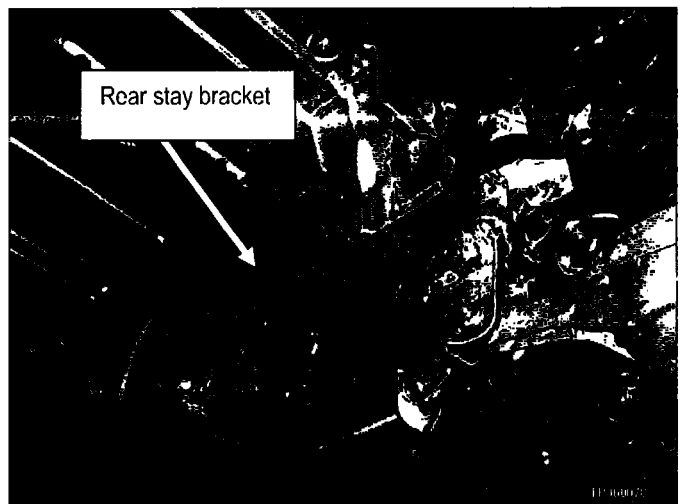

36. Carefully lower the suspension member (see Figure 34) and place it in a safe location away from "traffic".

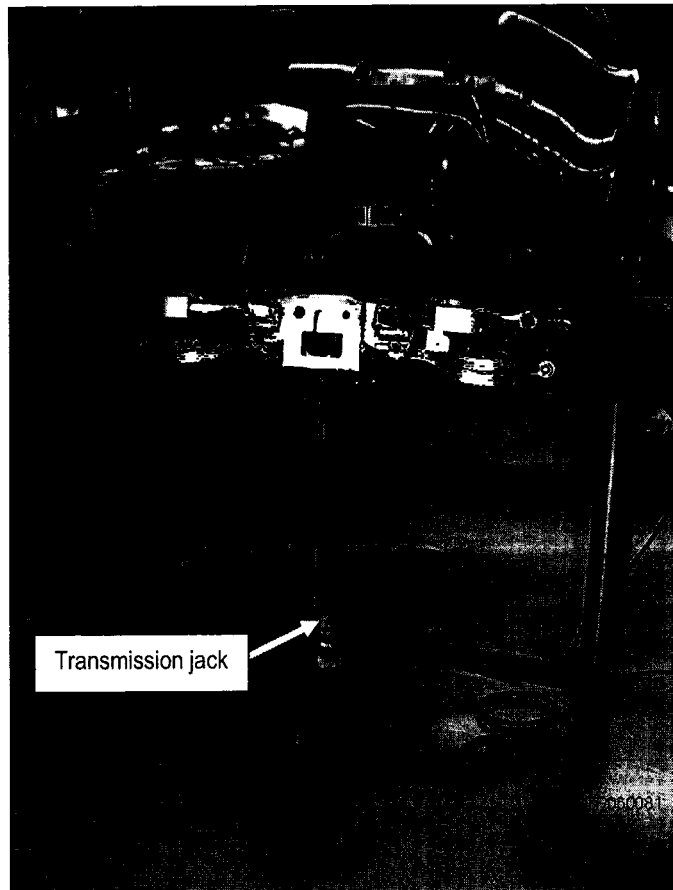

Figure 34

Install Fuel Hoses

CAUTION: Make sure the fuel tank is less than 1/4 full before you perform this procedure.

37. Remove three nuts and remove the evaporative canister shield (see Figure 35).

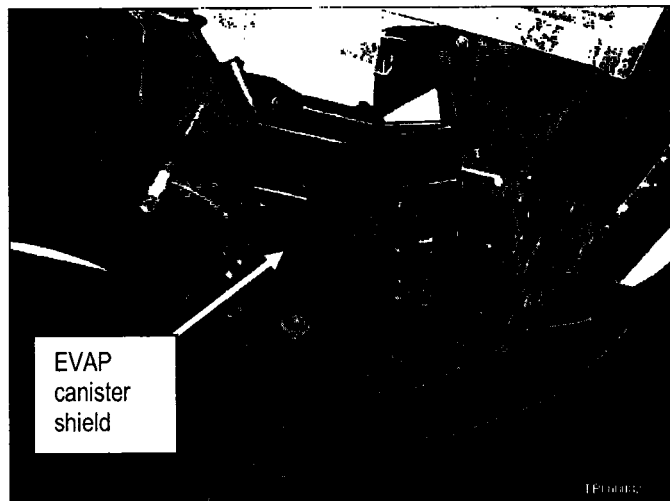

Figure 35

38. Remove and replace the four fuel hoses (provided in the kit). See Figure 36.

- Replace hoses one at a time, making sure they are correctly positioned and secured.
- Tighten the fuel filler hose clamps so that the distance between the bolt head and metal plate is set to the proper dimension (see Figure 36).

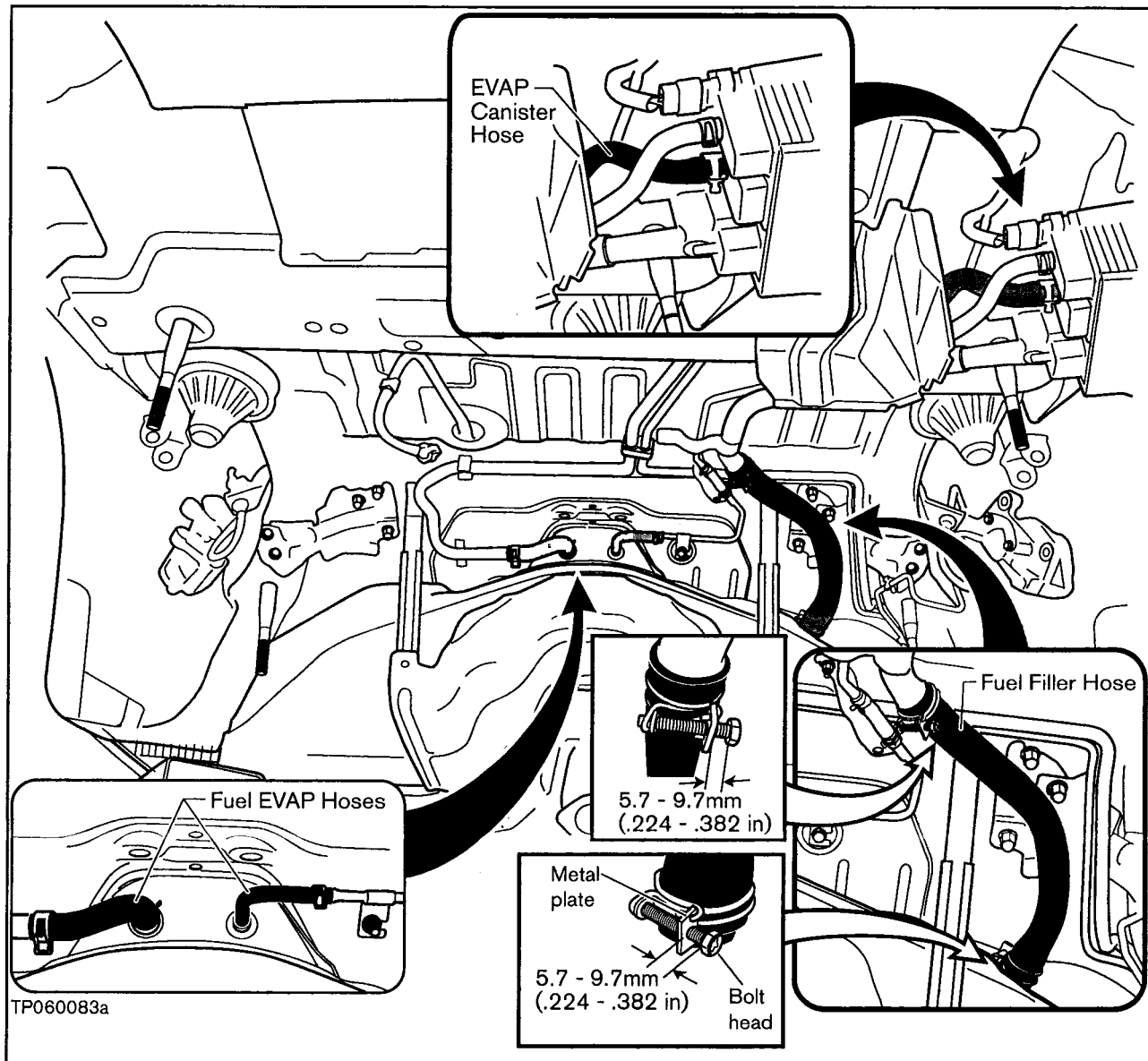

Figure 36

Re-Assembly

39. Re-install all components in the reverse order of removal, making sure of the following:

NOTE: For removing the jack adaptor on a G35 sedan, reverse the order of installation on page 20.

- All highlighted suspension fasteners are tightened to the proper torque specification (see Figures 37 and 38).
- All "index" marks that you made earlier are lined up.

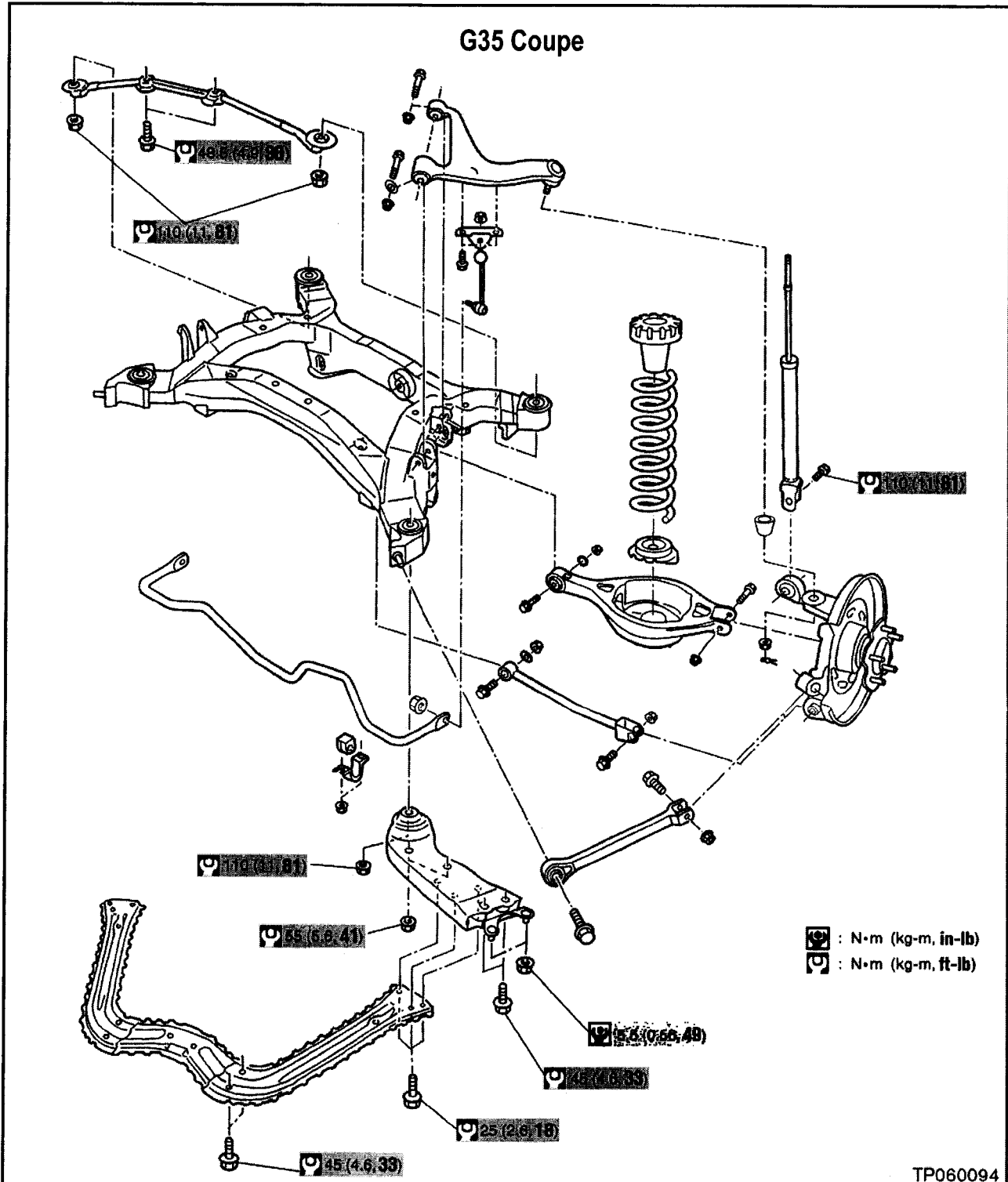

Figure 37

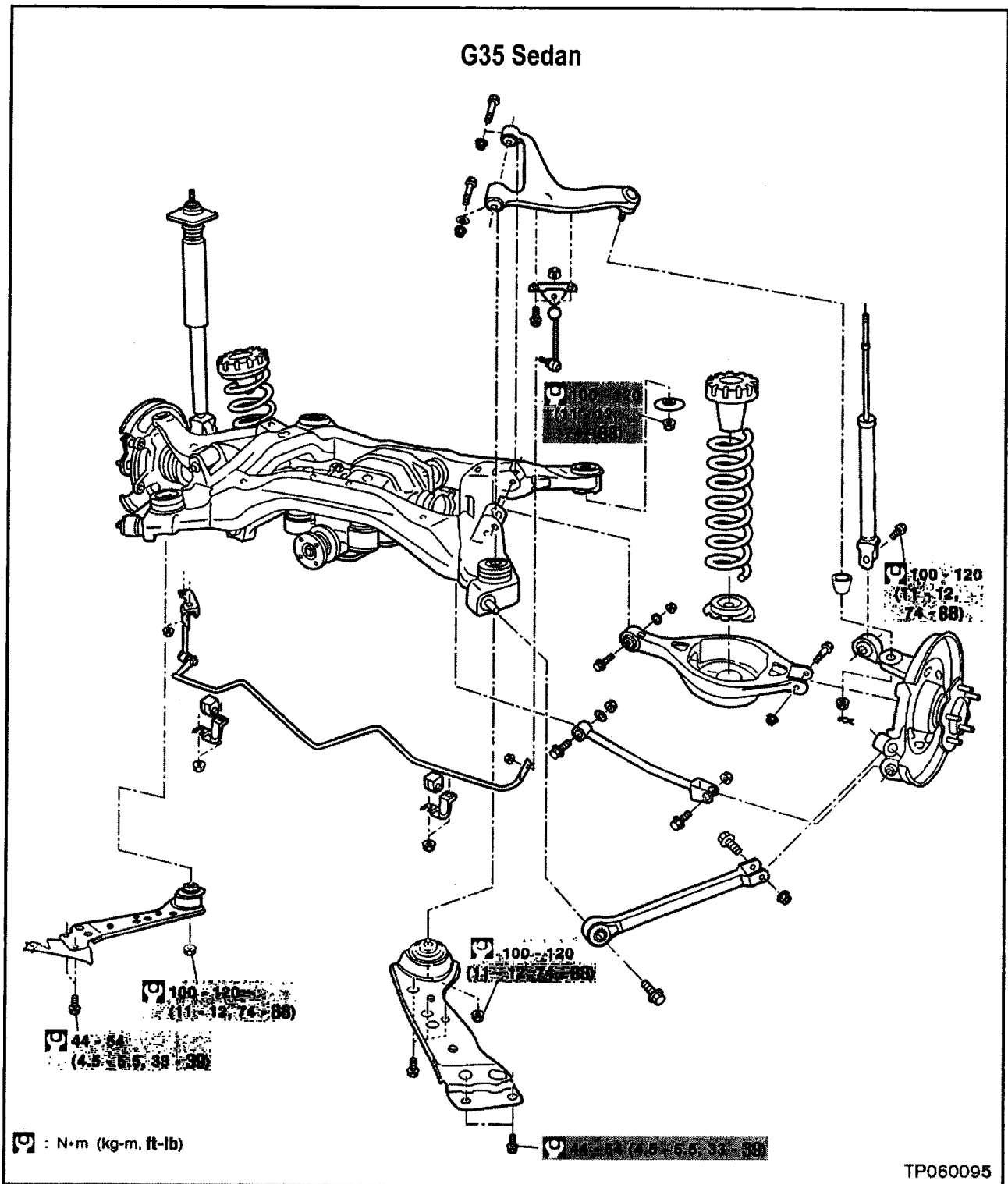

Figure 38

- Use new nuts/bolts (provided in the kit) for securing the propeller shaft to the differential pinion flange. Tighten the nuts to: 73.5 Nm (7.5 kg-m, **54 ft-lb**).
- Use a new gasket (see Parts Information) between the front and center exhaust tubes.

40. Re-connect the negative battery cable.

41. Re-program all radio station pre-sets.

SERVICE PROCEDURE (FX35 and FX45)

Remove the rear suspension member assembly and replace four fuel hoses (from the kit) as follows.

Preliminary Steps

1. Record all radio station presets.
2. Disconnect the negative battery cable.
3. Raise the vehicle on a hoist.

NOTE: Make sure the parking brake is released.

Remove Rear Wheels/Brake Calipers

4. Remove both rear wheels/tires.
5. Remove both brake calipers and hang them from the brake line supports with wire (see Figure 39).



Figure 39

Remove Center Exhaust Tube/Rear Muffler

6. Remove the exhaust system ground strap from the vehicle under body (see Figure 40).

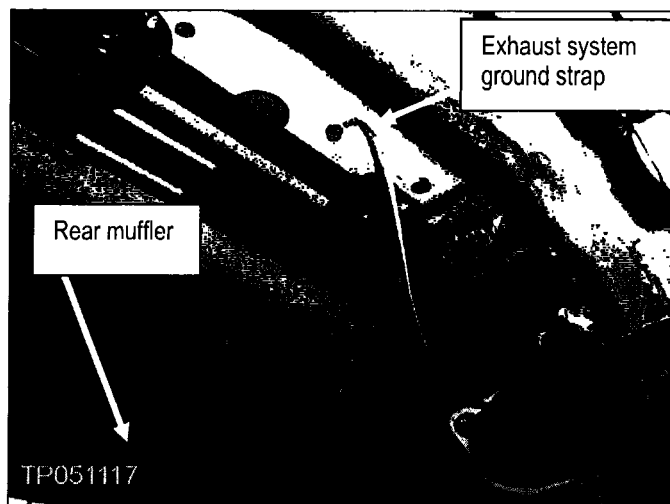

Figure 40

7. On the passenger (RH) side: release clips and remove the rear plastic under cover (see Figure 41).

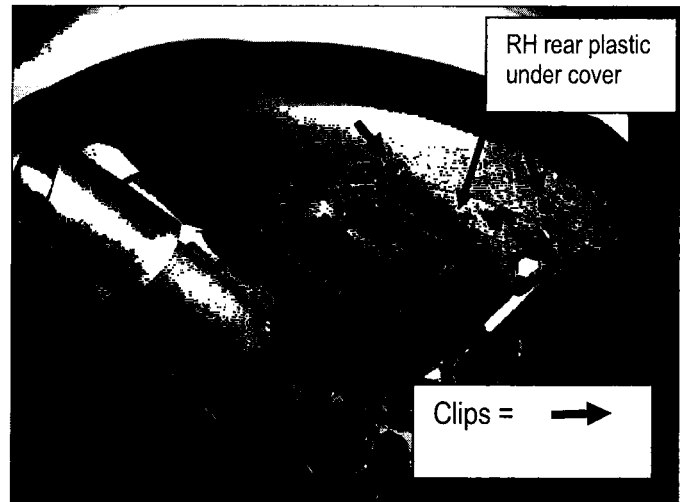

Figure 41

8. Below the plastic cover you just removed: release clips and remove the driver's (LH) side rear plastic under cover (see Figure 42).

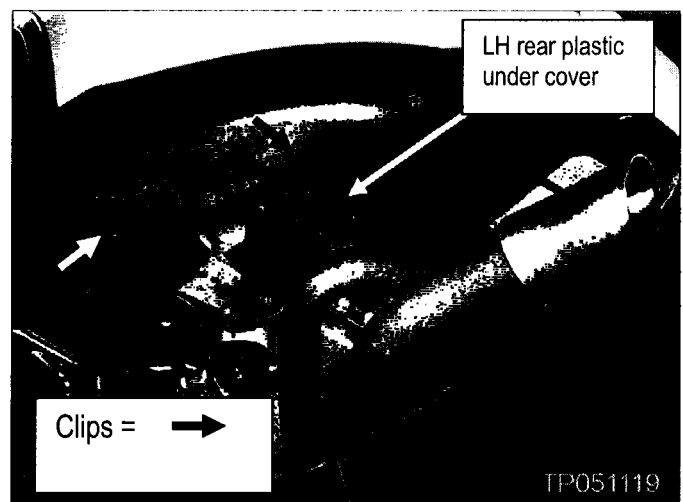

Figure 42

9. Remove the nut that holds the center muffler mount bracket (see Figure 43).

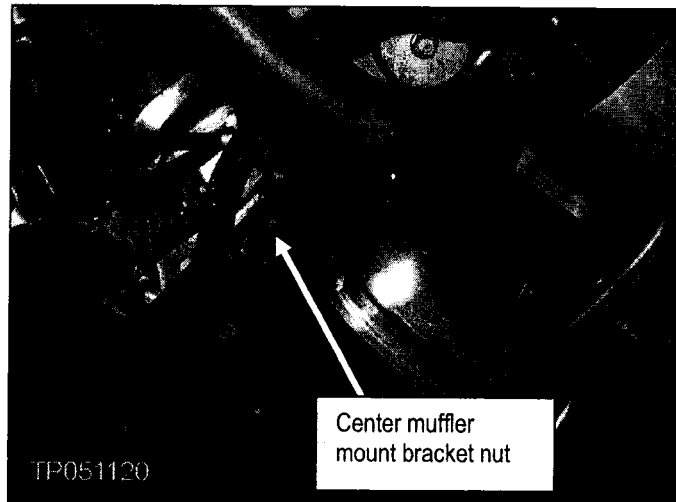

Figure 43

10. Remove nuts and bolts and remove the tunnel stay side covers and the tunnel "stay" (see Figure 44).

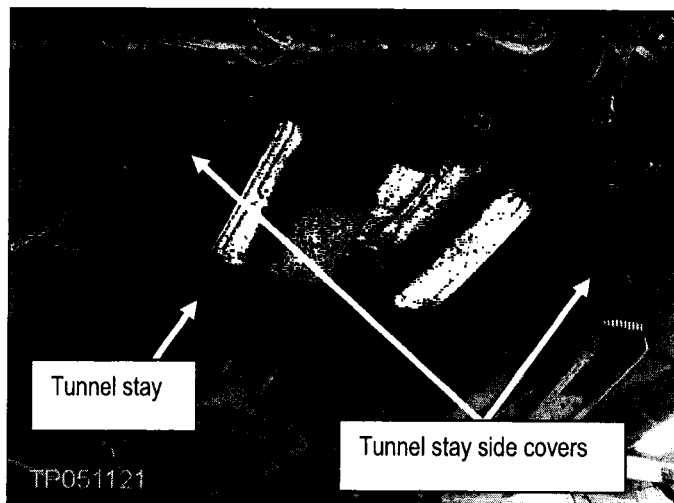

Figure 44

11. Remove and discard the exhaust system center tube front nuts (see Figure 45).

- You will install new nuts at re-assembly. See Parts Information for the nut part number.

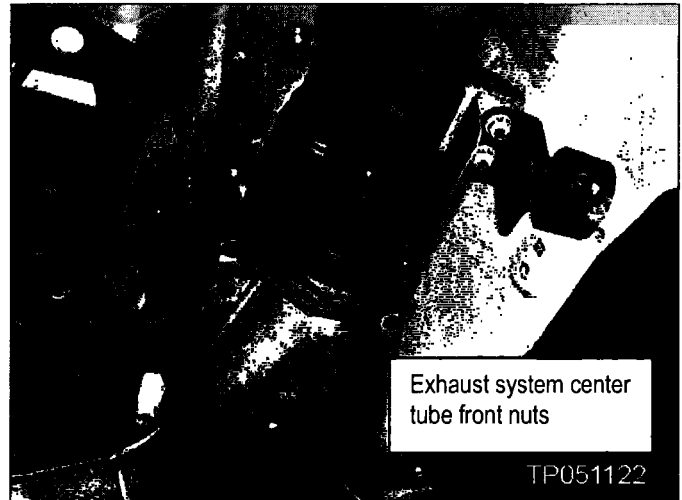

Figure 45

12. Support the exhaust system (see Figure 46).



Figure 46

13. Remove the rear muffler bracket bolts (see Figure 47a and 47b).

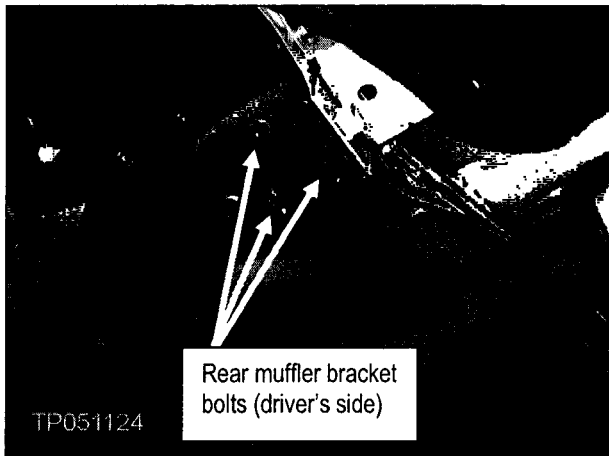

Figure 47a

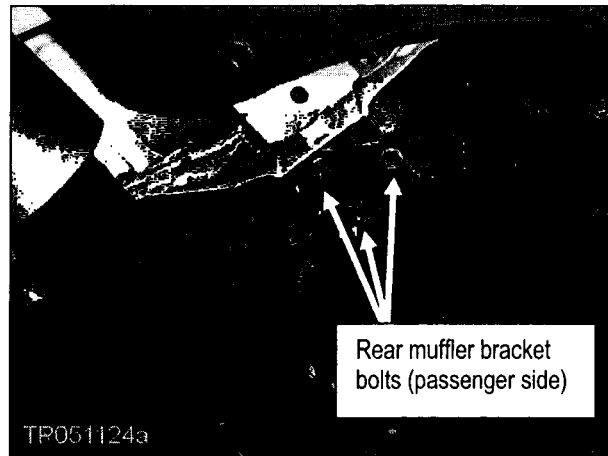

Figure 47b

NOTE: If the vehicle is equipped with a factory installed tow hitch, you must:

- Remove the passenger side muffler bracket
- Slide the driver's side rubber muffler hanger off of the muffler hanger pin

14. Remove the rear muffler rubber support bolt (see Figure 48).



Figure 48

15. Carefully remove the exhaust system and place it in a safe location (see Figure 49).



Figure 49

Disconnect Parking Brake Cables

16. Remove four nuts and remove the propeller shaft heat insulator (see Figure 50).

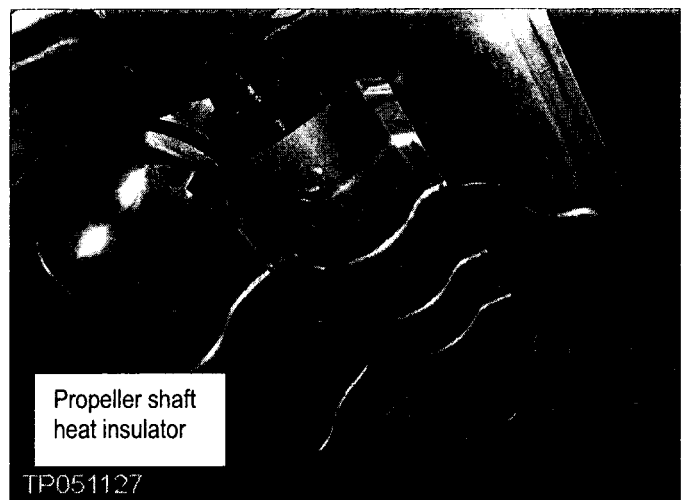

Figure 50

17. Apply an "index" (line up) mark across the propeller shaft and differential pinion flange for correct re-assembly (see Figure 51).

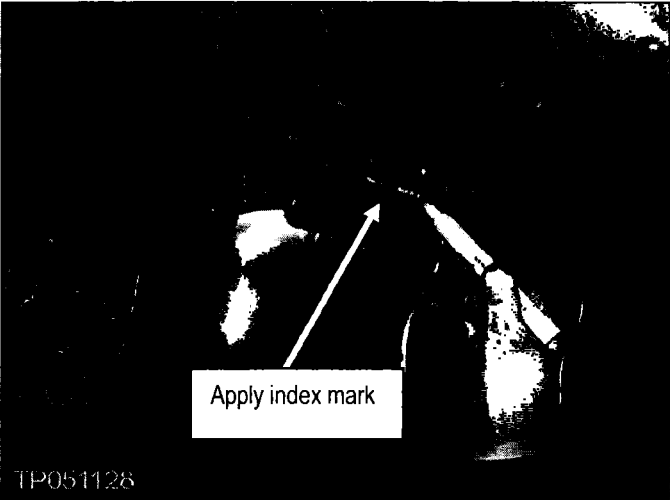

Figure 51

18. Remove the front and rear parking brake brackets (see Figure 52a and 52b).



Figure 52a



Figure 52b

19. Remove the parking brake cables from the front equalizer (see Figure 53).

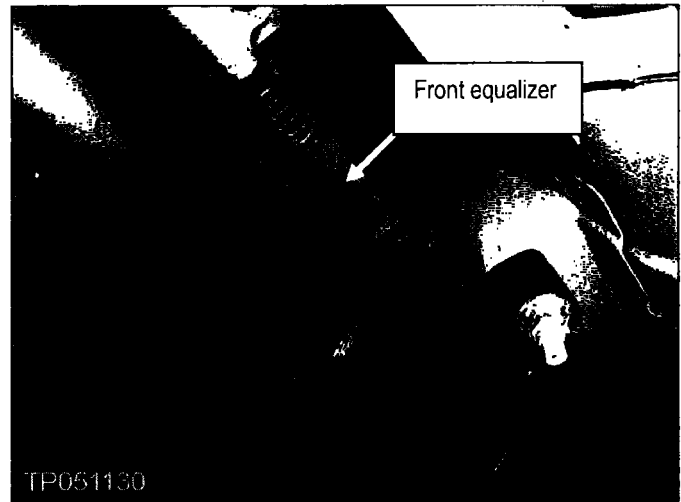

Figure 53

20. Remove the parking brake cables from the support clips (see Figure 54).



Figure 54

Re-Position Propeller Shaft

21. Remove and discard the propeller shaft nuts and bolts (see Figure 55).
 - You will install new nuts and bolts at re-assembly. See Parts Information for the bolt kit part number.

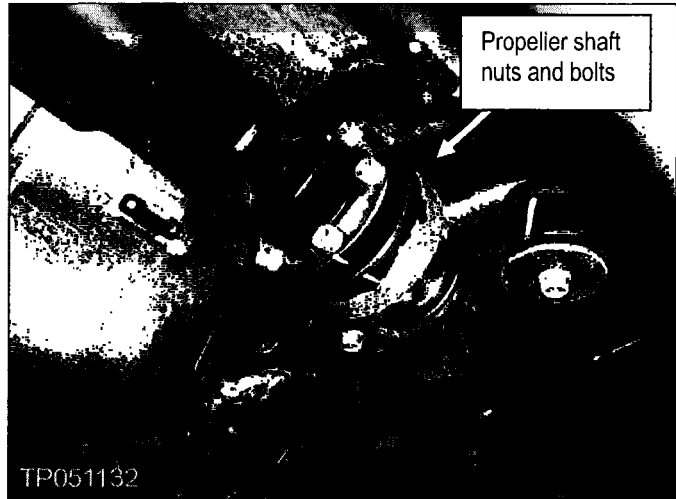

Figure 55

22. Position a support jack about six inches below the propeller shaft (see Figure 56). Then remove and discard the propeller shaft center bearing nuts and carefully lower the shaft onto the support jack.
 - You will install new nuts at re-assembly. See Parts Information for the nut part number.

CAUTION: Make sure to properly support the propeller shaft as it's being lowered.

- When you remove the center bearing nuts, the propeller shaft rear flange will drop away from the differential pinion flange.

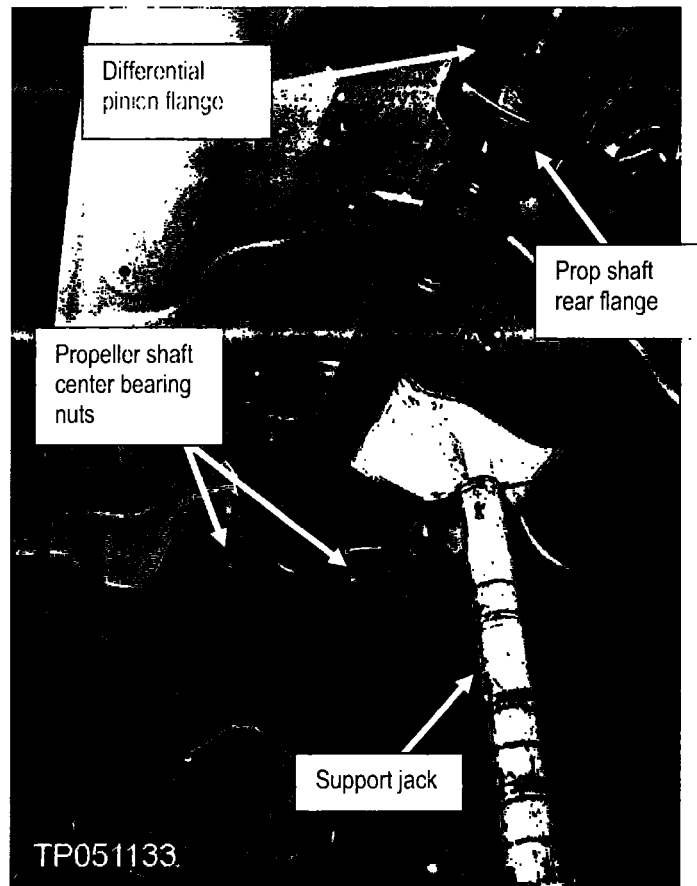

Figure 56

23. Use a piece of wire to hang the propeller shaft from one of the heat shield brackets (see Figure 57). Make sure the shaft is positioned to one side of the differential pinion flange.



Figure 57

Disconnect ABS Harness Connector/Remove Tie Wrap

24. Disconnect the ABS harness connector (see Figure 58a). Then remove the tie wrap from the suspension member using a pair of needle-nose pliers (see Figure 58b).
- If you accidentally break the tie wrap, install a new one at re-assembly. The tie wrap part number is 24225-89960.

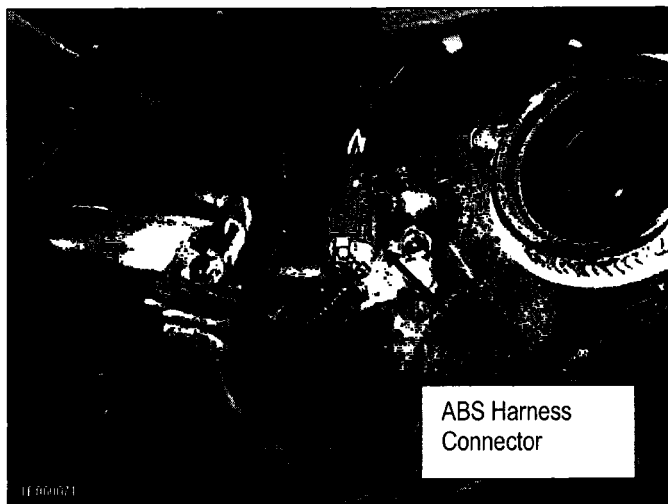

Figure 58a



Figure 58b

Disconnect Shock Absorber From Lower Link

25. Now place a support jack under the front lower link. Then disconnect the shock absorber from the link (see Figure 59).

IMPORTANT: DO NOT disconnect the shock absorber from the studs at the top of the wheel well housing (see Figure 60).



Figure 59

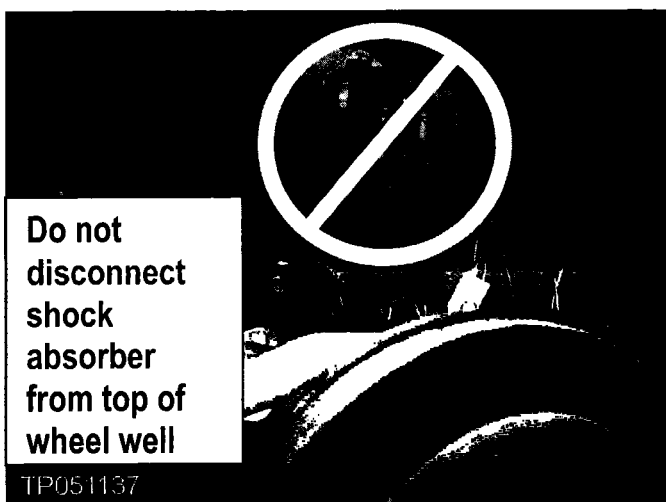

Figure 60

26. Place an index mark across the bushing and cross bar for proper re-assembly (see Figure 61).

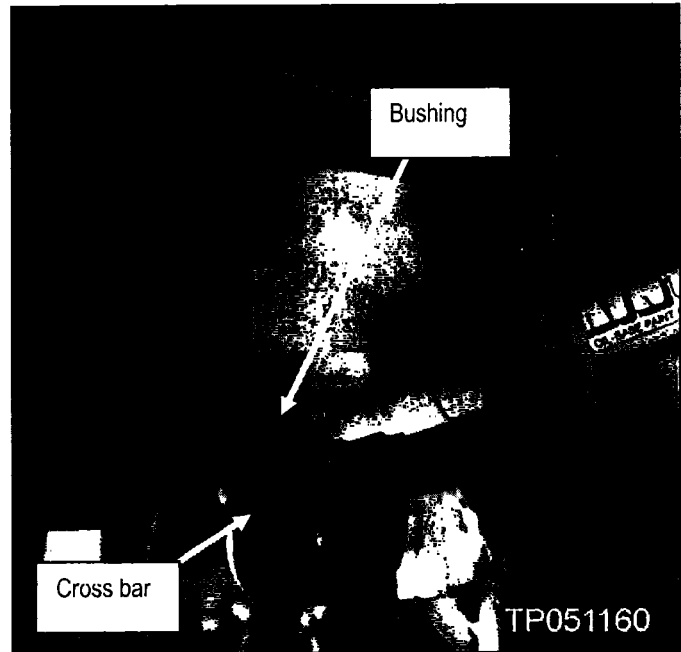

Figure 61

Install Jack Adapter Tool #J-47441-A To Differential

27. Install the jack adapter tool #J-47441-A to the differential pinion flange and suspension member as follows:

- a. Install part "A" of the adapter tool onto the pinion flange. Make sure both pins on the tool are inserted into the pinion flange bolt holes (see Figure 62).

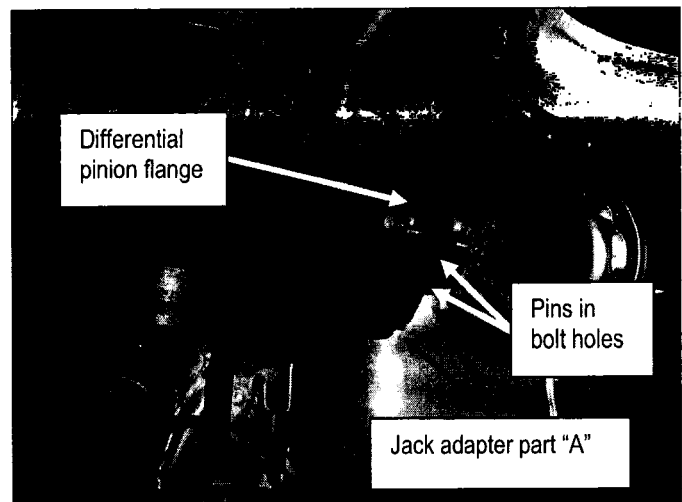

Figure 62

- b. Slide part "B" of the adapter tool over the rear of part "A". Then, insert the locator pins at the upper corners of the tool into the rear suspension member (see Figure 63).
- c. Install and tighten the bolt that holds "part A" to "part B" as shown in Figure 63.

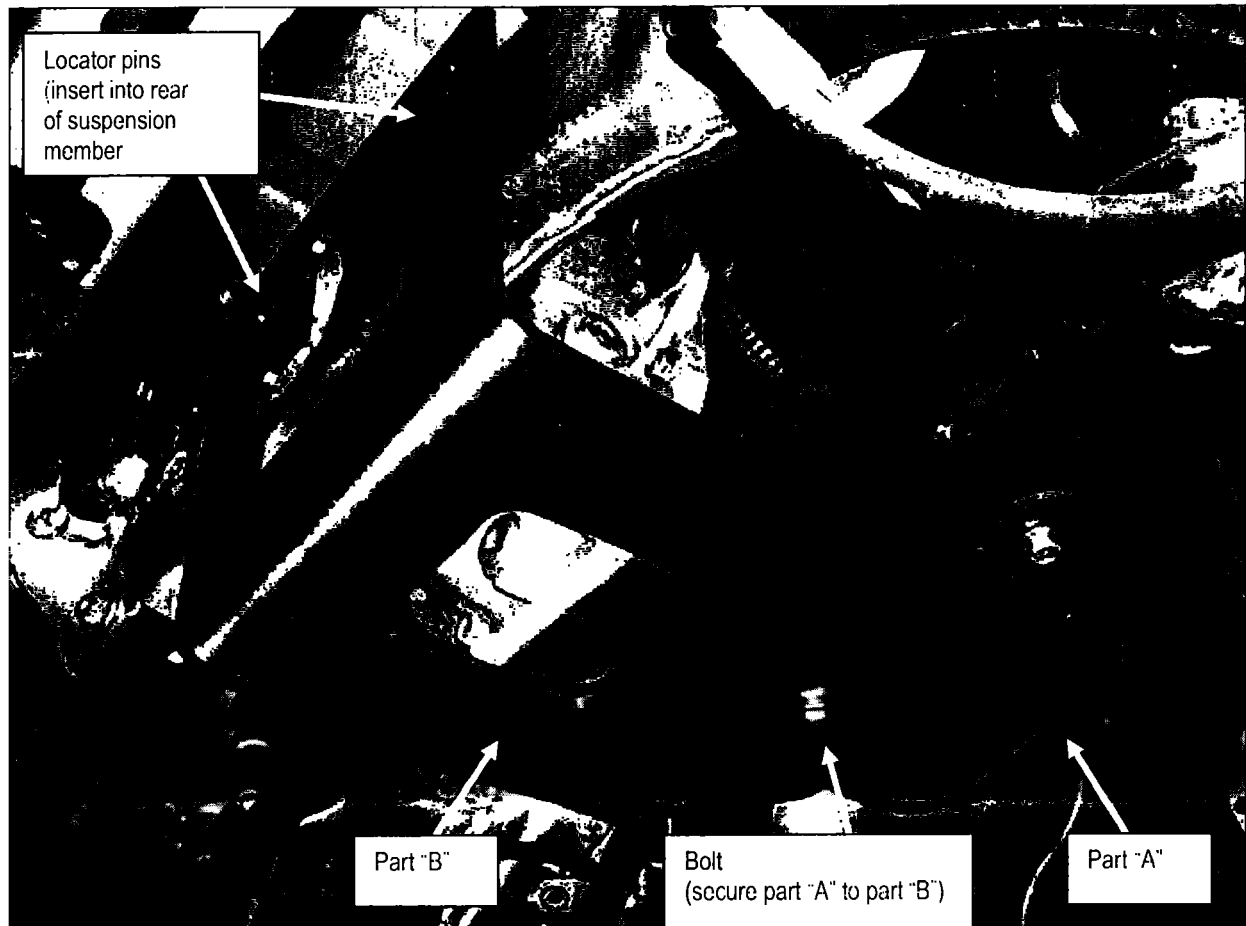

Figure 63

- d. Install jack adapter "part C" as shown in Figure 64.
- e. Install and tighten the bolt that holds "part C" to "part A" as shown in Figure 64.

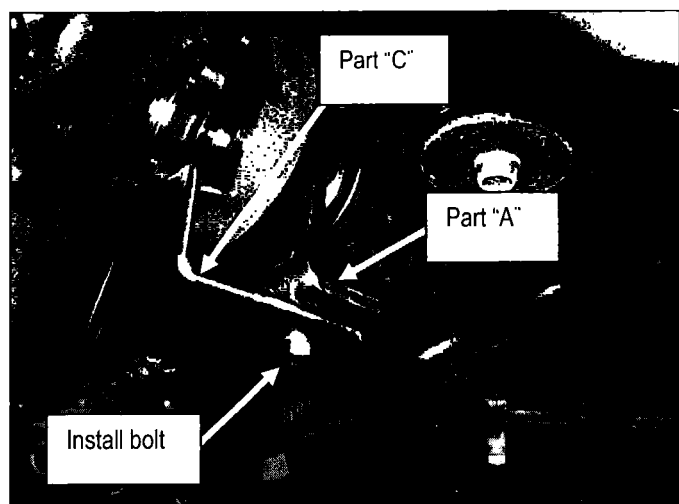

Figure 64

Remove Rear Suspension Member

28. Use bolts to install a transmission jack to the jack adapter as shown in Figure 65.

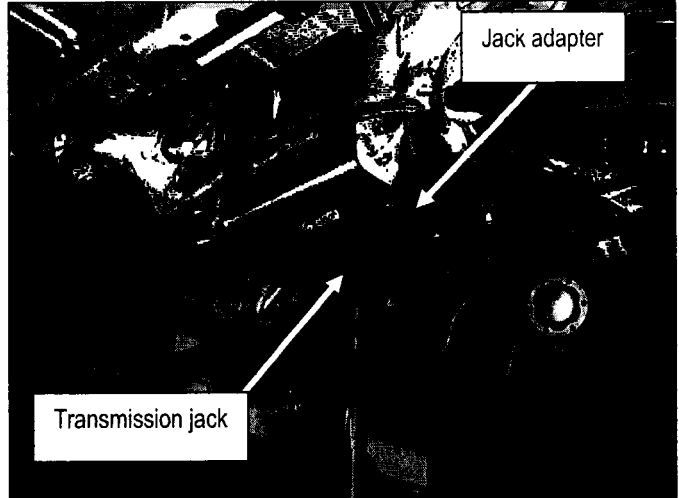

Figure 65

29. Place an additional support jack under the front suspension member to help stabilize the vehicle on the lift (see Figure 66).

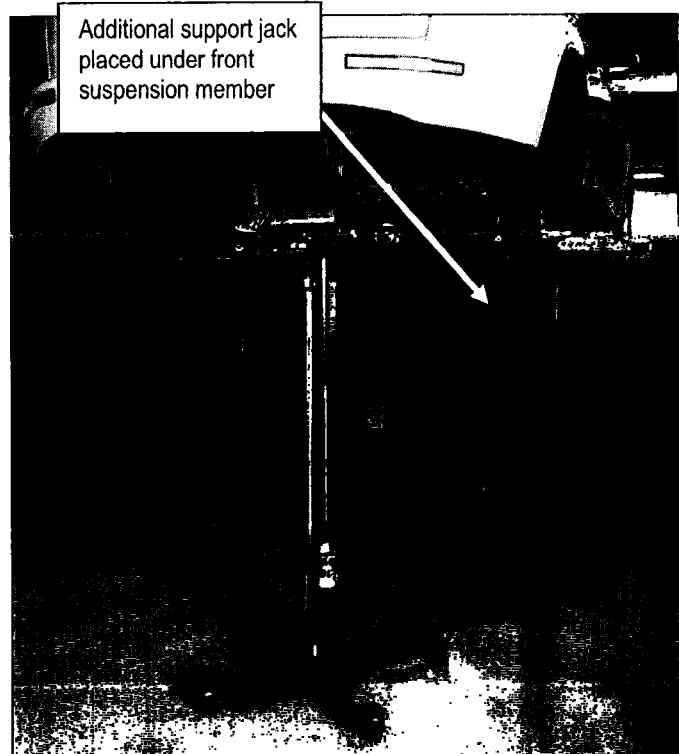

Figure 66

30. Remove the bolts and nuts that hold the suspension member "stay" brackets (both passenger and driver's side brackets). See Figure 67. Then remove the stay brackets.

NOTE: The larger nuts hold the suspension member.

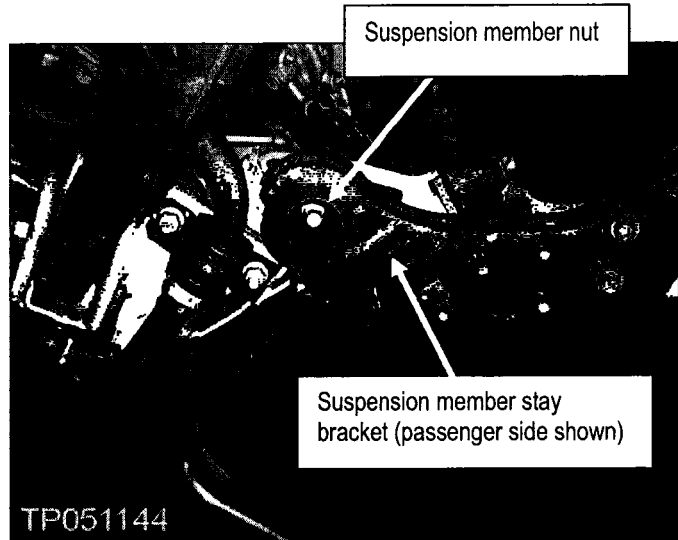

Figure 67

31. Remove the rear stay bracket and suspension member rear nuts (see Figure 68).

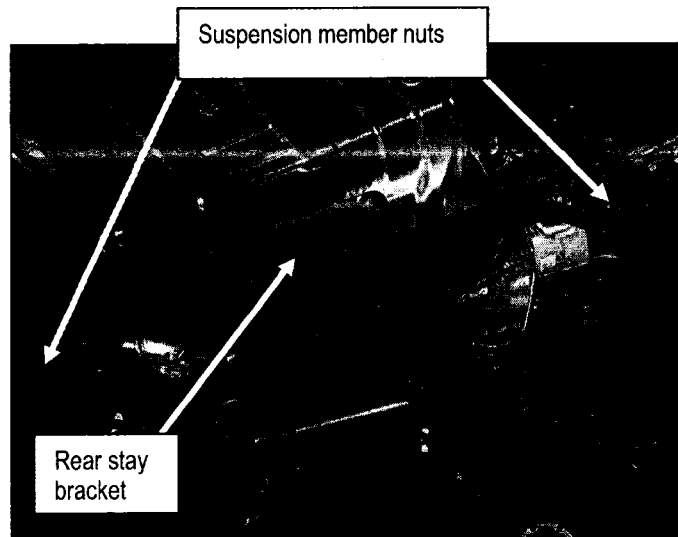

Figure 68

32. Carefully lower the suspension member out of the vehicle (see Figure 69) and place it in a safe location.

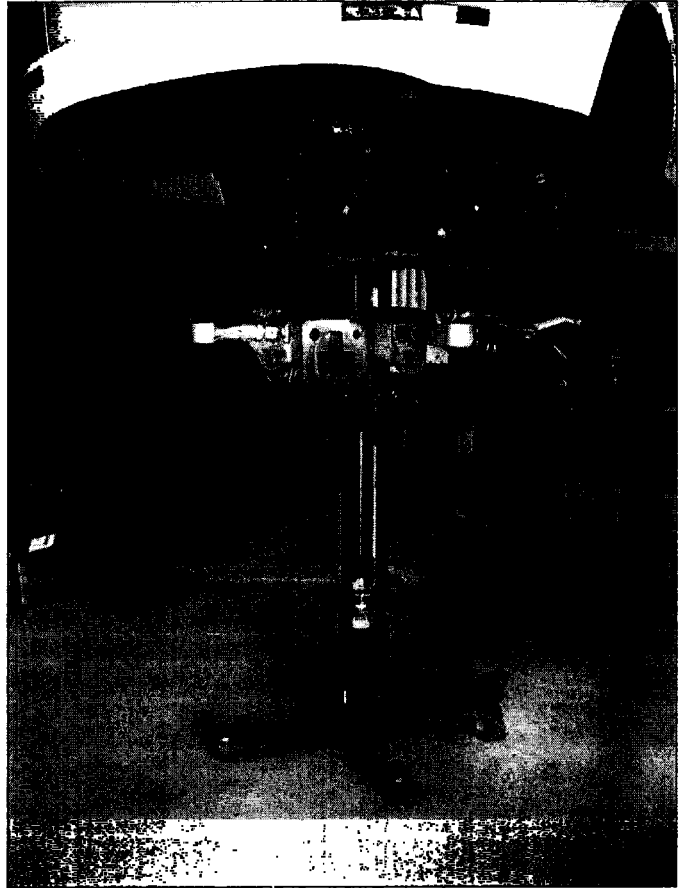

Figure 69

Install Fuel Hoses

CAUTION: Make sure the fuel tank is less than 1/4 full before you perform this procedure.

33. Remove three nuts and remove the evaporative canister shield (see Figure 70).

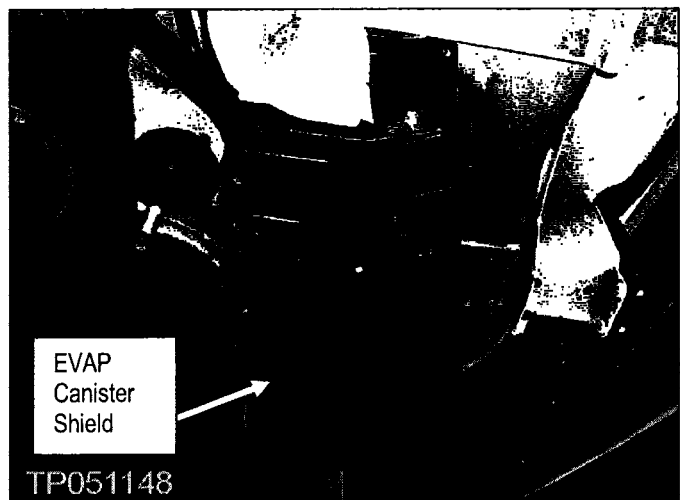

Figure 70

34. Remove and replace the four fuel hoses (provided in the kit). See Figure 71.

- Replace hoses one at a time, making sure they are correctly positioned and secured.
- Tighten the fuel filler hose clamps so that the distance between the bolt head and metal plate is set to the proper dimension (see Figure 71).

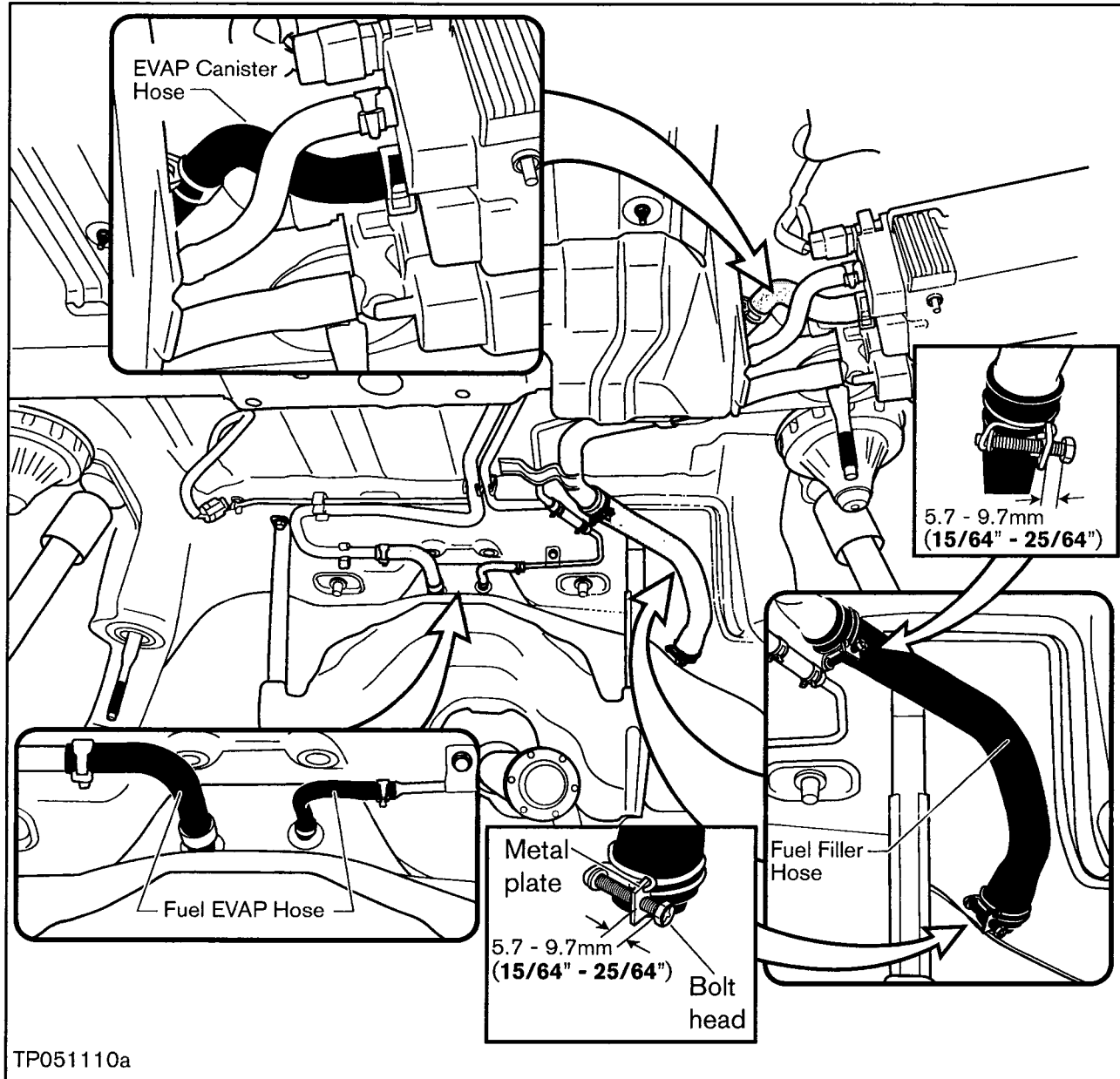

Figure 71

Re-Assembly

35. Re-install all components in the reverse order of removal, making sure of the following:

- All highlighted suspension fasteners are tightened to the proper torque specification (see Figure 72).
- All "index" marks that you made earlier are lined up.

FX35 / FX45

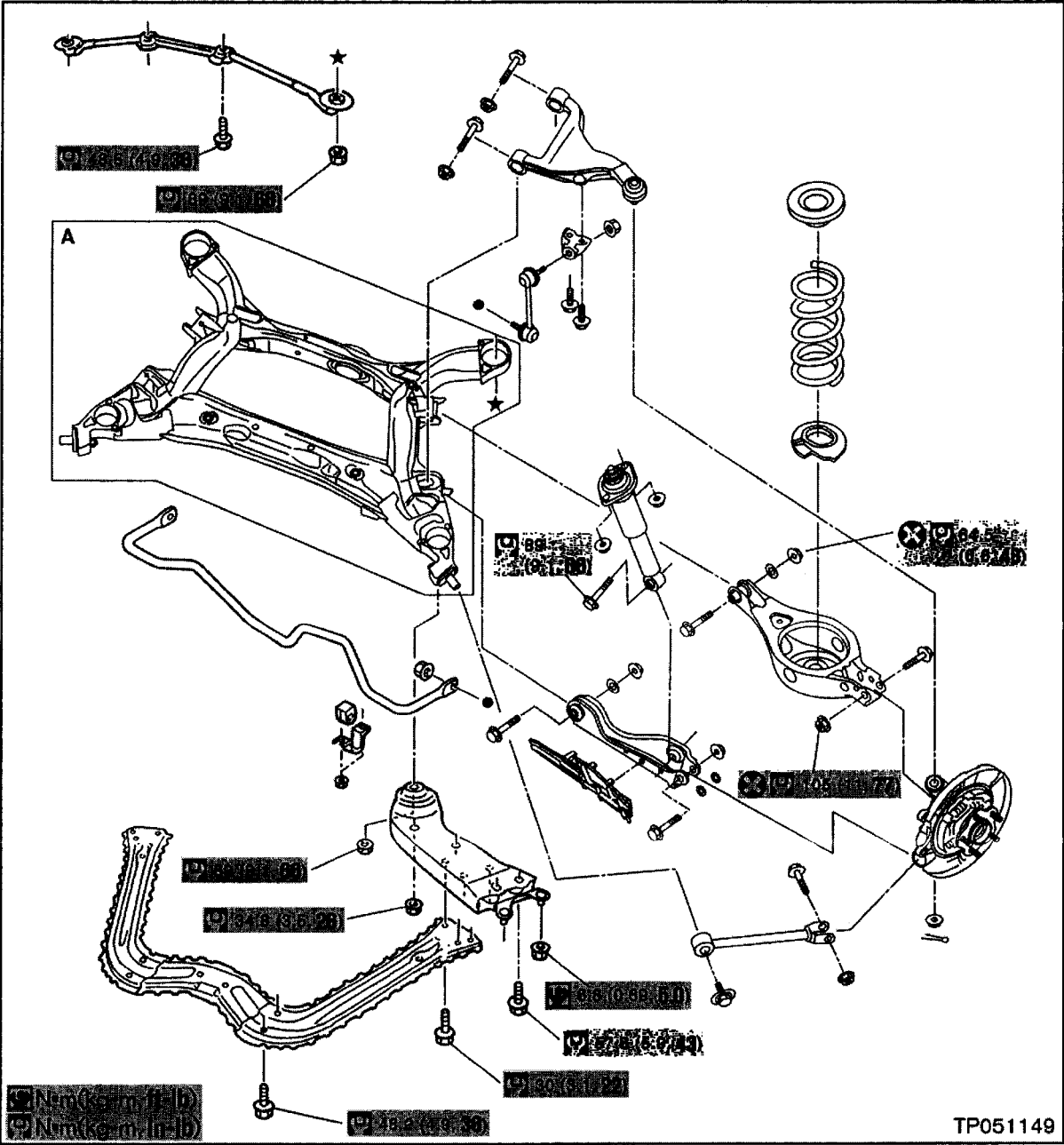

Figure 72

- Use new nuts/bolts (provided in the kit) for securing the propeller shaft to the differential pinion flange. Tighten the nuts to: 56.9 Nm (5.8 kg-m, **42 ft-lb**).
- Use new nuts (see Parts Information) for mounting the propeller shaft center bearing assembly. Tighten these nuts/bolts to: 44 Nm (4.5 kg-m, **70 ft-lb**).
- Use a new gasket (see Parts Information) between the front and center exhaust tubes. Also, use new nuts (see Parts Information) for securing these tubes together.

36. Re-connect the negative battery cable.

37. Re-program all radio station pre-sets.

PARTS INFORMATION

DESCRIPTION	MODEL	PART NUMBER	QTY	
Fuel Hose Kit	G35 Coupe	A7226-CD01A	1	
	G35 Sedan	A7226-AM63A	1	
	FX35 / FX45	A7226-CG00A	1	
Propeller Shaft Bolt Kit	G35 Coupe	37120-AL625	1	
	G35 Sedan	37120-AL625	1	
	FX45 (AWD)	37120-AR525 (All 2003 MY and 2004 MY up to VIN # W*4X400800)	1	
		37120-CG225 (After VIN # W*4X400801)	1	
	FX35 (2WD)	37120-AR525 (All 2003 MY and 2004 MY up to VIN # U*4X101328)	1	
		37120-CG225 (After VIN # U*4X101329)	1	
	FX35 (AWD)	37120-AR525 (All 2003 MY and 2004 MY up to VIN # W*4X203795)	1	
		37120-CG225 (After VIN # W*4X203796)	1	
	Nuts – Propeller Shaft Center Bearing	FX35 / FX45	01225-00062	2
	Nuts – Exhaust Tube	FX35 / FX45	20602-41G00	2
Gasket – Exhaust Tube	All Models	20692-65J00	1	

CLAIMS INFORMATION

Submit a Campaign (CM) line claim using the following claims coding:

"CM" I.D.: R0508

For G35 Sedan:

DESCRIPTION	OP CODE	FRT
RPL Fuel Vapor Hose	R05080	1.9 hrs

OR:

For G35 Coupe:

DESCRIPTION	OP CODE	FRT
RPL Fuel Vapor Hose	R05081	2.1 hrs

OR:

For FX35/45:

DESCRIPTION	OP CODE	FRT
RPL Fuel Vapor Hose	R05082	2.3 hrs

OWNER'S LETTER

Dear Infiniti Owner:

This notice is sent to you in accordance with the requirements of the National Traffic and Motor Vehicle Safety Act. Nissan Motor Company, Ltd. has decided that a defect that relates to motor vehicle safety exists in some 2003-2006 model year Infiniti vehicles.

Reason for Recall

The fuel filler hose may crack and result in fuel leakage from the hose while refueling. If an ignition source is present, a fire could occur. In addition, fuel vapor hoses may crack and cause the malfunction indicator lamp to come on.

What Infiniti Will Do

Your Infiniti dealer will replace the fuel filler and vapor hoses with new ones. This free service should take about three hours to complete, but your Infiniti dealer may require your vehicle for a longer period of time based upon their work schedule.

What You Should Do

Contact your Infiniti dealer at your earliest convenience in order to arrange an appointment to have your vehicle repaired. Please bring this notice with you when you keep your service appointment. **It will be necessary that your fuel tank be no more than one-quarter full when you bring your vehicle to the dealer in order to minimize the possibility of fuel spill during the repair.** Instructions have been sent to your Infiniti dealer. If the dealer fails, or is unable to make the necessary repairs free of charge, you may contact an Infiniti representative toll free at (800) 662-6200.

If you have paid to have your fuel filler or vapor hoses replaced prior to this campaign, you may be eligible for reimbursement of the related expense. You may also submit a complaint to the Administrator, National Highway Traffic Safety Administration, 400 Seventh Street, SW., Washington, DC 20590; or call the toll-free Vehicle Safety Hotline at 1-888-327-4236 (TTY: 1-800-424-9153); or go to <http://www.safercar.gov>.

Federal law requires that any vehicle lessor receiving this recall notice must forward a copy of this notice to the lessee within ten days.

Thank you for your cooperation. We are indeed sorry for any inconvenience this may cause you.

