

RECEIVED

2004 OCT 15 A 9 29

04V-413

DEFECT REPORTS
SECTION

G-04514
October 2004

**SUBJECT: SAFETY RECALL (U.S., EXPORT)
PARK BRAKE ASSEMBLY on certain 3200, 4200,
4300, 4400 and CE School Bus models built
7/20/2004 thru 8/5/2004 with Hydraulic Brakes.**

DEFECT DESCRIPTION

The park brake assembly was manufactured incorrectly, possibly causing it to not fully engage or release. If the park brake does not fully engage, the vehicle may not remain stationary when parked or if the park brake does not fully release, the brake may drag. A vehicle roll-away or dragging park brake may result in property damage, personal injury or death.

MODELS INVOLVED

This Safety Recall involves International 3200, 4200, 4300 and 4400 models with hydraulic brakes built 7/20/2004 thru 8/3/2004 at the Springfield, Ohio Assembly Plant and CE School Bus models with hydraulic brakes built 7/23/2004 thru 8/5/2004 at the Conway, Arkansas Assembly Plant with hydraulic brakes.

OWNER NOTIFICATION

International Truck and Engine Corporation will notify owners of these vehicles about this campaign. A copy of the owner letter is attached. During the recall process, a listing of owner names and addresses will be furnished to the involved dealers to enable dealers to follow up with owners and have the vehicles corrected. You must limit the use of this listing to this campaign because the list may contain information obtained from state motor vehicle registration records and the use of such motor vehicle registration data for purposes other than this campaign is a violation of law in several states.

PARTS INFORMATION

The part required for this recall is:

Part Number	Part Description	Quantity
3575655C92	BRAKE, DLM*BRAKE ASSY 12 X 3 DS	1
As Per Lineset Ticket	PINION OIL SEAL	1
As Per Lineset Ticket	U-Joint Straps and Bolts	1

Only about 60 vehicles (15%) of the total suspect population are expected to require a replacement park brake. Please order parts accordingly.

Destroy and discard all removed parts locally.

SERVICE PROCEDURE



WARNING:

TO PREVENT SERIOUS EYE INJURY, ALWAYS WEAR SAFE EYE PROTECTION WHEN YOU PERFORM VEHICLE MAINTENANCE OR SERVICE.



WARNING:

TO PREVENT UNEXPECTED MOVEMENT OF THE VEHICLE AND POSSIBLE SERIOUS PERSONAL INJURY OR DEATH, BLOCK THE WHEELS TO PREVENT THE VEHICLE FROM MOVING IN BOTH DIRECTIONS.

PARK BRAKE TEST PROCEDURE

1. All vehicles must undergo the following test to determine if replacement of the park brake assembly is required.



WARNING:

TO PREVENT UNEXPECTED MOVEMENT OF THE VEHICLE AND POSSIBLE SERIOUS PERSONAL INJURY OR DEATH, PERFORM THE FOLLOWING TEST PROCEDURE IN AN OPEN AREA WITH NOTHING BLOCKING THE FORWARD MOVEMENT OF VEHICLE, I.E. WALL, OTHER VEHICLE, OTHER PERSONNEL, ETC.

2. Ensure vehicle is in an open area. See WARNING above.
3. Set park brake.
4. Using an infrared temperature gun or suitable electronic temperature recording device, record the temperature of the outside surface of the park brake drum. Save recorded temperature for comparison in steps 13 or 21.
 - a. The park brake drum surface temperature must be within +/- 10% of the ambient air temperature before the rest of the test can be completed.

FOR MANUAL TRANSMISSIONS

5. Place vehicle in second (2nd) gear.
6. Depress accelerator and rev engine to 800 rpm.
7. Slowly release clutch.
8. If vehicle pulls away, **REPLACE PARK BRAKE ASSEMBLY**. See **PARK BRAKE ASSEMBLY REPLACEMENT PROCEDURE** below.
9. If vehicle does not pull away, depress clutch, place vehicle in first (1st) gear and let the engine return to proper idle speed.
10. Depress brake pedal.
11. Release park brake and drive vehicle for about 1 mile or 2 km at between 30-40 mph (48-64 kph).

12. Upon return from drive. Stop vehicle, apply parking brake, turn engine off.
13. Record temperature of park brake drum outer surface.
 - a. If surface temperature has risen more than 50° Fahrenheit (10° Celsius) or if park brake temperature exceeds 150° Fahrenheit (65.5° Celsius), REPLACE PARK BRAKE ASSEMBLY. See *PARK BRAKE ASSEMBLY REPLACEMENT PROCEDURE* below.
 - b. Otherwise, if temperature rise is minimal, the park brake does NOT require replacement.

FOR AUTOMATIC TRANSMISSIONS

14. Place vehicle into DRIVE or first (1st) gear.
15. Depress accelerator and rev engine to 1500 rpm.
16. If vehicle pulls away, REPLACE PARK BRAKE ASSEMBLY. See *PARK BRAKE ASSEMBLY REPLACEMENT PROCEDURE* below.
17. If vehicle does not pull away, let the engine return to proper idle speed.
18. Depress brake pedal.
19. Release park brake and drive vehicle for about 1 mile or 2 km at between 30-40 mph (48-64 kph).
20. Upon return from drive. Stop vehicle, apply parking brake, turn engine off.
21. Record temperature of park brake drum outer surface.
 - a. If surface temperature has risen more than 50° Fahrenheit (10° Celsius) or if park brake temperature exceeds 150° Fahrenheit (65.5° Celsius), REPLACE PARK BRAKE ASSEMBLY. See *PARK BRAKE ASSEMBLY REPLACEMENT PROCEDURE* below.
22. Otherwise, if temperature rise is minimal, the park brake does NOT require replacement.

PARK BRAKE ASSEMBLY REPLACEMENT PROCEDURE

1. Disconnect driveshaft at rear axle.
2. Remove park brake drum bolts and park brake drum.



Figure 1

3. Remove flange nut and flange. A puller may be required.
4. Disconnect park brake cable.

5. Remove four (4) park brake assembly bolts, two (2) on each side.

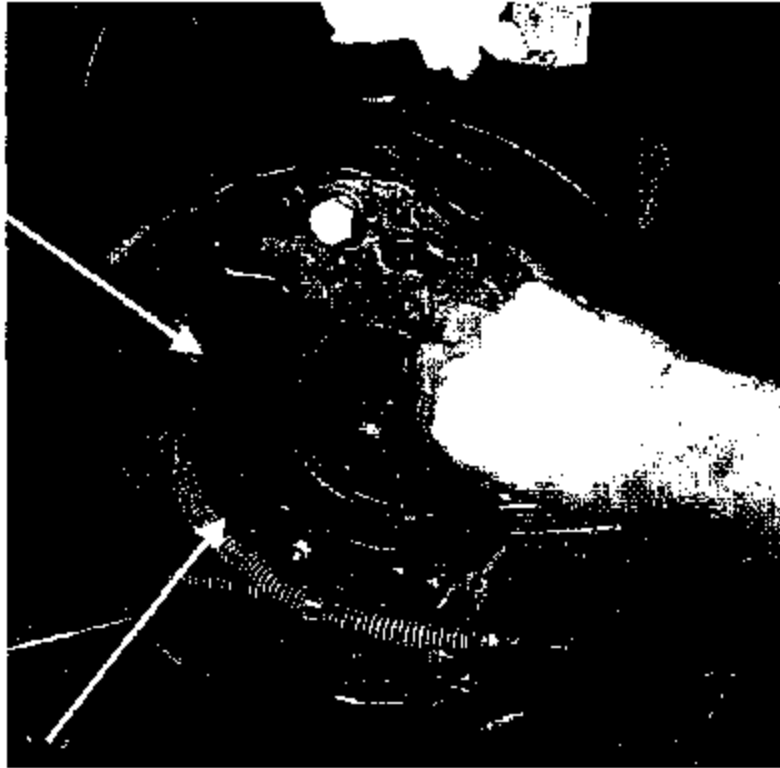

Figure 2

6. Remove park brake assembly.

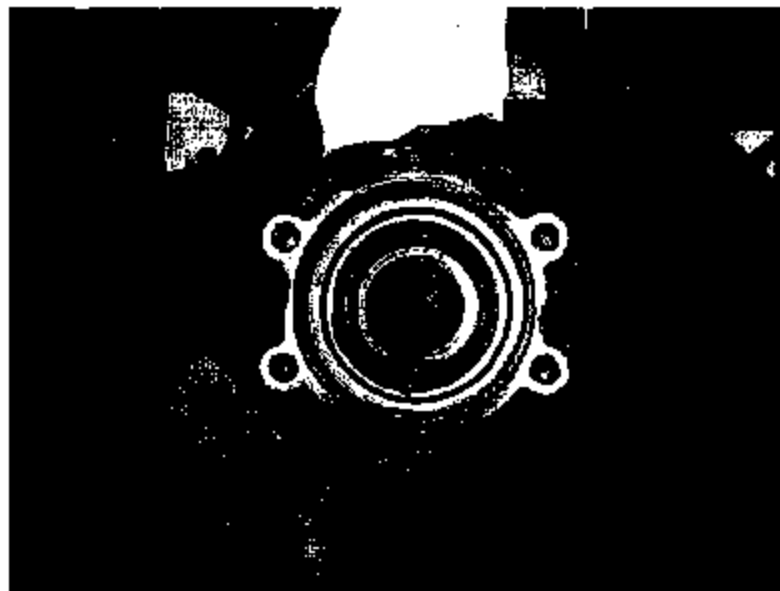

Figure 3

7. Remove pinion oil seal.
8. Install a new pinion oil seal.
9. Install a new park brake assembly.

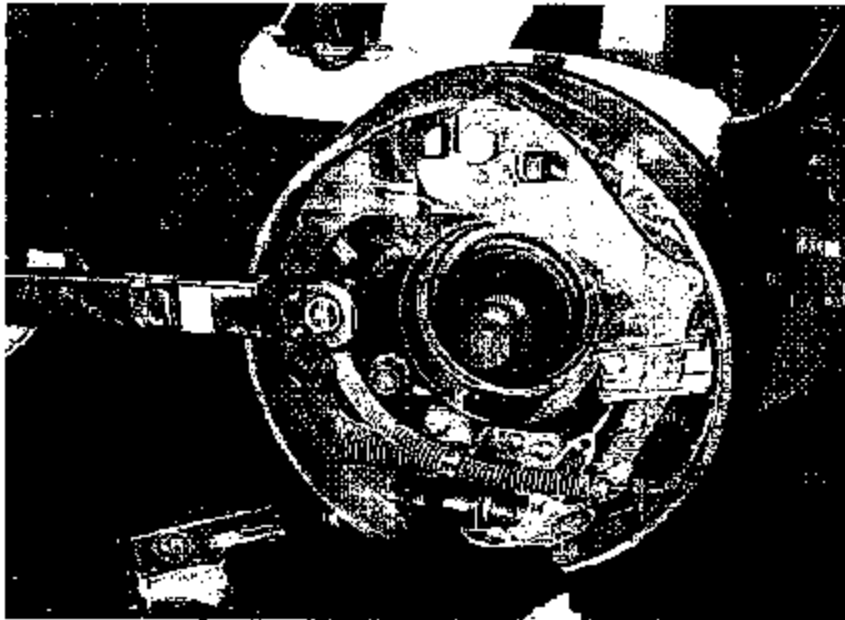

Figure 4

10. Torque bolts in the following pattern to 220-240 LbF-Ft (294-325Nm).

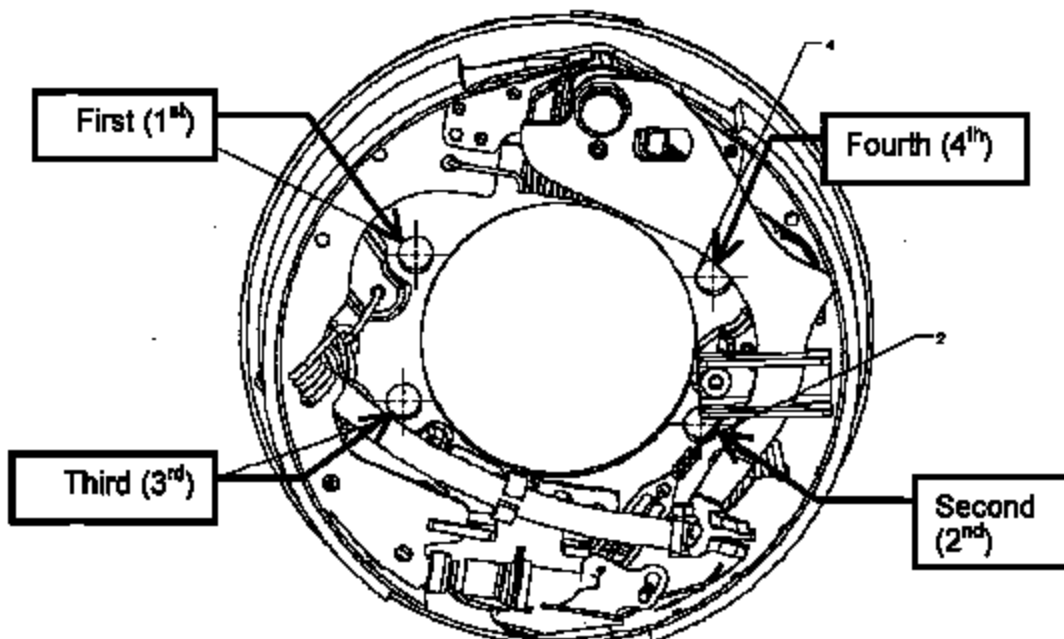

Figure 5

11. Reconnect park brake cable.
12. Install flange. Torque flange nut to axle manufacturer's specifications. Refer to Lineset Ticket and Master Service Manual for Torque Charts.

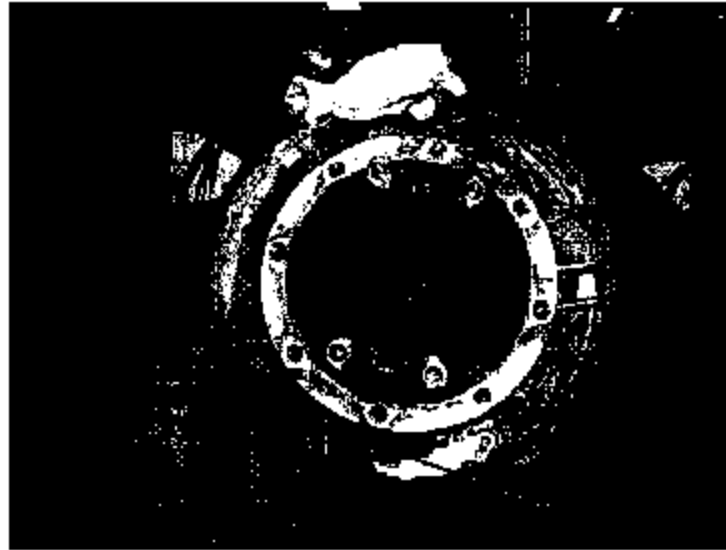

Figure 6

13. Re-install park brake drum.
14. Torque bolts in the following pattern to 41- 47 LbF-Ft (58-63Nm).

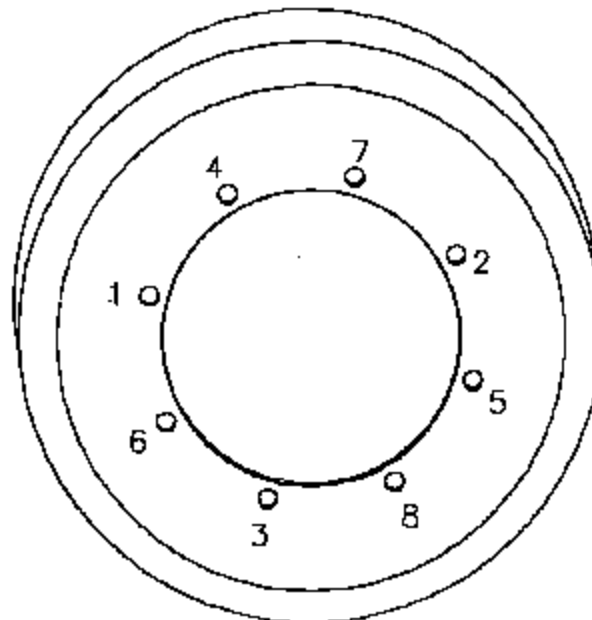

Figure 7

15. Re-attach drive shaft with new straps and bolts. Torque strap bolts to drive shaft manufacturer's specifications. Refer to Lineset Ticket and Master Service Manual for Torque Charts.



Figure 8

16. Check rear axle oil level and re-fill if necessary.
17. Check park brake cable tension and adjust if necessary as per Master Service Manual.

END OF SERVICE PROCEDURE

LABOR INFORMATION

<u>Operation No.</u>	<u>Description</u>	<u>Time</u>
A40-04514-1	Perform Vehicle Test, NO Park Brake Assembly Replacement	0.7 Hr
A40-04514-2	Perform Vehicle Test AND Replace Park Brake Assembly	1.7 Hr

CAMPAIGN IDENTIFICATION LABEL

Each vehicle corrected in accordance with this campaign must be marked with a CTS-1075 Campaign Identification Label.

Complete the label and attach on a clean surface next to the vehicle identification number (VIN) plate.



DO NOT REMOVE

INFORMATIONAL

Campaign No.

VIN
Exp. #

COMPLETED

Service Location Code #

DO NOT REMOVE

ADMINISTRATIVE/DEALER RESPONSIBILITIES (U.S. & POSSESSIONS)

Proceed immediately to make necessary correction to units in inventory. **All inventory vehicles subject to this recall campaign must be corrected prior to sale, transfer or delivery.** If vehicles have been sold or transferred and you are in receipt of Customer Notification Letters and Authorization for Recall Service cards for those vehicles, the transfer location or customer must be notified **IMMEDIATELY** from your dealer location.

Dealers must correct all vehicles subject to this campaign at no charge to the owner, regardless of mileage, age of vehicle, or ownership, from this time forward.

The National Traffic and Motor Vehicle Safety Act, as amended, provides that each vehicle that is subject to a vehicle recall campaign must be adequately **repaired** within a reasonable time after the owner has tendered it for repair. A failure to adequately repair within **60 days** after a tender of a vehicle is prima facie evidence of failure to repair within a reasonable time. If the condition is not adequately repaired within 60 days, the owner may be entitled to replacement with an identical or reasonable equivalent vehicle at no charge, or to a refund of the purchase price less a reasonable allowance for depreciation.

However, consistent with the customer notification, dealers are expected to complete the repairs on the mutually agreed upon service date.

To avoid having to replace an owner vehicle or refund the purchase price, every effort must be made to promptly schedule an appointment with each owner to repair his or her vehicle as soon as possible.

WARRANTY CLAIMS

Refer to Dealer Warranty Manual for procedures to conduct Recall Campaigns.

It is important that the Recall Coding be completed properly to assist in processing the warranty claim. Complete instructions will be found in the Warranty Manual, Section 7-1. Special attention should be given to Items 39 through 44:

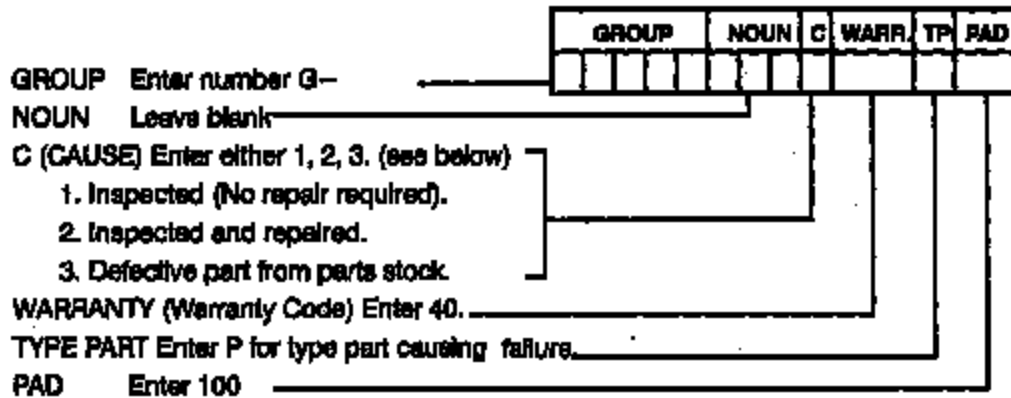

ADMINISTRATIVE/DISTRIBUTOR RESPONSIBILITY (EXPORT)

Proceed immediately to make necessary correction to units in inventory. All inventory vehicles subject to this recall campaign must be corrected prior to sale, transfer or delivery. If vehicles have been sold or transferred and you are in receipt of Customer Notification Letters and Authorization for Recall Service cards for those vehicles, the transfer location or customer must be notified from your distributor location.

Export locations are to submit warranty claims in the usual manner making reference to this recall number.

We ask for your full cooperation and follow-up to this important subject matter. If you have any questions or need further assistance, please contact the Regional Service Manager at your regional office.

INTERNATIONAL TRUCK AND ENGINE CORPORATION