

Display CARFAX in online listings:

CARFAX History-Based Value Report

\$65,960
CARFAX Retail Value

History events affecting this vehicle's value

- 1-Owner Vehicle
- Regular Oil Changes
- Personal Vehicle
- Accident Reported



Vehicle History Report™

US \$44.99

2022 CADILLAC
ESCALADE PREMIUM
LUXURY

VIN [REDACTED]
4 DOOR WAGON/SPORT
UTILITY
6.2L V8
GASOLINE
REAR WHEEL DRIVE W/ 4X4
Original Window Sticker

This CARFAX Report Provided
by:
ESIS GM

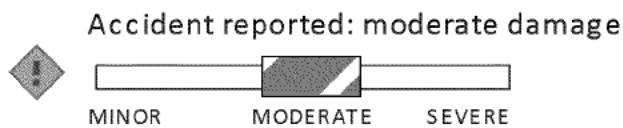

Regular oil changes

CARFAX 1-Owner vehicle

Personal lease vehicle

35,150 Last reported odometer reading



This CARFAX Vehicle History Report is based only on information supplied to CARFAX and available as of 3/14/25 at 1:45:56 PM (CDT). Other information about this vehicle, including problems, may not have been reported to CARFAX. Use this report as one important tool, along with a vehicle inspection and test drive, to make a better decision about your next used car.

CARFAX Accident / Damage History

Not all accidents / issues are reported to CARFAX

[Empty text box for accident/damage history details]

Event 1

07/27/2022
 Accident reported:
 moderate damage

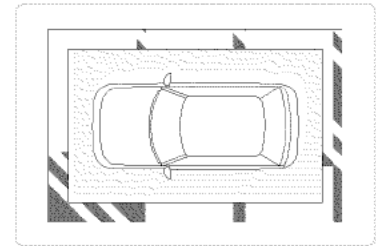
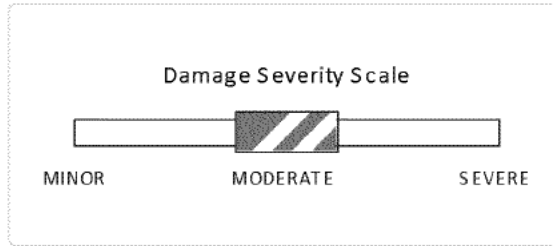

Event 2

06/06/2024
 Accident reported:
 minor damage
 -Vehicle towed

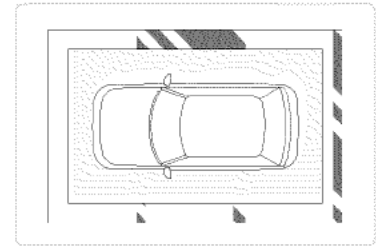
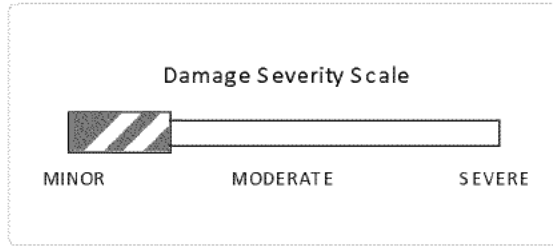

 Additional History Not all accidents / issues are reported to CARFAX	Owner 1
Total Loss No total loss reported to CARFAX.	<input checked="" type="checkbox"/> No Issues Reported
Structural Damage CARFAX recommends that you have this vehicle inspected by a collision repair specialist.	<input checked="" type="checkbox"/> No Issues Reported
Airbag Deployment No airbag deployment reported to CARFAX.	<input checked="" type="checkbox"/> No Issues Reported
Odometer Check No indication of an odometer rollback.	<input checked="" type="checkbox"/> No Issues Indicated
Accident / Damage Accidents reported: 07/27/2022 and 06/06/2024.	Accident Reported
Manufacturer Recall No open recalls reported to CARFAX. Check for open recalls on GM vehicles at recalls.gm.com.	<input checked="" type="checkbox"/> No Recalls Reported
Basic Warranty Original warranty estimated to have 13 months or 14,850 miles remaining. Confirm with dealer or vehicle manufacturer.	<input checked="" type="checkbox"/> Warranty Active

 Title History CARFAX guarantees the information in this section	Owner 1
Damage Brands	Guaranteed

Salvage | Junk | Rebuilt | Fire | Flood | Hail | Lemon

No Problem

Odometer Brands
Not Actual Mileage | Exceeds Mechanical Limits

Guaranteed No Problem



GUARANTEED - None of these title problems were reported by a U.S. state Department of Motor Vehicles (DMV). If you find that any of these title problems were reported by a DMV and not included in this report, you may qualify.
[View Terms](#) | [View Certificate](#)



Ownership History

The number of owners is estimated

Owner 1

Year purchased

2022

Type of owner

Personal lease

Estimated length of ownership

2 yrs. 11 mo.

Owned in the following states/provinces

New Jersey

Estimated miles driven per year

12,114/yr

Last reported odometer reading

35,150



Detailed History

Owner 1
Purchased: 2022



Low mileage! This owner drove less than the industry average of 15,000 miles per year.

Personal Lease Vehicle
12,114 mi/yr

Date	Mileage	Source	Comments
Not Reported		General Motors	Vehicle manufactured and shipped to original dealer  Original Window Sticker
03/03/2022	3	Dealer Inventory	Vehicle offered for sale
03/04/2022	5	Crown Cadillac Inc. Watchung, NJ 908-561-2900 crown Cadillac.com ★ 4.8 / 5.0 344 Verified Reviews	Vehicle sold

♥ 2,418 Customer Favorites

03/04/2022

Crown Cadillac Inc.
Watchung, NJ
866-971-3090
crowncadillacnj.com

★ 4.8 / 5.0

344 Verified Reviews

♥ 2,418 Customer Favorites



Vehicle serviced
-Pre-delivery inspection completed

03/24/2022

New Jersey
Motor Vehicle Dept.
Bayonne, NJ
Title # [REDACTED]

Title issued or updated
-Registration issued or renewed
-First owner reported
-Titled or registered as personal lease vehicle
-Loan or lien reported
-Vehicle color noted as Gray

07/27/2022

Damage Report



Accident reported: moderate damage
-Damage to left front

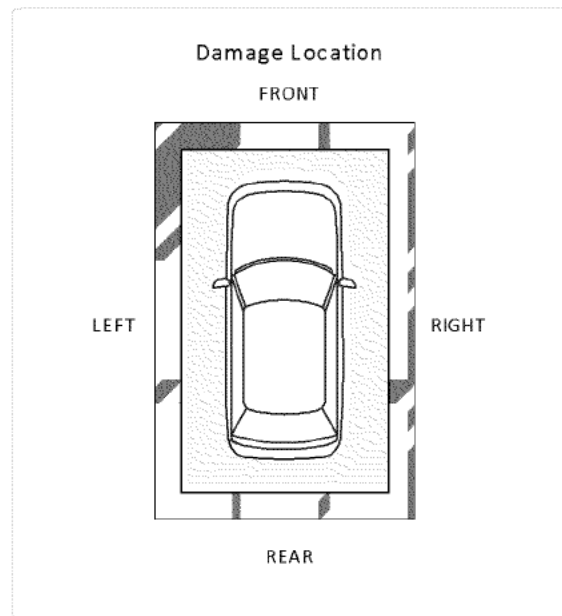
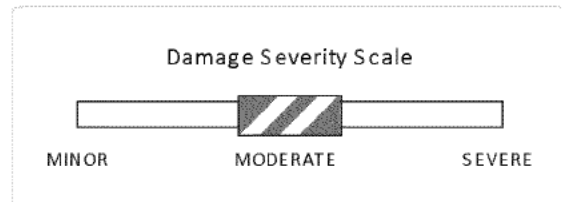

09/15/2022 6,522

Crown Cadillac Inc.
Watchung, NJ
866-971-3090
crowncadillacnj.com

















★ 4.8 / 5.0

344 Verified Reviews



Vehicle serviced
-Maintenance inspection completed
-Oil and Filter changed
-Tires rotated

 2,418 Customer Favorites

01/18/2023		New Jersey Motor Vehicle Dept. Bayonne, NJ		Registration issued or renewed -Registration updated when owner moved the vehicle to a new location -Vehicle color noted as Gray
02/03/2023	12,033	Crown Cadillac Inc. Watchung, NJ 866-971-3090 crowncadillacnj.com ★ 4.8 / 5.0 344 Verified Reviews  2,418 Customer Favorites		Vehicle serviced -Maintenance inspection completed -Oil and  ter changed -Tires rotated
05/24/2023	16,908	Crown Cadillac Inc. Watchung, NJ 866-971-3090 crowncadillacnj.com ★ 4.8 / 5.0 344 Verified Reviews  2,418 Customer Favorites		Vehicle serviced -Maintenance inspection completed -Cabin air  ter replaced/cleaned -Oil and  ter changed -Tires rotated
10/12/2023	22,049	Crown Cadillac Inc. Watchung, NJ 866-971-3090 crowncadillacnj.com ★ 4.8 / 5.0 344 Verified Reviews  2,418 Customer Favorites		Vehicle serviced -Maintenance inspection completed -Oil and  ter changed -Tires rotated -Washer pump replaced
10/18/2023		New Jersey Motor Vehicle Dept. Bayonne, NJ		Registration issued or renewed -Registration updated when owner moved the vehicle to a new location -Vehicle color noted as Gray
03/08/2024	26,922	Crown Cadillac Inc. Watchung, NJ 866-971-3090 crowncadillacnj.com ★ 4.8 / 5.0 344 Verified Reviews  2,418 Customer Favorites		Vehicle serviced -Maintenance inspection completed -Fuel injection system  shed/serviced -Oil and  ter changed
04/01/2024	27,609	Crown Cadillac Inc. Watchung, NJ 866-971-3090 crowncadillacnj.com ★ 4.8 / 5.0 344 Verified Reviews		Vehicle serviced -Maintenance inspection completed -Brakes checked -Fuel  er hose/pipe replaced

♥ 2,418 Customer Favorites

06/06/2024

Damage Report



Accident reported: minor damage
-Damage to right side
-Vehicle towed

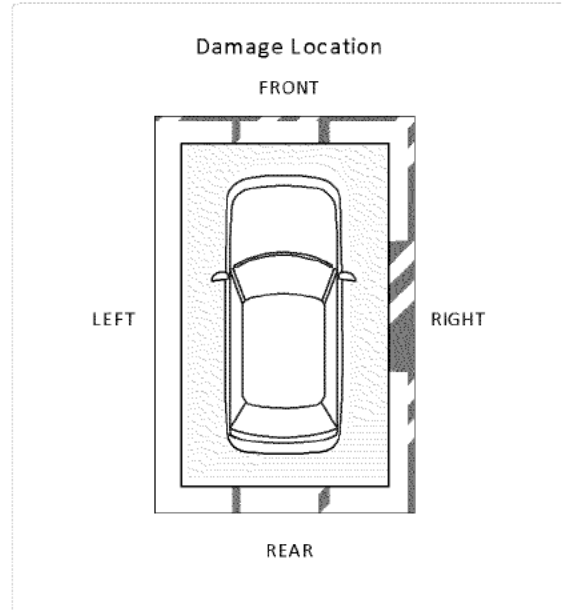
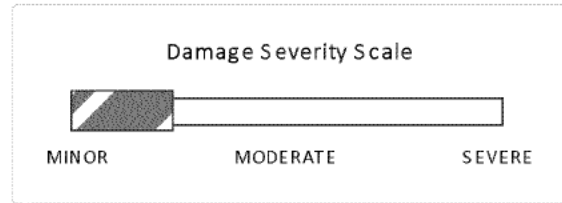

09/05/2024 29,992

Crown Cadillac Inc.
Watchung, NJ
866-971-3090
crowncadillacnj.com

★ 4.8 / 5.0
344 Verified Reviews
♥ 2,418 Customer Favorites



Vehicle serviced
-Antifreeze/coolant flushed/changed
-Battery replaced
-Brake fluid flushed/changed
-Brakes serviced
-Engine replaced
-Rear brake pads replaced
-Rear brakes serviced/adjusted
-Spark plug(s) replaced

02/15/2025 35,150

Crown Cadillac Inc.
Watchung, NJ
866-971-3090
crowncadillacnj.com

★ 4.8 / 5.0
344 Verified Reviews
♥ 2,418 Customer Favorites



Vehicle serviced
-Maintenance inspection completed
-Oil and filter changed
-Tires rotated

This vehicle's oil change history, as reported to CARFAX, aligns with oil changes reported on other 2022 Cadillac Escalade Premium Luxury vehicles -



approximately every 6,500 miles. Track your service history for free at [carfax.com/service](https://www.carfax.com/service).

Have Questions? Consumers, please visit our Help Center at www.carfax.com. Dealers or Subscribers, please visit our Help Center at www.carfaxonline.com.

CARFAX Glossary

Accident Indicator

CARFAX receives information about accidents in all 50 states, the District of Columbia and Canada.

Not every accident is reported to CARFAX. As details about the accident become available, those additional details are added to the CARFAX Vehicle History Report. CARFAX recommends that you have this vehicle inspected by a qualified mechanic.

- According to the National Safety Council, Injury Facts, 2021 edition, 5% of the 276 million registered vehicles in the U.S. were involved in an accident in 2019. Over 77% of these were considered minor or moderate.
- This CARFAX Vehicle History Report is based only on information supplied to CARFAX and available as of 3/14/25 at 1:45:56 PM (CDT). Other information about this vehicle, including problems, may not have been reported to CARFAX. Use this report as one important tool, along with a vehicle inspection and test drive, to make a better decision about your next used car.

CARFAX Well Maintained - Regular Oil Changes

CARFAX identifies a "Well Maintained - Regular Oil Change" vehicle as having a regular oil change history when all its recommended oil changes, based on the vehicle's maintenance schedule, have been reported to CARFAX. CARFAX uses the manufacturer's schedule and assumes normal driving conditions. When an oil change schedule is not available, CARFAX may analyze reported service events to determine what is typical for the same make and model vehicle. Dealers and service shops may publish different recommended service schedules.

Damage Severity

Damage events result in one of the following severity levels:

- Minor: Generally, minor damage is cosmetic (including dents or scratches), may only require reconditioning, and typically does not compromise a vehicle's operation and/or safety.
- Moderate: Moderate damage may affect multiple components of the vehicle and may impair the vehicle's operation and/or safety.
- Severe: Severe damage usually affects multiple components of the vehicle and is likely to compromise the vehicle's operation and/or safety.

CARFAX recommends getting a pre-purchase inspection at a certified collision repair facility.

First Owner

When the first owner(s) obtains a title from a Department of Motor Vehicles as proof of ownership.

Ownership History

CARFAX defines an owner as an individual or business that possesses and uses a vehicle. Not all title transactions represent changes in ownership. To provide estimated number of owners, CARFAX proprietary technology analyzes all the events in a vehicle history. Estimated ownership is available for vehicles manufactured after 1991 and titled solely in the US including Puerto Rico. Dealers sometimes opt to take ownership of a vehicle and are required to in the following states: Maine, Massachusetts, New Jersey, Ohio, Oklahoma, Pennsylvania and South Dakota. Please consider this as you review a vehicle's estimated ownership history.

Title Issued

A state issues a title to provide a vehicle owner with proof of ownership. Each title has a unique number. Each title or registration record on a CARFAX report does not necessarily indicate a change in ownership. In Canada, a registration and bill of sale are used as proof of ownership.

Follow Us:



facebook.com/CARFAX



@CARFAXinc



About CARFAX

CARFAX DEPENDS ON ITS SOURCES FOR THE ACCURACY AND RELIABILITY OF ITS INFORMATION. THEREFORE, NO RESPONSIBILITY IS ASSUMED BY CARFAX OR ITS AGENTS FOR ERRORS OR OMISSIONS IN THIS REPORT. CARFAX FURTHER EXPRESSLY DISCLAIMS ALL WARRANTIES, EXPRESS OR IMPLIED, INCLUDING ANY IMPLIED WARRANTIES OF MERCHANTABILITY OR FITNESS FOR A PARTICULAR PURPOSE.

© 2025 CARFAX, Inc., part of S&P Global. All rights reserved.
3/14/25 1:45:56 PM (CDT)

I have reviewed and received a copy of the CARFAX Vehicle History Report for this 2022 CADILLAC ESCALADE vehicle (VIN: [REDACTED]), which is based on information supplied to CARFAX and available as of 3/14/25 at 2:45 PM (EDT).

Customer Signature

Date

Dealer Signature

Date



Warranty Check™

CARFAX has estimated the remaining original manufacturer warranty coverage based on information reported to us on this 2022 CADILLAC ESCALADE PREMIUM LUXURY ([REDACTED]).

2022 CADILLAC ESCALADE PREMIUM LUXURY

VIN: [REDACTED]

Estimated start date of warranty: 03/24/2022

Last CARFAX reading reported on 02/15/2025: 35,150 miles

Today's Date: 03/14/2025

Type of Coverage	Original Warranty	Estimated Remaining Coverage
Basic	48 months or 50,000 miles	13 months or 14,850 miles
Drivetrain	72 months or 70,000 miles	37 months or 34,850 miles
Emissions	No data reported to CARFAX	
Corrosion	72 months or unlimited mileage	37 months or unlimited mileage
Transferable	No data reported to CARFAX	
Roadside	72 months or 70,000 miles	37 months or 34,850 miles
Safety belt & inflatable restraint	No data reported to CARFAX	
Special Components	No data reported to CARFAX	
Notes	Courtesy Transportation coverage: 6/70,000. First Scheduled Maintenance coverage: 1/Unlimited.	

i CARFAX Warranty Check provides an estimate of this vehicle's remaining warranty coverage. It does not take into account some vehicle history events such as some title brands that may void the original manufacturer warranty or ownership transfers that may decrease warranty coverage. This warranty information is only valid for vehicles manufactured for the United States. Complete warranty coverage information is available for this vehicle at the CADILLAC website.

CARFAX Vehicle History Report Courtesy of:
ESIS GM



CARFAX Buyback Guarantee

Guarantee Coverage:

03/14/2025 - 03/14/2026

CARFAX Vehicle Description:

2022 CADILLAC ESCALADE PREMIUM LUXURY

VIN:



Body Style:

4 Door Wagon/Sport Utility

Driveline:

Rear wheel drive w/ 4X4

Engine:

6.2L V8

You may qualify

if you find that any of these problems were reported by a U.S. Department of Motor Vehicles and were not included in this report.



Severe Damage:

Salvage/Junk
Rebuilt/Reconstructed
Dismantled
Fire/Flood/Hail



Odometer Problems:

Exceeds Mechanical Limits
Not Actual Mileage



Lemon History:

Manufacturer Buyback

Terms and Conditions Apply

[View Terms and Conditions for CARFAX Buyback Guarantee coverage](#)