	GROUP Safety Recall Campaign	MODEL 2011-2014MY Optima (QF/TF) 2012-2014MY Sorento (XMa) 2011-2013MY Sportage (SL)
	NUMBER SC147 (Rev 6, 2/7/2018)	DATE June 2017
SAFETY RECALL CAMPAIGN		
SUBJECT: THETA II ENGINE INSPECTION AND/OR REPLACEMENT		

*** NOTICE**

This bulletin has been revised to include additional information. New/revised sections of this bulletin are indicated by a black bar in the margin area.

This bulletin provides the procedure to inspect, and if necessary, replace the engine long block assembly on the following vehicles:

- All 2011-2013MY Optima (QF/TF) vehicles equipped with the 2.4L Gasoline Direct Injection (GDI) and 2.0L Turbocharged GDI (T-GDI) engines produced from August 12, 2010 through September 27, 2013;
- All 2014MY Optima (QF) vehicles equipped with the 2.4L Gasoline Direct Injection (GDI) and 2.0L Turbocharged GDI (T-GDI) engines produced at KMMG from August 28, 2013 through May 15, 2014;
- All 2012-2014MY Sorento (XMa) vehicles equipped with the 2.4L Gasoline Direct Injection (GDI) engines produced from April 19, 2011 through February 10, 2014; and
- All 2011-2013MY Sportage (SL) vehicles equipped with the 2.0L Turbo Gasoline Direct Injection (T-GDI) engines produced from December 30, 2010 through August 30, 2013.

Metal debris may have been generated from factory machining operations of the engine crankshaft and may not have been completely removed from the crankshaft's oil passages during the cleaning process. It was also determined that the additional machining processes of the crankpins may have caused uneven surface roughness. These combined conditions can restrict oil flow to the bearings increasing the potential for premature bearing wear.

A worn connecting rod bearing will produce a cyclic knocking noise from the engine and may also result in the illumination of the vehicle's engine warning and/or oil pressure lamp on the instrument panel. If the warnings are ignored and the vehicle is continued to be driven, the bearing may fail and the vehicle could stall while in motion. An engine stall at higher speeds can increase the risk of a crash.

Follow the procedure outlined in this bulletin to inspect, and if necessary, replace the engine long block assembly. Before conducting the procedure, verify the vehicle is included in the list of affected VINs.

File Under: <Safety Recall Campaign>

Circulate To: **General Manager** **Service Manager** **Parts Manager**
 Service Advisors **Technicians** **Body Shop Manager** **Fleet Repair**

*** NOTICE**

There is no charge to the vehicle owner for this repair. Under applicable law, you may not sell or otherwise deliver any affected new vehicle until it has been repaired pursuant to the procedures set forth in this bulletin.

To ensure complete customer satisfaction, always remember to refer to WebDCS Warranty Coverage (validation) Inquiry Screen (Service → Warranty Coverage → Warranty Coverage Inquiry) for a list of any additional campaigns that may need to be performed on the vehicle before returning it to the customer.

For Optima models included in SC147:

- VINs that start with “5” are designated Optima (QF) and produced in the United States.
- VINs that start with “K” are designated Optima (TF) and produced in Korea.

Inspection Procedure:

1. Prior to inspection, ensure the KDS is fully charged and is connected to the internet every day to ensure the latest update is received and installed.
 - Engine oil level should be at the “FULL” mark. Top off with 5W-30 if required.
 - Test requires the engine to be in satisfactory running condition and able to idle normally.
 - Engine coolant temperature should be above minimum test temperature: 185°F (85°C).

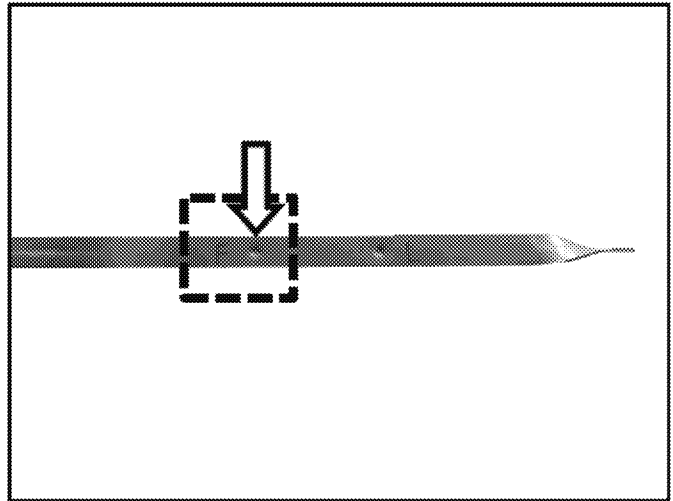

If the engine's running condition is poor due to issues unrelated to a connecting rod knocking noise (faulty sensors, intake/exhaust manifold leak, catalytic converter, etc.), diagnose and repair prior to performing this inspection procedure. If the engine cannot be tested or has other major concerns, **see Warranty Claim Authorization information on page 19.**

2. With the engine off, remove the dipstick (A).

*** NOTICE**

Engine cover removed in images for demonstration-only purposes.

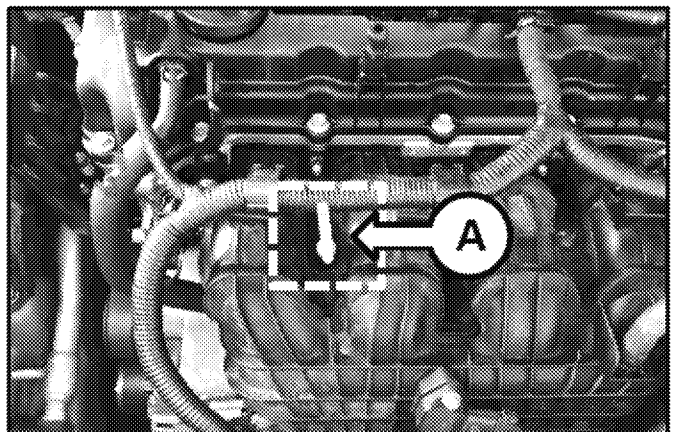

SUBJECT: THETA II ENGINE INSPECTION AND/OR REPLACEMENT (SC147)

3. Insert the engine noise tester SST adapter (B) into the dipstick tube then start and idle the engine.

*** NOTICE**

To avoid false readings, ensure the adapter (B) is properly inserted into the dipstick tube and that the tube is not in contact with the intake manifold.

If the dipstick tube is not centered and is close to or touching the manifold, carefully adjust (bend) and center the dipstick tube with a pry bar.



Not Centered

Centered

[Click here for a video tutorial of the Inspection Procedure.](#)

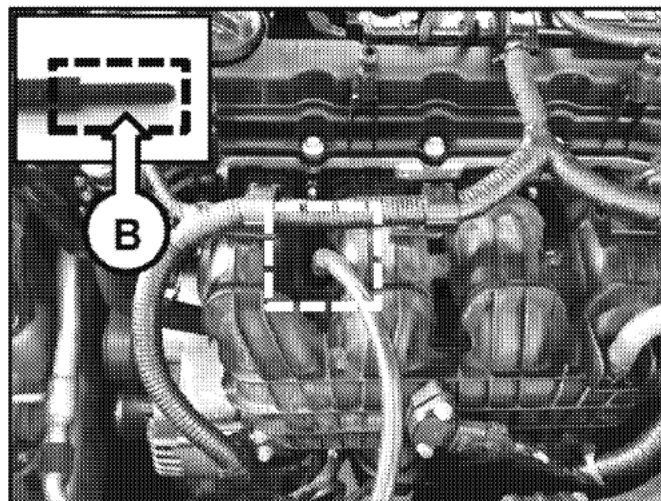
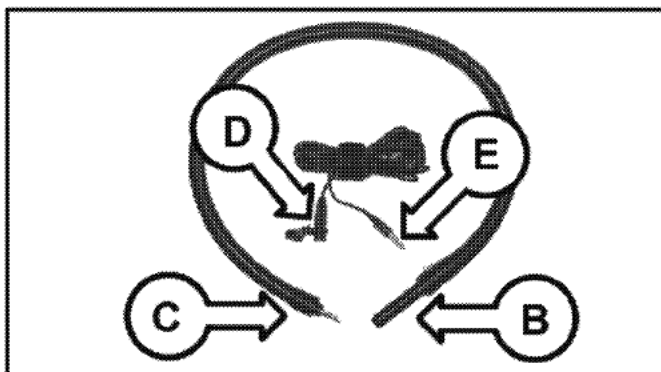

4. Connect the 3.5 mm male end of the engine noise tester SST (C) to the 3.5 mm female end of the extension cable (D).

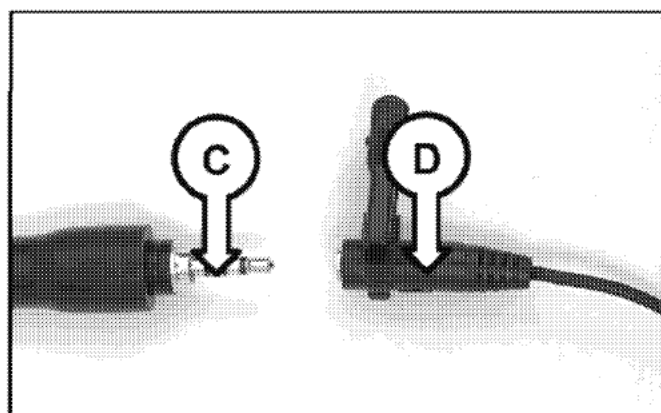

5. Attach the SST clip of the extension cable (D) to the hood latch.

*** NOTICE**

Make sure to route the extension cable away from moving parts (pulleys, fan, and belts and be careful not to get it pinched between door and body or window, etc.).

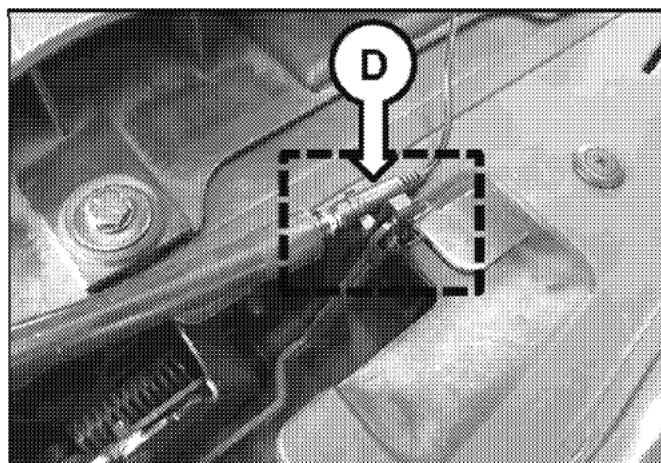

SUBJECT: THETA II ENGINE INSPECTION AND/OR REPLACEMENT (SC147)

6. Connect the 3.5 mm male end (E) of the extension cable to the headphone port located at the upper left corner (KDS version 1.0) or at the bottom of the tablet (KDS version 2.0).

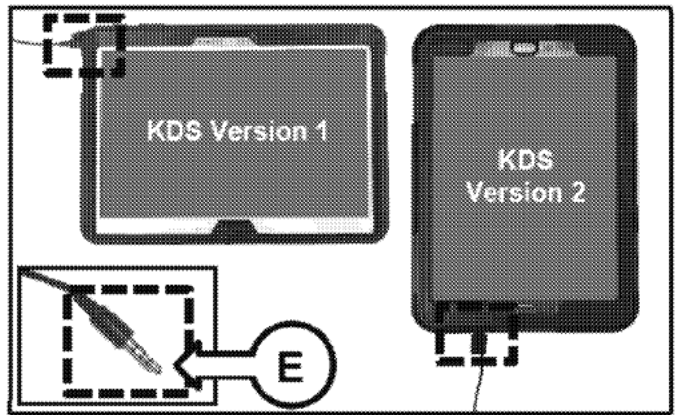

7. Connect the VCI-II to the OBD-II connector and launch the KDS application from the KDS tablet home page.



8. Confirm communication with VCI (F) and then configure the vehicle (G) using the **AUTO VIN** (H) feature.

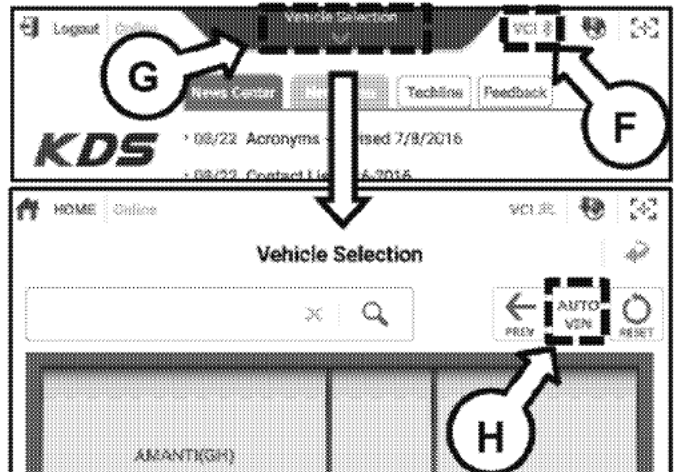

9. Swipe up the "More" tab from the lower screen of the KDS and select "Special Inspection".

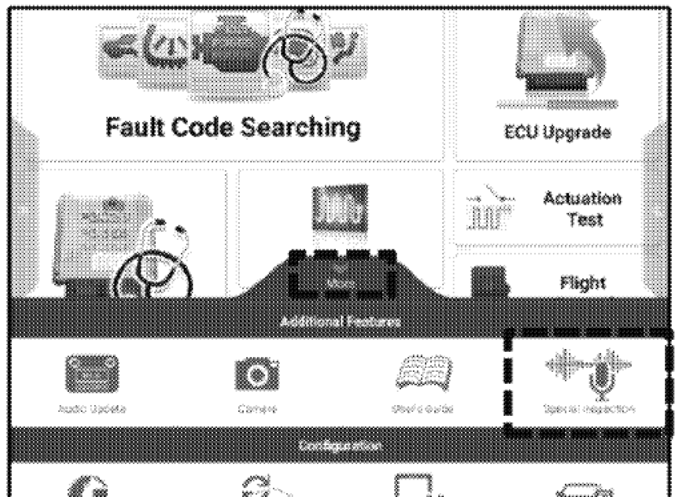

*** NOTICE**

If the vehicle model/model year does not qualify for this campaign, a message will pop up; if so, verify that the vehicle is included in the list of affected VINs for SC147.

SUBJECT: THETA II ENGINE INSPECTION AND/OR REPLACEMENT (SC147)

13. Follow the instructions on the screen then select "Next".

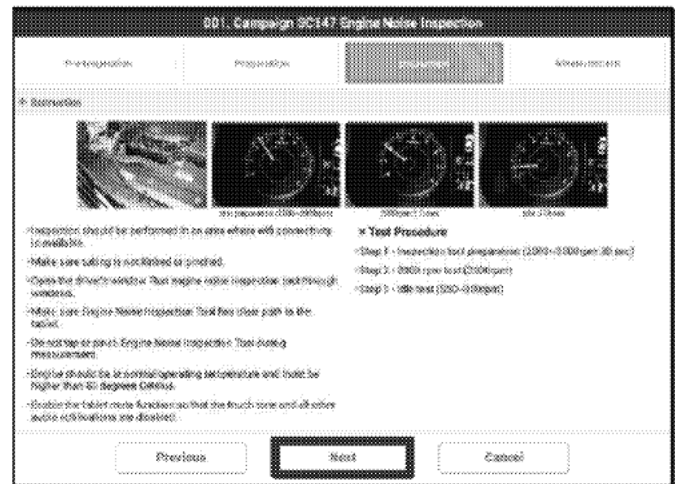

14. Prior to the initial measurement, the program will automatically check if the engine noise tester is installed and operating correctly at engine idle and perform an internal diagnosis.

Begin the second part of the engine noise tester check by selecting "Start".

*** NOTICE**

If the measured noise level is too low or abnormally high, an engine noise tester inspection message will pop up. Check and correct as necessary and start again.

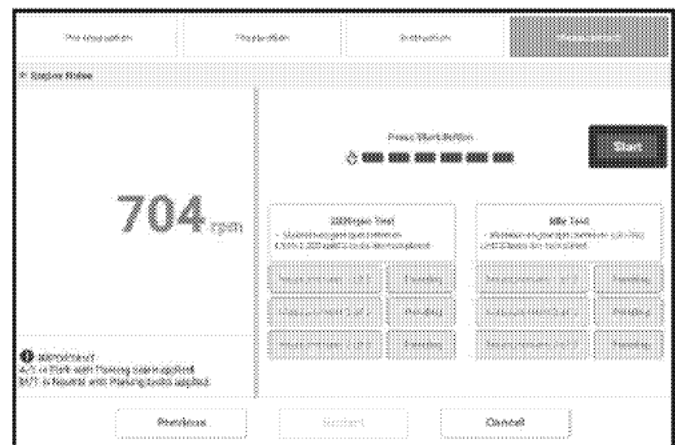

15. With the vehicle in Park (A/T) / Neutral (M/T), increase and maintain the engine speed at 2,000-3,000 RPM for thirty (30) seconds.

The program will automatically proceed to the next step when the engine noise tester is ready.

*** NOTICE**

Once the RPM is in the specified range, the time count (green bars) will be initialized.

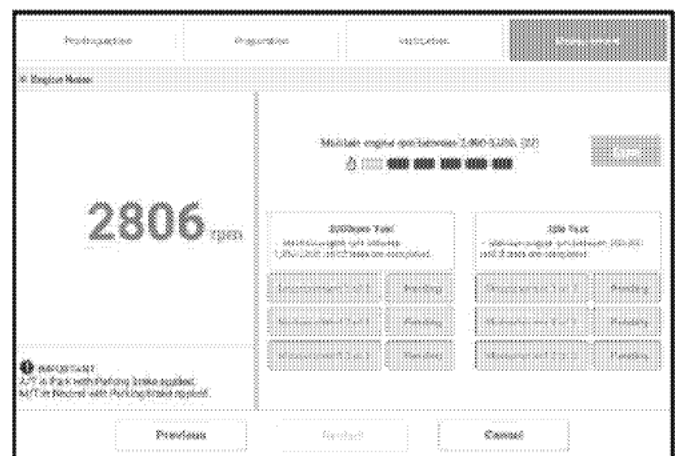

SUBJECT: THETA II ENGINE INSPECTION AND/OR REPLACEMENT (SC147)

16. With the vehicle in Park (A/T) / Neutral (M/T), begin the "2000rpm Test" by increasing and maintaining engine speed between 1,900-2,100 (2.4L) or 1,900-2,200 (2.0T) RPM until all three (3) measurements are complete.
17. When the "2000rpm Test" is complete, release the accelerator pedal so that engine maintains idle state for the "Idle Test".
18. The "Idle Test" will automatically begin. Keep the engine at idle and wait until all three (3) measurements are complete.

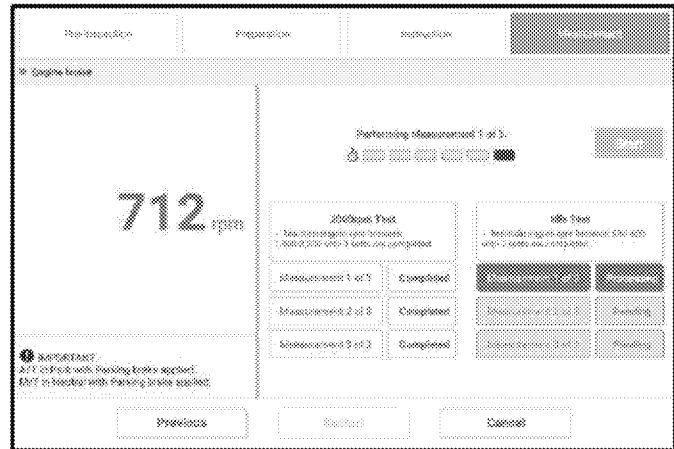
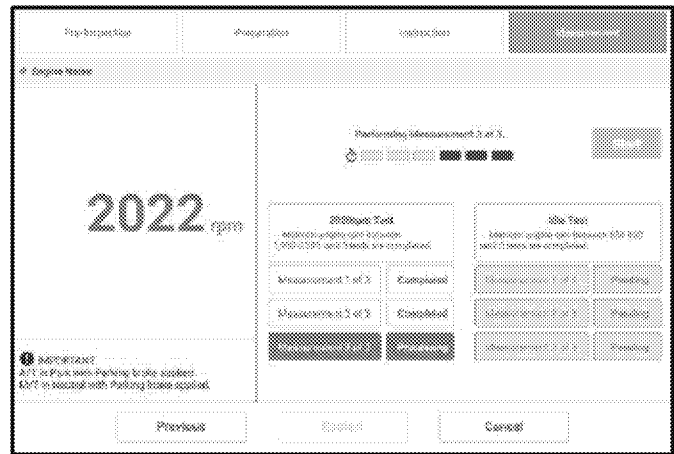

19. After the completion of the engine noise inspection, the KDS will automatically generate/display a "PASS" or "NO PASS" result.
 - If the inspection result is "PASS", proceed to the next step.
 - If the inspection result is "NO PASS," proceed to the replacement procedure on page 9*.
 - If the inspection result is "RETEST" with an error code, see Adapter Error Code chart in Appendix 4 on page 25 for corrective action then repeat the inspection procedure starting from step 9.



***For 14MY Sorento (XMa) vehicles only: check the underhood emissions label and record whether the label references ULEV or SULEV. This information is needed to select/order the correct replacement engine.**

KIA		KIA MOTORS CORPORATION VEHICLE EMISSION CONTROL INFORMATION	
Conforms to regulations :		2014 MY	
U.S. EPA : T285 LDV	OBD : CA II	Fuel : Gasoline	
California : ULEV PC	OBD : CA II	Fuel : Gasoline	
Group : EKMAV02.44PE	DFVHC02S(Z)WU-TWC/TWC		
Equip. : EKMXR01300RE	No adjustments needed		A402
[WARNING]		15417-26-102	
Loaded IM testing of permanent four-wheel drive or traction control equipped vehicles must be conducted on a four-wheel drive speed synchronized dynamometer. Otherwise, a non-loaded test procedure must be performed.			

SUBJECT: THETA II ENGINE INSPECTION AND/OR REPLACEMENT (SC147)

20. Select "Finish" to complete the engine noise inspection. Ensure the KDS is connected to the internet and the "Special Inspection" KDS application is open to automatically submit the results to the Kia Server. To save and/or print the results as PDF, select "Print".

If the KDS is not connected to the internet, up to five (5) results will stay pending in the queue until the KDS is connected to the internet with the "Special Inspection" application open.

Note: The five (5) pending results must be submitted before a sixth (6th) test can be conducted.

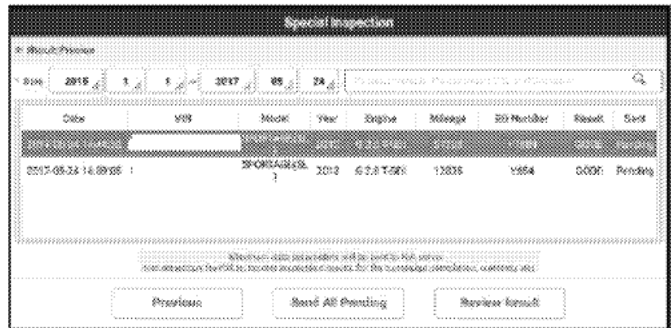
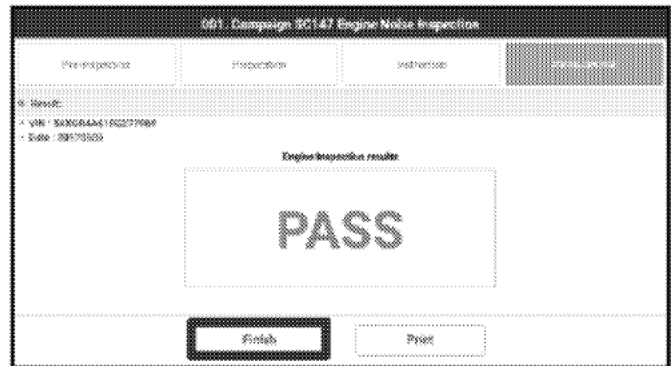

21. Disconnect the engine noise tester from the KDS and carefully remove the adapter (B) from the dipstick tube by grasping the engine noise tester adapter.
22. For 2011-2013MY vehicles only: If the vehicle is equipped with a **YELLOW** dipstick, discard the dipstick and replace it with a new **ORANGE** one.

*** NOTICE**

If the vehicle is equipped with a **RED** dipstick, replacement is not necessary.

On all vehicles with an inspection result of "PASS": Change the oil and filter and refill with 5W-30 oil. Use the new (ORANGE) or verified (RED) dipstick to verify proper oil level after oil change and if applicable, reset the maintenance reminder on the instrument cluster.

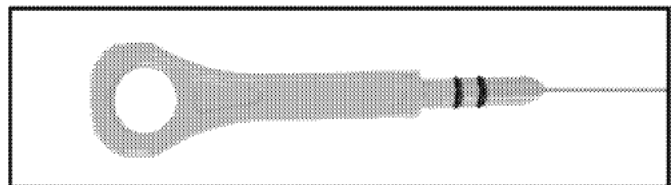

Yellow Dipstick (P/N: 26611 2G020)

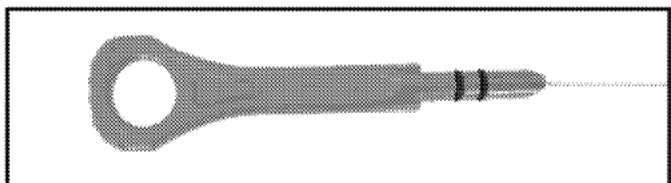

Orange Dipstick (P/N: 26611 2G050QQK)

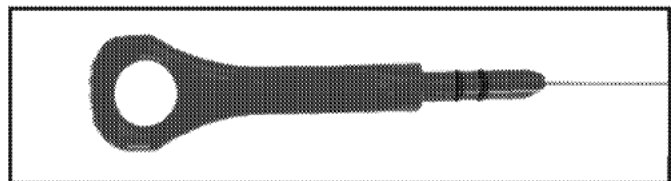

**Red Dipstick (P/N: 26611 2G040)
(NO REPLACEMENT REQUIRED)**

SUBJECT: THETA II ENGINE INSPECTION AND/OR REPLACEMENT (SC147)**Replacement Procedure:***** NOTICE**

For engine replacements under SC147, no PWA is required if the inspection procedure yields a NO PASS result. If there are any OTHER engine-related issues requiring replacement of the engine, open a Techline case for PWA. See page 19 for details about PWA and Warranty Claim Authorization.

Regular Trained Technician requirements apply.

*** NOTICE**

If the inspection results in a "NO PASS", perform the verification steps below:

- a) Are there any abnormal noises which do not always follow engine RPM and are intermittent?
 - If so, check for noise from other sources such as exhaust, engine mounts, etc. and correct as necessary.
- b) Are there any abnormal noises from engine driven accessories?
 - If necessary, remove the serpentine belt to isolate all belt driven accessories. Limit engine run time during any inspection and correct as necessary.

Once any noise contributing issues are corrected, perform the KDS Inspection Procedure again.

If the following inspection results in a PASS, perform step 22 of the Service Procedure (Inspection Results = PASS) on page 8.

If the following inspection still results in a NO PASS, proceed to replace the Engine assembly by referring the Service Procedure on this page.

1. Remove the engine assembly by referring to the "Engine And Transmission (Transaxle) Assembly → Engine And Transmission (Transaxle) Assembly → Repair procedures" chapter in the applicable Shop Manual on KGIS.

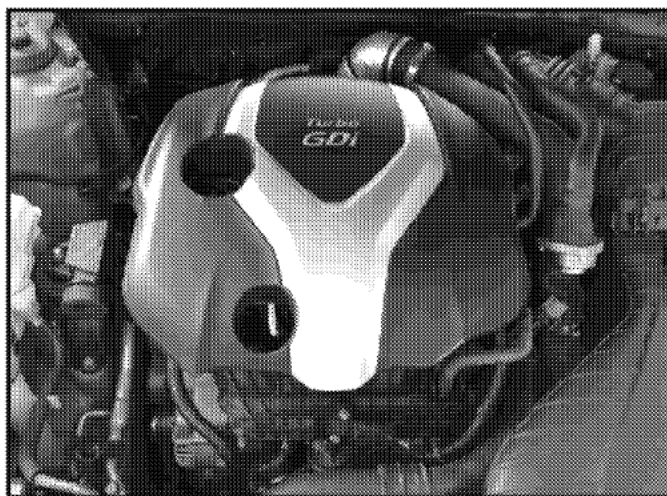

2. After removal of the engine from the vehicle, remove all components that will need to be transferred by referring to the applicable Shop Manual on KGIS.
3. Place the new engine block on an engine stand.
4. Install all removed components from the old engine block onto the new engine block utilizing all parts from Service Kit I and II. Be advised of notes below.

Notes:

High Pressure Pump & Roller Tappet:

- Refer to TSB ENG083 for special attention and handling procedures of GDI-specific components.
- When installing the high pressure pump and roller tappet onto the new engine, apply engine oil to the roller tappet, and O-rings of the high pressure pump.

Tightening torques of pump bolts:

9.4 – 10.9 lb.ft (12.8 – 14.7 N.m,
1.3 – 1.5 kgf.m)

Tightening torques of pipe flare nut:

19.5 – 23.9 lb.ft (26.5 – 32.4 N.m,
2.7 – 3.3 kgf.m)

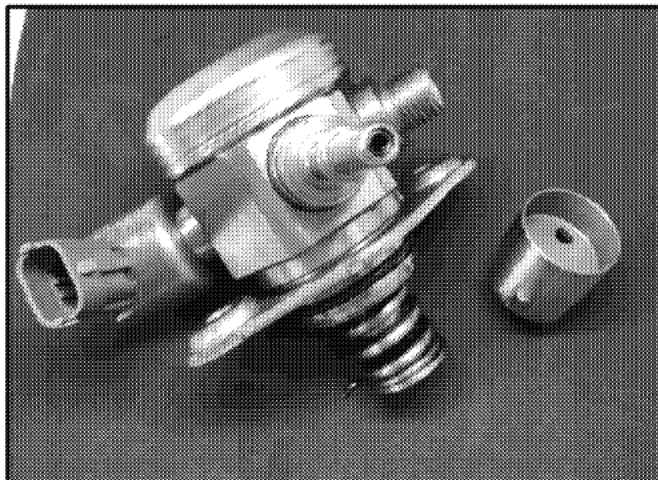
**⚠ WARNING**

Refer to TSB ENG083 for gasoline direct injection (GDI) specific information, including related warnings and cautions for handling high fuel pressure system components.

Delivery Pipe:

- Refer to TSB ENG083 for special attention and handling procedures of GDI-specific components.
- Prior to installing the delivery pipe, be sure to replace all of the injector O-rings and injector retainers.
- Prior to installing the delivery pipe, apply engine oil to the injector O-rings.
- When installing the delivery pipe, use caution not to damage the tip of the injector.
- Be sure to replace the delivery pipe retaining bolts and torque them in the sequence shown.

Tightening torque of bolts:

13.7 – 17.4 lb.ft (18.6 – 23.5 N.m,
1.9 – 2.4 kgf.m)

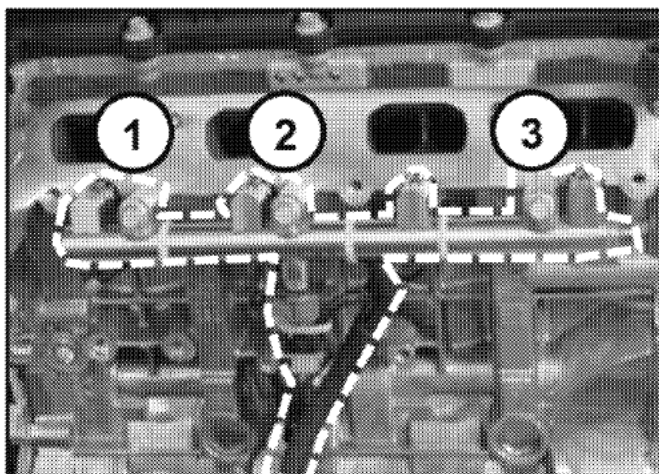
*** NOTICE**

Combustion seals must be compressed after installation and before attempting to install into the cylinder head. Use SST 09353 2B000 (refer to TSB ENG083).

*** NOTICE**

Refer to "Guidelines in case of Catastrophic Failure" on page 14.

Dipstick Tube & Dipstick:

- Prior to installing the new tube, lubricate the o-ring located at the bottom of the tube with engine oil.
- Discard the YELLOW dipstick and install the RED one, included in Service Kit I.

Tightening torque of bolt:

**5.8 – 8.7 lb.ft (7.8 – 11.8 N.m,
0.8 - 1.2 kgf.m)**

Intake Manifold:

- Refer to "Guidelines in case of Catastrophic Failure" on page 14.
- Prior to installation, replace the intake manifold gaskets.
- Torque bolts in the sequence shown.

Tightening torque of bolts:

**13.7 – 17.4 lb.ft (18.6 – 23.5 N.m,
1.9 – 2.4 kgf.m)**

Exhaust Manifold:

- Refer to "Guidelines in case of Catastrophic Failure" on page 14.
- In a case of a catastrophic engine failure, use a bore/videoscope and inspect the exhaust manifold for any metallic debris and remove.
- All engines supplied under this campaign have the exhaust manifold studs configured for SULEV engines.
- Using the pictures to the right, check the exhaust manifold stud location and quantity. Relocate as required for ULEV engines and obtain one (1) extra from the removed engine.
- Prior to installation, replace the exhaust manifold gasket and front muffler gasket.
- Torque nuts in the sequence shown.

Tightening torque of nuts:

**36.2 – 39.7 lb.ft (49.0 – 53.9 N.m,
5.0 – 5.5 kgf.m)**

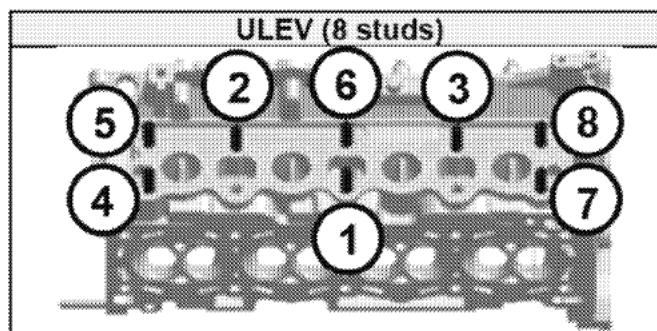
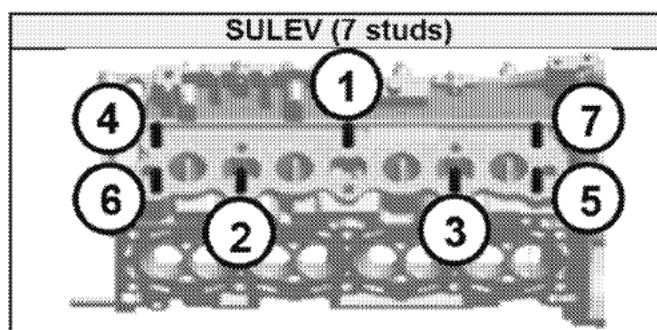
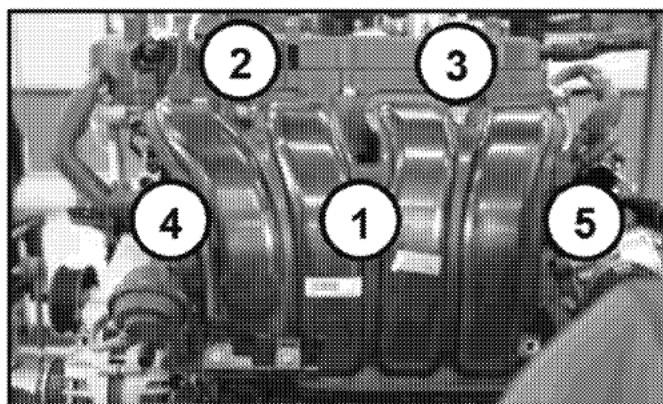
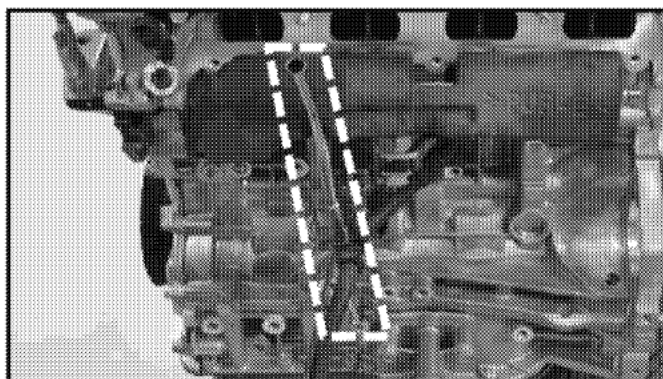

SUBJECT: THETA II ENGINE INSPECTION AND/OR REPLACEMENT (SC147)

- On Turbo engines, replace the turbocharger oil feed line and gaskets.

Tightening torque of oil feed line bolt:
8.7 – 13.0 lb.ft (11.8 – 17.7 N.m,
1.2 – 1.8 kgf.m)

Tightening torque of oil feed line nuts:
5.8 – 8.7 lb.ft (7.8 – 11.8 N.m,
0.8 – 1.2 kgf.m)

Tightening torque of oil drain line nuts and bolts:

5.8 – 8.7 lb.ft (7.8 – 11.8 N.m,
0.8 – 1.2 kgf.m)

- Torque exhaust manifold nuts in the sequence shown.

Tightening torque of nuts:
36.2 – 39.7 lb.ft (49.0 – 53.9 N.m,
5.0 – 5.5 kgf.m)

Oil Cooler Tube Assembly:

New engines may be supplied with a different oil cooler. Use steps below to determine the need for a replacement oil cooler tube assembly.

- If the new engine's (bigger) oil cooler (A) does not match the old engine's (smaller) oil cooler (B), replace the oil cooler tube assembly with the improved part. See parts table on page 15.
- If the new engine's (bigger) oil cooler (A) matches the old engine's (bigger) oil cooler (A), reuse the old engine's oil cooler tube assembly.
- If the new engine's (smaller) oil cooler (B) matches the old engine's (smaller) oil cooler (B), reuse the old engine's oil cooler tube assembly.

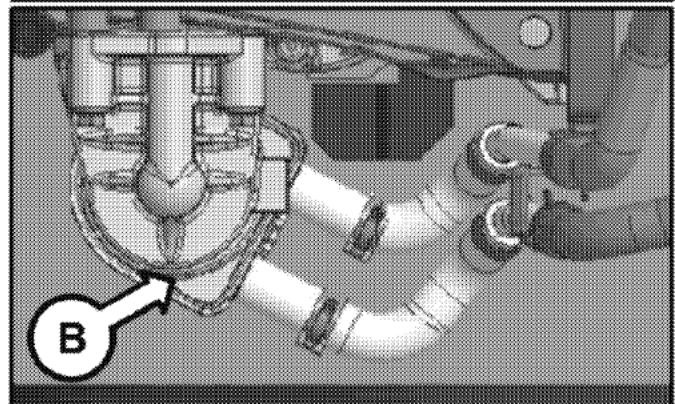
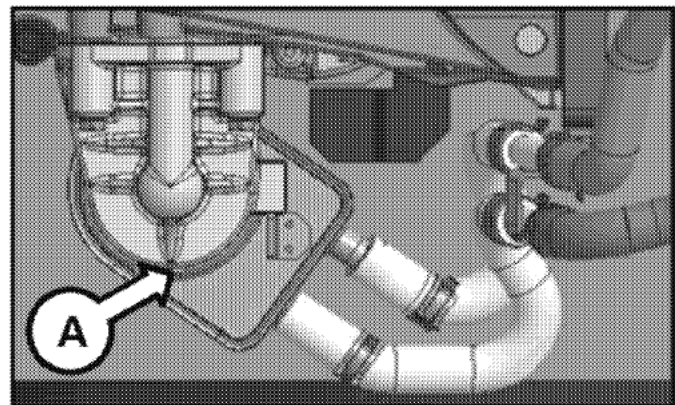
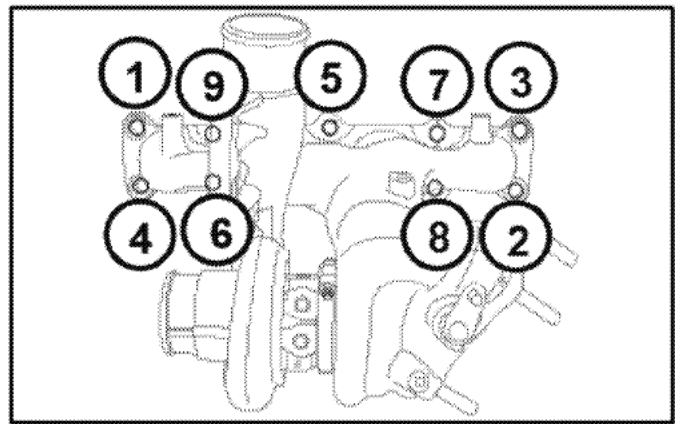

Drive Plate / Flywheel Bolts:

- Replace all seven (7) drive plate (AT) or flywheel (MT) bolts.

Tightening torque of nuts:
86.8 – 93.9 lb.ft (117.7 – 125.5 N.m,
12.0 – 13.0 kgf.m)

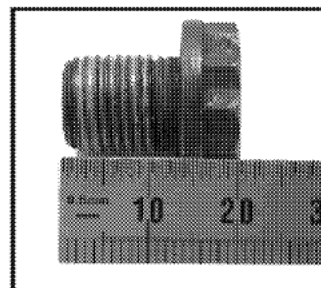

Drive Plate Bolt (A/T)

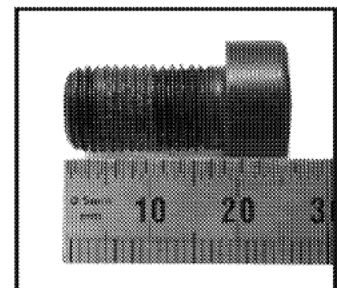

Flywheel Bolt (M/T)

SUBJECT: THETA II ENGINE INSPECTION AND/OR REPLACEMENT (SC147)
Torque Converter

- If the torque converter has moved from the fully inserted position, carefully push inward while rotating the torque converter until it is recessed approximately 9/16 – 5/8" (14 – 16mm) (☑) into the transaxle case when reinstalling the automatic transaxle.

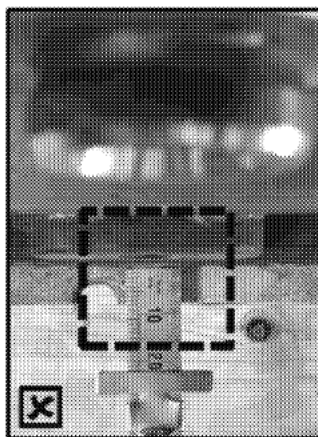

Not Fully Inserted

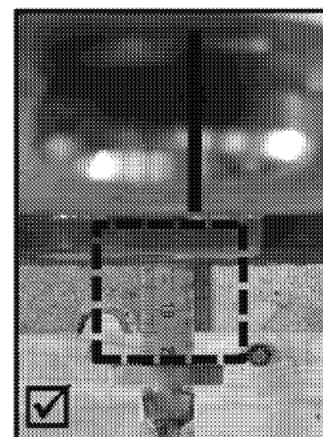

Fully Inserted

5. Reinstall the assembled engine and transmission/transaxle into the vehicle.

Be sure to:

- Fill crankcase with 5W-30 oil (~5.8 quarts).
 - Fill and bleed the cooling system with 50/50 coolant or mixture appropriate for area.
 - Pressurize the fuel system before starting the vehicle.
 - Reset engine adaptive values and perform steering angle sensor calibration.
6. Verify proper operation of the vehicle with road test, and erase any stored DTCs (e.g., EPS, ESC, and TPMS) that may have been set by this procedure. Verify no leaks exist and ensure engine oil and coolant are at their proper level.

If any DTCs are still active, follow any related diagnosis and repair as needed

7. Prior to discarding the removed engine, disable it to prevent reuse by using a large mallet and striking firmly at the center of the starter mount tab on the removed engine to break off the tab.

Provide the removed starter mount tab to your dealership's Parts Department for campaign engine core charge reimbursement request processing.

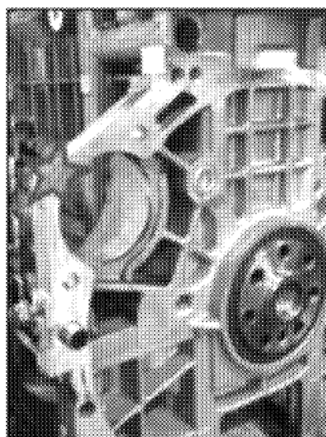
★ NOTICE

After the starter mount tab is removed, the engine core must be held for five (5) days following claim approval for SC147. In the event an engine core is requested for return, your Service or Parts Manager will be contacted with return instructions.

*** NOTICE****Guidelines in case of Catastrophic Failure:**



Replacement engines can be damaged due to ingestion of foreign material soon after installation. The source of this foreign material has been found to be metal debris from the original (damaged) engine. When an engine fails due to connecting rod breakage or piston failure, especially when the damage includes the combustion chamber area (valves/pistons/rings), pieces of metal or debris can be pushed past the intake valves and come to rest in the intake or exhaust manifold. After engine replacement, this metal debris will be pulled back into the engine via engine vacuum, usually during start up or during the first several miles of operation. Variable length intake runner systems are especially susceptible to this as the metal debris may come to rest on either side of the intake butterfly valves. In case of catastrophic failure, replace the intake manifold.

Do not replace intake or exhaust manifold if the engine is running and has a bearing or rod knock only.

AFFECTED VEHICLE RANGE:

Model	Production Date Range
Optima (QF/TF)	August 12, 2010 through September 27, 2013
Optima (QF)	August 28, 2013 through May 15, 2014
Sorento (XMa)	April 19, 2011 through February 10, 2014
Sportage (SL)	December 30, 2010 through August 30, 2013

REQUIRED TOOL:

Tool Name	Tool Part No.	Figure	Comments
Engine Noise Tester SST	GIT1XTDCP005		Auto-shipped to Dealers. For replacements, contact Snap-On Business Solutions at (888) 542-1011.
Torque Wrench Socket	09314 3Q100		Refer to TSB ENG083 for detailed usage instructions
Injector Combustion Seal Ring Installer	09353 2B000		



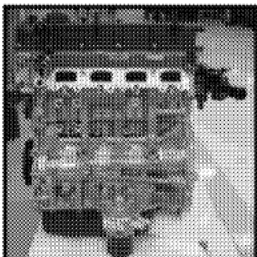





SUBJECT: THETA II ENGINE INSPECTION AND/OR REPLACEMENT (SC147)
REQUIRED PARTS:

Part Name	MY	Model	Part Number		Figure
			2.4GDI	2.0T-GDI	
Engine Long Block	2011-2013	QF	21101 2GK05QQK* or 21101 2GK14QQK*	21101 2GK07QQK** or 21101 2GK15QQK**	
		TF	21101 2GK14QQK*	21101 2GK15QQK**	
		SL	-	21101 2GK13QQK	
	2012-2013	XMa	21101 2GK09QQK	-	
	2014	QF	21101 2GK06QQK	21101 2GK08QQK	
		XMa ULEV***	21101 2GK10QQK or 21101 2GK11QQK	-	
		XMA SULEV***	21101 2GK11QQK	-	

*2.4GDI engines for 2011-2013 QF and TF are compatible and interchangeable.

**2.0T-GDI engines for 2011-2013 QF and TF are compatible and interchangeable.

***See page 7 for details about underhood label check.

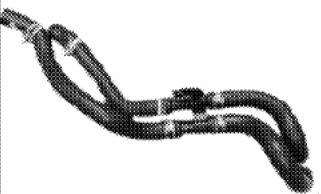
Part Name	Engine	Part Number	Figure
Dipstick	11-13MY 2.4GDI and 2.0T-GDI	26611 2G050QQK	
Oil Filter	All 2.4GDI and 2.0T-GDI	26300 35504	
Drain Plug Washer	All 2.4GDI and 2.0T-GDI	21513 23001	
Service Kit I	2.4GDI	21111 2GK50QQK	
	2.0T-GDI	21111 2GK60QQK	
Service Kit II	2.4GDI and 2.0T-GDI	21111 2GK70QQK	
Drive Plate Bolts	2.4GDI and 2.0T-GDI	23311 25050 (AT)	
		23231 25200 (MT)	
Oil Cooler Tube Assembly (replacement is conditional, refer to page 12)	2.4GDI	25470 2G050QQK	
	2.0T-GDI	25470 2G650QQK	

SUBJECT: THETA II ENGINE INSPECTION AND/OR REPLACEMENT (SC147)
WARRANTY INFORMATION:
N Code: N99 C Code: C99

Model	Claim Type	Causal P/N	Qty.	Test Result	Repair Description	Labor Op Code	Op Time	Replacement P/N	Qty.
Opt. (QF)	R	23060 2G400	0	PASS	(SC147) Engine Noise Inspection PASS & LOF	171A2911	0.7 M/H	26300 35504	1
								21513 23001	1
					(SC147) Engine Noise Inspection PASS , Dipstick Replacement, & LOF	171A2910	0.7 M/H	26611 2G050QQK	1
								26300 35504	1
					21513 23001			1	
				NO PASS	(SC147) <u>2.4L GDI</u> Engine Noise Inspection NO PASS , & Engine Replacement	171A29R0	8.5 M/H	21111 2GK50QQK	1
								21111 2GK70QQK	1
								(AT) 23311 25050	1
								(MT) 23231 25200	
								(11-13MY) 21101 2GK05QQK or 21101 2GK14QQK	1
								(14MY) 21101 2GK08QQK	
				NO PASS	(SC147) <u>2.0T-GDI</u> Engine Noise Inspection NO PASS , & Engine Replacement	171A29R1	8.8 M/H	21111 2GK60QQK	1
								21111 2GK70QQK	1
								(AT) 23311 25050	1
								(MT) 23231 25200	
								(11-13MY) 21101 2GK07QQK or 21101 2GK15QQK	1
								(14MY) 21101 2GK08QQK	
				NO TEST	(SC147) <u>2.4L GDI</u> Engine Replacement Only	171A29R2	8.1 M/H	21111 2GK50QQK	1
								21111 2GK70QQK	1
								(AT) 23311 25050	1
	(MT) 23231 25200								
	(11-13MY) 21101 2GK05QQK or 21101 2GK14QQK	1							
	(14MY) 21101 2GK08QQK								
NO TEST	(SC147) <u>2.0T-GDI</u> Engine Replacement Only	171A29R3	8.4 M/H		21111 2GK60QQK	1			
					21111 2GK70QQK	1			
					(AT) 23311 25050	1			
					(MT) 23231 25200				
				(11-13MY) 21101 2GK07QQK or 21101 2GK15QQK	1				
	(14MY) 21101 2GK08QQK								

SUBJECT: THETA II ENGINE INSPECTION AND/OR REPLACEMENT (SC147)

Model	Claim Type	Causal P/N	Qty.	Test Result	Repair Description	Labor Op Code	Op Time	Replacement P/N	Qty.				
Opt. (TF)	R	23060 2G400	0	PASS	(SC147) Engine Noise Inspection PASS & LOF	17104411	0.7 M/H	26300 35504	1				
								21513 23001	1				
					(SC147) Engine Noise Inspection PASS , Dipstick Replacement, & LOF	17104410	0.7 M/H	26611 2G050QQK	1				
								26300 35504	1				
							NO PASS	(SC147) <u>2.4L GDI</u> Engine Noise Inspection NO PASS , & Engine Replacement	171044R0	8.5 M/H	21111 2GK50QQK	1	
								21111 2GK70QQK			1		
											(AT) 23311 25050	1	
										(MT) 23231 25200			
											21101 2GK05QQK or 21101 2GK14QQK	1	
								(SC147) <u>2.0T-GDI</u> Engine Noise Inspection NO PASS , & Engine Replacement	171044R1	8.8 M/H	21111 2GK60QQK	1	
												21111 2GK70QQK	1
											(AT) 23311 25050	1	
										(MT) 23231 25200			
											21101 2GK07QQK or 21101 2GK15QQK	1	
								NO TEST	(SC147) <u>2.4L GDI</u> Engine Replacement Only	171044R2	8.1 M/H	21111 2GK50QQK	1
													21111 2GK70QQK
							(AT) 23311 25050		1				
						(MT) 23231 25200							
							21101 2GK05QQK or 21101 2GK14QQK	1					
					(SC147) <u>2.0T-GDI</u> Engine Replacement Only	171044R3	8.4 M/H	21111 2GK60QQK	1				
									21111 2GK70QQK	1			
							(AT) 23311 25050	1					
						(MT) 23231 25200							
							21101 2GK07QQK or 21101 2GK15QQK	1					

SUBJECT: THETA II ENGINE INSPECTION AND/OR REPLACEMENT (SC147)

Model	Claim Type	Causal P/N	Qty.	Test Result	Repair Description	Labor Op Code	Op Time	Replacement P/N	Qty.
Sor. (XMa)	R	21020 2G010	0	PASS	(SC147) Engine Noise Inspection PASS & LOF	171A3011	0.7 M/H	26300 35504	1
								21513 23001	1
					(SC147) Engine Noise Inspection PASS , Dipstick Replacement, & LOF	171A3010	0.7 M/H	26611 2G050QQK	1
								26300 35504	1
					21513 23001			1	
				NO PASS	(SC147) <u>2.4L 2WD</u> Engine Noise Inspection NO PASS , & Engine Replacement	171A30R0	8.5 M/H	21111 2GK50QQK	1
								21111 2GK70QQK	1
								(AT) 23311 25050	1
								(MT) 23231 25200	
					(12-13MY) 21101 2GK09QQK	1			
					(14MY ULEV) 21101 2GK10QQK				
					(14MY ULEV or SULEV) 21101 2GK11QQK				
					(SC147) <u>2.4L AWD</u> Engine Noise Inspection NO PASS , & Engine Replacement	171A30R1	8.7 M/H	21111 2GK50QQK	1
								21111 2GK70QQK	1
								(AT) 23311 25050	1
								(MT) 23231 25200	
					(12-13MY) 21101 2GK09QQK	1			
				(14MY ULEV) 21101 2GK10QQK					
				(14MY ULEV or SULEV) 21101 2GK11QQK					
				NO TEST	(SC147) <u>2.4L 2WD</u> Engine Replacement Only	171A30R2	8.1 M/H	21111 2GK50QQK	1
								21111 2GK70QQK	1
								(AT) 23311 25050	1
								(MT) 23231 25200	
					(12-13MY) 21101 2GK09QQK	1			
(14MY ULEV) 21101 2GK10QQK									
(14MY ULEV or SULEV) 21101 2GK11QQK									
(SC147) <u>2.4L AWD</u> Engine Replacement Only	171A30R3	8.3 M/H	21111 2GK50QQK		1				
			21111 2GK70QQK		1				
			(AT) 23311 25050		1				
			(MT) 23231 25200						
(12-13MY) 21101 2GK09QQK	1								
(14MY ULEV) 21101 2GK10QQK									
(14MY ULEV or SULEV) 21101 2GK11QQK									

SUBJECT: THETA II ENGINE INSPECTION AND/OR REPLACEMENT (SC147)

Model	Claim Type	Causal P/N	Qty.	Test Result	Repair Description	Labor Op Code	Op Time	Replacement P/N	Qty.			
Spo. (SL)	R	23060 2G400	0	PASS	(SC147) Engine Noise Inspection PASS & LOF	17104511	0.7 M/H	26300 35504	1			
								21513 23001	1			
					(SC147) Engine Noise Inspection PASS , Dipstick Replacement, & LOF	17104510	0.7 M/H	26611 2G050QQK	1			
								26300 35504	1			
							NO PASS	(SC147) <u>2.0T-GDI 2WD</u> Engine Noise Inspection NO PASS , & Engine Replacement	171045R0	7.8 M/H	21111 2GK60QQK	1
					21111 2GK70QQK	1						
					(AT) 23311 25050 (MT) 23231 25200	1						
					21101 2GK13QQK	1						
							NO PASS	(SC147) <u>2.0T-GDI AWD</u> Engine Noise Inspection NO PASS , & Engine Replacement	171045R1	8.2 M/H	21111 2GK60QQK	1
					21111 2GK70QQK	1						
					(AT) 23311 25050 (MT) 23231 25200	1						
					21101 2GK13QQK	1						
							NO TEST	(SC147) <u>2.0T-GDI 2WD</u> Engine Replacement Only	171045R2	7.4 M/H	21111 2GK60QQK	1
					21111 2GK70QQK	1						
					(AT) 23311 25050 (MT) 23231 25200	1						
					21101 2GK13QQK	1						
			NO TEST	(SC147) <u>2.0T-GDI AWD</u> Engine Replacement Only	171045R3	7.8 M/H	21111 2GK60QQK	1				
	21111 2GK70QQK	1										
	(AT) 23311 25050 (MT) 23231 25200	1										
	21101 2GK13QQK	1										

NOTE: Refer to Warranty Bulletin 2017-09 for details regarding oil and coolant reimbursement requirements.

Use sublet code 'X1' with a maximum allowed amount of \$16.50 for "**LOF**" engine oil reimbursement.

Use sublet code 'X2' if an engine oil top-off is necessary before performing noise test as outlined in Step 1, with a maximum allowed amount of \$6.60 for two (2) quarts of oil.

Use sublet code 'X3' with a maximum allowed amount of \$19.80 for "**ENGINE R&R**" engine oil reimbursement.

Use sublet code 'RX' for reimbursement of rental expense.

If the replacement of the Oil Cooler Tube Assembly was required, please manually enter the applicable Oil Cooler Tube Assembly part number to the claim's related parts section.

If replacement of any engine related components are needed to complete the inspection in addition to consequential damage from an engine failure, these components should be covered (Warranty or Goodwill) using a separate claim under a new line using the same Repair Order. See Warranty Bulletin 2017-09 for more detailed information on claim submission and processing.

Dispose of old parts in accordance with local, state, and Federal regulations.

*** NOTICE**

VIN inquiry data for this repair is provided for tracking purposes only. Kia retailers should reference SC147 when accessing the WebDCS system.

Appendix 1 (Warranty Claim Authorization)

	Scenario	Description	Action Required
1	Campaign - TSB # SC147 Case for Warranty Authorization TEST- NO PASS	Engine Test Completed – NO PASS R&R Engine	No TL PWA or involvement needed – claim will be auto-approved if a NO PASS test record is received via KDS "Special Inspection" feature.
2	Campaign - TSB # SC147 Case for Warranty Authorization NO TEST	Engine test cannot be completed due to engine seizure or other engine failure (won't run long enough to complete the test)	TL PWA required for all dealers – Video of condition required* Video requirement examples below are for illustration purposes, individual requirements will vary based upon the condition reported: <ul style="list-style-type: none"> • Video should be continuous and show the VIN (most convenient VIN plate) and pan to show the engine condition • For engine seizures, attempt to turn over engine with breaker bar in video • For hole in engine block, show hole in video • For engine smoking condition (piston ring sealing), show smoke in video.
3	Campaign - TSB # SC147 Case for Warranty Authorization TEST PASS- OTHER CONDITION	Engine Test Completed – PASS , but other engine condition requires engine replacement	TL PWA required for all dealers– Video of condition required* <ul style="list-style-type: none"> • The requirements for NO TEST to obtain authorization will apply • The claim should be submitted as NO PASS engine replacement
4	Engine Replacement AFTER SC147 Recall is Completed	Engine Replacement Required but SC147 Inspection already completed from prior visit	TL engine PWA process applies to all dealers regardless of DSA status. <ul style="list-style-type: none"> • Repairs will be performed using SC147 Parts (QOK Engine Part) & Labor Operation code for engine replacement (no test) • Warranty Claim will be submitted under additional campaign SC147A (VIN will be added based upon T L PWA approval)

SUBJECT: THETA II ENGINE INSPECTION AND/OR REPLACEMENT (SC147)

Appendix 2 (Testing the Engine Noise Adapter)

To verify if the SC147 Theta II Engine Inspection and/or Replacement Campaign adapter is detecting and providing input to the KDS Noise Checking feature, a supplemental app may be downloaded from the Play Store to ensure the adapter is operating. Follow the procedure below to validate the engine noise adapter. Note: connecting the adapter to a PC will not produce valid results.

1. Select the "Play Store" on the tablet.

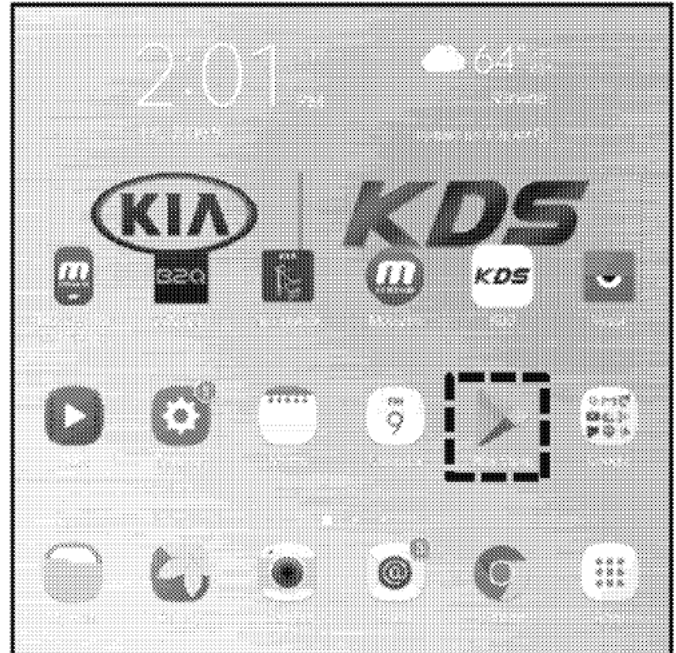

2. Search for "Sound Record" and select "Easy Sound Recorder".

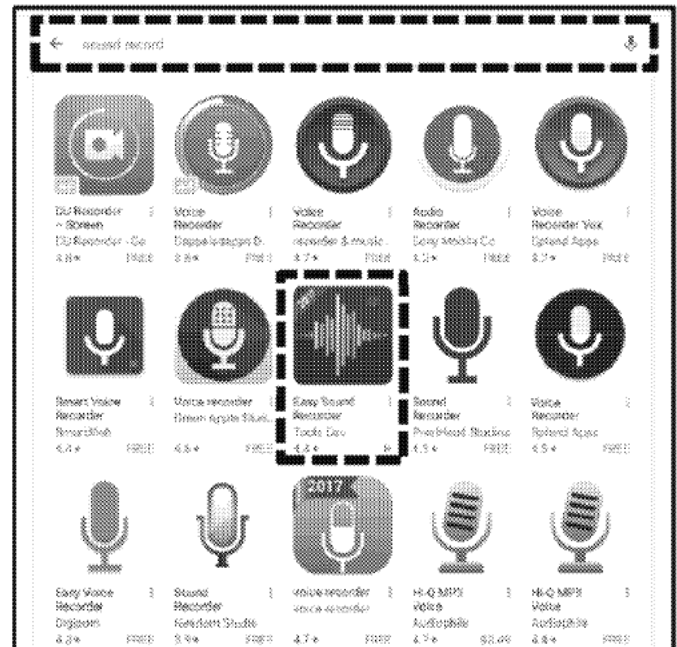

SUBJECT: THETA II ENGINE INSPECTION AND/OR REPLACEMENT (SC147)

3. Install and open the "Easy Sound Recorder" app.

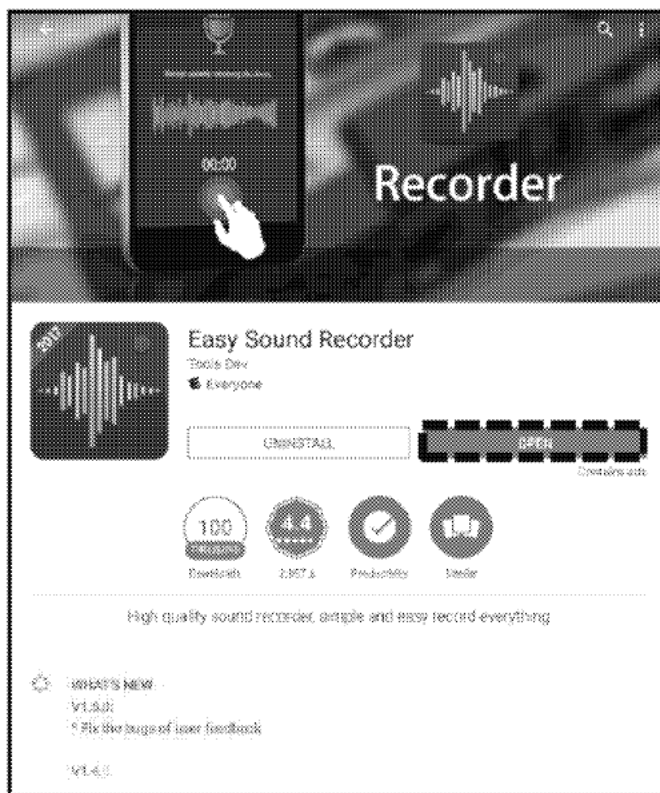

4. Ensure the adapter is connected to the tablet, select the red dot to start the recording.

Tap the dipstick end of the tool on a table.

The waveform should be similar to the image.

For assistance, contact GIT America at (888) 542-4371.

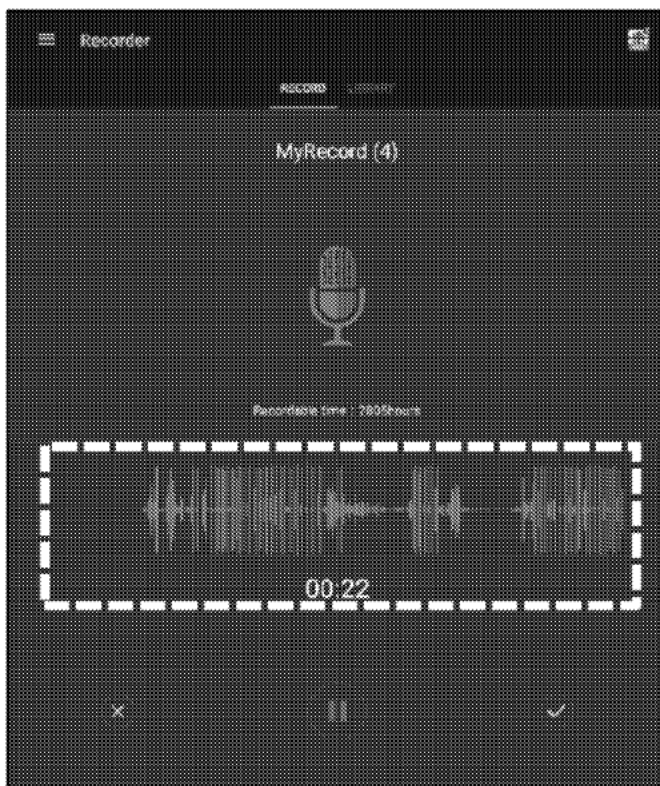

Appendix 3 (Video Capture & Upload)

Capturing a video is often helpful in assisting the Kia Techline Agent in determining a proper diagnosis strategy. Once a TechLine case is open, the following procedure will guide you through the video capture and upload.

The Chrome™  browser should be used to access the Techline portal. Follow the steps below to clear the default browser if it is other than Chrome™.

For KDS Tab 10.1 Tablets:

1. Select "Settings" from the App Screen.
2. Select the "General" tab at the top.
3. Select "Default Applications".
4. If "Internet" is the default browser, select the CLEAR button.
If "Chrome" is the default browser, further action is not required.

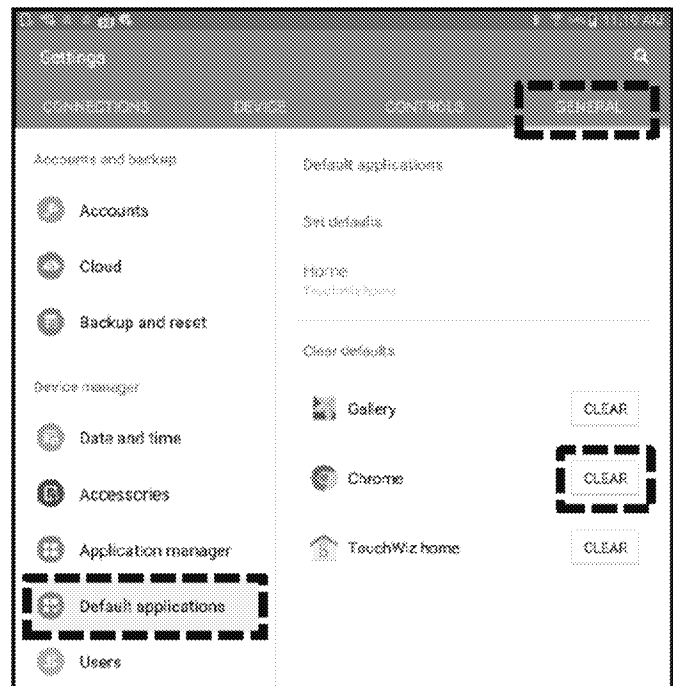

5. When opening the Techline portal, select "Chrome" and select Always".

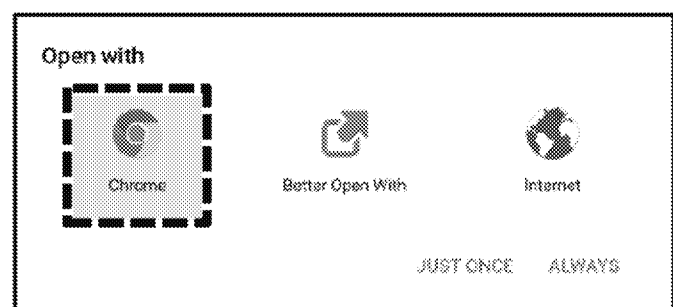

SUBJECT: THETA II ENGINE INSPECTION AND/OR REPLACEMENT (SC147)**For KDS Tab S2 Tablets:**

1. Select "Settings" from the App Screen.
2. Select "Applications".
3. Select "Default Applications".

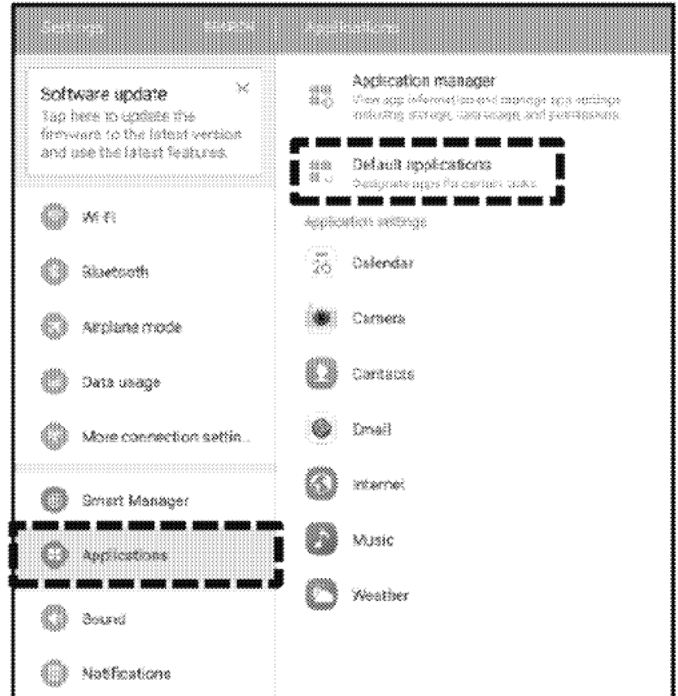

4. Select "Browser app".

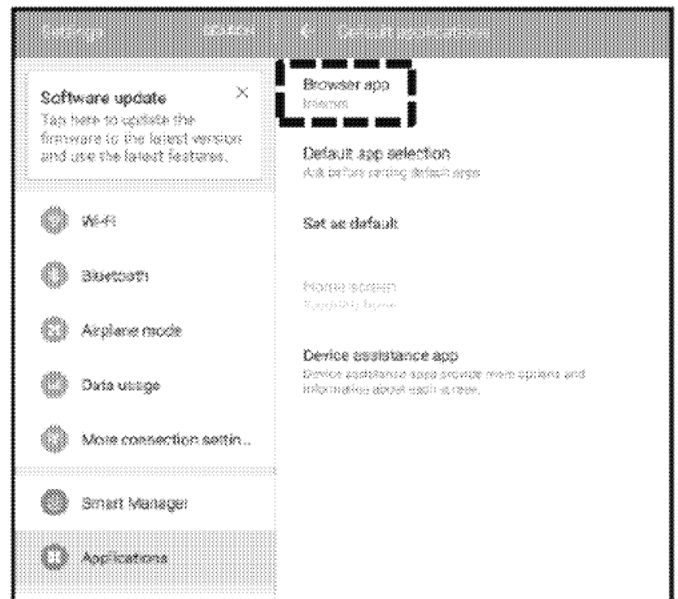

5. Ensure "Chrome" is selected.

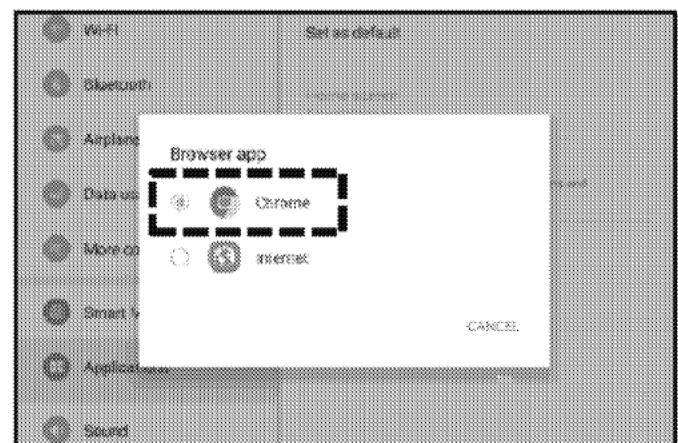

SUBJECT: THETA II ENGINE INSPECTION AND/OR REPLACEMENT (SC147)
Setting Your Video Size to “Limit to Email”

1. Select “Camera” from the App Screen.

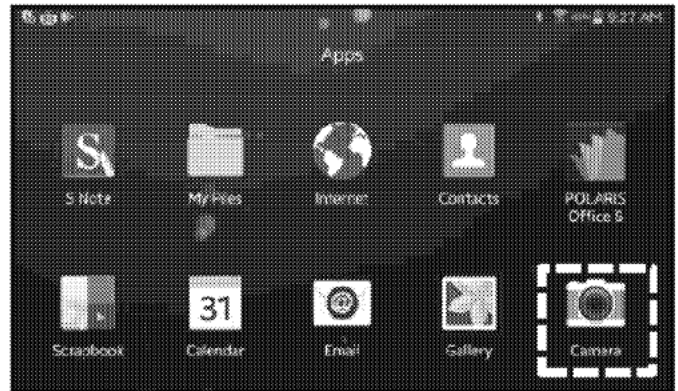

2. Select the Settings icon.

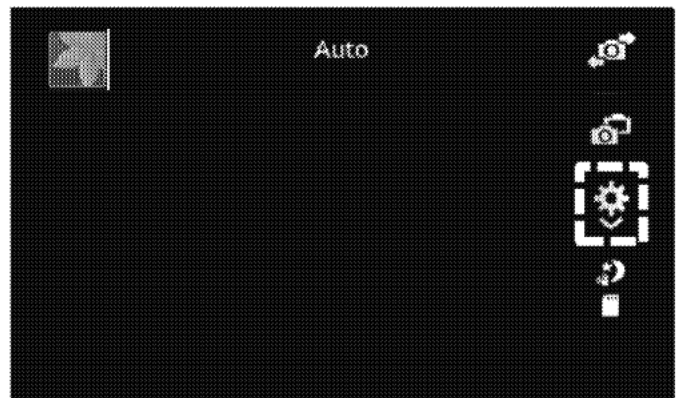

3. Select the Video Camera icon.



4. Ensure “Limit to email” is selected.



Attaching Video to a Techline Case

1. Open K-Support in the device Chrome™ browser or select the “Techline” button on KDS home page.

<https://ksupport.kiausa.com>

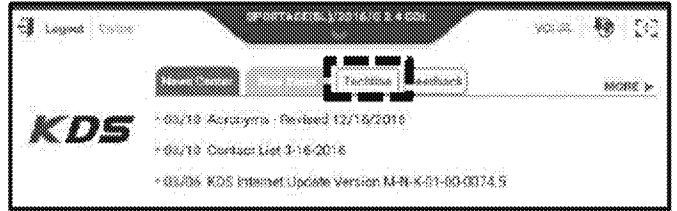

2. Open your existing Techline case for the vehicle requiring a video capture by selecting the case number.

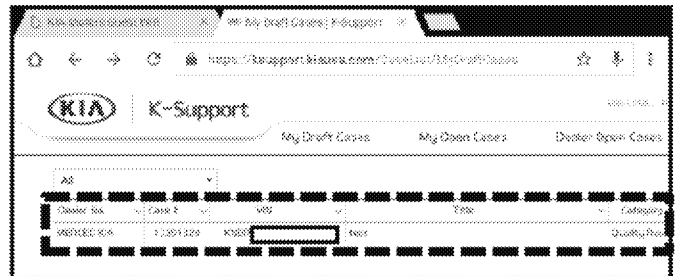

3. Select “Attachment”.

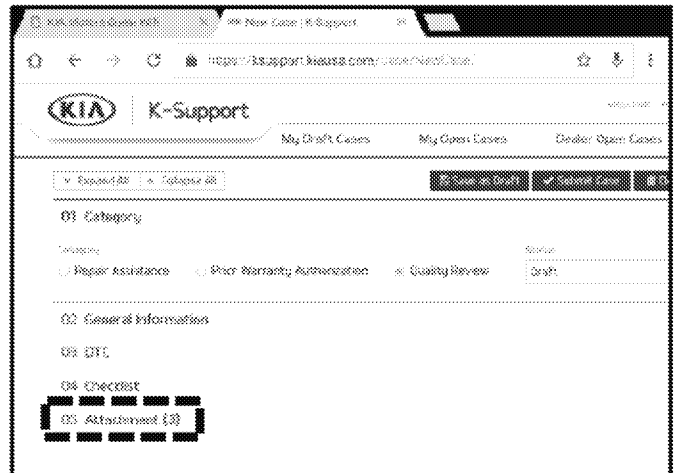

4. Select “Add Files”.

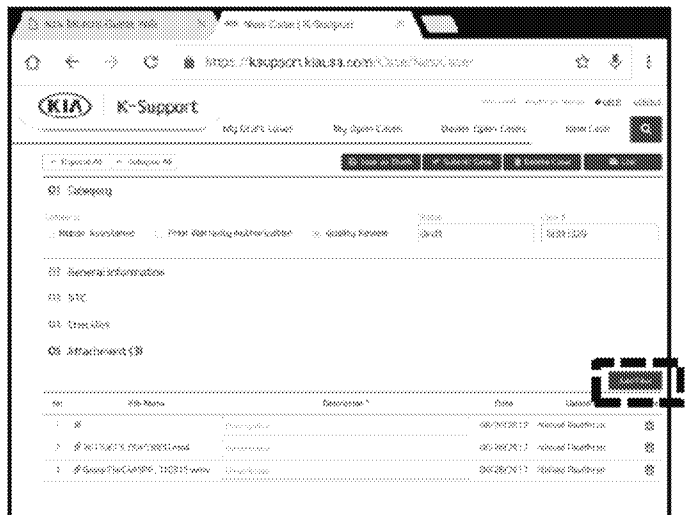

5. Select “Camcorder” and the video camera will open.

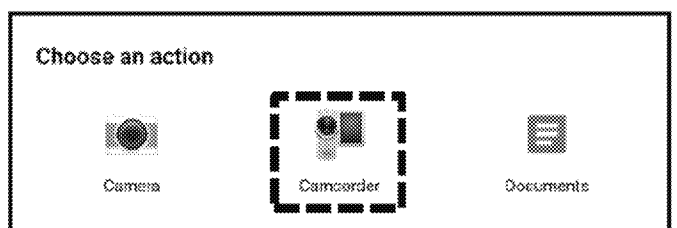

SUBJECT: THETA II ENGINE INSPECTION AND/OR REPLACEMENT (SC147)

- Start by recording the VIN. Ensure sun glare is not reflecting off windows or other objects.

Without stopping the recording, capture the area of the vehicle displaying the issue. i.e.;

- Engine Noise – record the engine.
- Smoking – record smoke at the exhaust.
- Hole In Block – record the side of the engine with the damage.
- Seized Engine – record a technician trying to turn the engine over with a breaker bar.

NOTE: Ensure the video size is set to “Limit to email”.

- Stop the video when you captured what is needed. Select “OK” to use this capture or “RETRY” to capture the video again.

- Ensure a description of the recording. For example, engine knock or smoke from exhaust.

- Select “Submit Case”.

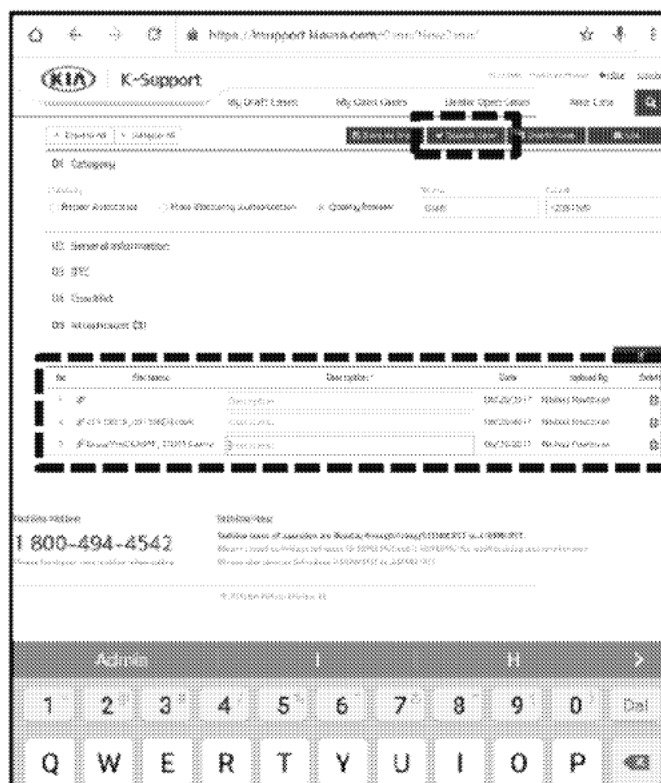
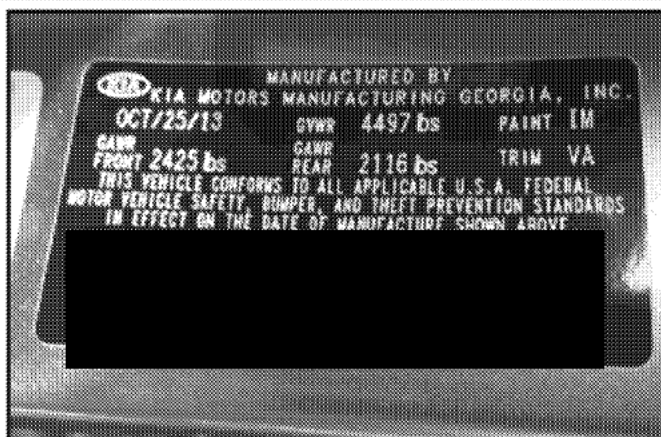

10. Select "Yes" when the confirmation message below appears.

Note: Selecting anything other than "Yes" will not save the video capture.

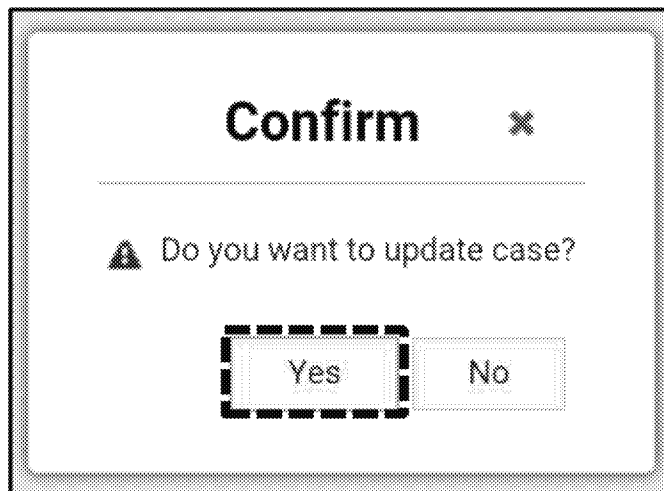

SUBJECT: THETA II ENGINE INSPECTION AND/OR REPLACEMENT (SC147)

Appendix 4 (Engine Noise Adapter Threshold)

Code	Concern	Action
RETEST Code 001	Any measured value out of range / below lower limit	Contact GIT America
RETEST Code 002	Any measured value out of range / over upper limit	Contact GIT America
RETEST Code 003	Difference between minimum and maximum of 2000 RPM <u>or</u> Idle RPM measured value out of range	Perform Retest three (3) more times. If Error Code 003 still displays after the third attempt, contact GIT America.
RETEST Code 004	Difference between minimum and maximum of 2000 RPM <u>and</u> Idle RPM measured value out of range	Perform Retest three (3) more times. If Error Code 004 still displays after the third attempt, contact GIT America.
RETEST Code 005	The adapter/extension cable is unplugged or damaged after test started	Perform Retest three (3) more times. If Error Code 005 still displays after the third attempt, contact GIT America.

GIT America can be contacted at (888) 542-4371.