

## #18-NA-073: Repair Guidelines for Engine Component Wear - (Jan 18, 2022)

**Subject: Repair Guidelines for Engine Component Wear**



Brand:	Model:	Model Year:		VIN:		Engine:	Transmission:
		from	to	from	to		
GM Passenger Cars and Trucks		2015	2022	All	All	All	—

<b>Involved Region or Country</b>	North America, Europe, Russia, Uzbekistan, Middle East, Iraq, Israel, Palestine, Argentina, Brazil, Bolivia, Chile, Colombia, Ecuador, Paraguay, Peru, Uruguay, Venezuela, Japan, Cadillac Korea (South Korea), GM Korea Company, China, Taiwan, Thailand, Singapore, Philippines, Egypt, Other Africa, South Africa
<b>Condition</b>	Whenever engines have been disassembled, technicians may encounter some visible engine wear characteristics on critical engine components. Some technicians may be replacing engines instead of repairing and replacing worn components as needed.
<b>Cause</b>	These conditions may be caused by the vehicle duty cycle, dust in the environment the vehicle is being operated in and local fuel quality. In some instances, service personnel may be improperly diagnosing normal engine wear.
<b>Correction</b>	Review the following graphic examples and information in this bulletin.

### Information

The purpose of this bulletin is to assist the service personnel with graphics and information to use as guidelines in order to perform the necessary engine repairs and prevent unnecessary engine replacement.

**Important:** Prior to component replacement: Refer to SI to diagnose and identify the root cause of the original failure. In cases involving suspected bearing failure, remove and inspect the oil filter. Refer to the Oil Filter – Inspect for Excessive Debris section in this bulletin.

**Important:** Prior to completing repairs, do a cost analysis; in some instances, an engine replacement may be considered.

**Important:** If SI diagnosis leads to an inspection of the cylinder bores and reveals cylinder wall damage (i.e. excessive scoring or out-of-round), an engine replacement may be required. Refer to the Cylinder Bore section in this bulletin.

### Camshaft

Review the following:

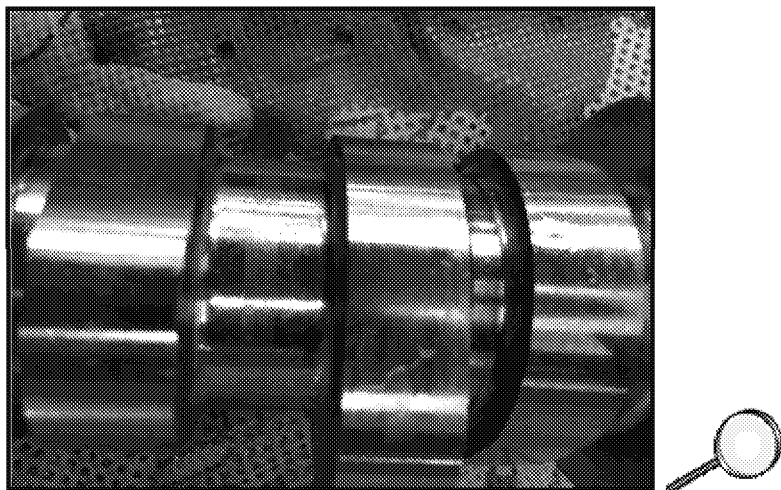

Example of minor scratching/scoring visible on camshaft lobes and/or camshaft bearing journals. In this example, the scored components can be replaced without need for engine assembly replacement.

### Camshaft Bearing Caps

Review the following:

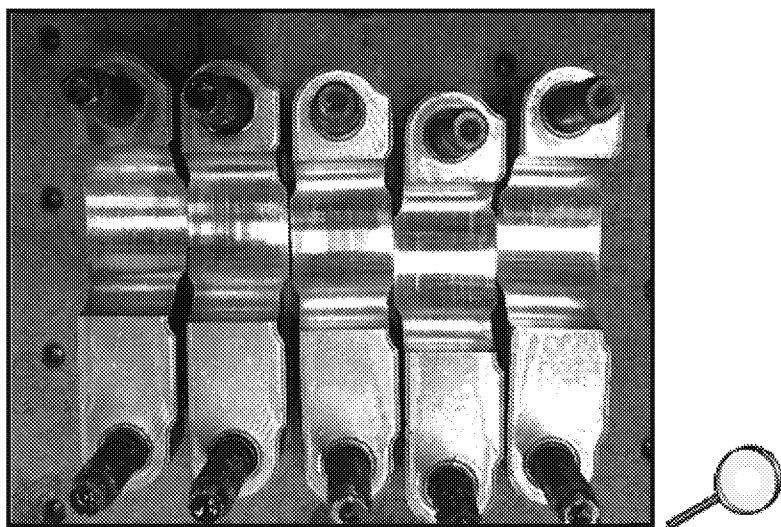

Example of minor scratching/scoring visible on camshaft bearing caps. In this example, the scored components can be replaced without need for engine assembly replacement.

### Connecting Rod End Caps and Bearings

Review the following:

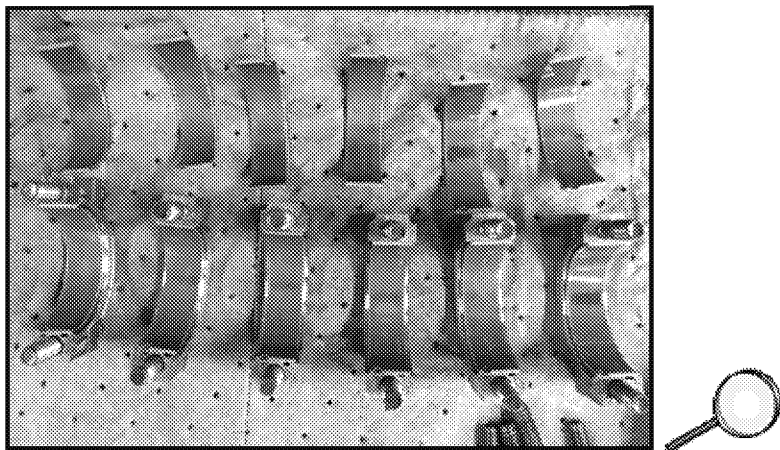

Example of minor scratching/scoring visible on connecting rod bearings. In this example, the scored components can be replaced without need for engine assembly replacement.

### **Crankshaft in Crankcase**

Review the following:

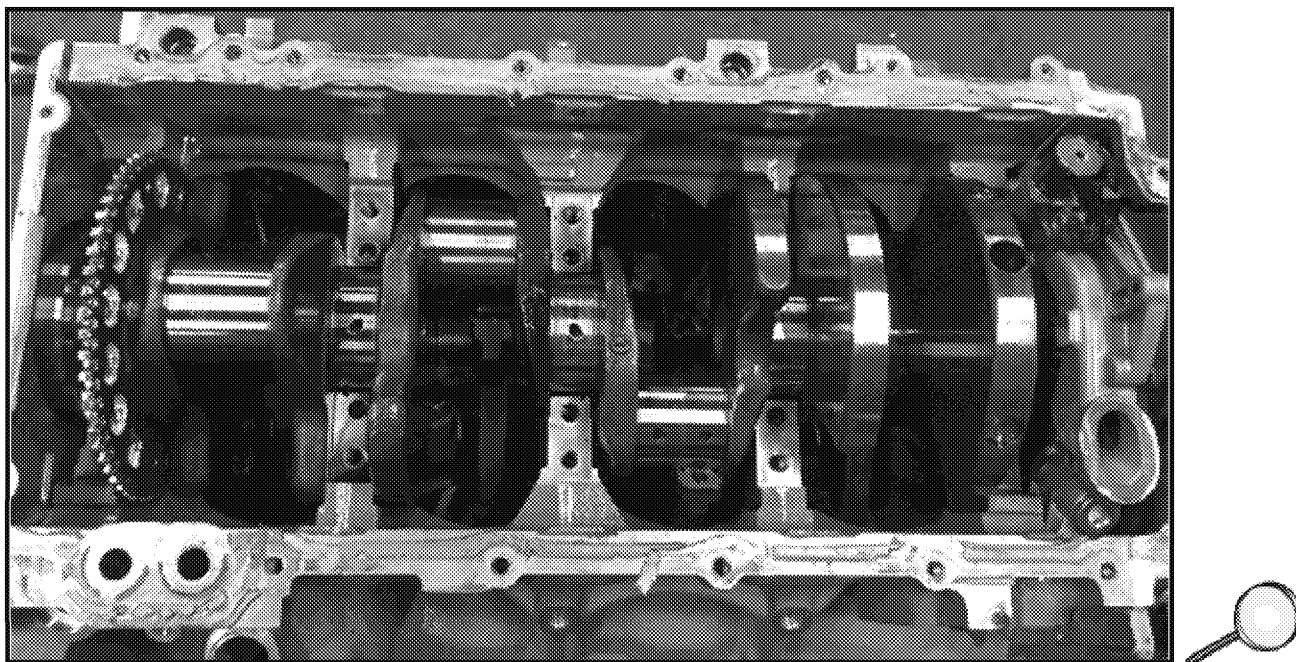

Example of minor scratching/scoring visible on crankshaft. In this example, the scored components can be replaced without need for engine assembly replacement.

### **Crankshaft Main Bearings and Journal**

Review the following:

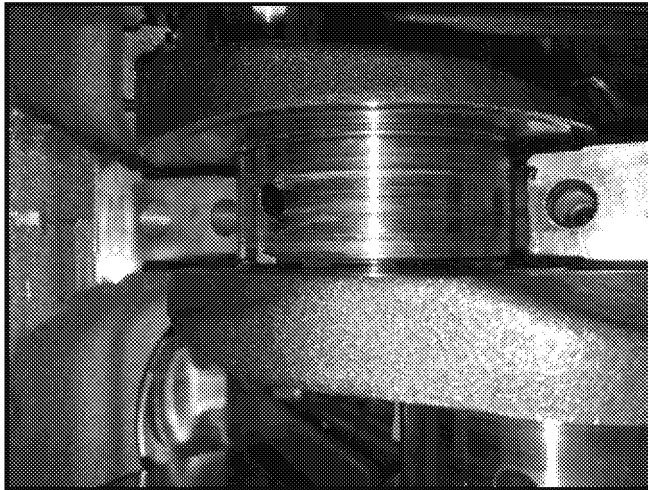
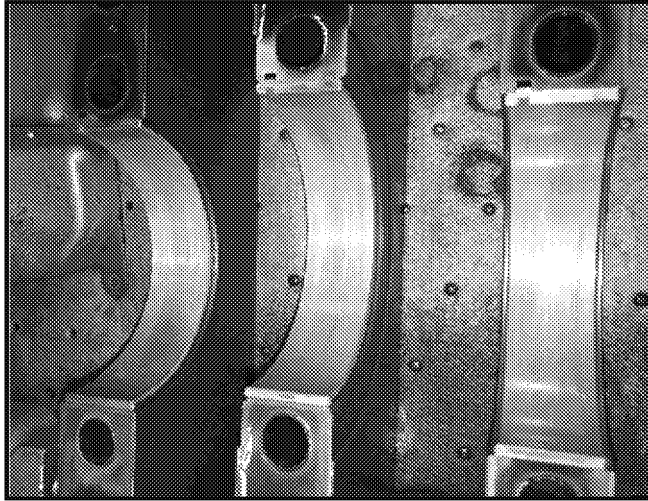

Example of minor scratching/scoring visible on crankshaft. In this example, the scored components can be replaced without need for engine assembly replacement.

**Crankshaft, Reluctor Ring and Journal**

Review the following:

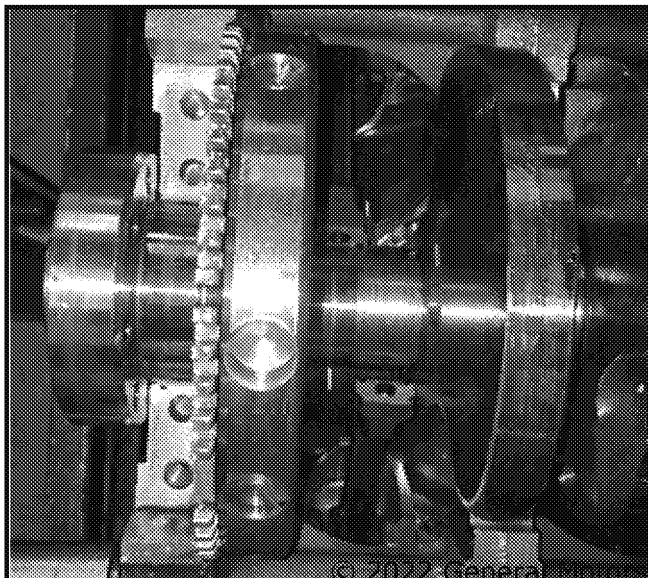

© 2012 General Motors. All rights reserved.

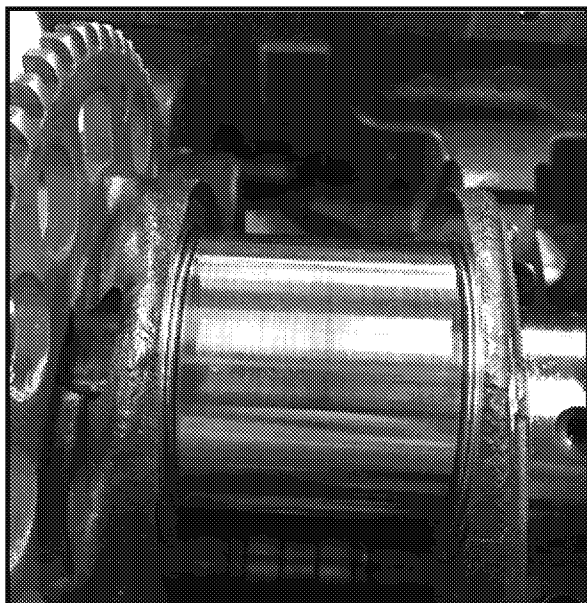

Example of minor scratching/scoring visible on crankshaft. In this example, the scored components can be replaced without need for engine assembly replacement.

### **Cylinder Bore**

Review the following:



© 2022 General Motors. All rights reserved.

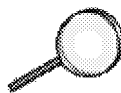

Example of minor scratching/scoring visible on cylinder wall. In this example, if you cannot catch a pick or fingernail on the scratch, the cylinder bore/engine block does not require replacement. If the piston is slightly scored, the scored piston can be replaced without need for engine assembly replacement.

### **Cylinder Out-of-Round**

Review the following:

Suspecting an engine block of possible cylinder bore damage, scoring or out of round as the possible cause of engine oil consumption, misfire, cylinder leakage or blow by.

**Note:** The peak to valley suspecting an engine block of possible cylinder bore damage, scoring or out of round as the possible cause of engine oil consumption, misfire, cylinder leakage or blow by. spec for crosshatch is .65-2.8 microns. Any deviation and the crosshatch will be gone even if a cylinder is suspected of being oversize, we can only confirm that by checking with an air gauge at the engine plant.

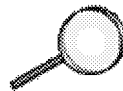
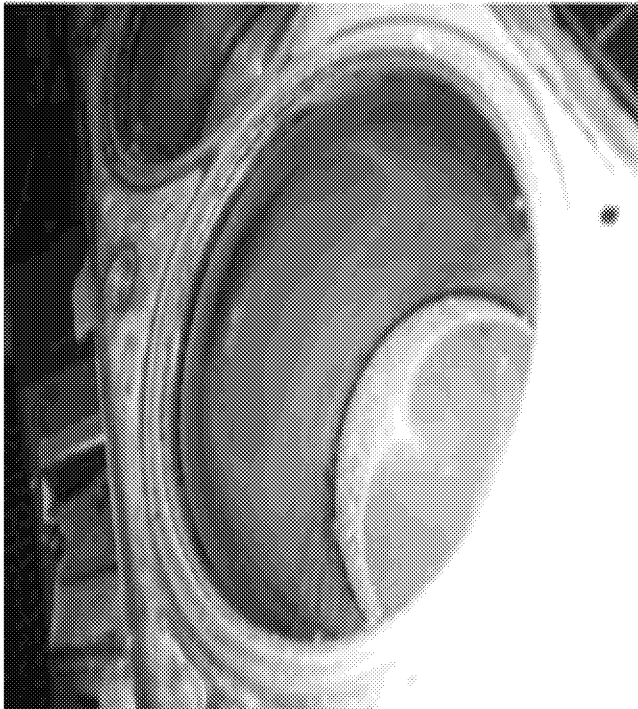

When inspecting the engine block to determine if the cylinder bores are good, look for the following:

1. Cylinder damage or scoring – The cylinder walls will contain grooves deep enough to catch with a fingernail.

2. Out of round cylinder bore – Contains areas where the crosshatch is missing or worn from different sections of the cylinder bore. If there is crosshatch all the way around the bore from top to bottom, the cylinder bore is not out of round.
3. Dirt intrusion – If the filtering system has been compromised, the engine will wear out very quickly. You will find grit in the intake runners and the cylinder bores will look lightly sand blasted. The crosshatch will be faint and there will not be sharpness. At high mileage this may not be Warrantable if the air filtering system has been opened numerous times for service in dusty climates.
4. Catalytic converter failure – If a converter fails and the brick is broken, the dust can be drawn back into the engine. A block showing this type of failure will have bores that look to be sand blasted. Back cylinders go first if caught early. Otherwise there will be no crosshatch and the engine will need to be replaced.

### Cylinder Bore Honing Marks

Review the following:

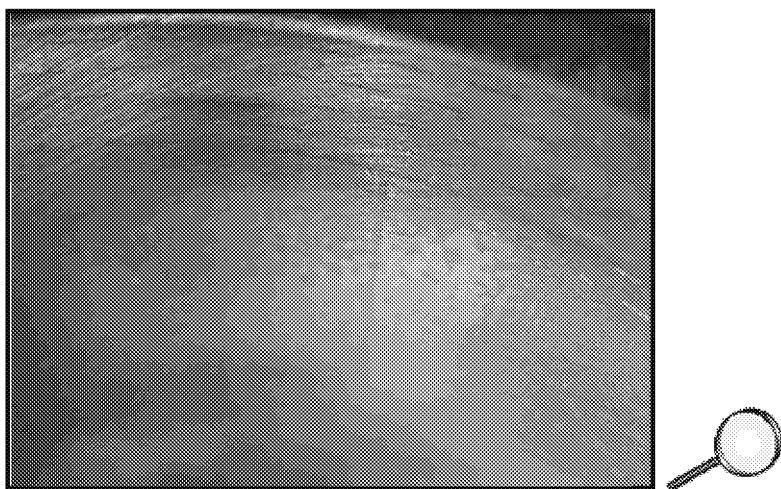
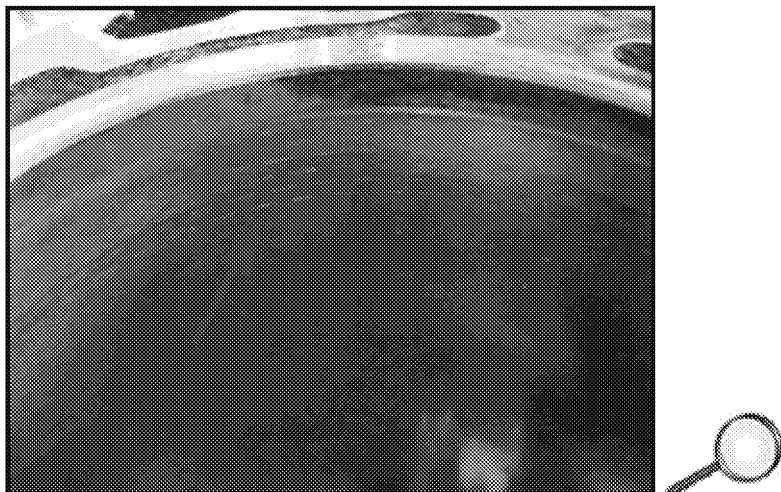

Some technicians may be replacing entire engine assemblies due to marks found at the top of the cylinder bore. These marks are considered normal and are left as a result of a manufacturing laser honing process. **DO NOT** replace the cylinder block or the engine for these normal laser honing marks (refer to PI0725B).

### Piston

Review the following: © 2022 General Motors. All rights reserved.

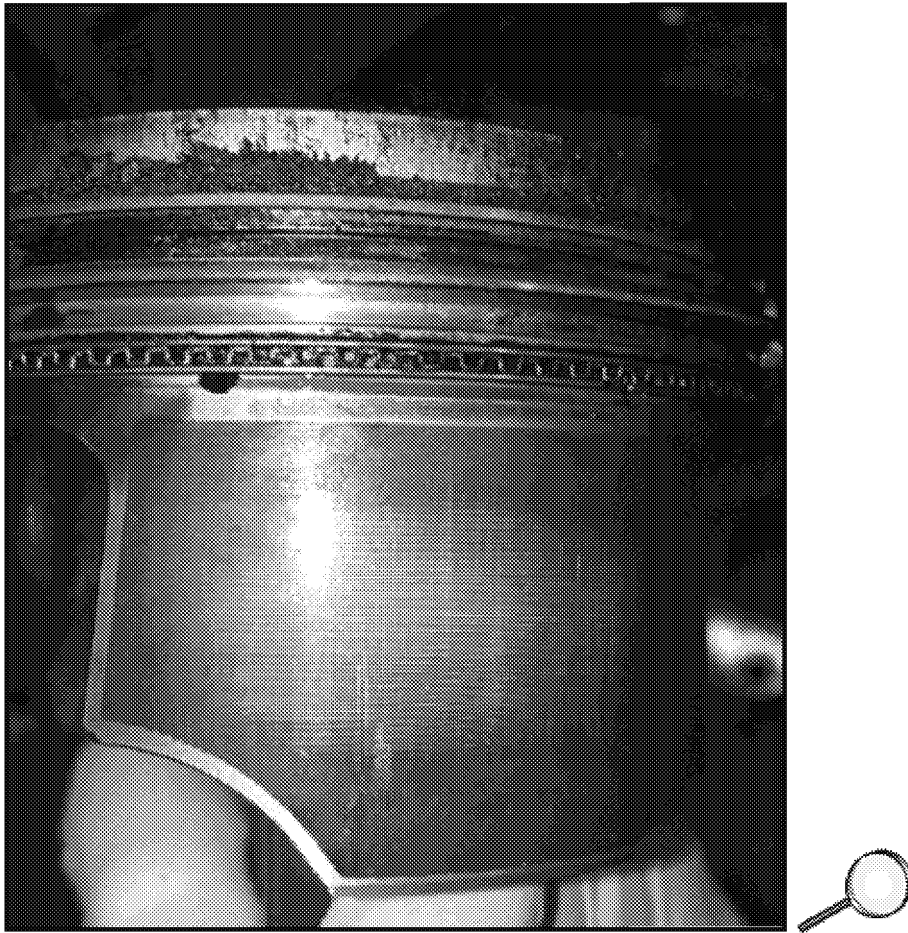

Example of minor scratching/scoring visible on piston. In this example, inspect for broken and/or stuck rings and piston ring lands and cylinder wall for damage. If no cylinder wall damage or other significant damage, components can be replaced without requiring an engine assembly replacement.

#### Oil Filter — Inspect for Excessive Debris

In cases involving suspected bearing failure, remove and inspect the oil filter for excessive debris and damaged pleats. Use the inspection as an indicator of the amount of material that is displaced through the engine and lubrication circuits. This may help to avoid unnecessary engine removal.

Review the following:

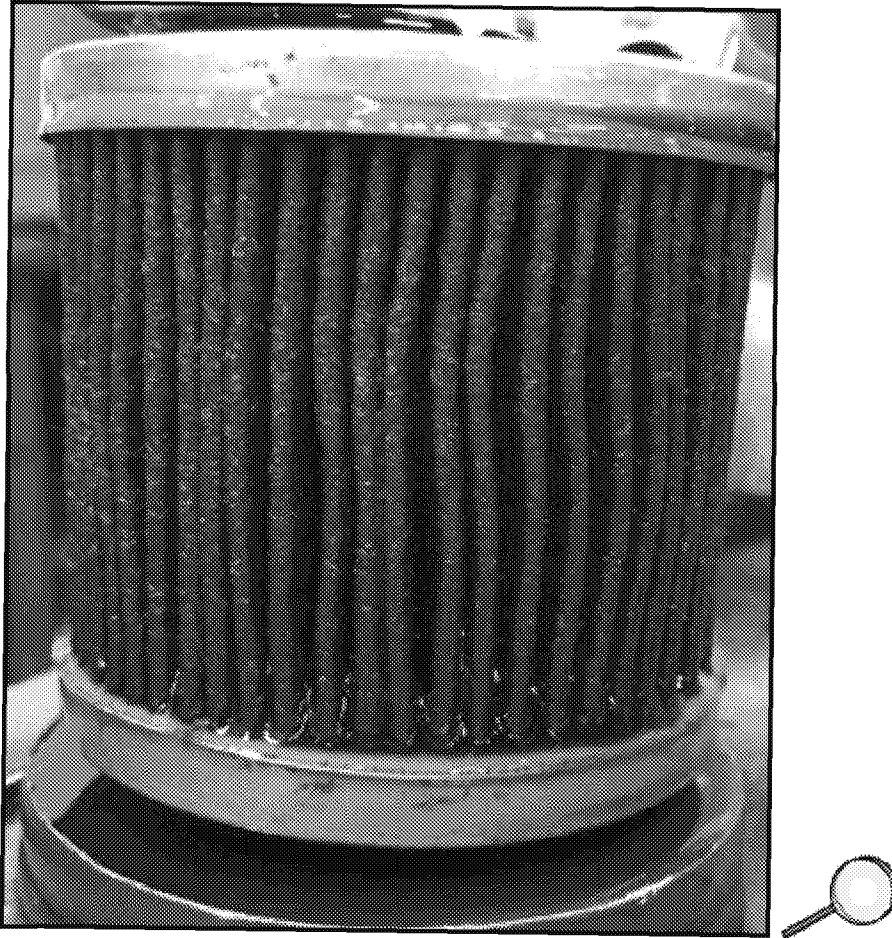

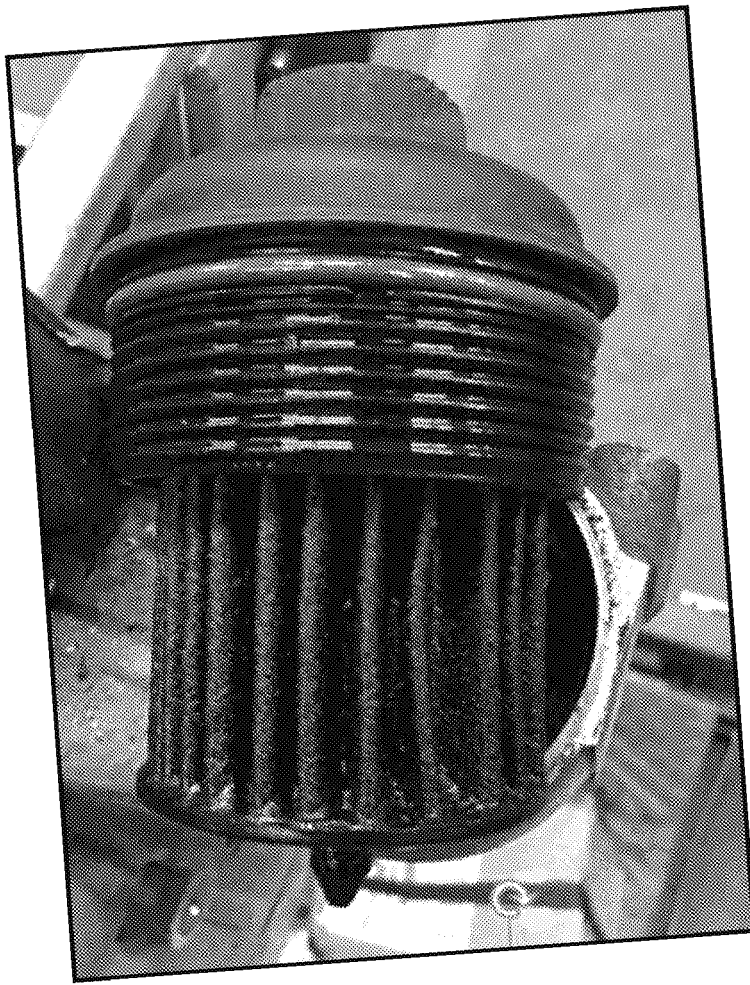

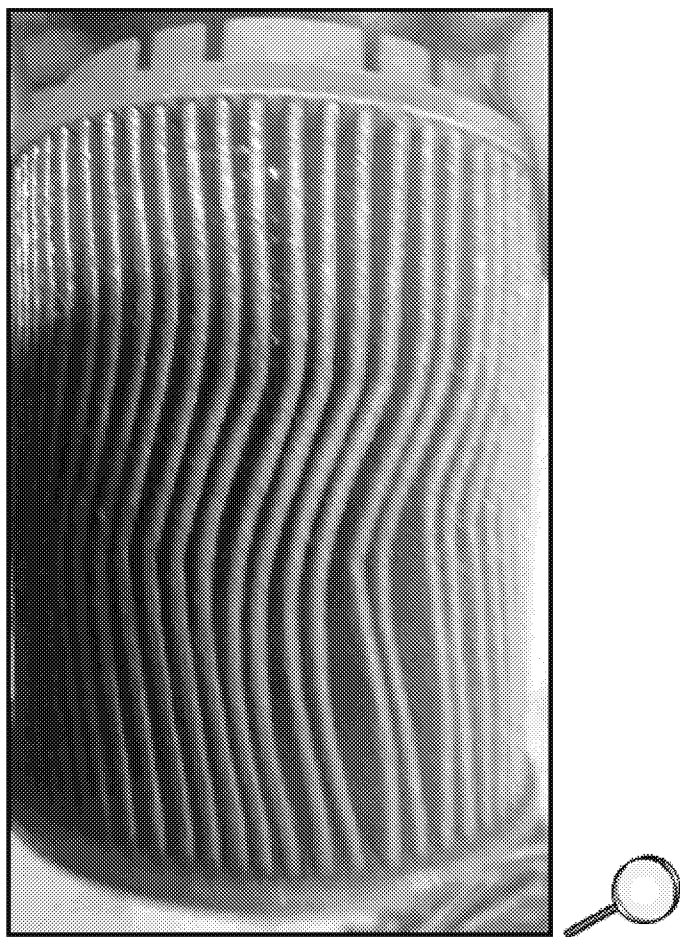

Shown are oil filter pleats with visible metal particles.

In this example, minimal amounts of metal particles are visible on oil filter pleats and should not pose a concern.

If excessive amounts of metal particles are observed, or if there is evidence of damaged oil filter pleats, then unfiltered oil with bearing debris may have been pumped into the oil lubrication galleries throughout the engine. This will require further inspection to confirm the degree of contamination and appropriate repair direction. Refer to Service Bulletin #19-NA-256 for HFV6 Gen 1 and Gen 2.

Version Information

<b>Version</b>	7
<b>Modified</b>	<p>Released March 07, 2018</p> <p>February 07, 2020 – Added the 2020 Model Year, updated the Involved Region or Country section, updated some PI references and changed the bulletin reference in the Oil Filter – Inspect for Excessive Debris section.</p> <p>January 22, 2021 – Added the 2021 Model Year and updated Involved Region or Country section.</p> <p>April 13, 2021 – Added a graphic under Cylinder Bore section, added Cylinder Out-of-Round section and updated the PI reference under Information and Cylinder Bore sections.</p> <p>July 27, 2021 – Removed references to PIP5163E and changed the word toothpick to pick under Cylinder Bore section.</p>

© 2022 General Motors. All rights reserved.

August 06, 2021 – Removed Australia/New Zealand from the Involved Region or Country section.  
January 18, 2022 – Added the 2022 Model Year.

GM bulletins are intended for use by professional technicians, NOT a "do-it-yourselfer". They are written to inform these technicians of conditions that may occur on some vehicles, or to provide information that could assist in the proper service of a vehicle. Properly trained technicians have the equipment, tools, safety instructions, and know-how to do a job properly and safely. If a condition is described, DO NOT assume that the bulletin applies to your vehicle, or that your vehicle will have that condition. See your GM dealer for information on whether your vehicle may benefit from the information.



WE SUPPORT  
VOLUNTARY  
TECHNICIAN  
CERTIFICATION