

Along Ada Co

Enterprise

Rental Agreement Summary

BAR 303EXR
 Renter: MANUEL YANES

Dates & Times

Location

Pick up

Wednesday, September 12, 2018 6:18 PM 16800 NW 57TH AVE
 Start Charge: MIAMI, FL 33015-4328
 Wednesday, September 12, 2018 6:18 PM (305) 558-3982

Anticipated Return

Thursday, September 13, 2018 5:00 PM 16800 NW 57TH AVE
 MIAMI, FL 33015-4328
 (305) 558-3982

Vehicle

2017 FORD EXEL LANA BLACK License: [REDACTED]
 VIN: 1FMDK2AT9H [REDACTED] Vehicle: [REDACTED]
 Package: [REDACTED] ODO:46645Fuel:7/8
 09/12/2018 @ 6:18 PM

Vehicle Condition:

-PASSENGER REAR DOOR -SCRATCH -DRIVER FENDER -
 SCRATCH -REAR BUMPER -SCRATCH -DRIVER QUARTER
 PANEL -SCRATCH -PASSENGER FENDER -SCRATCH

Summary of Charges

Estimated Bill-To

AUTONATION FORD MIAMI-SRV 57TH
 Reference: 506401
 Pcp:100.0%

Charges	Price/Unit	Total
---------	------------	-------

TIME & DISTANCE	\$99.25 / Day	\$99.25
9/12/18-9/13/18		
VEHICLE LICENSE FEE RECOVERY	\$0.75 / Day	\$0.75
SALES TAX (7%)	7%	\$0.00
Subtotal		(\$60.00)

Estimated Renter Charges

Charges	Fees/Link	Total
NO CHARGE DISTANCE	\$0.00 / Mile	\$0.00
9/12/18-9/13/18		
RETURNING CHARGE	\$4.06 / Gal/mi	\$0.00

Optional Protections Accepted

DW	\$21.99 / Day	\$21.99
----	---------------	---------

Optional Protections Declined

SUPPLEMENTAL LIABILITY PROTECTION	1 @ \$17.99 / Day	\$0.00
ROADSIDE ASSISTANCE PROTECTION	1 @ \$5.99 / Day	\$0.00
PERSONAL ACCIDENT INSUR/ERECTS CVG	1 @ \$6.30 / Day	\$0.00

Renter Acknowledgment of Accepted and Declined Protections
 I acknowledge that I have accepted or declined protections as indicated above.

Total Estimated Charge: \$21.99

Psychic:

VIS: [REDACTED] Auto (575.00)

Rent

I acknowledge that I have reviewed and agree to all Estimated Renter Charges and fees listed on Summary of Charges and further agree to pay for final charges in accordance with the Terms and Conditions of this Rental Agreement.

PERMITS STATE OF FLORIDA
 FL ONLY NO PETS/SMOKING
 OPERATION IN ANY OTHER STATE OR COUNTRY WILL AFFECT YOUR LIABILITY AND RIGHTS UNDER THIS AGREEMENT.

Owner: ENTERPRISE LEASING COMPANY OF FLORIDA, LLC

Additional Drivers

No Additional Drivers are authorized to drive the vehicle with the exception of the drivers listed below.
 (Additional driver names listed here if applicable)

Please keep this Rental Agreement Summary with you in the vehicle during the rental.

Local Addenda

Failure to return rental property or equipment upon expiration of the rental period and failure to pay all amounts due (including costs for damage to the property or equipment) are evidence of abandonment or refusal to redeliver the property, punishable in accordance with section 812.155 and/or section 817.55 of the Florida Statutes.

SC REC IS THE FLORIDA STATE RENTAL CAR SUBCHARGE.
 SEE RENTAL AGREEMENT JACKET PARAGRAPH 3.B.A.

VLP REC IS THE VEHICLE LICENSE FEE RECOVERY. SEE RENTAL AGREEMENT JACKET PARAGRAPH 3.B.A.

Henson Ada Brown

ENTERPRISE LEASING COMPANY, 16800 NW 57TH AVE, MIAMI, FL 330154328 (305) 558-3982

RENTAL AGREEMENT REF#
[REDACTED] 3L1RF9

DATE & TIME OUT
09/24/2018 09:14 AM
DATE & TIME IN
09/25/2018 11:00 AM

BILLING CYCLE
24-HOUR

CAR CLASS CHARGED
FCAR

VEH #1 2018 FORD F15C 6LT2
VIN# 1FTEW1CB3JP [REDACTED]
LIC# [REDACTED]
MILES DRIVEN 50
CAR CLASS: PPAR

BILL TO ACCOUNT
AUTONATION FORD MIAMI-SRV 57TH
ATTN: RODRIGUEZ, OTTO
16800 NW 57TH AVE.
MIAMI, FL 33015

CLAIM INFO
[REDACTED]
TYPE CAR: EXPLORER
SHOP: AUTONATION FORD MIAMI-SRV 57TH
PHONE: (305) 557-5580
ATTN: RODRIGUEZ, OTTO

SUMMARY OF CHARGES

Charge Description	Date	Quantity	Per	Rate	Total
TIME & DISTANCE	09/24 - 09/25	1	DAY	\$29.25	\$29.25
DW	09/24 - 09/25	1	DAY	\$21.99	\$21.99
REFUELING CHARGE	09/24 - 09/25				\$0.00
Subtotal:					\$51.24
Taxes & Surcharges					
VEHICLE LICENSE FEE RECOVERY	09/24 - 09/25	1	DAY	\$0.75	\$0.75
Total Charges:					\$51.99
Bill-To / Deposits					
AUTONATION FORD MIAMI-SRV 57TH					
TIME & DISTANCE	09/24 - 09/25	1	DAY		
VEHICLE LICENSE FEE RECOVERY	09/24 - 09/25	1	DAY		
Subtotal:					(\$30.00)
DEPOSITS					(\$21.99)
Total Estimated Amount Due					\$0.00

PAYMENT INFORMATION
AMOUNT PAID TYPE
\$21.99 Visa

CREDIT CARD NUMBER
[REDACTED]

Atencio Ada Brown

(5)



Rental Agreement Summary

RA#: [Redacted]
Rental: [Redacted]

Dates & Times Location

Pick up

Monday, September 24, 2018 9:14 AM 16800 NW 57TH AVE
Start Charges: MIAMI, FL 33015-4328
Monday, September 24, 2018 9:14 AM (305) 558-3982

Anticipated Return

Wednesday, September 26, 2018 9:00 AM 16800 NW 57TH AVE
MIAMI, FL 33015-4328
(305) 558-3982

Vehicle

2018 FORD F15C 6LT2 SILVER License: [Redacted]
VIN: 1FTEW1CB3JFC [Redacted] Veh: [Redacted]
Pickup: 09/24/2018 @ 9:14 AM ODO:18229 Fuel:EMPTY

Vehicle Condition:

-OTHER EXTERIOR -OTHER BED LINER

Summary of Charges

Estimated Bill-To

AUTONATION FORD MIAMI-SRV 57TH
Reference: 936495
Pay:100.0%

Charges	Price/Unit	Total
TIME & DISTANCE 9/24/18-9/26/18	\$29.25 / Day	\$58.50
VEHICLE LICENSE FEE RECOVERY	\$0.75 / Day	\$1.50
SALES TAX (7%)	7%	\$0.00
Subtotal		(\$60.00)

Estimated Renter Charges

Charges	Price/Unit	Total
NO CHARGE DISTANCE 9/24/18-9/26/18	\$0.00 / Mile	\$0.00
REFUELING CHARGE	\$4.46 / Gallons	\$0.00

Optional Protections Accepted

DW	\$21.99 / Day	\$43.98
----	---------------	---------

Optional Protections Declined

PERSONAL ACCIDENT INS/EFFECTS CVG	2 @ \$6.30 / Day	\$0.00
--------------------------------------	------------------	--------

SUPPLEMENTAL LIABILITY PROTECTION	2 @ \$17.95 / Day	\$0.00
ROADSIDE ASSISTANCE PROTECTION	2 @ \$5.99 / Day	\$0.00

Renter Acknowledgement of Accepted and Declined Protections

I acknowledge that I have accepted or declined protections as indicated above.

Total Estimated Charge: \$43.98

Payments:

VISA *****4540 Auth (\$75.00)

Renter Acknowledgement of Charges

I acknowledge that I have reviewed and agree to all Estimated Renter Charges and fees listed on Summary of Charges and further agree to pay for final charges in accordance with the Terms and Conditions of this Rental Agreement.

PERMISSION GRANTED TO OPERATE VEHICLE ONLY IN THE STATE OF RENTAL AND THE FOLLOWING STATE(S):

FL ONLY NO PETS/SMOKING

OPERATION IN ANY OTHER STATE OR COUNTRY WILL AFFECT YOUR LIABILITY AND RIGHTS UNDER THIS AGREEMENT.

Owner: ENTERPRISE LEASING COMPANY OF FLORIDA, LLC

Additional Drivers

No Additional Drivers are authorized to drive the vehicle with the exception of the drivers listed below.
(Additional driver names listed here if applicable)

Please keep this Rental Agreement Summary with you in the vehicle during the rental.

Local Addenda

Failure to return rental property or equipment upon expiration of the rental period and failure to pay all amounts due (including costs for damage to the property or equipment) are evidence of abandonment or refusal to redeliver the property, punishable in accordance with section 812.155 and/or section 817.52 of the Florida Statutes.

SC REC IS THE FLORIDA STATE RENTAL CAR SURCHARGE. SEE RENTAL AGREEMENT JACKET PARAGRAPH 3.B.8.

VLF REC IS THE VEHICLE LICENSE FEE RECOVERY. SEE RENTAL AGREEMENT JACKET PARAGRAPH 3.B.8.

*Atencion
Ada Brown*

5

9/24/18 at 9:24 AM

The valid and collectible liability insurance and personal injury protection insurance of any authorized rental or leasing driver is primary for the limits of liability and personal injury protection coverage required by Florida Statute Section 324.021(7) and Florida Statute Section 627.736.

OPTIONAL PRODUCTS NOTICE: WE OFFER FOR AN ADDITIONAL CHARGE THE FOLLOWING OPTIONAL PRODUCTS: DAMAGE WAIVER; PERSONAL ACCIDENT INSURANCE; SUPPLEMENTAL LIABILITY PROTECTION AND ROADSIDE ASSISTANCE PROTECTION. BEFORE DECIDING TO PURCHASE ANY OF THESE PRODUCTS, YOU MAY WISH TO DETERMINE WHETHER YOUR PERSONAL INSURANCE, CREDIT CARD OR OTHER COVERAGE PROVIDES YOU PROTECTION DURING THE RENTAL PERIOD. THE PURCHASE OF ANY OF THESE PRODUCTS IS NOT REQUIRED TO RENT VEHICLE.

RENTER ACKNOWLEDGEMENT OF LOCAL ADDENDUM



FORM# 41FLHC-JK_UC18

RENTER ACKNOWLEDGEMENT OF THE ENTIRE AGREEMENT

I, THE "RENTER" SIGNING BELOW, HAVE READ AND AGREE TO THE TERMS AND CONDITIONS IN THE RENTAL AGREEMENT JACKET. BY SIGNING BELOW, I AM AUTHORIZING OWNER TO CHARGE TO THE CREDIT CARD(S) AND/OR DEBIT CARD(S) THAT I HAVE PROVIDED TO OWNER ALL AMOUNTS OWED BY ME UNDER THIS AGREEMENT FOR ADVANCE DEPOSITS, INCREMENTAL AUTHORIZATIONS/DEPOSITS, AND ANY OTHER AMOUNTS OWED BY ME, AS WELL AS PAYMENTS REFUSED BY A THIRD PARTY TO WHOM BILLING WAS DIRECTED. I ALSO AUTHORIZE OWNER TO RE-INITIATE ANY CHARGE TO MY CARD(S) THAT IS DISHONORED FOR ANY REASON. I CERTIFY THAT THE DRIVERS LICENSE(S) PRESENTED IS CURRENTLY VALID AND IS NOT SUSPENDED, EXPIRED, REVOKED, CANCELLED OR SURRENDERED. I FURTHER ACKNOWLEDGE AND CONSENT TO THE DISPUTE RESOLUTION PROVISIONS CONTAINED IN THIS AGREEMENT.



3L1RF9

Terms and Conditions electronically accepted by the Renter

Atencin
Ada
Brown

(5)

From: DoNotReply@Enterprise.com
Sent: Monday, September 24, 2018 9:25 AM
To: [REDACTED]
Subject: Enterprise Rental Agreement 3L1RF9



Hi, [REDACTED] thanks for choosing Enterprise!
This email is not your Rental Agreement. Attached is your full Rental Agreement and Terms and Conditions for RA # [REDACTED] from AUTONATION FORD ML.

Rental Agreement Summary

RA#: [REDACTED]
Renter: [REDACTED]

Additional Drivers

No Additional Drivers are authorized to drive the vehicle with the exception of the drivers listed below.
(Additional driver names listed here if applicable)

Dates & Times

Location

Monday, September 24, 2018 9:14 AM	AUTONATION FORD ML 16800 NW 57TH AVE MIAMI, FL 33015-4328 (305) 558-3982
Wednesday, September 26, 2018 9:00 AM	AUTONATION FORD ML 16800 NW 57TH AVE MIAMI, FL 33015-4328 (305) 558-3982

Vehicle

Make / Model: FORD / F15C
Color: SILVER
Mileage: 18229

Atencion
Ada Brown

(5)

 **Dates & Times**

Fuel: EMPTY

License #:



Vehicle #:

 **Location**

 **Terms and Conditions**

[Click to view Terms and Conditions](#)

For questions or concerns regarding your rental please contact us at [\(305\) 558-3982](tel:3055583982)

Atencio Down

AutoNation



CUSTOMER #:

[REDACTED]

AutoNation Ford Miami

16800 N.W. 57th Ave.
MIAMI, FL 33015
(305) 557-5580

Mon. Fri. 7:00 am to 7:00 pm
Sat. 7:00 am to 5:00 pm
MVR 22106360 MV 43251
www.autonation.com

INVOICE

PAGE 1

HIALEAH, FL
HOME: CONT
BUS:

SERVICE ADVISOR: 7556 OTTO VAZQUEZ

COLOR	YEAR	MAKE/MODEL	VIN	LICENSE	MILEAGE IN / OUT	TAG	
	17	FORD EXPLORER	LFM5K7D80H		4048/4048		
DEL. DATE	PROD. DATE	WARR. EXP.	PROMISED	PO NO.	RATE	PAYMENT	INV. D
27NOV16 DD			18:00 21APR18			CASH	30APR18

R.O. OPENED	READY	OPTIONS	SOLD-STK:HGB37897	DLR:207391			
07:59 21APR18	12:30 30APR18	ENG V6_CYL	TRN:A				
LINE	OPCODE	TECH	TYPE	HOURS	LIST	NET	TOTAL

A Customer requested to have Multi Point Inspection performed this visit

CAUSE: PERFORMED MULTI POINT INSPECTION

MULTI-A Customer requested to have Multi Point Inspection performed this visit

99CFMPI	0.00	0.00	0.00	0.00	0.00
GBK BRAKES INSPECTED AND ARE OK AT THIS TIME	99CFMPI	0.00	0.00	0.00	0.00
GBATT BATTERY TESTED AND IS OK ON THIS VISIT	99CFMPI	0.00	0.00	0.00	0.00
GTIRE TIRES CHECKED AND ARE OK AT THIS TIME	99CFMPI	0.00	0.00	0.00	0.00
DSWB Declined Wiper Blade /Insert Replacement	99CFMPI	0.00	0.00	0.00	0.00

PARTS: 0.00 LABOR: 0.00 OTHER: 0.00 TOTAL LINE A: 0.00

B 17N03 CARBON MONOXIDE CONCERNS
SOP SPECIAL ORDER PARTS

99 CF	0.00	0.00	0.00	0.00	0.00
-------	------	------	------	------	------

PARTS: 0.00 LABOR: 0.00 OTHER: 0.00 TOTAL LINE B: 0.00

C ***Thank you for joining us in the fight against cancer. We've partnered with the BCRF to raise funds for the world's most promising research to eradicate breast cancer. 100% of your donation goes to BCRF. Please visit DrivePink.com for more info.***

DDRV AutoNation Supports BCRF. If you decide to donate at later time please visit www.drivepink.com. Thank you for your support!

99 CF	0.00	0.00	0.00	0.00	0.00
-------	------	------	------	------	------

PARTS: 0.00 LABOR: 0.00 OTHER: 0.00 TOTAL LINE C: 0.00

D AP*-Indicates you chose to use aftermarket parts (AP) for this job.

DESCRIPTION	TOTALS
LABOR AMOUNT	
PARTS AMOUNT	
GAS, OIL, LUBE	
SUBLET AMOUNT	
MISC. CHARGES*	
TOTAL CHARGES	
LESS INSURANCE	
SALES TAX	
PLEASE PAY THIS AMOUNT	

By signing below, you acknowledge that you were notified of and authorized the Dealership to perform the services/repairs itemized in this invoice and that you received (or had the opportunity to inspect) any replaced parts as requested by you. The vehicle is being returned to you in exchange for your payment of the Amount Due.

If Payment is Made By Check When you provide a check as payment, you authorize us to either use information from your check to make a one-time electronic fund transfer from your account or to process the payment as a check transaction. If processed as an EFT, funds may be withdrawn from your account as soon as today. You agree that you will not dispute as electronically debiting your account, so long as the amount corresponds to the amount on this invoice. In the event your check or EFT is returned unpaid for any reason, you authorize us or our agent to charge a service fee up to the maximum amount permitted by law.

*SHOP SUPPLY COSTS: We have added a charge equal to \$3.00 or 12% of the total cost of labor and parts, whichever is greater, to the Repair Order. This charge will not exceed \$50.95. This charge represents costs and profits to the motor vehicle repair facility for miscellaneous shop supplies and waste disposal. The State of Florida requires a \$1.00 fee to be collected for each new tire sold in the state (\$403.718), and a \$1.50 fee to be collected for each new or remanufactured lead-acid battery sold in the state (\$403.7185).

ALL PARTS ARE NEW UNLESS OTHERWISE INDICATED.

WARRANTY STATEMENT AND DISCLAIMER: PLEASE SEE THE DEALERSHIP'S LIMITED WARRANTY ON THE REVERSE SIDE OF THIS REPAIR CUSTOMER COPY

CUSTOMER #:

[Redacted Customer Information]

Atkinson

AutoNation

(6)

AutoNation Ford Miami

16800 N.W. 57th Ave.
MIAMI, FL 33015
(305) 557-5580

Mon. Fri. 7:00 am to 7:00 pm
Sat. 7:00 am to 5:00 pm
MVR 22106360 MV 43251
www.autonation.com

INVOICE

PAGE 2

HIALEAH, FL
HOME
BUS:

SERVICE ADVISOR: 7556 OTTO VAZQUEZ

COLOR	YEAR	MAKE/MODEL	VIN	LICENSE	MILEAGE IN / OUT	TAG	
MAGNETIC M	17	FORD EXPLORER	LFM5K7D80HG		4048 / 4048		
DEL. DATE	PROD. DATE	WARR. EXP.	PROMISED	PONO.	RATE	PAYMENT	INV. DATE
27NOV16 DL			18:00	21APR18		CASH	30APR18
R.O. OPENED	READY	OPTIONS:	SOLD-STK:HGB37897 DLR:207391				
07:59	21APR18	12:30	30APR18	ENG V6_CYL TRN:A			
LINE	OPCODE	TECH	TYPE	HOURS	LIST	NET	TOTAL

AP Parts are quality parts suitable for your vehicle, but are not sourced from the vehicle manufacturer. All AP parts come with a warranty backed by AutoNation at any of our stores.

AMPARTS AP*-Indicates you chose to use aftermarket parts (AP) for this job. AP Parts are quality parts suitable for your vehicle, but are not sourced from the vehicle manufacturer. All AP parts come with a warranty backed by AutoNation at any of our stores.

99 CF 0.00 LABOR: 0.00 OTHER: 0.00 TOTAL LINE D: 0.00 0.00

Dealer is not authorized to perform recall repairs for non-Dealer brand vehicles and Dealer's Vehicle Safety and Condition Inspection and/or service does not include review of possible pending recalls or service campaigns issued by manufacturers of other makes and models.

By signing below, you acknowledge that you were notified of and authorized the Dealership to perform the services/repairs itemized in this invoice and that you received (or had the opportunity to inspect) any replaced parts as requested by you. The vehicle is being returned to you in exchange for your payment of the Amount Due.

If Payment is Made By Check When you provide a check as payment, you authorize us to either use information from your check to make a one-time electronic fund transfer from your account or to process the payment as a check transaction. If processed as an EFT, funds may be withdrawn from your account as soon as today. You agree that you will not dispute us electronically debiting your account, so long as the amount corresponds to the amount on this invoice. In the event your check or EFT is returned unpaid for any reason, you authorize us or our agent to charge a service fee up to the maximum amount permitted by law.

* SHOP SUPPLY COSTS: We have added a charge equal to \$3.00 or 12% of the total cost of labor and parts, whichever is greater, to the Repair Order. This charge will not exceed \$59.95. This charge represents costs and profits to the motor vehicle repair facility for miscellaneous shop supplies and waste disposal. The State of Florida requires a \$1.00 fee to be collected for each new tire sold in the state (\$403.718), and a \$1.50 fee to be collected for each new or remanufactured lead-acid battery sold in the state (\$403.718).

ALL PARTS ARE NEW UNLESS OTHERWISE INDICATED.

DESCRIPTION	TOTALS
LABOR AMOUNT	0.00
PARTS AMOUNT	0.00
GAS, OIL, LUBE	0.00
SUBLET AMOUNT	0.00
MISC. CHARGES *	0.00
TOTAL CHARGES	0.00
LESS INSURANCE	0.00
SALES TAX	0.00
PLEASE PAY THIS AMOUNT	0.00

DATE CUSTOMER SIGNATURE AUTHORIZED DEALERSHIP REPRESENTATIVE SIGNATURE

WARRANTY STATEMENT AND DISCLAIMER: PLEASE SEE THE DEALERSHIP'S LIMITED WARRANTY ON THE REVERSE SIDE OF THIS REPAIR CUSTOMER COPY

INVOICE

Atencio
Ada Brown

Invoice

Tag

AutoNation

AutoNation Ford Miami
16800 N.W. 57th Ave.
MIAMI, FL 33015
(305) 557-5580
www.autonation.com

Mon. Fri. 7:00 am to 7:00 pm
Sat. 7:00 am to 5:00 pm
MVR 22106360 MV 43251

HIACLEAH, FL

Home: Bus:

Cell: Email:

ice Advisor: **7556 OTTO VAZQUEZ**

COLOR	YEAR	MAKE/MODEL	VIN	LICENSE	MILEAGE IN	MILEAGE OUT		
MAGNETIC M	17	FORD EXPLORER	1FM5K7D80HG		5534	5534		
DEL DATE	PROD. DATE	WARR. EXP.	PROMISED	PO NO.	RATE	INV. DATE	R.O. OPENED	READY
27NOV16 D			18:00 09OCT18		CASH	17OCT18	09:22 09OCT18	12:01 17OCT18

OPTIONS: SOLD-STK:HGB37697 DLR:207391 ENG:3.5L_V6_CYL TRN:A

MODULE UP TO DATE ON CALIBRATION. VISUALLY INSPECTED REAR WEATHER SEAL. WEATHER SEAL OKAY AT THIS TIME. INSPECT FOR ALL 3 DRAIN PLUGS. ALL 3 DRAIN PLUGS PRESENT AT THIS TIME. REMOVED REAR LAMP ASSEMBLIES. INSPECTED ALL GROMMETS AND BODY SEALER. OKAY AT THIS TIME. REMOVED REAR QUARTER PANEL MOLDINGS. INSPECTED INNER PANELS FOR GAPS AND MISSING SEALANT. OKAY AT THIS TIME. APPLIED SEALANT TO UNDERSIDE OF VEHICLE. APPLIED MASTIC PATCHES TO GROMMETS. REMOVED REAR BUMPER. INSTALLED NEW AIR EXTRACTORS. RE INSTALLED ALL PARTS REMOVED IN PROCESS. ROAD TEST VEHICLE WITH MANAGER. OKAY AT THIS TIME.

We are a proud retailer of Original Equipment (OE) parts, sourced from the vehicle manufacturer and backed by its limited warranty.

We also offer high quality non-OE parts that are suitable for your vehicle and fit all budgets and needs. If you have chosen a non-OE part, it will be identified on your invoice as "AP." These non-OE (AP) parts are not sourced from the vehicle's manufacturer or covered by its warranty. Non-OE parts come with a limited warranty backed by AutoNation and/or the parts manufacturer.

NWD: NO WORK DONE

PARTS: 0.00 LABOR: 0.00 OTHER: 0.00 TOTAL LINE C: 0.00

D GOODWILL RENTAL CAR

NWD CUST NEVER TAKE A RENTAL
99 CF

PARTS: 0.00 LABOR: 0.00 OTHER: 0.00 TOTAL LINE D: 0.00

E ***Thank you for joining us in the fight against cancer. We've partnered with the BCRF to raise funds for the world's most promising research to eradicate breast cancer. 100% of your donation goes to BCRF. Please visit DrivePink.com for more info.***

DDRV AutoNation Supports BCRF...If you decide to donate at later time please visit www.drivepink.com. Thank you for your support!

PARTS: 0.00 LABOR: 0.00 OTHER: 0.00 TOTAL LINE E: 0.00

-4155

By signing below, you acknowledge that you were notified of and authorized the Dealership to perform the services/repairs itemized in this invoice and that you received (or had the opportunity to inspect) any replaced parts as requested by you. The vehicle is being returned to you in exchange for your payment of the Amount Due.
If Payment is Made By Check When you provide a check as payment, you authorize us to either use information from your check to make a one-time electronic fund transfer from your account or to process the payment as a check transaction. If processed as an EFT, funds may be withdrawn from your account as soon as today. You agree that you will not dispute us electronically debiting your account, so long as the amount corresponds to the amount on this invoice. In the event your check or EFT is returned unpaid for any reason, you authorize us or our agent to charge a service fee up to the maximum amount permitted by law.

*SHOP SUPPLY COSTS: We have added a charge equal to \$3.00 or 12% of the total cost of labor and parts, whichever is greater, to the Repair Order. This charge will not exceed \$59.95. This charge represents costs and profits to the motor vehicle repair facility for miscellaneous shop supplies and waste disposal. The State of Florida requires a \$1.00 fee to be collected for each new tire sold in the state [s.403.718], and a \$1.50 fee to be collected for each new or remanufactured lead-acid battery sold in the state [s.403.7185].

ALL PARTS ARE NEW UNLESS OTHERWISE INDICATED.

LABOR AMOUNT	
PARTS AMOUNT	
GAS, OIL, LUBE	
SUBLET AMOUNT	
MISC. CHARGES	
TOTAL CHARGES	
LESS INSURANCE	
SALES TAX	
PLEASE PAY THIS AMOUNT	

DATE CUSTOMER SIGNATURE AUTHORIZED DEALERSHIP REPRESENTATIVE SIGNATURE

Atencio
Ada Brown

8

FLORIDA VEHICLE REGISTRATION

CO/AGY 1 / 25

T# [REDACTED]
B# [REDACTED]

PLATE [REDACTED] DECAL [REDACTED]

Expires **Midnight Fri 05/17/2019**

YR/MK 2017/FORD BODY UT
VIN 1FM5K7D80H [REDACTED]
Plate Type RGS NET WT 4340

COLOR BLK
TITLE 125972067

Reg. Tax	90.60	Class Code	9
Init. Reg.		Tax Months	12
County Fee	3.00	Back Tax Mos	0
Mail Fee	0.75	Credit Class	
Sales Tax		Credit Months	0
Voluntary Fees			
Grand Total	94.35		

DL/FEID [REDACTED]
Date Issued 4/27/2018 Plate Issued 11/5/2014

2ND DL# Y [REDACTED]

[REDACTED]
[REDACTED]
HIALEAH, FL 3 [REDACTED]

IMPORTANT INFORMATION

- The Florida license plate must remain with the registrant upon sale of vehicle. The registration must be delivered to a Tax Collector or Tag Agent for transfer to a replacement vehicle.
- Your registration must be updated to your new address within 30 days of moving.
 - Registration renewals are the responsibility of the registrant and shall occur during the 30-day period prior to the expiration date shown on this registration. Renewal notices are provided as a courtesy and are not required for renewal purposes.
 - I understand that my driver license and registrations will be suspended immediately if the insurer denies the insurance information submitted for this registration.

RGS - SUNSHINE STATE

[REDACTED]

[REDACTED]

Repair Order Detail - Customer Copy

Alencar
Adal
Brown

RO Number [REDACTED]

RO Status: READY TO POST

Customer [REDACTED]
Phone(s): Contact [REDACTED]
Vehicle: 1FM5K7D80H0 [REDACTED]

Main: [REDACTED]
2017 EXPL

Gen. [REDACTED]
MAGNETIC -
METALLIC

Mileage: 5,188
Service advisor: 7556
Tag number: T4499

Payment type: CASH
Promised time: 07:00 PM
Promised date: 09/27/2018

Waiter: No
Estimate: 0.00

D** GOOD WILL RENT		WF GENERAL REPAIR			N/C
Tech(s):	99				
Pts:	0.00	Lbr:	0.00	Other:	0.00
				Total Line D:	0.00
E** CAR WASH		CF WASH CAR			0.00
Tech(s):	99				
Pts:	0.00	Lbr:	0.00	Other:	0.00
				Total Line E:	0.00

Customer Pay	
Labor	28.94
Parts	0.00
Lube	0.00
Sublet	0.00
Miscellaneous/Shop Charge	3.47
Deductible	0.00
Total Charges	32.41
Less Insurance/Adjustment	0.00
Sales Tax	2.27
Total	34.68



Server: AWS Prod
 Claims loaded through: 19-SEP-2019

Vehicle Information Report

GENERAL VEHICLE INFORMATION: [\(Related Claims\)](#) [\(OLS Concerns\)](#) [\(Lincoln PDI\)](#)

VIN: IFMSK7D87F [REDACTED]	Vehicle Line WERS: T/UB - US02N EXPLORER [11-19]	Engine: T/KX - 3.5L V6 CYCLONE TIVCT
Model Year: 2015	Vehicle Line AWS: U2 - EXPLORER	Global Engine: E2273 - CYCLONE GAS V6 (NON-GTDD) - LEP
Vehicle Type: T	Vehicle Line Global: U2 - EXPLORER (NA-CAP)	Engine Plant: EN22 - LIMA
Inv. Dealer: *	Drive Code: T/A - 2 WHL L/H FRONT DRIVE	Transmission: T/WJ - 6 SPD AUTO TRANS 6F
Vehicle Status Code: S00	Body Cab Style: T/WD - 4 DOOR WAGON	Global Trans: A1104 - AT - 6F50/55 - VDP
Market Derived: F - FORD	Version/Series: T/EF - FORD SERIES	Trans Plant: AT11 - A/T VAN DYKE

BUILD INFORMATION: [\(Window Sticker\)](#) [\(MVP Info\)](#)

Region Built: NA - NORTH AMERICA	Assembly Plant: AD - CHICAGO PLANT BUILD	Vehicle Load Date: 14-APR-2015
Country Built: USA - UNITED STATES	Production Date: 12-APR-2015	Vehicle Maintenance Date: 27-JUN-2015

SALE INFORMATION:

Region Sold: NA - NORTH AMERICA	Arrival Date: 30-APR-2015	Red Carpet Lease: I
Country Sold: USA - UNITED STATES	Sale Date: 22-JUN-2015	Fleet/Retail/Co. Lease: R
Vehicle Count Flag: Y	Warranty Start Date: 22-JUN-2015	Modified Vehicle: *
Selling Dealer St/Prov: TX	Original WSD: 22-JUN-2015	Warranty Status Ind: *
Selling Dealer (code): AUTOMAX FORD [152482 - *]		Vehicle Export Flag: N

YOC:



INSTALLED OPTION INFORMATION:

Air Conditioning: T/G - DUAL ZONE AUTO TEMP CONTROL AC	Color(Trim): 0005V - MEDIUM LT STONE	Navis Engine Serial #: [REDACTED]
Alternator Amp Rating: 4A	Delivery Type: P	Paint: PNYW3 - OXFORD WHITE SOLID C/C
Audio Disc: * - [N/A]	Driveshaft Code: *	Power Antenna: AV - SATELLITE ANTENNA (SDARS)
Axle Ratio: EGAAZ - 3.39 FINAL DRIVE RATIO	Front Seat: T/B - SEAT-INDIVIDUAL-L/B DRV/PASS	Radio: MM - PREMIUM AM/FM STEREO/CD
Axle Type: * - [N/A]	Fuel Type: AK - FLEX FUEL ETHANOL	Sound System: AL - SOUND SYSTEM LEVEL 2
Battery Amp Rating: MJ	Fuel Type Engine: G - Gas	Tire Manufacturer: * - [N/A]
Brake Code: * - [N/A]	GVW Class Code: 5	Tire Brand: *
Brake Code(Service): * - [N/A]	Instrumentation: AV - HIGH SERIES CLUSTER	Tire Size: D3H48 - P245/60R18 A/S BSW
Calibration Code: EUB1SND4	Mirror(Driver Side): AX - DRIVER REMOTE AERODYNAMIC MIRR	Traction Control: AH - ROLL STABILITY CNTRL (RSC) BRK
Color(Accent): * - [N/A]	Mirror(Pnrg Side): * - [N/A]	

WERS INFORMATION:

233 rows: [\(hide\)](#)

Family Code	Feature Code	Family Description	Full Description
000	SV	ALL INT TRIM COLORS-	MEDIUM LT STONE
4H8	00	UB -B-C -CLOTH B	UB -B-C -CLOTH B
A1C	AA	UNDERBODY PROTECTION	LESS UNDERBODY PROTECTION
A1K	AA	SPLASH GUARDS-REAR	LESS REAR SPLASH GUARDS
A1L	AB	REAR END FASCIA	REAR END FASCIA-LEVEL 1
A1P	BN	FRONT DOOR SILL PROTECTION	FRT DR SCUFF PLT-MIC
A1Q	BN	REAR DOOR SILL PROTECTION	RR DR SCUFF PLT-MIC
A1V	AA	BODY ARMOR	LESS BODY ARMOR
A2N	AA	INNER DOOR LOCK HANDLES	LESS INNER DOOR LOCK HANDLES
A3C	AB	FASCIA-FRONT	FRONT FASCIA-LEVEL 1
A3E	AA	SPLASH GUARD-FRONT	L/FRT SPLASH GUARDS/MUD FLAPS
A3Z	AB	MAP POCKETS - TOTAL VEHICLE	DRV & PASS SEAT MAP POCKETS
A5A	AA	STORAGE BINS	LESS STORAGE
A5I	AA	CENTRE CONSOLE TOP FINISHER	LESS CTR CONSOLE TOP FINISHER
A5M	AB	STAR RATING PERF LEVEL	STAR RATING PERF LEVEL 1
A64	AB	MY KEY	MY KEY
A6Z	AA	CARGO AREA PROTECTOR	LESS CARGO AREA PROTECTOR
A7B	AC	TAILGATE APPLIQUES	TAILGATE APPLIQUE-BRIGHT
A7F	AC	LIFTGATE/DECKLID	LIFTGATE - POWER
A7P	AB	WORLDWIDE MFG INDICATOR (WMI)	WMI 1
AA5	DJ	LIGHT TRUCK WHEELBASES	112 6/2860 MM WHEELBASE
AA9	AA	SERVICE CONTRACTS	LESS SERVICE CONTRACT
AAA	AD	VERSION-MFC	XLT VERSION
AAC	AA	VERSION PACKAGES	LESS VERSION PACKAGES
AAG	AD	PLANT BUILD REQUIREMENTS	CHICAGO PLANT BUILD
AAQ	AA	TERRAIN PACKAGES	LESS TERRAIN PACKAGE
AAZ	FF	GVWS	6120 LB GVW
AB2	AA	APPEARANCE GROUP	LESS APPEARANCE GROUP
AC	G	AIR CONDITIONER	DUAL ZONE AUTO TEMP CONTROL AC
AD2	AB	FEATURE CONTENT GROUP	FEATURE CONTENT GROUP 1
AD6	AX	PROTOTYPE PROGRAM CONTROL	2015 JOB #1 PROGRAM CONTROL
AD1	AB	TEMP ZONES	NORMAL TEMP ZONES
ADW	AS	GROUP MARKETS	GROUP MARKET #17
AEB	AA	TAILGATE BADGES	LESS TAILGATE BADGES
AEA	AE	LABELS-SPECIAL LANGUAGE	ENGLISH LANGUAGE LABEL
AED	AB	OWNER HAND BOOK PACK	OWNER HAND BOOK PACK

B2C	AF	WINDOWS-FRONT SIDE	PWR FRT W'DOWS ONE TOUCH UP/DN
B2D	AC	WINDOWS-REAR SIDE	POWER REAR SIDE WINDOW
B2G	AE	WINDOWS-TINT	PRIVACY GLASS
B2J	AA	E-MARKED GLASS	LESS E-MARKED
B2M	AC	WINDOWS-FRONT SIDE GLASS TYPE	WINDOWS-FRT SD LAMINATED GLASS
B5S	AW	UNIQUE CONSOLE TOP PLATE	CONSOLE TOP PLATE-FINISH 2
B5V	AB	CONSOLE-OVERHEAD	OVERHEAD CONSOLE
B5W	CB	CONSOLE-FLOOR	CENTRE CONSOLE-LEVEL 2
B5X	AA	REAR FLOOR CONSOLE	LESS REAR FLOOR CONSOLETTTE
BBG	AG	FLOOR COVERING-PASS AREA-CAR	CARPET FLOOR COVERING-LEVEL 1
BBH	AB	FLOOR MATS-FRONT	FRONT THROW IN CARPET FLR MATS
BBI	AB	FLOOR MATS-REAR	REAR THROW IN CARPET FLR MATS
BCA	AE	SUNVISORS-DRIVER	SUNVISOR,SINGLE-DRV ILLUM
BCB	AE	SUNVISORS-PASS E	SUNVISOR,SINGLE-PASS ILLUM
BCM	AC	DOOR TRIM PANEL-DRIVER & PASS	DOOR TRIM PANEL-LEVEL 2
BDC	AA	CARGO AREA COVER	LESS CARGO AREA COVER
BDF	AA	CARGO COMPARTMENT NET	LESS CARGO COMPARTMENT NET
BEJ	AL	INTR GRAB HANDLES	INTR GRAB HANDLES - FRONT/REAR
BLD	DS	GRILLE-FRONT	GRILLE - SILVER
BLY	AX	ROOF RACK	RF RACK-SILVER PAINTED RAILS
BML	A2	MOLDINGS-EXTERIOR LOWER	LWR BDY/SD MLDG-CHROME
BMS	AA	DOOR EDGE GUARDS	LESS DOOR EDGE GUARDS
BMW	AA	AUX ROOF RACK CROSSBARS	LESS AUX ROOF RACK CROSSBARS
BSB	AF	MIRROR-INTERIOR REAR VIEW	ELECTROCHROMIC INSIDE MIRROR
BSH	AX	MIRROR-EXTERIOR DUAL	DUAL POWER/HEATED MIRRORS
BY1	AA	SEAT-TEMP CONTROLLED DRIVER	LESS TEMP CONTROL DRIVER SEAT
BY2	AA	SEAT-TEMP CONTROLLED PASSENGER	LESS TEMP CONTROL PASSNGR SEAT
BY3	AA	SEAT-HEATED REAR	LESS REAR HEATED SEAT
BYB	AM	SECOND ROW SEATING	SECOND ROW 60/40 (3 P)-FOLDING
BYC	A2	THIRD ROW SEATING	THIRD ROW SPLIT BENCH SEAT
BYP	AC	SEAT ADJUSTER-DRIVER	POWER 6-WAY DRIVER SEAT ADJUST
BYQ	AC	SEAT ADJUSTER-PASSENGER	POWER 6-WAY PASS SEAT ADJUST
BYR	AA	SEAT CONTROL-PROGRAM DRIVER	LESS PROGRAMMABLE DRIVER SEAT
BYX	AA	SEAT CONTROL-PROGRAM REAR	LESS SEAT CONTROL PROGRAM-REAR
C1C	AA	TRAILER TOWING	LESS TRAILER TOWING PACKAGE
C2M	AA	INTERCEPTOR SIREN/SPEAKER	LESS INTERCEPTOR SIREN/SPEAKER
C2N	AA	RR CONSOLE MOUNTING PLATE	LESS RR CONSOLE MOUNTING PLATE
C3A	AA	DECAL APPEARANCES 1	LESS DECAL OPTION 1
C3B	AA	DECAL APPEARANCES 2	LESS DECAL OPTION 2
C3C	AA	DECAL APPEARANCES 3	LESS DECAL OPTION 3
C4A	AA	SPECIAL SERVICE VEHICLES 1	LESS SPECIAL SRVC VEHICLES 1
C4B	AA	SPECIAL SERVICE VEHICLES 2	LESS SPECIAL SRVC VEHICLES 2
C4C	AA	SPECIAL SERVICE VEHICLES 3	LESS SPECIAL SRVC VEHICLES 3
C4D	AA	SPECIAL SERVICE VEHICLES 4	LESS SPECIAL SRVC VEHICLES 4
C9L	AA	OIL COOLER-ENGINE	LESS ENGINE OIL COOLER
CA	WD	ALL VANS	4 DOOR WAGON
CAA	AD	DOOR HANDLE-EXTERIOR	EXTERIOR DOOR HANDLE-CHROME
CAE	AB	GEARSHIFT KNOB	LEATHER GEAR SHIFT KNOB
CAT	AA	FLEET KEY	LESS FLEET KEY
CAU	AA	KEYED ALIKE OPTIONS	LESS KEYED ALIKE OPTIONS
CB7	AB	FREQUENCY	FREQUENCY - 315 MHZ
CBA	AB	LOCKS-DOOR	POWER DOOR LOCKS
CBF	AE	DOOR ENTRY REMOTE CNTR UNIT	ILLUMINATED DOOR ENTRY KEYPAD
CBG	AD	KEYLESS ENTRY/START SYSTEM	KEYLESS ENTRY-KEY FOB
CBM	AD	FUEL FILLER DOOR LOCK	CAPLESS FUEL FILLER W/O LOCK
CFE	AH	WASHER/WIPER-WINDSHIELD	SPEED SENSITIVE W'SHLD WIPERS
CHA	AA	ROOF-OPENING PANELS	LESS ROOF OPENING PANELS
CJB	AA	TU-TONE ACCENT COLOR	LESS TU-TONE ACCENT COLOR
CLV	AD	LICENSE PLATE BRACKET-FRONT	FRT LICENSE PLATE HOLDER DELUX
CLX	AA	LICENSE PLATE BRACKET-REAR	LESS REAR LICENSE PLATE BRACKET
CMA	AA	REAR BUMPER LOAD PROTECTOR	LESS RR BUMPER LOAD PROTECTOR
CN7	AY	RESTRAINT DEVICE PACKAGES	BL/D-P FR/S/123 R/P KN BG
CPC	AA	SEAT BELTS-REAR	LESS REAR SEAT BELTS
D17	BU	WHEEL-SPARE	SPARE WHEEL-18" MINI
D2U	EH	WHEEL SIZE/STYLE-18 INCH	18X8 0" ALUM PNTD EURO FLANGE
D3H	A8	TIRES-18 INCH	P245/60R18 A/S BSW
D3M	AM	TIRE SPARE	18" MINI SPARE TIRE
D5A	AA	WHEEL COVERS	LESS WHEEL COVERS
D5H	AA	LOCKING LUG NUT KIT-WHEEL	LESS LOCKING LUG NUT KIT-WHEEL
DEB	AA	HEATER-ENGINE	LESS IMMERSION HEATER
DEF	AB	REMOTE STARTER	REMOTE STARTER
DGA	AB	EMISSION REQUIREMENTS-MFC	49 STATE/NON GREEN STATE REQ
DR	A	HVY TRUCK	2 WHL L/H FRONT DRIVE
EGA	AZ	FINAL DRIVE RATIO-SINGLE SPEED	3.39 FINAL DRIVE RATIO
EN	KX	HP/RPM/TRQ	3.5L V6 CYCLONE TIVCT
F5B	AE	EXHAUST PIPE EXTENSION	DUAL CHROME EXHAUST EXTENSION
FBB	AC	BRAKE CALIPERS AND PADS	HVY DUTY FRT/RR CALP & PADS
FEF	AH	BRAKES-ANTI SPIN TRACTION	ROLL STABILITY CNTRL (RSC) BRK
FF1	AB	ASSEMBLY PLANT FUEL FILL	NORMAL FUEL FILL
FLI	AB	TRANSMISSION LINKAGE	FLOOR MOUNTED SHIFT LINKAGE
FLN	AD	MANUAL SHIFT AUTO TRANS	SLCT SHF TECH (SST) W/PADL SHF
FMJ	AA	TRANSMISSION POWER TAKEOFF	LESS TRANSMISSION PWR TAKEOFF
FS	B	SEAT	SEAT-INDIVIDUAL-L/B DRV/PASS
G1B	AB	AUX OVERHEAD HEATER & A/C	AUX OVERHEAD HEATER & A/C
GBV	AK	ENGINE FUEL CAPABILITY	FLEX FUEL ETHANOL
GCD	AC	ADJUSTABLE FOOT PEDALS	FIXED FOOT PDLS
GPA	A1	STEERING AIDS	POWER STEERING - TAS-40
GRA	AF	STEERING COLUMNS	STRG COLUMN-TILT/TELESCOPING
GRB	AA	STEERING COLUMN LOCKS	LESS STEERING COLUMN LOCK

	AC	STEERING WHEELS	STEERING WHEEL-LUXURY
GTB	AA	HEATED STEERING WHEELS	LESS HEATED STEERING WHEELS
GTC	AA	ELECTRONIC SPEED LIMITATION	LESS ELECTR SPEED LIMITATION
GTD	AB	SPEED CONTROL	SPEED CONTROL
GTE	AH	REDUNDANT CNLTS ON STEERING WL	REDUNDANT CTL -STEER WHL-2
HCA	AV	INSTRUMENTATION-TYPE	HIGH SERIES CLUSTER
HDB	AA	HOURMETER	LESS HOURMETER
HDH	AB	SPEEDOMETERS	MPH/KPH SPEEDOMETER
HJC	AB	TIRE INFLATION MONITOR	TIRE INFLATION MONITOR
HJE	AB	THERMOMETER-OUTSIDE TEMP	OUTSIDE TEMP THERMOMETER
HJF	AB	DISPLAYS-COMPASS	COMPASS DISPLAY
HKC	AA	NAVIGATION CENTER	LESS NAVIGATION CENTER
HLE	AA	LANE DEPARTURE WARNING SYSTEM	LESS LANE DEPARTURE WARNG SYST
HLH	AB	PROXIMITY SENSOR	REVERSE PROXIMITY SENSOR*DSN A
HLL	AA	BLIND SPOT INFORMATION SYSTEM	LESS BLIND SPOT INFO SYSTEM
HMI	AD	HUMAN MACHINE INTERFACE	HUMAN MACHINE INTERFACE 3
HNA	AD	SECURITY SYSTEMS	PERIMETER ANTI-THEFT
HNS	AA	AUTOMATED PARKING SYSTEM	LESS AUTOMATED PARKING SYSTEM
HTB	AS	BATTERIES-NAAO HVY TRK	BATTERY-1- 38 AMP (340CCA)
HUA	AC	ALTERNATORS	HEAVY DUTY ALTERNATOR
HUK	AA	POWER CONVERTOR	LESS POWER CONVERTOR
IB9	AB	REGION - ELECTRONIC EQUIPMENT	REGION 1-ELECTRONIC EQUIPMENT
IBA	MM	RADIOS	PREMIUM AM/FM STEREO/CD
IBB	AB	RADIO RECEPTION EQUIPMENT	SATELLITE RADIO RECEPT-AUDIO
IBM	AT	RADIO FREQUENCY	GROUP 1 RADIO FREQUENCY
IBV	AA	REAR SEAT ENTERTAINMENT	LESS REAR SEAT ENTERTAINMENT
IBW	AG	AUDIO OPTION PACK	AUDIO OPTION PACK 3
IBY	AB	TYPE OF AUDIO BROADCAST	ANALOGUE AUDIO BROADCAST
ICD	AV	RADIO ANTENNA	SATELLITE ANTENNA (SDARS)
IDA	AL	SOUND SYSTEM	SOUND SYSTEM LEVEL 2
IDF	AA	SPEAKER WIRING-2 WAY RADIO	LESS SPKR WIRING -2 WAY RADIO
IEL	AA	RADIO NOISE SUPPRESSION	LESS RADIO NOISE SUPPRESSION
IET	AD	MICROPHONE	MICROPHONE
IEV	AG	MEDIA GATEWAY MODULE (MGM)	SYNC II
IGD	AA	GARAGE DOOR OPENER	LESS GARAGE DOOR OPENER
J1A	AA	WIRING PREP	LESS WIRING PREP
J3C	AA	SMOKERS PACKAGE	LESS SMOKERS PACKAGE
J3F	AA	POWER POINT PLUG - REAR	LESS POWER POINT PLUG - REAR
J3K	AB	CAMERA	REAR VIEW CAMERA-FIXED
JBB	AS	HEADLAMPS-DESIGN	HALOGEN HEADLAMPS W/O ADJUSTMT
JBC	AA	HEADLAMPS-RUNNING	LESS DAYTIME RUNNING LAMPS
JBK	AB	FOG LAMPS-FRONT	FRONT FOG LAMPS
JBM	AA	SPOT LIGHT	LESS SPOT LIGHT
JBS	AA	RIGHT HAND SPOT LIGHT	LESS R/H SPOT LIGHT
JBW	AA	LIGHTING PACKAGES	LESS LIGHTING PACKAGES
JCF	AA	HEADER LIGHTS-INTERIOR MAP	LESS HEADER MOUNTED MAP LIGHT
JCG	AM	HEADER LIGHTS-ROOF	FRONT AND REAR LAMP BULB
JCL	AB	GLOVE BOX LIGHTS	GLOVE BOX LIGHTS
JCR	AA	AUX INTERIOR LIGHTS	LESS AUX INTERIOR LIGHTS
JCS	AA	INTERIOR LIGHTS DEACTIVATION	LS INTER LIGHTS DEACTIVATION
JDA	AB	TAIL LAMPS	TAIL LAMPS-LEVEL 1
JDC	AA	MARKER LAMPS-SIDE	LESS SIDE MARKER LAMPS
JDJ	AA	LAMPS-REAR FOG	LESS REAR FOG LAMPS
JED	AC	HEADLAMP CONTROL	AUTOMATIC HEADLAMP CONTROL OFF
JZD	AA	WIRING HARNESS	LESS WIRING HARNESS
JZN	AA	ACCESSORY CIRCUIT-AUX	LESS AUXILIARY ACCESSORY CIR
JZQ	AA	POWER DISTRIBUTION BOX-FRT	LESS PWR DISTRIBUTION BOX-FRT
MD	F	MARKET DERIVATIVE	FORD DIVISION DERIVATIVE
PNY	W3	NEUTRAL EXT PAINT FAMILY A	OXFORD WHITE SOLID C/C
SAT	AB	GENERIC COUNTRY GROUPINGS	GENERIC COUNTRY GROUP 1
SBR	AA	SPECIAL BUILD REQUIREMENTS	LESS SPECIAL BUILD REQUIREMENT
SE	EF	CARGO HEAVY TRUCK	FORD SERIES
TAP	AR	TAP CODES	TAPAR
TR	WJ	TRANS	6 SPD AUTO TRANS 6F
VL	UB	VEHICLE LINE	U502N EXPLORER
WAN	AB	NORTH AMERICA PRINCIPLE TERR	USA
XAF	AB	EXC EXPORT(GVT/MILITARY) UNITS	EXC GVMT SERVICE ADMIN
XAN	AC	EXCEPT N AMERICA PRIN TERR	EXCEPT CANADA
XAP	AE	EXCEPT ASIAN-PACIFIC PRIN TERR	EXCEPT VANUATU
XAS	AD	EXCEPT S AMERICA PRIN TERRS	EXCEPT VENEZUELA
XAT	AB	EXCEPT US TERRITORIES	EXCEPT GUAM
XSA	AA	EXCEPT AFRICAN TERRITORIES	EXCEPT BAHRAIN
XSC	AB	EXCEPT CENTRAL AMERICA TERR S	EXCEPT BELIZE
XSE	AY	EXCEPT EUROPEAN SECONDARY TERR	EXCEPT ALBANIA
XSI	AA	EXCEPT CARIBBEAN ISLAND TERR S	EXCEPT ANTIGUA
XSP	AD	EXCEPT ASIAN-PACIFIC SECDRY TR	EXCEPT CHINA
XSS	AB	EXCEPT S AMERICA SECDRY TERR	EXCEPT ARUBA
YA2	AA	CARGO STORAGE	LESS CARGO STORAGE
YAD	AA	CARGO BOX	LESS CARGO BOX
YAM	AA	SPLASH GUARDS	LESS SPLASH GUARDS
YBC	UA	MARKETING BODY CODE	MRKTG BODY CODE-K7D
YBV	AA	VEHICLE COVER	LESS VEHICLE COVER
YCE	ZZ	MRKT COMB-LAMPS DRVR/PASS	NO POS SEL FROM THIS FAMILY
YCG	AA	MRKT COMB-REM KEYLESS ENTRY	LESS MRKT CB-REM K-LESS ENTRY
YDS	AA	FUEL PLUG	LESS FUEL PLUG
YDV	AA	CARGO ORGANIZER	LESS CARGO ORGANIZER
YES	AA	WINDOW DEFLECTORS	LESS WINDOW DEFLECTORS
YEB	AA	REMOTE START	LESS REMOTE START
YEC	AA	CARGO MAT	LESS CARGO MAT

	AA	HOOD DEFLECTOR	LESS HOOD DEFLECTOR
YEL	ZZ	ROOF RAIL CROSSBARS	NO POS SEL FROM THIS FAMILY
YER	AA	HITCH/STEP-MARKETING	LESS HITCH/STEP-MRKTG
YFF	AA	SPLASH GUARD	LESS SPLASH GUARDS-DELER ACCES
YKG	AA	MK CB-FLR MATS-FRT/RR	LESS MK CB-FLR MATS-FRT/RR
YP4	AA	CARGO PACKAGE	LESS CARGO PACKAGE
YPB	AA	SAFETY PACKAGES	LESS SAFETY PACKAGE
YPD	AA	LUXURY & CONVENIENCE PACKAGE	LESS LUXURY&CONVENIENCE PKG
YPI	ZZ	APPEARANCE PACKAGES	NO POS SEL FROM THIS FAMILY
YPK	ZZ	CONVENIENCE PACKAGE	NO POS SEL FROM THIS FAMILY
YPU	AA	COMFORT PACKAGE	LESS COMFORT PACKAGE
YPW	AA	SECURITY PACKAGE	LESS SECURITY PACKAGE
YPX	ZZ	SPORT PACKAGE	NO POS SEL FROM THIS FAMILY
YQL	AB	DRIVER CONVENIENCE	DRIVER CONVENIENCE PKG
YQX	ZZ	INFO/TECH PACKAGE	NO POS SEL FROM THIS FAMILY
YVA	AA	FRT PARKG ASSIST-BMPR MNTD	LESS FR PARKG ASSIST-BMPR MNTD
YVB	AA	RR PARKG ASSIST-BMPR MNTD	LESS RR PARKG ASSIST-BMPR MNTD
YZB	CG	TPO/ORDER CODES 0-300	TPO/ORDER CODE 201B
YZK	AA	FLEET	RETAIL/STOCK

TRACEABILITY INFORMATION:

(hide)

Trace Commodity	Trace Full Number
CLL - CATALYST LIGHTOFF LEFT	EYE275816
CLR - CATALYST LIGHTOFF RIGHT	TIG180131
DA - DRIVER AIRBAG	DB550775696AC5B8
DS - DRIVER SIDE AIRBAG	T110086D42244
EN - ENGINE	E1600 070415L113900679DS 344 AA
ET - FUEL TANK	U502EH0410153031266
IPL - INSTRUMENT PANEL LOOM	6X547RTM00233
MCC - SYNC CCPU DPS CHECKSUM	D28125AB
MHP - SYNC HARDWARE PART NUMBER	EM5T-14F130-BA
MSN - SYNC ESN	XU3YLBGD
MVC - SYNC VMCU CHECKSUM	I7631FF1
MVP - SYNC VMCU PART NUMBER	EM5T-14D205-AD
PKA - PASSENGER KNEE AIRBAG	T11T058D20487
PS - PASSENGER SIDE AIRBAG	T21N087D12176
PTL - PRETENSIONER LEFT	I5085 E771D 575250 DB53 78610 E45AE
PTR - PRETENSIONER RIGHT	I5086 E771D 577745 DB53 78610 E44AE
S1L - SEATBELT ROW 1 LEFT	I5086 E771D 006575 DB53 78612D35 AH35B8
S1R - SEATBELT ROW 1 RIGHT	I5085 E771D 009726 DB53 78612D34 AF35B8
S2L - SEATBELT ROW 2 LEFT	I5083 E771D 020720 DB53 78611B69 AB35B8
S3L - SEATBELT ROW 3 LEFT	I5086 E771D 013127 BB53 78611B51 AK35B8
S3R - SEATBELT ROW 3 RIGHT	I5084 E771D 014435 BB53 78611B50 AK35B8
SR - SATELLITE RADIO	065718119575
TR - TRANSMISSION	A4921 0403155063064284DA8P 7000 CB 84

TIRE DOT INFORMATION:

LF:	*	RF:	*
LR:	*	RR:	*
LI:	*	RI:	*
SPARE:	*	DOT Plant Manufacturer:	*.*

ESP INFORMATION:

ESP Code:
 ESP Coverage(Miles):
 ESP Coverage(Time):
 ESP Plan Year:
 ESP Signature Date:

EMISSIONS INFORMATION:

* Emission Code:
 * Emission Cert Type:
 * Emission Decal Suffix:
 * Engine Family:

DGAAB - 49 STATE/NON GREEN STATE REQ.
 F
 ZXT
 FFMXT0373DM - 2015 3.5 & 3.7L EXPLORER

Any comments? You can contact



[webmaster](#)

11119

Server: AWS Prod
 Claims loaded through: 19-SEP-2019

Claim Detail Report

Note: All costs are in US dollars

Model Year = 2015; Claim Key = XXXXXXXXXX

Vehicle Information

Model Year: 2015
 Market Derived: F - FORD
 Body/Cab Type: T/WD - 4 DOOR WAGON
 Version/Series: T/EF-FORD SERIES
 Drive Type: T/A-2 WHL L/H FRONT DRIVE
 Vehicle Line: T/UB-U502N EXPLORER [11-19]
 WERS Engine Code: T/KX-3.5L V6 CYCLONE TIVCT
 WERS Transmission Code: T/WJ-6 SPD AUTO TRANS 6F
 Warranty Start Date: 22-JUN-2015
 Production Date: 12-APR-2015
 VIN: 1FM5K7D87FGXXXXXXXXXX

Claim Information

Document Number: 52995002
 Repair Date: 23-AUG-2017
 Distance: 23000
 TIS: 27
 FCC Auth: 1
 AWS Load Date: 29-AUG-2017
 Transaction Code: E84

Dealer Information

Dealer Name: AUTOMAX FORD
 Dealer Code: 09976 - *
 Address: 3301 EAST CENTRAL TEXAS EXPRESSWAY
 City: KILLEEN
 State: TX Zip Code: 765435323
 Country: USA Region Code: NA
 Phone: (254)699-2629

Expense Information

Customer Paid Amount: .00
 Deductible Amount: .00
 Dealer Paid Amount: .00
 Labor Cost: 123.82
 Misc. Expense Amount: .00
 Part Markup Amount: 71.62
 Material Cost: 250.64
 Total Cost Gross: 374.46

Cust. Concern Code: R30 - OTHER WIND NOISE TROUBLES (TURBULENCE)

Condition Code: 42 - DOES NOT OPERATE PROPERLY

Technician Comment: TSB 16-0166 VERIFIE CONCERN. PERFORMED OASIS CHECK AND FOUND TSB 16-0166 ON THE CONCERN. PERFORMED TSB. RE TESTED. ALL GOOD

Customer Comment: CUSTOMER STATES TO CHECK FOR CARBON MONOXIDE IN VEH WHILE DRIVING-CUSTOMER BOUGHT DETECTOR AND SHOWS EXCESSIVE AMOUNTS

<u>Labor Op Code</u>	<u>Labor Op Description</u>	<u>Labor Op Cost</u>
MT160166		123.82

Causal	Reported Part Number				Engineering Part Number				Part	Part Replaced	Extended		
Flag	PREF	BASE	SUFF	Description	PREF	BASE	SUFF	Description	CPSC	Quantity	Type Code	Indicator	Amount
N	FB5Z	7829165	AA	MLDG QTR WHL OPN L	FB5Z	7829165	AA	MLDG QTR WHL OPN L	010805	1	FS	Y	73.99
N	FB5Z	7829164	AA	MLDG QTR WHL OPN R	FB5Z	7829164	AA	MLDG QTR WHL OPN R	010805	1	FS	Y	74.20
N	4M8Z	54280B62	A	GRILL-QTR VENT AIR	4M8Z	54280B62	A	GRILL-QTR VENT AIR	120103	2	FS	Y	10.56
N	TA	2	B	MOTORCRAFT BATTERY	TA	2	B	MOTORCRAFT BATTERY	070107	1	MU	Y	33.17
Y	BB5Z	61280B62	B	GRL ASY QTR VEN AIR	BB5Z	61280B62	B	GRL ASY QTR VEN AIR	120103	2	FS	Y	58.72

DTC Sections: Mil. Light On = *

Flag Test Type Malfunction Cd Malfunction Cd Description Monitor Cd Monitor Cd Description

Any comments? You can contact

[webmaster](#)

Server: AWS Prod
 Claims loaded through: 19-SEP-2019

STANDARD CLAIMS LIST

AWS Online Report

Run Date: 20-SEP-19
 Note: All Costs are in US Dollars

VIN	ERS MKT BODY VER	DRIVE PLANT TRANS ENG	PROD WARR SELLING SELL	TTS WCC	PREF BASE	SUFF VRT	FUNCTION VFG	CCC	CD
	L DER CAB SERIES TYPE CD	CD	COD DATE DATE DEALER CNT						
1FMSK7D87FG	UB F T/WD T/EF T/A AD T/WJ	T/KX APR- JUN- 2015 2015	152482 USA 2 6P07 BBSZ 78406A10 C	F08 F8	V07 L15	01			
AWS Claim Ke	oc #: 43365701 FCC Auth: 1	Trx Code: 1	Labor Hrs: 2	Labor Cost: 19 78	Material Cost:	134 62	Total Cost:	154 4	
Dir Cd-Sub Cd:	ame: AUTOMAX FORD Ph: 254-6992629	St: TX Ctry Cd: USA	Reg Cd: NA	Repr Date: 29-JUL-2015	RL Cmpl Date: 29-JUL-2015	DIST (Mile): 353			
Cust Comments:	R STATES RIGHT SIDE SHOCK FOR REAR LIFTGATE HAS BROKE N, INSPECT AND ADVISE								
Tech Comment:	SHOCK ON LIFTGATE								
1FMSK7D87FG	UB F T/WD T/EF T/A AD T/WJ	T/KX APR- JUN- 2015 2015	152482 USA 27 6C04 EBSZ 7823943 BA	F07 F7	V73 B44	81			
AWS Claim Ke	oc #: 52995004 FCC Auth: 1	Trx Code: E84	Labor Hrs: 5	Labor Cost: 51 59	Material Cost:	192 11	Total Cost:	243 7	
Dir Cd-Sub Cd:	ame: AUTOMAX FORD Ph: 254-6992629	St: TX Ctry Cd: USA	Reg Cd: NA	Repr Date: 23-AUG-2017	RL Cmpl Date: 23-AUG-2017	DIST (Mile): 23000			
Cust Comments:	R STATES DRIVERS DOOR PANEL IS PEELING UP AT TOP								
Tech Comment:	D VEHICLE AND FOUND THE DRIVERS FRONT DOOR PANEL TO BE WARPING FROM PANEL REMOVED AND REPLACED DOOR TRIM								
1FMSK7D87FG	UB F T/WD T/EF T/A AD T/WJ	T/KX APR- JUN- 2015 2015	152482 USA 27 6B07 BBSZ 61280B62 B	* F5	V11 R30	42			
AWS Claim Ke	oc #: 52995002 FCC Auth: 1	Trx Code: E84	Labor Hrs: 1 2	Labor Cost: 123 82	Material Cost:	250 64	Total Cost:	374 46	
Dir Cd-Sub Cd:	ame: AUTOMAX FORD Ph: 254-6992629	St: TX Ctry Cd: USA	Reg Cd: NA	Repr Date: 23-AUG-2017	RL Cmpl Date: 29-AUG-2017	DIST (Mile): 23000			
Cust Comments:	CUSTOMER STATES TO CHECK FOR CARBON MONOXIDE IN VEH WHILE DRIVING-CUSTOMER BOUGHT DETECTOR AND SHOWS EXCESSIVE AMOUNTS								
Tech Comments:	TSB 16-0166 VERIFIE CONCERN PERFORMED OASIS CHECK AND FOUND TSB 16-0166 ON THE CONCERN PERFORMED TSB RE TESTED ALL GOOD								

Any comments? You can contact

[webmaster](#)

CITY OF MERIDAN

IMPORTANT - DO NOT PERFORM REPAIRS UNTIL AUTHORIZED!

Dealer/Fleet Request For OGC Review

*****Note: this form is for Retail and Fleet vehicles*****

Pursuant to the W&P Manual, the service manager is required to complete a Dealer/Fleet Request for OGC Review form if he/she suspects legal action such as, alleged accidents or fires, may be taken. This form includes customer and vehicle information as well as a description of the allegations.

Note: All fields are required and must be filled in accordingly before submitting this form

NOTE: You also have the option of printing this form and then faxing the fully completed form to 313-845-5668 or 313-845-5555

DEALER INFORMATION

Dealership/Fleet Name:	Bob Thomas Ford, Inc.
Requesting Dealer/Fleet:	Bob Thomas Ford, Inc.
P&A Code:	03691
Contact Person:	NancyLee Dishereits
Title:	Fleet Manager
Phone Number:	203-281-7500
Fax Number:	203-288-0233
Email Address:	bdc@bobthomasford.com
Region:	New York
Address:	2215 Dixwell Avenue
City:	Hamden
State:	Connecticut <input type="checkbox"/>
Zip Code:	06514

OGC Lit
Product Claims

NOV 13 2018

CUSTOMER/VEHICLE INFORMATION

Warranty Start Date:	09/27/2017
Vehicle Year:	2017
Vehicle Model:	K8A
Vehicle VIN:	1FM5K8AR2HC [REDACTED]
Mileage:	20849
Customer/Fleet Name:	City of Meriden
Street Address:	50 West Main Street
City:	Meriden
State:	Connecticut <input type="checkbox"/>

Zip Code: 06451
 Home Phone: 203-630-6216
 Work Phone: 203-630-6216
 Region: New York

DETAILS OF INCIDENT

*****Note: DO NOT PUT THE VEHICLE IN STORAGE OR PROVIDE LOANERS WITHOUT THE APPROVAL OF THE OFFICE OF THE GENERAL COUNSEL*****
*****NOTE: SEND AUTHORIZATION REQUEST TO FORDCALP@FORD.COM*****

Incident Involves:

Accident Fire Injury Medical Attention Sought

Date of Incident: 10/24/2018

County in which incident occurred: New Haven

Is customer alleging a component defect CAUSED the incident?
 Yes No

If yes, what type & details:
 If no, refer to Escalated Concern Handling section of the Customer Handling Roadmap

Officer hospitalized-carbon monoxide poisoning

Was a police report filed?
 Yes No

Do Not Know

If yes, where:

Has the Insurance company been contacted?
 Yes No

Do Not Know

What did the insurance company advise?

Name and phone number of owner's insurance company & agent's name:

If the vehicle is a conversion unit, who is the coach builder?

Fleet Auto Supply

City:

West Haven

State:

Connecticut

Zip Code:

06516

Vehicle Location:

<p>Attorney Information (if applicable):</p> <p>CVO Contact (if applicable - Fleet Only):</p>	<p>Bob Thomas Ford</p>
<p>RESOLUTION THAT CUSTOMER IS SEEKING:</p> <p>Inspection and verification that there is no CO intrusion into the cabin of vehicle on this and the other Interceptors in service by the Meriden police department.</p>	
<p>COMMENTS:</p> <p>See attached email from Captain of Meriden Police Department</p>	
<p style="text-align: center;"><input type="button" value="Submit Request"/></p>	

BDC

From: "Nicholas Sherwood" <nsherwood@meridenct.gov>
Date: Thursday, October 25, 2018 8:07 AM
To: "BDC" <bdc@bobthomasford.com>
Cc: "William Chizmadia" <fastpt@aol.com>; "Local 1016" <local1016@meridenct.gov>; "Jeff Cossette" <jcossette@meridenct.gov>; "Tim Topulos" <topulos@meridenct.gov>; "Mark Walerysiak" <mwalerysiak@meridenct.gov>; "Allen Jandreau" <ajandreau@meridenct.gov>; "Wilma Petro" <wpetro@meridenct.gov>; "Debbie Moore" <dmoore@meridenct.gov>; "Stephanie Dellolio" <sdellolio@meridenct.gov>
Subject: Meriden Police Fleet - Ford Explore Interceptors - Carbon Monoxide Poisoning

Ms. [REDACTED]

Hello, this email is a follow up to our brief conversation about the Meriden PD Carbon Monoxide Incident. I realize that you serve as the Meriden Police Department's sales point of contact, but I am hoping you can send this email to the appropriate personnel within the Ford Company.

THE INCIDENT

Yesterday, 10.24.2018 one of my patrol officers was operating 2017 Ford Explorer Police Interceptor (CT REG MUNICIPAL PLATE: 133ME) VIN: 1FM5K8AR2HG [REDACTED] While driving the vehicle he became light headed, nauseous and dizzy. There was a reported smell of "rotten eggs" within the vehicle. He brought the vehicle back to the Police Headquarters Building. Due to the seriousness of his symptoms, an ambulance was called for the officer and he was transported to the local hospital where he was later diagnosed with Carbon Monoxide poisoning. He was released late last night from the hospital after treatment. This incident is obviously very concerning, as there has been a documented history of concerns with the Ford Police Interceptors and Carbon Monoxide leaking into the cab of the vehicle.

RESPONSE FROM MERIDEN PD

The previously mentioned vehicle has since been pulled off-line for further testing and inspection by our on-staff mechanic. Additionally, I have ordered the mechanic to pull three other vehicles of the same make and model for testing and inspection. My mechanic has also been ordered to purchase CO2 testing kits and have them installed into the vehicles for monitoring and safety.

CONCERNS

Obviously this incident has sparked serious concerns among my officers and staff. As you are aware, the job of a police officer is stressful and dangerous. One of the last things my officers should need to worry about is becoming sick or worse from CO2 while driving their police vehicles.

REQUEST

Due to this incident, I am respectfully requesting Ford reinspect all of my Department's Ford Explorer Police Interceptors for possible CO2 leaks and contamination. My contact information is listed below. I look forward to hearing back from Ford on this matter.

Respectfully,

Captain Nicholas D. Sherwood, Badge #421

*Meriden Police Department
Administrative & Support Services Division
50 West Main Street, Meriden, CT 06451
203-630-6216 ~ Office
203-537-0047 ~ Cell
nsherwood@meridenct.gov*

"Integrity ~ Service ~ Excellence ~ Compassion ~ Fairness"

CONFIDENTIALITY: This email, including any attachments, may contain confidential, proprietary and privileged information; unauthorized disclosure or use of this information is prohibited. If you received this email in error, please notify the sender and delete this email from your system. Thank you.

Note: The information contained in this email message is confidential and may contain privileged information and material. Any review or use of the information contained in this email message by persons other than the intended recipient(s) is prohibited. Please notify the sender of this message or the City of Meriden at 203-630-4000.



**Service of Process
Transmittal**

11/14/2018

CT Log Number 

TO: Chris Dzbanski
Ford Motor Company
1 American Rd Whq 421-E6
Dearborn, MI 48126-2701

RE: Process Served in California

FOR: Ford Motor Company (Domestic State: DE)

ENCLOSED ARE COPIES OF LEGAL PROCESS RECEIVED BY THE STATUTORY AGENT OF THE ABOVE COMPANY AS FOLLOWS:

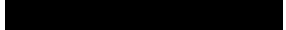
TITLE OF ACTION:  etc., Pltf. vs. Ford Motor Company, etc., et al., Dfts.

DOCUMENT(S) SERVED: Summons, Cover Sheet, Instructions, Notice(s), Complaint

COURT/AGENCY: San Diego County - Superior Court - Central Division, CA
Case # 

NATURE OF ACTION: Product Liability Litigation - Lemon Law - 2016 Ford Explorer - 1FM5K8GT0GG 

ON WHOM PROCESS WAS SERVED: C T Corporation System, Los Angeles, CA

DATE AND HOUR OF SERVICE: By Process Server on 11/14/2018 at 15:29

JURISDICTION SERVED : California

APPEARANCE OR ANSWER DUE: Within 30 days after service

ATTORNEY(S) / SENDER(S): Douglas D. Law
The Law Offices of Douglas D. Law, Esq
3223 Black Mountain Road
Suite 430
San Diego, CA 92129
858-704-8110

ACTION ITEMS: CT has retained the current log, Retain Date: 11/15/2018, Expected Purge Date: 11/20/2018

Image SOP

Email Notification, Chris Dzbanski cdzbansk@ford.com

Email Notification, Mary Ann MacKinnon mmackin1@ford.com

SIGNED: C T Corporation System
ADDRESS: 818 West Seventh Street
Los Angeles, CA 90017
TELEPHONE: 213-337-4615

2:30

11/14

SUM-100

**SUMMONS
(CITACION JUDICIAL)**

FOR COURT USE ONLY
(SOLO PARA USO DE LA CORTE)

**NOTICE TO DEFENDANT:
(AVISO AL DEMANDADO):**

FORD MOTOR COMPANY, a corporation; PENSKE FORD, an entity,
form unknown; and DOES 1 through 10, inclusive,

**YOU ARE BEING SUED BY PLAINTIFF:
(LO ESTÁ DEMANDANDO EL DEMANDANTE):**

an individual

ELECTRONICALLY FILED
Superior Court of California,
County of San Diego
11/09/2018 at 08:23:31 AM
Clerk of the Superior Court
By Maria Acevedo, Deputy Clerk

NOTICE! You have been sued. The court may decide against you without your being heard unless you respond within 30 days. Read the information below.

You have 30 CALENDAR DAYS after this summons and legal papers are served on you to file a written response at this court and have a copy served on the plaintiff. A letter or phone call will not protect you. Your written response must be in proper legal form if you want the court to hear your case. There may be a court form that you can use for your response. You can find these court forms and more information at the California Courts Online Self-Help Center (www.courtinfo.ca.gov/selfhelp), your county law library, or the courthouse nearest you. If you cannot pay the filing fee, ask the court clerk for a fee waiver form. If you do not file your response on time, you may lose the case by default, and your wages, money, and property may be taken without further warning from the court.

There are other legal requirements. You may want to call an attorney right away. If you do not know an attorney, you may want to call an attorney referral service. If you cannot afford an attorney, you may be eligible for free legal services from a nonprofit legal services program. You can locate these nonprofit groups at the California Legal Services Web site (www.lawhelpcalifornia.org), the California Courts Online Self-Help Center (www.courtinfo.ca.gov/selfhelp), or by contacting your local court or county bar association. NOTE: The court has a statutory lien for waived fees and costs on any settlement or arbitration award of \$10,000 or more in a civil case. The court's lien must be paid before the court will dismiss the case. **(AVISO! Lo han demandado. Si no responde dentro de 30 días, la corte puede decidir en su contra sin escuchar su versión. Lea la información a continuación.)**

Tiene 30 DÍAS DE CALENDARIO después de que le entreguen esta citación y papeles legales para presentar una respuesta por escrito en esta corte y hacer que se entregue una copia al demandante. Una carta o una llamada telefónica no lo protegen. Su respuesta por escrito tiene que estar en formato legal correcto si desea que procesen su caso en la corte. Es posible que haya un formulario que usted puede usar para su respuesta. Puede encontrar estos formularios de la corte y más información en el Centro de Ayuda de las Cortes de California (www.sucorte.ca.gov), en la biblioteca de leyes de su condado o en la corte que lo quede más cerca. Si no puede pagar la cuota de presentación, pida al secretario de la corte que le dé un formulario de exención de pago de cuotas. Si no presente su respuesta a tiempo, puede perder el caso por incumplimiento y la corte le podrá quitar su sueldo, dinero y bienes sin más advertencia.

Hay otros requisitos legales. Es recomendable que llame a un abogado inmediatamente. Si no conoce a un abogado, puede llamar a un servicio de remisión a abogados. Si no puede pagar a un abogado, es posible que cumpla con los requisitos para obtener servicios legales gratuitos de un programa de servicios legales sin fines de lucro. Puede encontrar estos grupos sin fines de lucro en el sitio web de California Legal Services, (www.lawhelpcalifornia.org), en el Centro de Ayuda de las Cortes de California, (www.sucorte.ca.gov) o poniéndose en contacto con la corte o el colegio de abogados locales. **AVISO: Por ley, la corte tiene derecho a reclamar las cuotas y los costos exentos por imponer un gravamen sobre cualquier recuperación de \$10,000 ó más de valor recibida mediante un acuerdo o una concesión de arbitraje en un caso de derecho civil. Tiene que pagar el gravamen de la corte antes de que la corte pueda desechar el caso.**

The name and address of the court is:
(El nombre y dirección de la corte es): San Diego Superior Court
Hall of Justice
330 W. Broadway, California 92101

CASE NUMBER:
(Número del caso)

The name, address, and telephone number of plaintiff's attorney, or plaintiff without an attorney, is:
(El nombre, la dirección y el número de teléfono del abogado del demandante, o del demandante que no tiene abogado, es):
The Law Offices of Douglas D. Law, 13223 Black Mountain, Suite 430, San Diego, CA 92129 858 704-8110

DATE: 11/13/2018
(Fecha)

Clerk, by
(Secretario)

M. Acevedo

Deputy
(Adjunto)

(For proof of service of this summons, use Proof of Service of Summons (form POS-010).)
(Para prueba de entrega de esta citación use el formulario Proof of Service of Summons. (POS-010)).



NOTICE TO THE PERSON SERVED: You are served

- as an individual defendant.
- as the person sued under the fictitious name of (specify):
- on behalf of (specify): Ford Motor Company, a corporation
under: CCP 416.10 (corporation) CCP 416.60 (minor)
 CCP 416.20 (defunct corporation) CCP 416.70 (conservatee)
 CCP 416.40 (association or partnership) CCP 416.90 (authorized person)
 other (specify):
- by personal delivery on (date):

ATTORNEY OR PARTY WITHOUT ATTORNEY (Name, State Bar number, and address):
Douglas D. Law, SBN 110829
The Law Offices of Douglas D. Law, Esq.
13223 Black Mountain Rd, Ste 430
San Diego, CA 92129
TELEPHONE NO.: 858 704-8110 FAX NO.: 858 704-7954
ATTORNEY FOR (Name): Plaintiff

FOR COURT USE ONLY
ELECTRONICALLY FILED
Superior Court of California,
County of San Diego
11/09/2018 at 08:29:31 AM
Clerk of the Superior Court
By Maria Acevedo, Deputy Clerk

SUPERIOR COURT OF CALIFORNIA, COUNTY OF San Diego
STREET ADDRESS: 330 W. Broadway
MAILING ADDRESS:
CITY AND ZIP CODE: San Diego, CA 92101
BRANCH NAME: Central Division

CASE NAME: **Ford Motor Company**

CIVIL CASE COVER SHEET
 Unlimited (Amount demanded exceeds \$25,000) Limited (Amount demanded is \$25,000 or less)

Complex Case Designation
 Counter Joinder
Filed with first appearance by defendant (Cal. Rules of Court, rule 3.402)

CASE NUMBER: [REDACTED]
JUDGE: Judge Gregory W Pollack
DEPT:

Items 1-8 below must be completed (see instructions on page 2).

1. Check one box below for the case type that best describes this case:
- | | | |
|--|--|---|
| <p>Auto Tort</p> <p><input type="checkbox"/> Auto (22)</p> <p><input type="checkbox"/> Uninsured motorist (48)</p> <p>Other P/DP/WD (Personal Injury/Property Damage/Wrongful Death) Tort</p> <p><input type="checkbox"/> Asbestos (04)</p> <p><input type="checkbox"/> Product liability (24)</p> <p><input type="checkbox"/> Medical malpractice (45)</p> <p><input type="checkbox"/> Other P/DP/WD (23)</p> <p>Non-P/DP/WD (Other) Tort</p> <p><input type="checkbox"/> Business tort/unfair business practices (07)</p> <p><input type="checkbox"/> Civil rights (68)</p> <p><input type="checkbox"/> Defamation (13)</p> <p><input type="checkbox"/> Fraud (16)</p> <p><input type="checkbox"/> Intellectual property (19)</p> <p><input type="checkbox"/> Professional negligence (26)</p> <p><input type="checkbox"/> Other non-P/DP/WD tort (35)</p> <p>Employment</p> <p><input type="checkbox"/> Wrongful termination (38)</p> <p><input type="checkbox"/> Other employment (15)</p> | <p>Contract</p> <p><input checked="" type="checkbox"/> Breach of contract/warranty (06)</p> <p><input type="checkbox"/> Rule 3.740 collections (08)</p> <p><input type="checkbox"/> Other collections (09)</p> <p><input type="checkbox"/> Insurance coverage (18)</p> <p><input type="checkbox"/> Other contract (37)</p> <p>Real Property</p> <p><input type="checkbox"/> Eminent domain/inverse condemnation (14)</p> <p><input type="checkbox"/> Wrongful eviction (33)</p> <p><input type="checkbox"/> Other real property (28)</p> <p>Unlawful Detainer</p> <p><input type="checkbox"/> Commercial (31)</p> <p><input type="checkbox"/> Residential (32)</p> <p><input type="checkbox"/> Drugs (38)</p> <p>Judicial Review</p> <p><input type="checkbox"/> Asset forfeiture (05)</p> <p><input type="checkbox"/> Petition re: arbitration award (11)</p> <p><input type="checkbox"/> Writ of mandate (02)</p> <p><input type="checkbox"/> Other judicial review (39)</p> | <p>Provisionally Complex Civil Litigation
(Cal. Rules of Court, rules 3.400-3.403)</p> <p><input type="checkbox"/> Antitrust/Trade regulation (03)</p> <p><input type="checkbox"/> Construction defect (10)</p> <p><input type="checkbox"/> Mass tort (40)</p> <p><input type="checkbox"/> Securities litigation (28)</p> <p><input type="checkbox"/> Environmental/Toxic tort (30)</p> <p><input type="checkbox"/> Insurance coverage claims arising from the above listed provisionally complex case types (41)</p> <p>Enforcement of Judgment</p> <p><input type="checkbox"/> Enforcement of judgment (20)</p> <p>Miscellaneous Civil Complaint</p> <p><input type="checkbox"/> RICO (27)</p> <p><input type="checkbox"/> Other complaint (not specified above) (42)</p> <p>Miscellaneous Civil Petition</p> <p><input type="checkbox"/> Partnership and corporate governance (21)</p> <p><input type="checkbox"/> Other petition (not specified above) (43)</p> |
|--|--|---|

2. This case is is not complex under rule 3.400 of the California Rules of Court. If the case is complex, mark the factors requiring exceptional judicial management:
- | | |
|--|--|
| a. <input type="checkbox"/> Large number of separately represented parties | d. <input type="checkbox"/> Large number of witnesses |
| b. <input type="checkbox"/> Extensive motion practice raising difficult or novel issues that will be time-consuming to resolve | e. <input type="checkbox"/> Coordination with related actions pending in one or more courts in other counties, states, or countries, or in a federal court |
| c. <input type="checkbox"/> Substantial amount of documentary evidence | f. <input type="checkbox"/> Substantial postjudgment judicial supervision |
3. Remedies sought (check all that apply): a. monetary b. nonmonetary; declaratory or injunctive relief c. punitive
4. Number of causes of action (specify): 3
5. This case is is not a class action suit.
6. If there are any known related cases, file and serve a notice of related case. (You may use form CM-015)

Date: November 9, 2018
Douglas D. Law

[Signature of Douglas D. Law]

(TYPE OR PRINT NAME)

(SIGNATURE OF PARTY OR ATTORNEY FOR PARTY)

NOTICE

- Plaintiff must file this cover sheet with the first paper filed in the action or proceeding (except small claims cases or cases filed under the Probate Code, Family Code, or Welfare and Institutions Code). (Cal. Rules of Court, rule 3.220.) Failure to file may result in sanctions.
- File this cover sheet in addition to any cover sheet required by local court rule.
- If this case is complex under rule 3.400 et seq. of the California Rules of Court, you must serve a copy of this cover sheet on all other parties to the action or proceeding.
- Unless this is a collections case under rule 3.740 or a complex case, this cover sheet will be used for statistical purposes only.

INSTRUCTIONS ON HOW TO COMPLETE THE COVER SHEET

To Plaintiffs and Others Filing First Papers. If you are filing a first paper (for example, a complaint) in a civil case, you must complete and file, along with your first paper, the *Civil Case Cover Sheet* contained on page 1. This information will be used to compile statistics about the types and numbers of cases filed. You must complete items 1 through 6 on the sheet. In item 1, you must check one box for the case type that best describes the case. If the case fits both a general and a more specific type of case listed in item 1, check the more specific one. If the case has multiple causes of action, check the box that best indicates the primary cause of action. To assist you in completing the sheet, examples of the cases that belong under each case type in item 1 are provided below. A cover sheet must be filed only with your initial paper. Failure to file a cover sheet with the first paper filed in a civil case may subject a party, its counsel, or both to sanctions under rules 2.30 and 3.220 of the California Rules of Court.

To Parties in Rule 3.740 Collections Cases. A "collections case" under rule 3.740 is defined as an action for recovery of money owed in a sum stated to be certain that is not more than \$25,000, exclusive of interest and attorney's fees, arising from a transaction in which property, services, or money was acquired on credit. A collections case does not include an action seeking the following: (1) tort damages, (2) punitive damages, (3) recovery of real property, (4) recovery of personal property, or (5) a prejudgment writ of attachment. The identification of a case as a rule 3.740 collections case on this form means that it will be exempt from the general time-for-service requirements and case management rules, unless a defendant files a responsive pleading. A rule 3.740 collections case will be subject to the requirements for service and obtaining a judgment in rule 3.740.

To Parties in Complex Cases. In complex cases only, parties must also use the *Civil Case Cover Sheet* to designate whether the case is complex. If a plaintiff believes the case is complex under rule 3.400 of the California Rules of Court, this must be indicated by completing the appropriate boxes in items 1 and 2. If a plaintiff designates a case as complex, the cover sheet must be served with the complaint on all parties to the action. A defendant may file and serve no later than the time of its first appearance a joinder in the plaintiff's designation, a counter-designation that the case is not complex, or, if the plaintiff has made no designation, a designation that the case is complex.

CASE TYPES AND EXAMPLES

Auto Tort	Contract	Provisionally Complex Civil Litigation (Cal. Rules of Court Rules 3.400-3.403)
Auto (22)—Personal Injury/Property Damage/Wrongful Death	Breach of Contract/Warranty (06)	Antitrust/Trade Regulation (03)
Uninsured Motorist (46) (if the case involves an uninsured motorist claim subject to arbitration, check this item instead of Auto)	Breach of Rental/Lease Contract (not unlawful detainer or wrongful eviction)	Construction Defect (10)
	Contract/Warranty Breach—Seller Plaintiff (not fraud or negligence)	Claims Involving Mass Tort (40)
	Negligent Breach of Contract/Warranty	Securities Litigation (28)
Other PUPDWD (Personal Injury/Property Damage/Wrongful Death) Tort	Other Breach of Contract/Warranty	Environmental/Toxic Tort (30)
Asbestos (04)	Collections (e.g., money owed, open book accounts) (08)	Insurance Coverage Claims (arising from provisionally complex case type listed above) (41)
Asbestos Property Damage	Collection Case—Seller Plaintiff	Enforcement of Judgment
Asbestos Personal Injury/Wrongful Death	Other Promissory Note/Collections Case	Enforcement of Judgment (20)
Product Liability (not asbestos or toxic/environmental) (24)	Insurance Coverage (not provisionally complex) (18)	Abstract of Judgment (Out of County)
Medical Malpractice (45)	Auto Subrogation	Confession of Judgment (non-domestic relations)
Medical Malpractice—Physicians & Surgeons	Other Coverage	Sister State Judgment
Other Professional Health Care Malpractice	Other Contract (37)	Administrative Agency Award (not unpaid taxes)
Other PUPDWD (23)	Contractual Fraud	Petition/Certification of Entry of Judgment on Unpaid Taxes
Premises Liability (e.g., slip and fall)	Other Contract Dispute	Other Enforcement of Judgment Case
Intentional Bodily Injury/PDWD (e.g., assault, vandalism)	Real Property	Miscellaneous Civil Complaint
Intentional Infliction of Emotional Distress	Eminent Domain/Inverse Condemnation (14)	RICO (27)
Negligent Infliction of Emotional Distress	Wrongful Eviction (33)	Other Complaint (not specified above) (42)
Other PUPDWD	Other Real Property (e.g., quiet title) (26)	Dedatory Relief Only
Non-PUPDWD (Other) Tort	Writ of Possession of Real Property	Injunctive Relief Only (non-harassment)
Business Tort/Unfair Business Practice (07)	Mortgage Foreclosure	Mechanics Lien
Civil Rights (e.g., discrimination, false arrest) (not civil harassment) (09)	Quiet Title	Other Commercial Complaint Case (non-tort/non-complex)
Defamation (e.g., slander, libel) (13)	Other Real Property (not eminent domain, landlord/tenant, or foreclosure)	Other Civil Complaint (non-tort/non-complex)
Fraud (16)	Unlawful Detainer	Miscellaneous Civil Petition
Intellectual Property (15)	Commercial (31)	Partnership and Corporate Governance (21)
Professional Negligence (25)	Residential (32)	Other Petition (not specified above) (43)
Legal Malpractice	Drugs (38) (if the case involves illegal drugs, check this item; otherwise, report as Commercial or Residential)	Civil Harassment
Other Professional Malpractice (not medical or legal)	Judicial Review	Workplace Violence
Other Non-PUPDWD Tort (35)	Asset Forfeiture (05)	Elder/Dependent Adult Abuse
Employment	Petition Re: Arbitration Award (11)	Election Contest
Wrongful Termination (36)	Writ of Mandate (02)	Petition for Name Change
Other Employment (18)	Writ—Administrative Mandamus	Petition for Relief From Legal Claim
	Writ—Mandamus on Limited Court Case Matter	Other Civil Petition
	Writ—Other Limited Court Case Review	
	Other Judicial Review (39)	
	Review of Health Officer Order	
	Notice of Appeal—Labor Commissioner Appeals	

SUPERIOR COURT OF CALIFORNIA, COUNTY OF SAN DIEGO

STREET ADDRESS: 330 W Broadway
 MAILING ADDRESS: 330 W Broadway
 CITY AND ZIP CODE: San Diego, CA 92101-3827
 BRANCH NAME: Central
 TELEPHONE NUMBER: (619) 450-7071

PLAINTIFF(S) / PETITIONER(S): Tessa Leann Dierkop

DEFENDANT(S) / RESPONDENT(S): Ford Motor Company et.al.

DIERKOP VS. FORD MOTOR COMPANY

**NOTICE OF CASE ASSIGNMENT
and CASE MANAGEMENT CONFERENCE**

CASE NUMBER: [REDACTED]

CASE ASSIGNMENT

Judge: Gregory W Pollack

Department: C-71

COMPLAINT/PETITION FILED: 11/09/2018

TYPE OF HEARING SCHEDULED	DATE	TIME	DEPT	JUDGE
Civil Case Management Conference	04/19/2019	01:30 pm	C-71	Gregory W Pollack

A case management statement must be completed by counsel for all parties or self-represented litigants and timely filed with the court at least 15 days prior to the initial case management conference. (San Diego Local Rules, Division II, CRC Rule 3.725).

All counsel of record or parties in pro per shall appear at the Case Management Conference, be familiar with the case, and be fully prepared to participate effectively in the hearing, including discussions of ADR* options.

IT IS THE DUTY OF EACH PLAINTIFF (AND CROSS-COMPLAINANT) TO SERVE A COPY OF THIS NOTICE WITH THE COMPLAINT (AND CROSS-COMPLAINT), THE ALTERNATIVE DISPUTE RESOLUTION (ADR) INFORMATION FORM (SDSC FORM #CIV-730), A STIPULATION TO USE ALTERNATIVE DISPUTE RESOLUTION (ADR) (SDSC FORM #CIV-359), AND OTHER DOCUMENTS AS SET OUT IN SDSC LOCAL RULE 2.1.5.

ALL COUNSEL WILL BE EXPECTED TO BE FAMILIAR WITH SUPERIOR COURT RULES WHICH HAVE BEEN PUBLISHED AS DIVISION II, AND WILL BE STRICTLY ENFORCED.

TIME STANDARDS: The following timeframes apply to general civil cases and must be adhered to unless you have requested and been granted an extension of time. General civil cases consist of all civil cases except: small claims proceedings, civil petitions, unlawful detainer proceedings, probate, guardianship, conservatorship, juvenile, parking citation appeals, and family law proceedings.

COMPLAINTS: Complaints and all other documents listed in SDSC Local Rule 2.1.5 must be served on all named defendants.

DEFENDANT'S APPEARANCE: Defendant must generally appear within 30 days of service of the complaint. (Plaintiff may stipulate to no more than 15 day extension which must be in writing and filed with the Court.) (SDSC Local Rule 2.1.6)

JURY FEES: In order to preserve the right to a jury trial, one party for each side demanding a jury trial shall pay an advance jury fee in the amount of one hundred fifty dollars (\$150) on or before the date scheduled for the initial case management conference in the action.

COURT REPORTERS: Court reporters are not provided by the Court in Civil cases. See policy regarding normal availability and unavailability of official court reporters at www.sdcourt.ca.gov.

*ALTERNATIVE DISPUTE RESOLUTION (ADR): THE COURT ENCOURAGES YOU TO CONSIDER UTILIZING VARIOUS ALTERNATIVES TO TRIAL, INCLUDING MEDIATION AND ARBITRATION, PRIOR TO THE CASE MANAGEMENT CONFERENCE. PARTIES MAY FILE THE ATTACHED STIPULATION TO USE ALTERNATIVE DISPUTE RESOLUTION (SDSC FORM #CIV-359).



Superior Court of California
County of San Diego

**NOTICE OF ELIGIBILITY TO eFILE
AND ASSIGNMENT TO IMAGING DEPARTMENT**

This case is eligible for eFiling. Should you prefer to electronically file documents, refer to General Order in re procedures regarding electronically imaged court records, electronic filing, and access to electronic court records in civil and probate cases for rules and procedures or contact the Court's eFiling vendor at www.onelegal.com for information.

This case has been assigned to an Imaging Department and original documents attached to pleadings filed with the court will be imaged and destroyed. Original documents should not be filed with pleadings. If necessary, they should be lodged with the court under California Rules of Court, rule 3.1302(b).

On August 1, 2011 the San Diego Superior Court began the Electronic Filing and Imaging Pilot Program ("Program"). As of August 1, 2011 in all new cases assigned to an Imaging Department all filings will be imaged electronically and the electronic version of the document will be the official court file. The official court file will be electronic and accessible at one of the kiosks located in the Civil Business Office and on the Internet through the court's website.

You should be aware that the electronic copy of the filed document(s) will be the official court record pursuant to Government Code section 68150. The paper filing will be imaged and held for 30 days. After that time it will be destroyed and recycled. **Thus, you should not attach any original documents to pleadings filed with the San Diego Superior Court. Original documents filed with the court will be imaged and destroyed except those documents specified in California Rules of Court, rule 3.1806.** Any original documents necessary for a motion hearing or trial shall be lodged in advance of the hearing pursuant to California Rules of Court, rule 3.1302(b).

It is the duty of each plaintiff, cross-complainant or petitioner to serve a copy of this notice with the complaint, cross-complaint or petition on all parties in the action.

On all pleadings filed after the initial case originating filing, all parties must, to the extent it is feasible to do so, place the words **"IMAGED FILE"** in all caps immediately under the title of the pleading on all subsequent pleadings filed in the action.



SUPERIOR COURT OF CALIFORNIA, COUNTY OF SAN DIEGO

ALTERNATIVE DISPUTE RESOLUTION (ADR) INFORMATION

CASE NUMBER: 37-2018-00056965-CU-BC-CTL

CASE TITLE: Dierkop vs. Ford Motor Company

NOTICE: All plaintiffs/cross-complainants in a general civil case are required to serve a copy of the following three forms on each defendant/cross-defendant, together with the complaint/cross-complaint:

- (1) this Alternative Dispute Resolution (ADR) Information form (SDSC form #CIV-730),
- (2) the Stipulation to Use Alternative Dispute Resolution (ADR) form (SDSC form #CIV-359), and
- (3) the Notice of Case Assignment form (SDSC form #CIV-721).

Most civil disputes are resolved without filing a lawsuit, and most civil lawsuits are resolved without a trial. The courts, community organizations, and private providers offer a variety of Alternative Dispute Resolution (ADR) processes to help people resolve disputes without a trial. The San Diego Superior Court expects that litigants will utilize some form of ADR as a mechanism for case settlement before trial, and it may be beneficial to do this early in the case.

Below is some information about the potential advantages and disadvantages of ADR, the most common types of ADR, and how to find a local ADR program or neutral. A form for agreeing to use ADR is attached (SDSC form #CIV-359).

Potential Advantages and Disadvantages of ADR

ADR may have a variety of advantages or disadvantages over a trial, depending on the type of ADR process used and the particular case:

Potential Advantages

- Saves time
- Saves money
- Gives parties more control over the dispute resolution process and outcome
- Preserves or improves relationships

Potential Disadvantages

- May take more time and money if ADR does not resolve the dispute
- Procedures to learn about the other side's case (discovery), jury trial, appeal, and other court protections may be limited or unavailable

Most Common Types of ADR

You can read more information about these ADR processes and watch videos that demonstrate them on the court's ADR webpage at <http://www.sdscourt.ca.gov/adr>.

Mediation: A neutral person called a "mediator" helps the parties communicate in an effective and constructive manner so they can try to settle their dispute. The mediator does not decide the outcome, but helps the parties to do so. Mediation is usually confidential, and may be particularly useful when parties want or need to have an ongoing relationship, such as in disputes between family members, neighbors, co-workers, or business partners, or when parties want to discuss non-legal concerns or creative resolutions that could not be ordered at a trial.

Settlement Conference: A judge or another neutral person called a "settlement officer" helps the parties to understand the strengths and weaknesses of their case and to discuss settlement. The judge or settlement officer does not make a decision in the case but helps the parties to negotiate a settlement. Settlement conferences may be particularly helpful when the parties have very different ideas about the likely outcome of a trial and would like an experienced neutral to help guide them toward a resolution.

Arbitration: A neutral person called an "arbitrator" considers arguments and evidence presented by each side and then decides the outcome of the dispute. Arbitration is less formal than a trial, and the rules of evidence are usually relaxed. If the parties agree to binding arbitration, they waive their right to a trial and agree to accept the arbitrator's decision as final. With nonbinding arbitration, any party may reject the arbitrator's decision and request a trial. Arbitration may be appropriate when the parties want another person to decide the outcome of their dispute but would like to avoid the formality, time, and expense of a trial.

Other ADR Processes: There are several other types of ADR which are not offered through the court but which may be obtained privately, including neutral evaluation, conciliation, fact finding, mini-trials, and summary jury trials. Sometimes parties will try a combination of ADR processes. The important thing is to try to find the type or types of ADR that are most likely to resolve your dispute. Be sure to learn about the rules of any ADR program and the qualifications of any neutral you are considering, and about their fees.

Local ADR Programs for Civil Cases

Mediation: The San Diego Superior Court maintains a Civil Mediation Panel of approved mediators who have met certain minimum qualifications and have agreed to charge \$150 per hour for each of the first two (2) hours of mediation and their regular hourly rate thereafter in court-referred mediations.

On-line mediator search and selection: Go to the court's ADR webpage at www.sdcourt.ca.gov/adr and click on the "Mediator Search" to review individual mediator profiles containing detailed information about each mediator including their dispute resolution training, relevant experience, ADR specialty, education and employment history, mediation style, and fees and to submit an on-line Mediator Selection Form (SDSC form #CIV-005). The Civil Mediation Panel List, the Available Mediator List, individual Mediator Profiles, and Mediator Selection Form (CIV-005) can also be printed from the court's ADR webpage and are available at the Mediation Program Office or Civil Business Office at each court location.

Settlement Conference: The judge may order your case to a mandatory settlement conference, or voluntary settlement conferences may be requested from the court if the parties certify that: (1) settlement negotiations between the parties have been pursued, demands and offers have been tendered in good faith, and resolution has failed; (2) a judicially supervised settlement conference presents a substantial opportunity for settlement; and (3) the case has developed to a point where all parties are legally and factually prepared to present the issues for settlement consideration and further discovery for settlement purposes is not required. Refer to SDSC Local Rule 2.2.1 for more information. To schedule a settlement conference, contact the department to which your case is assigned.

Arbitration: The San Diego Superior Court maintains a panel of approved judicial arbitrators who have practiced law for a minimum of five years and who have a certain amount of trial and/or arbitration experience. Refer to SDSC Local Rules Division II, Chapter III and Code Civ. Proc. § 1141.10 et seq or contact the Arbitration Program Office at (619) 450-7300 for more information.

More information about court-connected ADR: Visit the court's ADR webpage at www.sdcourt.ca.gov/adr or contact the court's Mediation/Arbitration Office at (619) 450-7300.

Dispute Resolution Programs Act (DRPA) funded ADR Programs: The following community dispute resolution programs are funded under DRPA (Bus. and Prof. Code §§ 465 et seq.):

- In Central, East, and South San Diego County, contact the National Conflict Resolution Center (NCRC) at www.ncrconline.com or (619) 238-2400.
- In North San Diego County, contact North County Lifeline, Inc. at www.nclifeline.org or (760) 726-4900.

Private ADR: To find a private ADR program or neutral, search the Internet, your local telephone or business directory, or legal newspaper for dispute resolution, mediation, settlement, or arbitration services.

Legal Representation and Advice

To participate effectively in ADR, it is generally important to understand your legal rights and responsibilities and the likely outcomes if you went to trial. ADR neutrals are not allowed to represent or to give legal advice to the participants in the ADR process. If you do not already have an attorney, the California State Bar or your local County Bar Association can assist you in finding an attorney. Information about obtaining free and low cost legal assistance is also available on the California courts website at www.courtinfo.ca.gov/selfhelp/lowcost.

SUPERIOR COURT OF CALIFORNIA, COUNTY OF SAN DIEGO STREET ADDRESS: 330 W Broadway MAILING ADDRESS: 330 W Broadway CITY AND ZIP CODE: San Diego CA 92101-3827 BRANCH NAME: Central	<i>FOR COURT USE ONLY</i>
Short Title: Diarkop vs. Ford Motor Company	
NOTICE OF CONFIRMATION OF ELECTRONIC FILING	CASE NUMBER: <div style="background-color: black; width: 100px; height: 15px;"></div>

San Diego Superior Court has reviewed the electronic filing described below. The fee assessed for processing and the filing status of each submitted document are also shown below.

Electronic Filing Summary Data

Electronically Submitted By: Douglas Law
 On Behalf of:
 Transaction Number:
 Court Received Date: 11/09/2018
 Filed Date: 11/09/2018
 Filed Time: 08:23 AM
 Fee Amount Assessed: \$435.00
 Case Number:
 Case Title: vs. Ford Motor Company
 Location: Central
 Case Type: Breach of Contract/Warranty
 Case Category: Civil - Unlimited
 Jurisdictional Amount: > 25000

Status

Documents Electronically Filed/Received

Accepted: Complaint
 Accepted: Civil Case Cover Sheet
 Accepted: Original Summons

Comments

Clerk's Comments:

Events Scheduled

Hearing(s)	Date	Time	Location	Department
Civil Case Management Conference	04/19/2019	01:30 PM	Central	C-71

Electronic Filing Service Provider Information

Service Provider: OneLegal
 Email: support@onelegal.com

Contact Person:
Phone:

Customer Support
(800) 938-8815

Douglas D. Law
doug@lemongone.com

***The Law Offices of
Douglas D. Law, Esq.***

Attorney at Law
13223 Black Mountain Road, Suite 430
San Diego, California 92129
PH: (858) 704-8110 • FAX: (858) 704-7954
Toll Free: (877) 348-1152
<http://californialemonlawguide.com>

Jessica Bernardo
Legal Assistant
jessica@lemongone.com

NOTICE

Our office has become completely paperless, we ask that you serve all correspondence, pleadings, requests and documents either electronically to: jessica@lemongone.com and doug@lemongone.com (Governing the rules of CRC section 2.251) or by compact disc or flash drive. ***Please do not mail hard copies.***

Thank you for your cooperation.

1 **The Law Offices of Douglas D. Law, Esq.**
2 Douglas D. Law, SBN: 110829
3 13223 Black Mountain Road, Suite 430
4 San Diego, California 92129
5 858 704-8110 (Tel)
6 858 704-7954 (Fax)

7 Attorney for Plaintiff.

ELECTRONICALLY FILED
Superior Court of California,
County of San Diego
11/09/2018 at 08:23:31 AM
Clerk of the Superior Court
By Maria Acevedo, Deputy Clerk

8 SUPERIOR COURT OF THE STATE OF CALIFORNIA
9 FOR THE COUNTY OF SAN DIEGO

10 [REDACTED]
11 [REDACTED] an individual,
12 Plaintiff,
13 v.
14 FORD MOTOR COMPANY, a corporation;
15 PENSKE FORD, an entity, form unknown;
16 and DOES 1 through 10, inclusive,
17 Defendants.

CASE NO. [REDACTED]

COMPLAINT FOR RESTITUTION
AND DAMAGES:

1. VIOLATION OF THE SONG - BEVERLY CONSUMER WARRANTY ACT
2. VIOLATION OF MAGNUSON - MOSS WARRANTY ACT

18 Plaintiff [REDACTED] alleges as follows against defendants on information
19 and belief, formed after an inquiry reasonable under the circumstances:

20 GENERAL ALLEGATIONS

- 21 1. Plaintiff [REDACTED] is an individual residing in the City of Campo,
22 County of San Diego, State of California.
- 23 2. Defendant Ford Motor Company is and was a corporation doing business in
24 the State of California, City of La Mesa, County of San Diego.
- 25 3. Defendant Penske Ford is and was operating as an automobile dealership
26 doing business in the State of California, City of La Mesa, County of San Diego.
- 27 4. Plaintiff does not know the true names and capacities, whether corporate,
28 partnership, associate, individual or otherwise of defendants sued herein as Does 1 through

1 10, inclusive, under the provisions of section 474 of the California Code of Civil Procedure.
2 Defendants Does 1 through 10, inclusive, are in some manner responsible for the acts,
3 occurrences and transactions set forth herein, and are legally liable to plaintiff. Plaintiff will
4 seek leave to amend this Complaint to set forth the true names and capacities of the
5 fictitiously named defendants together with appropriate charging allegations when
6 ascertained.

7 5. All acts of defendants' employees as alleged were authorized or ratified by an
8 officer, director or managing agent of the defendant employer.

9 6. Each defendant whether actually or fictitiously named herein, was the
10 principal, agent (actual or ostensible) or employee of each other defendant and in acting as
11 such principal or within the course and scope of such employment or agency, took some
12 part in the acts and omissions hereinafter set forth by reason of which each defendant is
13 liable to plaintiff for the relief prayed for herein.

14 7. On November 4, 2016 plaintiff purchased a used 2016 Ford Explorer, vehicle
15 identification number: 1FM5K8GT0GC [REDACTED] (the "vehicle") from Penske Ford. Defendants'
16 express warranties accompanied the sale of the vehicle to plaintiff by which defendants
17 undertook to preserve or maintain the utility or performance of plaintiff's vehicle or provide
18 compensation if there was a failure in such utility or performance.

19 8. The vehicle was delivered to plaintiff with material defects and nonconformities
20 to warranty and developed other material defects and nonconformities to warranty including,
21 but not limited to: check engine light coming on; grey smoke from exhaust; defective fuel
22 gauge; engine hesitation; and carbon monoxide smell inside vehicle.

23 **FIRST CAUSE OF ACTION**

24 (Violation of the Song-Beverly Consumer Warranty Act).

25 9. Plaintiff incorporates by reference each and every allegation set forth in
26 paragraphs 1 through 8, inclusive, of this Complaint.

27 10. Pursuant to the Song-Beverly Consumer Warranty Act (hereinafter the "Act")
28 Civil Code sections 1790 *et. seq.*, the vehicle constitutes "consumer goods" purchased

1 primarily for family or household purposes and plaintiff has used the vehicle primarily for
2 those purposes.

3 11. Plaintiff is a "buyer" of consumer goods under the Act.

4 12. Defendant Ford Motor Company is a "manufacturer" and/or "distributor" under
5 the Act.

6 13. Defendant Penske Ford is a "seller" and "retailer" under the Act.

7 14. In addition to the express warranties, the sale of the vehicle to plaintiff was
8 accompanied by an implied warranty that the vehicle was merchantable and was also
9 accompanied by defendants' implied warranty of fitness.

10 15. The foregoing defects and nonconformities to warranty manifested themselves
11 within the applicable express warranty period. The nonconformities substantially impair the
12 use, value and/or safety of the vehicle.

13 16. Plaintiff delivered the vehicle to defendants for repair of the nonconformities
14 on numerous occasions.

15 17. Defendants were unable to conform plaintiff's vehicle to the applicable express
16 and implied warranties after a reasonable number of attempts.

17 18. Notwithstanding plaintiff's entitlement, defendants have refused plaintiff's
18 demands for a refund or replacement.

19 19. By failure of defendants to remedy the defects as alleged above, or to issue
20 a refund or replacement, defendants are in breach of their obligations under the Act.

21 20. Plaintiff is also entitled to revoke acceptance of the vehicle which plaintiff has
22 done reasonably and timely.

23 21. Under the Act, plaintiff is entitled to reimbursement of the purchase price paid
24 for the vehicle less that amount directly attributable to use by the plaintiff prior to discovery
25 of the nonconformities.

26 22. Plaintiff is entitled to all incidental, consequential, general and special
27 damages resulting from defendants' failure to comply with their obligations under the Act.
28

1
2
3
4
5
6
7
8
9
10
11
12
13
14
15
16
17
18
19
20
21
22
23
24
25
26
27
28

33. Under 15 U.S.C. § 2310(d)(2), plaintiff is entitled to recover as part of the judgment, costs and expenses of the suit including reasonable attorney's fees based on actual time expended. Plaintiff has incurred and continues to incur legal fees, costs and expenses in connection with the commencement and prosecution of this action.

WHEREFORE, plaintiff prays for judgment against defendants, as follows:

1. For general, special and actual damages according to proof at trial;
2. For rescission of the sale contract and restitution of all monies expended;
3. For incidental and consequential damages according to proof at trial;
4. For a civil penalty in the amount of two times plaintiff's actual damages;
5. For prejudgment interest at the legal rate;
6. For reasonable attorney's fees and costs of suit; and
7. For such other and further relief as the Court deems just and proper under the circumstances.

DATED: November 9, 2018

The Law Offices of Douglas D. Law, Esq.
Attorney for Plaintiff

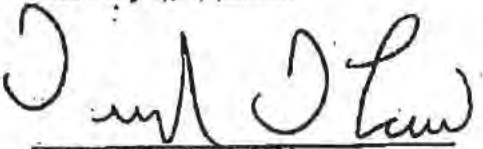
By: 
DOUGLAS D. LAW

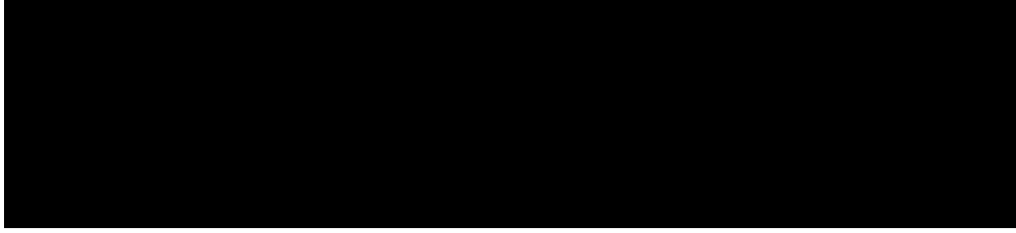

D174440 CS CA

SAGE LAW GROUP

LLP

450 N. Brand Boulevard, Suite 600 | Glendale, California 91203
(310) 651-8485 Telephone | (310) 651-8923 Fax

sally@sagelawgroupllp.com

November 16, 2018

FORD MOTOR COMPANY
Customer Relations Department
Post Office Box 6248
Dearborn, Michigan 48121

RECEIVED

NOV 20 2018

Re: [REDACTED], Ford Motor Company
Vehicle : 2013 Ford Explorer
VIN# : 1FM5K7D84D [REDACTED]
Our File No. [REDACTED]

SETTLEMENT CORRESPONDENCE PROTECTED FROM USE PURSUANT TO
CALIFORNIA EVIDENCE CODE §1115-19; 1152-54 ET SEQ.

Dear Sir or Madam:

Please be advised that our office has been retained by [REDACTED] with regard to purchase of the defective 2013 Ford Explorer ("Vehicle") referenced above. [REDACTED] purchased the Vehicle, on June 15, 2013, from your authorized dealership. Since taking delivery, the Vehicle has exhibited multiple problems that have substantially impaired its use, value and safety to [REDACTED] and his family. The Vehicle has suffered from defects, including, but not limited to exhaust emission defects and steering defects. These defects potentially expose [REDACTED] to lethal levels of carbon monoxide. [REDACTED] has been required to return the Vehicle to your authorized repair facilities no less than five times to address these defects. The defects have been persistent and annoying, depriving [REDACTED] of the value of his purchase.

On behalf of DAVID ANDREW GUERRERO, demand is hereby made that you now belatedly comply with your statutory obligations under the Song-Beverly Consumer Warranty Act, Civil Code Section 1793.2(d)(2). Section 1793.2(d)(2) required that you affirmatively offer [REDACTED] either reimbursement of his purchase payments or a replacement vehicle. You failed to do either and thereby violated the law, necessitating [REDACTED]'s retention of our firm. Given the obvious and egregious service history for the

FORD MOTOR COMPANY

November 16, 2018

Page 2

Vehicle and multiple unsuccessful warranty repairs undertaken by your authorized repair facilities it is clear to us that your failure to make the required affirmative statutory offer to [REDACTED] was intentional and willful, justifying the imposition of a civil penalty. [REDACTED] is willing to forego seeking a civil penalty in this matter so long as you quickly and efficiently now comply with your statutory obligation by immediately providing restitution as required by the law. Should you fail to do so, a lawsuit will be filed on [REDACTED]'s behalf seeking all available statutory remedies, including a civil penalty. For avoidance of doubt, [REDACTED] hereby revokes acceptance of the Vehicle, elects to cancel the purchase agreement and seeks full restitution and damages under Civil Code Sections 1791.1(d), 1792, 1793.2(b) and (d)(2).

Finally, [REDACTED] expects to be reimbursed for attorneys fees and costs necessitated by having to retain counsel to enforce his rights and seek recovery that should have been affirmatively offered to him by law. Assuming you intend to otherwise comply with [REDACTED]'s demands, we will be happy to discuss our attorneys' fees and costs with you and arrive at a fair and reasonable resolution.

Please do not seek to contact [REDACTED] directly. All further communications regarding this matter need to be addressed to our office. If we do not hear from you within thirty (30) days, we will file suit against you on [REDACTED]'s behalf and seek all available relief under the law.

Very truly yours,

Sally A. Ayvazian
SAGE LAW GROUP LLP

Enclosures: Repair Orders

CUSTOMER #:

AutoNation

AutoNation Toyota Cerritos
AutoNation Scion Cerritos

INVOICE

Cerritos Auto Square
18700 Studebaker Rd. Cerritos, CA 90703-6375
Phone: (562) 402-2783
Fax: (562) 484-6369

DOWNEY, CA

PAGE 1

HOME:

BUS:

SERVICE ADVISOR: 8655 MARGARET KANG

COLOR	YEAR	MAKE/MODEL	VIN	LICENSE	MILEAGE IN/OUT	TAG
STERLING G	13	FORD EXPLORER	1FM5K7D84D		1185/1186	

DEL. DATE	PROD. DATE	WARR. EXP.	PROMISED	PC NO.	RATE	PAYMENT	INV. DATE
15JUN13 DD			16:00 11JUL13			CASH	11JUL13

R.O. OPENED	READY	OPTIONS:
14:35 11JUL13	15:43 11JUL13	STK:DGC44915 DLR:30956 ENG:3.5L_V6_Cyl TRN:A

LINE	OPCODE	TECH	TYPE	HOURS	LIST	NET	TOTAL
A FIRST SERVICE APPOINTMENT							
FSA FIRST SERVICE APPOINTMENT							
	1227	CT				0.00	0.00
LA1ST FIRST SERVICE							
	1227	CT				0.00	0.00
PARTS:	0.00	LABOR:	0.00	OTHER:	0.00	TOTAL LINE A:	0.00
1186							

B CUSTOMER STATES RIGHT FRONT TIRE HAS A NAIL							
46 WHEEL/TIRES - 46							
	1227	TIREPN				(N/C)	(N/C)
1 PLUGNPATCH TIRE PATCH							
	1227	CT				0.00	0.00
PARTS:	0.00	LABOR:	0.00	OTHER:	0.00	TOTAL LINE B:	0.00
1186							

C Customer declined to have Multi Point Inspection performed this visit							
MULTI-D Customer declined to have Multi Point Inspection performed this visit							
	1227	CT				0.00	0.00
GTIRE GREEN-TIRE Inspected tires and Okay							
	1227	CT				0.00	0.00
DS10 THANK YOU FOR COMING IN TODAY, DAVID!							
	1227	CT				0.00	0.00
PARTS:	0.00	LABOR:	0.00	OTHER:	0.00	TOTAL LINE C:	0.00
1186							

D Customer states perform courtesy car wash.							
WASH Customer states perform courtesy car wash.							
	1227	CT					
PARTS:	0.00	LABOR:	0.00	OTHER:	0.00	TOTAL LINE D:	
1186							

NO CLAIMS WITHOUT THIS INVOICE
 (**HAZARDOUS MATERIAL) THERE WILL BE A REMOVAL CHARGE FOR ALL HAZARDOUS MATERIALS REMOVED FROM YOUR AUTOMOBILE, THAT MUST BE DISPOSED OF AS A HAZARDOUS WASTE. SECTION 262.12 OF TITLE 40 OF CODE OF FED. REG.
 ALL PARTS INSTALLED ARE NEW UNLESS SPECIFIED OTHERWISE.
 By law, you may choose another licensed Smog Check facility to perform any needed repairs or adjustments that the Smog Check test indicates are necessary.
 I ACKNOWLEDGE NOTICE AND ORAL APPROVAL OF AN INCREASE IN THE ORIGINAL ESTIMATED PRICE.
 CUSTOMER SIGNATURE _____

SERVICE HOURS
 MONDAY - FRIDAY
 7:00 A.M. - 7:00 P.M.
 SATURDAY
 7:00 A.M. - 6:00 P.M.

 PRESIDENT'S AWARD

DESCRIPTION	TOTALS
LABOR AMOUNT	0.00
PARTS AMOUNT	0.00
GAS, OIL, LUBE	0.00
SUBLET AMOUNT	0.00
MISC. CHARGES	0.00
TOTAL CHARGES	0.00
LESS INSURANCE	0.00
SALES TAX	0.00
PLEASE PAY THIS AMOUNT	0.00

Notice to Consumer: Please read important information on back.
 CUSTOMER COPY

LIMITED WARRANTY FOR TOYOTA PARTS OR ACCESSORIES

TOYOTA warrants that it will either provide a replacement part or repair any TOYOTA part or accessory that is defective in material or workmanship. This warranty applies to new or remanufactured parts which are genuine or authorized TOYOTA parts. Except for those parts or accessories listed below, warranty coverage is for 12 months, regardless of mileage. If the part or accessory is installed during the New Vehicle Limited Warranty period, coverage is for the 12 months or the remainder of the applicable warranty coverage.

REPLACEMENT PART WARRANTY

TOYOTA authorized replacement parts are warranted from the date of purchase or installation for 24 months, regardless of mileage, or the remainder of any applicable new vehicle warranty, whichever provides greater coverage, and on a pro-rata basis thereof. The pro-rata amount (based on MSRP), equal to the remaining warranty up to 24 months, will be credited toward cost of a comparable Toyota replacement part, excluding taxes and labor for installation.

EXCLUDED ACCESSORIES

This warranty is not intended to be used in conjunction with any other manufacturer's warranty for details.

WHAT IS NOT COVERED

- Damage to the TOYOTA part or accessory caused by a non-genuine or unauthorized TOYOTA part or component from a third party.
- Labor to remove from vehicle and reinstallation of a part or accessory said "reverse counter" is not covered.
- Labor, parts and other costs such as: (1) labor for removal of a component if an insurance service is not covered; (2) service adjustments, such as adjustments at alignments, are not covered.
- Failures or damages resulting from improper installation, removal, repair, misuse, negligence, accident, or modification of the part or the accessory are not covered.
- This Limited Warranty does not apply where the vehicle mileage cannot be determined or has been altered, or where proof of purchase is unavailable.

INCIDENTAL OR CONSEQUENTIAL DAMAGES FOR OTHER THAN PERSONAL INJURY RESULTING FROM BREACH OF THIS WRITTEN WARRANTY OR ANY IMPLIED WARRANTY (SUCH AS TELEPHONE CALLS, LOSS OF TIME, INCONVENIENCE, OR COMMERCIAL LOSS) ARE NOT COVERED.

ANY IMPLIED WARRANTIES, INCLUDING THOSE OF MERCHANTABILITY OR FITNESS FOR A PARTICULAR PURPOSE, ARE LIMITED TO THE APPLICABLE DURATION OF THIS WRITTEN WARRANTY. SOME STATES DO NOT ALLOW LIMITATION ON HOW LONG AN IMPLIED WARRANTY LASTS OR THE EXCLUSION OR LIMITATION OF INCIDENTAL OR CONSEQUENTIAL DAMAGES, SO THE ABOVE LIMITATIONS OR EXCLUSIONS MAY NOT APPLY TO YOU.

THIS IS THE ONLY EXPRESS WARRANTY AUTHORIZED BY TOYOTA. THE PERFORMANCE OF REPAIRS OR THE REPLACEMENT OF THE PARTS ARE THE EXCLUSIVE REMEDIES UNDER THIS WARRANTY OR ANY IMPLIED WARRANTY. TOYOTA DOES NOT AUTHORIZE ANY PERSON TO CREATE FOR IT ANY OTHER OBLIGATION OR LIABILITY IN CONNECTION WITH TOYOTA PARTS OR ACCESSORIES.

This warranty gives you specific legal rights, and you may also have other rights which vary from state to state.

OWNER'S RESPONSIBILITIES

- To obtain the warranty coverage, return the part or accessory, or vehicle to which it is attached, to any authorized TOYOTA DEALER.
- Because warranty coverage periods are calculated on a time or mileage basis from the date of purchase, it is recommended that you retain proof of the purchase date and vehicle mileage at the time of purchase.

FOR MORE INFORMATION

- For more information, please call your dealership or call TOYOTA toll-free at 1-800-331-4831.
- If you would prefer to write, our address is: TOYOTA Customer Assistance Center, P.O. Box 2991, Torrance, CA 90509-2991.

STATEMENT CONCERNING AMENDMENTS TO THE SONG-BEVERLY WARRANTY ACT AS FOLLOWS:

"A buyer of this product in California has the right to have this product serviced or repaired during the warranty period. The warranty period will be extended for the number of whole days that the product has been out of the buyer's hands for warranty repairs. If a defect exists within the warranty period, the warranty will not expire until the defect has been fixed. The warranty period will also be extended if the warranty repairs have not been performed due to delays caused by circumstances beyond the control of the buyer, or if the warranty repairs did not remedy the defect and the buyer notifies the manufacturer or seller of the failure of the repairs within 60 days after they were completed. If, after a reasonable number of attempts, the defect has not been fixed, the buyer may return this product for a replacement or a refund subject, in either case, to deduction of a reasonable charge for usage. This time extension does not affect the protections or remedies the buyer has under other laws."

LIEN FOR PAYMENT OF CHARGES: The seller warrants that the buyer shall remain liable for the purchase price, and security interest in the vehicle described in the repair order to secure payment of all charges for repairs, including labor and parts, damage to existing finished under the repair order.

ALL PARTS AND SERVICES PROVIDED AS IS BY DEALERSHIP: ALL PARTS AND ACCESSORIES ARE SOLD AND ALL REPAIRS AND SERVICES ARE PROVIDED BY OUR DEALERSHIP AS IS. OUR DEALERSHIP DISCLAIMS ALL WARRANTIES, EXPRESS AND IMPLIED, INCLUDING THE IMPLIED WARRANTIES OF MERCHANTABILITY AND FITNESS FOR A PARTICULAR PURPOSE. IN CONNECTION WITH THE SALE OF PARTS AND ACCESSORIES AND/OR SERVICES AND REPAIRS PERFORMED BY OUR DEALERSHIP THE ENTIRE RISK AS TO THE QUALITY AND PERFORMANCE OF THE VEHICLE AND PARTS AND ACCESSORIES IS WITH THE CUSTOMER AND, IF APPLICABLE, THE MANUFACTURER. IF THE VEHICLE OR ANY INSTALLED PARTS OR ACCESSORIES SHOULD PROVE DEFECTIVE FOLLOWING THEIR PURCHASE, THE CUSTOMER AND POSSIBLY THE MANUFACTURER AND NOT THE DEALERSHIP ASSUME THE ENTIRE COST OF ANY NECESSARY SERVICING OR REPAIR. CUSTOMER SHALL NOT BE ENTITLED TO RECOVER FROM THE DEALERSHIP ANY CONSEQUENTIAL DAMAGES, DAMAGES TO PROPERTY, DAMAGES FOR LOSS OF USE, LOSS OF TIME, LOSS OF PROFITS OR INCOME, OR ANY OTHER INCIDENTAL DAMAGES.

HAZARDOUS WASTE DISPOSAL COSTS: A charge may be assessed to cover costs associated with the handling, management and disposal of toxic waste or hazardous substances under California and Federal Law.

TO OUR SERVICE CUSTOMERS:

- Our Dealership's usual charges for labor are based on actual technician's time, but are simply our rates for particular jobs.
- You will be charged for material not recommended unless approved by you. However, if we discover that either or additional vehicles are necessary, you will be charged for your advance approval of a revised estimate.
- Customer's hourly notified in the vehicle and if applicable, the contents are not insured for the amount of the actual cash value, interest, or otherwise, against loss, destruction, theft, or vandalism while the property remains in the Dealership's possession.
- Customer vehicle not suitable for repair, we may have to tow it to a safe place and dispose of it and return it to the repair shop.
- The repair of this vehicle may be subject to the availability of labor and parts. This Dealership is not responsible for unavailability of parts or delays in parts shipment beyond the Dealership's control.
- Due to the type of service requested, some repairs may be subject to a deposit.
- All labor and materials will be used for in-store unless Dealer agrees to other payment arrangements in advance. Material used under PAYMENT TERMS on the front of the repair order will be deemed to have been given upon receipt of the Limited Warranty, unless otherwise specified. Vehicle return to the effect addressed to the customer at the address given on the front of the repair order.
- If the vehicle described herein is not covered for either work (3) days after such notice is given, a daily storage fee will be charged.
- The Dealership is authorized to dispose of any vehicle described herein or any parts contents to any person presenting this receipt.
- In addition to any and all other legal remedies available, I authorize the Dealership to have a lien on the vehicle described herein for all charges for repairs, including labor and parts, storage and towing, and to enforce such lien. The Dealership is hereby expressly authorized to sell said vehicle at auction without giving a twenty (20) day written notice by certified mail to the legal owner, registered owner, and Department of Motor Vehicles of intent to do so. On the sale date, the vehicle shall be sold to the highest cash bidder and the proceeds of sale must be used first to satisfy the lien plus storage costs and costs incident to sale, and the balance shall be forwarded to the legal owner, or if none, to the registered owner, or if the address is unknown, it shall be forwarded to the Department of Motor Vehicles. Said expenses for sale shall also include a reasonable attorney's fees, which may be necessarily incurred.
- If any such charges remain unpaid for thirty (30) days after such request for payment, the Dealership may also refer such charges to its attorneys for collection and the customer will pay a reasonable attorney's fee.
- The Power of Attorney granted on the form of the Repair Order herein shall be irrevocable and shall remain in effect for as long as there is an outstanding amount due under the Repair Order herein.
- Remanufactured and reconditioned parts that meet manufacturer approved source part requirements may be installed at our discretion. Additional information is available upon request.
- In addition to the removal of on-board data as needed to facilitate vehicle resale, as well as sharing the data with the vehicle manufacturer for diagnostic and research purposes.

State of California - Department of Consumer Affairs: NOTICE TO MOTORISTS:

If your vehicle fails Smog Check, Federal law requires you to make necessary repairs to reduce your vehicle's emissions to required levels. If your vehicle is not under warranty and you have spent less than or more than the amount required by law for appropriate emissions-related repairs at a licensed Smog Check repair facility, you may be eligible for a one-time waiver. Repair waivers will not be issued to:

- vehicles with missing, modified or discontinued emissions control equipment, regardless of the costs to make repairs;
- vehicles identified as "Gross Polluters" - vehicles which have much higher emissions than properly maintained vehicles in their class;
- vehicles that obtained a repair waiver after January 1, 1995, in their most recent biennial inspection or transfer of ownership.

Two consecutive repair waivers will not be issued after January 1, 1995.

For more information, call the Department of Consumer Affairs toll-free at 1-800-952-6210.

BY LAW, YOU MAY CHOOSE ANOTHER LICENSED SMOG CHECK FACILITY TO PERFORM ANY NEEDED REPAIRS OR ADJUSTMENTS WHICH THE SMOG CHECK TEST INDICATES ARE NECESSARY.

TOYOTA is a Toyota Motor Sales, U.S.A., Inc. (a California corporation), for the purpose of warranty in the United States mainland.

WARNING

Motor vehicles contain chemicals known to the State of California to cause cancer and birth defects or other reproductive harm. These chemicals are contained in many vehicle components and replacement parts, vehicle fluids, and paints and materials used to maintain vehicles, including, but not limited to, fuel, oil, batteries, brakes, and wheel balancing weights. When you service, clean or maintain your car, you will be exposed to listed chemicals contained in used oil, waste and replacement fluids, fumes, grease, grime, touch-up paint, certain replacement parts, and particulates from component wear. When we service your car, we will return used components to you upon request. Used parts and components contain chemicals known to the State of California to cause cancer and birth defects or other reproductive harm.

To minimize your exposure when servicing, maintaining or cleaning your vehicle: 1) work in a well ventilated area; 2) do not smoke, drink or eat while working; 3) wash your hands when finished or when taking a break; and 4) follow all manufacturer instructions pertaining to proper use and maintenance of motor vehicles and vehicle components.

(Posted in accordance with Proposition 65 in Cal. Health & Safety Code § 25249.5 (a)(4))

AutoNation Toyota Scion Cerritos

BAR#:

18700 Studebaker Road • Cerritos, CA 90703 • Phone: 562-402-2783 **2303**

Customer's Name: [Redacted]
 Address: [Redacted]
 Home/Work Phone: _____ Cell Phone: [Redacted]
 E-Mail Address: _____
 VIN# **D9C** [Redacted]

- DAMAGE**
- C - Chips
 - Scratch
 - Dent
 - Missing
 - Tear
 - G - Glass
 - Damage

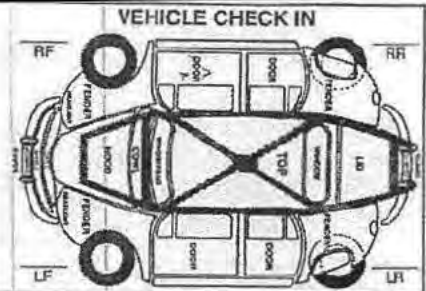

YEAR: _____ MAKE: **FORD** MODEL: _____ COLOR: **gray**
 DATE: _____ TIME: _____ MILEAGE IN: **34572** LICENSE #: _____
 INTENDED PAYMENT METHOD: Cash Check Credit Card Other
 COURTESY INSPECTION APPROVED YES NO

A. CONCERN: UCP	EST \$ _____
B. CONCERN: MPT	EST \$ _____
C. CONCERN:	EST \$ _____

PROMISED: _____ ADVISOR'S PHONE#: **DRYAN** RO #: _____ TAG #: _____

ESTIMATE: OUR DEALERSHIP WILL PROVIDE YOU WITH AN ESTIMATE OF THE COST OF REPAIRS AND, IF NECESSARY, AN ESTIMATE OF THE COST TO COMPLETE DIAGNOSTIC WORK. PLEASE INITIAL BESIDE THE KIND OF ESTIMATE YOU WANT TO RECEIVE AND PROVIDE A TELEPHONE NUMBER, FAX NUMBER, OR E-MAIL ADDRESS WHERE YOU CAN BE REACHED IF NECESSARY.

_____ WRITTEN ESTIMATE _____ ORAL ESTIMATE _____ ELECTRONIC ESTIMATE
 By Telephone at: _____ By Fax to: _____ By E-Mail to: _____

DESIGNATION OF PERSON TO AUTHORIZE ADDITIONAL WORK OR PARTS. I hereby designate the individual named below to authorize any additional work not specified or parts not included in the original written estimated price for parts and labor:

Name of Designee: _____ Phone Number: _____
 Fax Number: _____ E-Mail Address: _____
 Customer: _____ Date: _____

PARTS: I understand that the Dealership is not responsible for any delays caused by the unavailability of parts or shipping by the supplier or transporter. All parts installed will be new unless otherwise indicated. You may inspect all parts removed from the vehicle upon request. If our Dealership does not have to return the parts to the manufacturer or distributor under a warranty arrangement and they are not exempt due to their size, weight or other factors, they will be returned to you upon request. Save Replaced Parts _____ (INITIAL)

AS-IS WARRANTY DISCLAIMER: ALL PARTS AND ACCESSORIES ARE SOLD AND ALL REPAIRS AND SERVICES ARE PROVIDED BY OUR DEALERSHIP AS-IS. OUR DEALERSHIP DISCLAIMS ALL WARRANTIES, EXPRESS AND IMPLIED, INCLUDING THE IMPLIED WARRANTIES OF MERCHANTABILITY AND FITNESS FOR A PARTICULAR PURPOSE, IN CONNECTION WITH THE SALE OF PARTS AND ACCESSORIES AND/OR SERVICES AND REPAIRS PERFORMED BY OUR DEALERSHIP. THE ENTIRE RISK AS TO THE QUALITY AND PERFORMANCE OF THE VEHICLE AND PARTS AND ACCESSORIES IS WITH THE CUSTOMER AND, IF APPLICABLE, THE MANUFACTURER. IF THE VEHICLE OR ANY INSTALLED PARTS OR ACCESSORIES SHOULD PROVE DEFECTIVE FOLLOWING THEIR PURCHASE, THE CUSTOMER AND POSSIBLY THE MANUFACTURER AND NOT THE DEALERSHIP ASSUME THE ENTIRE COST OF ANY NECESSARY SERVICING OR REPAIR. CUSTOMER SHALL NOT BE ENTITLED TO RECOVER FROM THE DEALERSHIP ANY CONSEQUENTIAL DAMAGES, DAMAGES TO PROPERTY, DAMAGES FOR LOSS OF USE, LOSS OF TIME, LOSS OF PROFITS, OR INCOME, OR ANY OTHER INCIDENTAL DAMAGES.

TERMS OF PAYMENT: I agree to pay for all labor and materials in Cash (unless the Dealership agrees to other payment arrangements in advance) simultaneously with delivery of the vehicle to me or within 3 days after receiving notice that the vehicle is ready to be picked up. If disassembly of the vehicle or a vehicle component is needed to provide an estimate or repairs are commenced and I do not authorize completion of a repair or service, I understand that a charge will be imposed for disassembly, reassembly or partially completed work and I agree to pay the same. Such charges will be directly related to the actual amount of labor or parts involved in the inspection, repair or service. You will be notified in advance if disassembly of the vehicle may prevent restoration of the vehicle. I understand that a charge will be assessed to cover costs associated with the handling, management and disposal of toxic waste and hazardous substances under California and Federal Law. An express mechanic's lien is hereby acknowledged on the above vehicle to secure the cost of labor, materials, storage and/or towing charges.

I authorize the retrieval of on-board data as needed to facilitate vehicle repair, as well as sharing of that data with the manufacturer for diagnostic and research purposes. I hereby grant the Dealership permission to operate the vehicle on streets, highways or public roadways for the purpose of testing and/or inspecting the vehicle and acknowledge that the Dealership is not responsible for loss or damage to the vehicle or articles left in the vehicle in case of fire, theft or any other cause beyond its control.

CUSTOMER SIGNATURE: [Redacted] DATE: / / TIME: _____ am/pm

NOTICE TO CONSUMER: PLEASE READ IMPORTANT INFORMATION ON REPAIR ORDER AND/OR REPAIR INVOICE.
 SR-ANCA-HW560 (Rev. 9/13) TO REORDER CALL 866-268-9581 #764670

LIMITED WARRANTY

FOR TOYOTA PARTS OR ACCESSORIES

WHAT IS COVERED:

- TOYOTA* warrants that it will either provide a replacement part or repair any TOYOTA part or accessory that is defective in material or workmanship. This warranty applies to new or remanufactured parts which are genuine or authorized TOYOTA parts. Except for those parts or accessories listed below, warranty coverage is for 12 months, regardless of mileage. If the part or accessory is installed during the New Vehicle Limited Warranty period, coverage is for the 24 months or the remainder of the applicable warranty coverage.

COVERAGE OTHER THAN 12 MONTHS REGARDLESS OF MILEAGE:

BATTERY LIMITED WARRANTY:

- TOYOTA authorized replacement batteries are warranted from the date of purchase or installation for 24 months, regardless of mileage, or the remainder of any applicable new vehicle warranty, whichever provides greater coverage, and on a prorated basis thereafter. The prorated amount (based on MSRP), equal to the remaining warranty up to 24 months, will be credited toward that of a comparable Toyota replacement battery, excluding taxes and labor for installation.

TIRE LIMITED WARRANTY:

- Tires are warranted independently by the tire manufacturer. See manufacturer's statement for details.

WHAT IS NOT COVERED:

- Damage to the TOYOTA part or accessory caused by a non-genuine or unauthorized TOYOTA part or component is not covered.
- Labor for removal from vehicle and reinstallation of a part or accessory sold "over-the-counter" is not covered.
- Labor, parts, and other costs (such as all lubricants) connected with recommended maintenance are not covered. Service adjustments, such as calibration or alignments, are not covered.
- Failures or damages resulting from improper installation, removal, repair, misuse, negligence, accidents, or modification of the part or the accessory are not covered.

STATEMENT CONCERNING AMENDMENTS TO THE SONG-BEVERLY WARRANTY ACT AS FOLLOWS:

"A buyer of this product in California has the right to have this product serviced or repaired during the warranty period. The warranty period will be extended for the number of whole days that the product has been out of the buyer's hands for warranty repairs. If a defect exists within the warranty period, the warranty will not expire until the defect has been fixed. The warranty period will also be extended if the warranty repairs have not been performed due to delays caused by circumstances beyond the control of the buyer, or if the warranty repairs did not remedy the defect and the buyer notifies the manufacturer or seller of the failure of the repairs within 60 days after they were completed. If, after a reasonable number of attempts, the defect has not been fixed, the buyer may return this product for a replacement or a refund subject, in either case, to deduction of a reasonable charge for usage. This time extension does not affect the protections or remedies the buyer has under other laws."

LIEN FOR PAYMENT OF CHARGES: The undersigned customer and/or legal owner hereby grant to the dealer a lien upon, and security interest in, the vehicle described in this repair order to secure payment of all charges for repairs, including labor and parts, storage and towing, furnished under this repair order.

ALL PARTS AND SERVICE PROVIDED AS IS BY DEALERSHIP: ALL PARTS AND ACCESSORIES ARE SOLD AND ALL REPAIRS AND SERVICES ARE PROVIDED BY OUR DEALERSHIP AS IS. OUR DEALERSHIP DISCLAIMS ALL WARRANTIES, EXPRESS AND IMPLIED, INCLUDING THE IMPLIED WARRANTIES OF MERCHANTABILITY AND FITNESS FOR A PARTICULAR PURPOSE, IN CONNECTION WITH THE SALE OF PARTS AND ACCESSORIES AND/OR SERVICES AND REPAIRS PERFORMED BY OUR DEALERSHIP. THE ENTIRE RISK AS TO THE QUALITY AND PERFORMANCE OF THE VEHICLE AND PARTS AND ACCESSORIES IS WITH THE CUSTOMER AND, IF APPLICABLE, THE MANUFACTURER. IF THE VEHICLE OR ANY INSTALLED PARTS OR ACCESSORIES SHOULD PROVE DEFECTIVE FOLLOWING THEIR PURCHASE, THE CUSTOMER AND POSSIBLY THE MANUFACTURER AND NOT THE DEALERSHIP ASSUME THE ENTIRE COST OF ANY NECESSARY SERVICING OR REPAIR. CUSTOMER SHALL NOT BE ENTITLED TO RECOVER FROM THE DEALERSHIP ANY CONSEQUENTIAL DAMAGES, DAMAGES TO PROPERTY, DAMAGES FOR LOSS OF USE, LOSS OF TIME, LOSS OF PROFITS OR INCOME, OR ANY OTHER INCIDENTAL DAMAGES.

HAZARDOUS WASTE DISPOSAL COSTS: A charge may be assessed to cover costs associated with the handling, management and disposal of toxic waste or hazardous substances under California and Federal Law.

TO OUR SERVICE CUSTOMERS:

1. Our usual charges for labor are not based on actual mechanic's time, but are simply our prices for particular jobs.
2. You will be charged no more than the estimated price approved by you. However, if we discover that additional or actual repairs are indicated, you will be contacted for your advance approval of a revised estimate.
3. Customer is hereby notified that this said property is not insured or protected to the amount of the actual cash value thereof, or otherwise, against loss occasioned by theft, fire or vandalism while the property remains with the dealer.
4. Customer attests no articles of personal property have been left in the vehicle and dealer is not responsible for inspection thereof.
5. The repair of the vehicle and completion date are subject to the availability of labor and parts. Dealer is not responsible for availability of parts or delays in parts shipment beyond Dealer's control.
6. Due to the type of service requested, some repairs must be subject.
7. All charges for repairs including labor and materials furnished are due and payable simultaneously with the delivery of the within described vehicle or prior to delivery upon the expiration of three (3) days after notice that repairs have been completed. Notice shall be deemed to have been given upon the deposit in the United States mail, postage prepaid, of written notification to that effect addressed to the customer at the address given on the front side hereof.
8. If the vehicle described herein is not called for within three (3) days after such notice is given, a daily storage fee will be charged.
9. Said Dealer is authorized to deliver the vehicle described herein or any of its contents to any person presenting this receipt.
10. In addition to any and all other legal remedies available, I authorize said Dealer to have a lien on the vehicle described herein for all charges for repairs, including labor and parts, storage and/or towing, and to enforce such lien, said Dealer is hereby expressly authorized to sell said vehicle at public auction after giving a twenty (20) day written notice by certified mail to the legal owner, registered owner, and Department of Motor Vehicles of intent to do so. On the sale date, the vehicle shall be sold to the highest cash bidder and the proceeds of sale must be used first to satisfy the lien plus storage costs and costs incident to sale, and the balance shall be forwarded to the legal owner, or if none, to the registered owner, or if the address is unknown, it shall be forwarded to the Department of Motor Vehicles. Said expenses for sale shall also include a reasonable attorney's fee, which may be necessary.
11. If any such charges remain unpaid for thirty (30) days after such request for payment, said Dealer may also refer such charges to its attorneys for collection and the customer will pay a reasonable attorney's fee.
12. The Power-of-Authority granted on the front of this Repair Order/Invoice shall be irrevocable and shall remain in effect for so long as there is an outstanding amount due under this Repair Order/Invoice.

State of California - Department of Consumer Affairs: NOTICE TO MOTORISTS:

If your vehicle fails Smog Check, federal law requires you to make necessary repairs to reduce your vehicle's emissions to required levels. If your vehicle is not under warranty and you have spent up to or more than the amount required by law for appropriate emissions-related repairs at a licensed Smog Check repair facility, you may be eligible for a one-time waiver. Repair waivers will NOT be issued for: Vehicles with missing, modified or disconnected emissions control equipment, regardless of the costs to make repairs; Vehicles identified as "Gross Polluters" - vehicles which have much higher emissions than properly maintained vehicles in their class; Vehicles that obtained a repair waiver after January 1, 1995, in their most recent biennial inspection or transfer of ownership. Two consecutive repair waivers will not be issued after January 1, 1995.

If you obtain a smog certificate by means of fraud, you may be subject to a civil penalty of up to \$250 per day of subject violation. Also, you may be subject to criminal prosecution. For further information, call the Department of Consumer Affairs toll-free at 1-800-952-5210.

BY LAW, YOU MAY CHOOSE ANOTHER LICENSED SMOG CHECK FACILITY TO PERFORM ANY NEEDED REPAIRS OR ADJUSTMENTS WHICH THE SMOG CHECK TEST INDICATES ARE NECESSARY.

*TOYOTA is Toyota Motor Sales, U.S.A., Inc. (a California corporation), for the purpose of warranty in the United States mainland.

WARNING

Motor vehicles contain chemicals known to the State of California to cause cancer and birth defects or other reproductive harm. These chemicals are contained in many vehicle components and replacement parts, vehicle fluids, and paints and materials used to maintain vehicles, including, but not limited to, fuel, oil, batteries, brakes, and wheel balancing weights. When you service, clean or maintain your car, you will be exposed to listed chemicals contained in used oil, waste and replacement fluids, fumes, grease, grime, touch-up paint, certain replacement parts, and particulates from component wear. When we service your car, we will return used components to you upon request. Used parts and components contain chemicals known to the State of California to cause cancer and birth defects or other reproductive harm.

To minimize your exposure when servicing, maintaining or cleaning your vehicle: 1) work in a well ventilated area; 2) do not smoke, drink or eat while working; 3) wash your hands when finished or when taking a break; and 4) follow all manufacturer instructions pertaining to proper use and maintenance of motor vehicles and vehicle components.

(Posted in accordance with Proposition 65 in Cal. Health & Safety Code 82524.9.5 et seq.)

AutoNation Toyota Cerritos

18700 Studebaker Road • Cerritos, CA 90703 • Phone: 562-402-2700

Customer's Name:	[Redacted]	C - Chips S - Scratch D - Dent M - Missing T - Tear G - Glass Damage	
Address:	[Redacted]		
Home/Work Phone:	[Redacted]		
Cell Phone:	[Redacted]		
E-Mail Address:	[Redacted]		
VIN#	[Redacted]		

YEAR:	MAKE:	MODEL:	COLOR:
	Ford	230	Green
DATE:	TIME:	MILEAGE IN:	LICENSE #:
7/11/13	2:30	1185.5	
INTENDED PAYMENT METHOD: <input type="checkbox"/> Cash <input type="checkbox"/> Check <input type="checkbox"/> Credit Card <input type="checkbox"/> Other			COURTESY INSPECTION APPROVED <input type="checkbox"/> YES <input type="checkbox"/> NO

A. CONCERN: US Right front tire has a nail

EST \$ _____

B. CONCERN: Oil service & filter

EST \$ _____

C. CONCERN: Wash

EST \$ _____

PROMISED:	ADVISOR:	RO #:	TAG #:
4/1/13	MARAVOT		

ESTIMATE: OUR DEALERSHIP WILL PROVIDE YOU WITH AN ESTIMATE OF THE COST OF REPAIRS AND, IF NECESSARY, AN ESTIMATE OF THE COST TO COMPLETE DIAGNOSTIC WORK. PLEASE INITIAL BESIDE THE KIND OF ESTIMATE YOU WANT TO RECEIVE AND PROVIDE A TELEPHONE NUMBER, FAX NUMBER, OR E-MAIL ADDRESS WHERE YOU CAN BE REACHED IF NECESSARY.

WRITTEN ESTIMATE
 ORAL ESTIMATE
 ELECTRONIC ESTIMATE

By Telephone at: _____
 By Fax to: _____
 By E-Mail to: _____

DESIGNATION OF PERSON TO AUTHORIZE ADDITIONAL WORK OR PARTS. I hereby designate the individual named below to authorize any additional work not specified or parts not included in the original written estimated price for parts and labor:

Name of Designee:	Phone Number:
Fax Number:	E-Mail Address:
Customer:	Date:

PARTS: I understand that the Dealership is not responsible for any delays caused by the unavailability of parts or shipping by the supplier or transporter. All parts installed will be new unless otherwise indicated. You may inspect all parts removed from the vehicle upon request. If our Dealership does not have to return the parts to the manufacturer or distributor under a warranty arrangement and they are not exempt due to their size, weight or other factors, they will be returned to you upon request. Save Replaced Parts _____ (INITIAL)

AS-IS WARRANTY DISCLAIMER: ALL PARTS AND ACCESSORIES ARE SOLD AND ALL REPAIRS AND SERVICES ARE PROVIDED BY OUR DEALERSHIP AS-IS. OUR DEALERSHIP DISCLAIMS ALL WARRANTIES, EXPRESS AND IMPLIED, INCLUDING THE IMPLIED WARRANTIES OF MERCHANTABILITY AND FITNESS FOR A PARTICULAR PURPOSE, IN CONNECTION WITH THE SALE OF PARTS AND ACCESSORIES AND/OR SERVICES AND REPAIRS PERFORMED BY OUR DEALERSHIP. THE ENTIRE RISK AS TO THE QUALITY AND PERFORMANCE OF THE VEHICLE AND PARTS AND ACCESSORIES IS WITH THE CUSTOMER AND, IF APPLICABLE, THE MANUFACTURER. IF THE VEHICLE OR ANY INSTALLED PARTS OR ACCESSORIES SHOULD PROVE DEFECTIVE FOLLOWING THEIR PURCHASE, THE CUSTOMER AND POSSIBLY THE MANUFACTURER AND NOT THE DEALERSHIP ASSUME THE ENTIRE COST OF ANY NECESSARY SERVICING OR REPAIR. CUSTOMER SHALL NOT BE ENTITLED TO RECOVER FROM THE DEALERSHIP ANY CONSEQUENTIAL DAMAGES, DAMAGES TO PROPERTY, DAMAGES FOR LOSS OF USE, LOSS OF TIME, LOSS OF PROFITS, OR INCOME, OR ANY OTHER INCIDENTAL DAMAGES.

TERMS OF PAYMENT: I agree to pay for all labor and materials in Cash (unless the Dealership agrees to other payment arrangements in advance) simultaneously with delivery of the vehicle to me or within 3 days after receiving notice that the vehicle is ready to be picked up. If disassembly of the vehicle or a vehicle component is needed to provide an estimate or repairs are commenced and I do not authorize completion of a repair or service, I understand that a charge will be imposed for disassembly, reassembly or partially completed work and I agree to pay the same. Such charges will be directly related to the actual amount of labor or parts involved in the inspection, repair or service. You will be notified in advance if disassembly of the vehicle may prevent restoration of the vehicle. I understand that a charge will be assessed to cover costs associated with the handling, management and disposal of toxic waste and hazardous substances under California and Federal Law. An express mechanic's lien is hereby acknowledged on the above vehicle to secure the cost of labor, materials, storage and/or towing charges.

I authorize the retrieval of on-board data as needed to facilitate vehicle repair, as well as sharing of that data with the manufacturer for diagnostic and research purposes. I hereby grant the Dealership permission to operate the vehicle on streets, highways or public roadways for the purpose of testing and/or inspecting the vehicle and acknowledge that the Dealership is not responsible for loss or damage to the vehicle or its contents in the vehicle in case of fire, theft or any other cause beyond its control.

CUSTOMER SIGNATURE: [Redacted] DATE: 7/11/13 TIME: _____ am/pm

NOTICE TO CONSUMER: PLEASE READ IMPORTANT INFORMATION ON REPAIR ORDER AND/OR REPAIR INVOICE.

LIMITED WARRANTY

FOR TOYOTA PARTS OR ACCESSORIES

WHAT IS COVERED:

- TOYOTA* warrants that it will either provide a replacement part or repair any TOYOTA part or accessory that is defective in material or workmanship. This warranty applies to new or remanufactured parts which are genuine or authorized TOYOTA parts. Except for those parts or accessories listed below, warranty coverage is for 12 months, regardless of mileage. If the part or accessory is installed during the New Vehicle Limited Warranty period, coverage is for the 12 months or the remainder of the applicable warranty coverage.

COVERAGE OTHER THAN 12 MONTHS REGARDLESS OF MILEAGE:

BATTERY LIMITED WARRANTY:

- TOYOTA authorized replacement batteries are warranted from the date of purchase or installation for 24 months, regardless of mileage, or the remainder of any applicable new vehicle warranty, whichever provides greater coverage, and on a prorated basis (hereafter, the prorated amount (based on MSRP), equal to the remaining warranty up to 84 months, will be credited toward that of a comparable Toyota replacement battery, excluding taxes and labor for installation.

TIRE LIMITED WARRANTY:

- Tires are warranted independently by the tire manufacturer. See manufacturer's statement for details.

WHAT IS NOT COVERED:

- Damage to the TOYOTA part or accessory caused by a non-genuine or unauthorized TOYOTA part or component is not covered.
- Labor for removal from vehicle and reinstallation of a part or accessory sold "over-the-counter" is not covered.
- Labor, parts, and other costs (such as all lubricants) connected with recommended maintenance service are not covered. Service adjustments, such as calibration or alignments, are not covered.
- Failures or damages resulting from improper installation, removal, repair, misuse, negligence, accidents, or modification of the part or the accessory are not covered.

- This Limited Warranty does not apply where the vehicle mileage cannot be determined or has been altered, or where proof of purchase is unavailable.
- INCIDENTAL OR CONSEQUENTIAL DAMAGES (FOR OTHER THAN PERSONAL INJURY) RESULTING FROM BREACH OF THIS WRITTEN WARRANTY OR ANY IMPLIED WARRANTY (SUCH AS TELEPHONE CALLS, LOSS OF TIME, INCONVENIENCE, OR COMMERCIAL LOSS) ARE NOT COVERED.
- ANY IMPLIED WARRANTIES, INCLUDING THOSE OF MERCHANTABILITY OR FITNESS FOR A PARTICULAR PURPOSE, ARE LIMITED TO THE APPLICABLE DURATION OF THIS WRITTEN WARRANTY. SOME STATES DO NOT ALLOW LIMITATION ON HOW LONG AN IMPLIED WARRANTY LASTS, OR THE EXCLUSION OR LIMITATION OF INCIDENTAL OR CONSEQUENTIAL DAMAGES, SO THE ABOVE LIMITATIONS OR EXCLUSIONS MAY NOT APPLY TO YOU.
- THIS IS THE ONLY EXPRESS WARRANTY AUTHORIZED BY TOYOTA. THE PERFORMANCE OF REPAIRS OR THE REPLACEMENT OF THE PARTS ARE THE EXCLUSIVE REMEDIES UNDER THIS WARRANTY OR ANY IMPLIED WARRANTY. TOYOTA DOES NOT AUTHORIZE ANY PERSON TO CREATE FOR IT ANY OTHER OBLIGATION OR LIABILITY IN CONNECTION WITH TOYOTA PARTS OR ACCESSORIES.
- This warranty gives you specific legal rights, and you may also have other rights which vary from state to state.

OWNER'S RESPONSIBILITIES:

- To obtain this warranty coverage, return the part or accessory, or vehicle to which it is attached, to any authorized TOYOTA DEALER.
- Because warranty coverage periods are calculated on a time or mileage basis from the date of purchase, it is recommended that you retain proof of the purchase date and vehicle mileage at the time of purchase.

FOR MORE INFORMATION:

- For more information, please call your dealership or call TOYOTA toll-free at 1-800-331-4331.
- If you would prefer to write, our address is:
TOYOTA Customer Assistance Center
P.O. Box 2991, Torrance, CA 90500-2991

STATEMENT CONCERNING AMENDMENTS TO THE SONG-BEVERLY WARRANTY ACT AS FOLLOWS:

"A buyer of this product in California has the right to have this product serviced or repaired during the warranty period. The warranty period will be extended for the number of whole days that the product has been out of the buyer's hands for warranty repairs. If a defect exists within the warranty period, the warranty will not expire until the defect has been fixed. The warranty period will also be extended if the warranty repairs have not been performed due to delays caused by circumstances beyond the control of the buyer, or if the warranty repairs did not remedy the defect and the buyer notifies the manufacturer or seller of the failure of the repairs within 60 days after they were completed. If, after a reasonable number of attempts, the defect has not been fixed, the buyer may return this product for a replacement or a refund subject, in either case, to deduction of a reasonable charge for usage. This time extension does not affect the protections or remedies the buyer has under other laws."

LIEN FOR PAYMENT OF CHARGES: The undersigned customer and/or legal owner hereby grant to the dealer a lien upon, and security interest in, the vehicle described in this repair order to secure payment of all charges for repairs, including labor and parts, storage and towing, furnished under this repair order.

ALL PARTS AND SERVICE PROVIDED AS IS BY DEALERSHIP: ALL PARTS AND ACCESSORIES ARE SOLD AND ALL REPAIRS AND SERVICES ARE PROVIDED BY OUR DEALERSHIP AS IS. OUR DEALERSHIP DISCLAIMS ALL WARRANTIES, EXPRESS AND IMPLIED, INCLUDING THE IMPLIED WARRANTIES OF MERCHANTABILITY AND FITNESS FOR A PARTICULAR PURPOSE, IN CONNECTION WITH THE SALE OF PARTS AND ACCESSORIES AND/OR SERVICES AND REPAIRS PERFORMED BY OUR DEALERSHIP. THE ENTIRE RISK AS TO THE QUALITY AND PERFORMANCE OF THE VEHICLE AND PARTS AND ACCESSORIES IS WITH THE CUSTOMER AND, IF APPLICABLE, THE MANUFACTURER. IF THE VEHICLE OR ANY INSTALLED PARTS OR ACCESSORIES SHOULD PROVE DEFECTIVE FOLLOWING THEIR PURCHASE, THE CUSTOMER AND POSSIBLY THE MANUFACTURER AND NOT THE DEALERSHIP ASSUME THE ENTIRE COST OF ANY NECESSARY SERVICING OR REPAIR. CUSTOMER SHALL NOT BE ENTITLED TO RECOVER FROM THE DEALERSHIP ANY CONSEQUENTIAL DAMAGES, DAMAGES TO PROPERTY, DAMAGES FOR LOSS OF USE, LOSS OF TIME, LOSS OF PROFITS OR INCOME, OR ANY OTHER INCIDENTAL DAMAGES.

HAZARDOUS WASTE DISPOSAL COSTS: A charge may be assessed to cover costs associated with the handling, management and disposal of toxic waste or hazardous substances under California and Federal Law.

TO OUR SERVICE CUSTOMERS:

1. Our usual charges for labor are not based on actual mechanic's time, but are simply our prices for particular jobs.
2. You will be charged no more than the estimated price approved by you. However, if we discover that additional or actual repairs are indicated, you will be contacted for your advance approval of a revised estimate.
3. Customer is hereby notified that the said property is not insured or protected to the amount of the actual cash value thereof, or otherwise, against loss occasioned by theft, fire or vandalism while the property remains with the dealer.
4. Customer states no articles of personal property have been left in the vehicle and dealer is not responsible for inspection thereof.
5. The repair of this vehicle and completion date are subject to the availability of labor and parts. Dealer is not responsible for unavailability of parts or delays in parts shipment beyond Dealer's control.
6. Due to the type of service requested some repairs must be sublet.
7. All charges for repairs including labor and materials furnished are due and payable simultaneously with the delivery of the within described vehicle or prior to delivery upon the expiration of three (3) days after notice that repairs have been completed. Notice shall be deemed to have been given upon the deposit in the United States mail, postage prepaid, of written notification to that effect addressed to the customer at the address given on the front side hereof.
8. If the vehicle described herein is not called for within three (3) days after such notice is given, a daily storage fee will be charged.

9. Said Dealer is authorized to deliver the vehicle described herein or any of its contents to any person presenting this receipt.
10. In addition to any and all other legal remedies available, I authorize said Dealer to have a lien on the vehicle described herein for all charges, for repairs, including labor and parts, storage and/or towing, and to enforce such lien, said Dealer is hereby expressly authorized to sell said vehicle at public auction after giving a twenty (20) day written notice by certified mail to the legal owner, registered owner, and Department of Motor Vehicles of intent to do so. On the sale date, the vehicle shall be sold to the highest cash bidder and the proceeds of sale must be used first to satisfy the lien plus storage costs and costs incident to sale, and the balance shall be forwarded to the legal owner, or if none, to the registered owner, or if the address is unknown, it shall be forwarded to the Department of Motor Vehicles.
11. Said expenses for sale shall also include a reasonable attorney's fee, which may be necessarily.
12. If any such charges remain unpaid for thirty (30) days after such request for payment, said Dealer may also refer such charges to its attorneys for collection and the customer will pay a reasonable attorney's fee.
13. The Power-of-Attorney granted on the front of this Repair Order/Invoice shall be irrevocable and shall remain in effect for so long as there is an outstanding amount due under this Repair Order/Invoice.

State of California - Department of Consumer Affairs: NOTICE TO MOTORISTS:

If your vehicle fails Smog Check, federal law requires you to make necessary repairs to reduce your vehicle's emissions to required levels. If your vehicle is not under warranty and you have spent up to or more than the amount required by law for appropriate emissions-related repairs at a licensed Smog Check repair facility, you may be eligible for a one-time waiver. Repair waivers will NOT be issued for:
• Vehicles with missing, modified or disconnected emissions control equipment, regardless of the costs to make repairs;
• Vehicles identified as "Gross Polluters" - vehicles which have much higher emissions than properly maintained vehicles in their class;
• Vehicles that obtained a repair waiver after January 1, 1995, in their most recent biennial inspection or transfer of ownership.
Two consecutive repair waivers will not be issued after January 1, 1995.

If you obtain a smog certificate by means of fraud, you may be subject to a civil penalty of up to \$2500 per day of subject violation. Also, you may be subject to criminal prosecution. For further information, call the Department of Consumer Affairs toll-free at 1-800-952-6210.

BY LAW, YOU MAY CHOOSE ANOTHER LICENSED SMOG CHECK FACILITY TO PERFORM ANY NEEDED REPAIRS OR ADJUSTMENTS WHICH THE SMOG CHECK TEST INDICATES ARE NECESSARY.

*TOYOTA is Toyota Motor Sales, U.S.A., Inc. (a California corporation), for the purpose of warranty in the United States mainland.

WARNING

Motor vehicles contain chemicals known to the State of California to cause cancer and birth defects or other reproductive harm. These chemicals are contained in many vehicle components and replacement parts, vehicle fluids, and paints and materials used to maintain vehicles, including, but not limited to, fuel, oil, batteries, brakes, and wheel balancing weights. When you service, clean or maintain your car, you will be exposed to listed chemicals contained in used oil, waste and replacement fluids, fumes, grease, grime, touch-up paint, certain replacement parts, and particulates from component wear. When we service your car, we will return used components to you upon request. Used parts and components contain chemicals known to the State of California to cause cancer and birth defects or other reproductive harm.

To minimize your exposure when servicing, maintaining or cleaning your vehicle: 1) work in a well ventilated area; 2) do not smoke, drink or eat while working; 3) wash your hands when finished or when taking a break; and 4) follow all manufacturer instructions pertaining to proper use and maintenance of motor vehicles and vehicle components.

(Posted in accordance with Proposition 65 in Cal. Health & Safety Code §25249.5 et seq)

CUSTOMER #

AutoNation

AutoNation Toyota Cerritos
AutoNation Scion Cerritos

INVOICE

Cerritos Auto Square
18700 Studebaker Rd. + Cerritos, CA 90703-6375
Phone: (562) 402-2783
Fax: (562) 484-6369

PAGE 1

DOWNNEY, CA
HOME:
BUS:

SERVICE ADVISOR: 9547 ROBERTO FRATRE

COLOR	YEAR	MAKE/MODEL	VIN	LICENSE	MILEAGE IN/OUT	TAG
STERLING G	13	FORD EXPLORER	1FM5K7D84DC		16550/16551	

DEL. DATE	PROD. DATE	WARR. EXP.	PROMISED	PO NO.	RATE	PAYMENT	INV. DATE
15JUN13 DE			17:00 28JUN14			CASH	28JUN14

R.O. OPENED	READY	OPTIONS:	SOLD-STK	DLR:30956
12:58 28JUN14	15:39 28JUN14	ENG:3.5L_V6_Cyl		

LINE	OPCODE	TECH	TYPE	HOURS	LIST	NET	TOTAL
------	--------	------	------	-------	------	-----	-------

A Perform VCP Lube, Oil, Filter, and Tire Rotation
 VCPTR Perform VCP Lube, Oil, Filter, and Tire Rotation
 9741 ITXV (N/C)
 1 PLB10575 OIL FILTER (N/C)
 5 OIL OIL-G.O.G (N/C)

PARTS: 0.00 LABOR: 0.00 OTHER: 0.00 TOTAL LINE A: 0.00

16550 PERFORMED 4 WHEEL TIRE ROTATION SERVICE. INSPECTED REMAINING FRONT AND REAR BRAKES FOR REMAINING LIFE AND ADJUSTED TIRE PRESSURES TO FACTORY RECOMMENDED SPECIFICATIONS. PERFORMED ENGINE OIL REPLACEMENT SERVICE AND INSTALLED NEW GENUINE O.E.M. ENGINE OIL FILTER. PERFORMED MULTI-POINT INSPECTION SERVICE AND TOPPED OFF FLUIDS AS APPLICABLE.

B Customer requested to have Multi Point Inspection performed this visit

MULTI-A Customer requested to have Multi Point Inspection performed this visit

9741 CT 0.00 0.00

GTIRE GREEN-TIRE Inspected tires and Okay 9741 CT 0.00 0.00

GBATT BATTERY PASS 9741 CT 0.00 0.00

GBK BRAKES-GREEN Inspected brakes and okay. Please see your Advisor on your next visit. 9741 CT 0.00 0.00

PARTS: 0.00 LABOR: 0.00 OTHER: 0.00 TOTAL LINE B: 0.00

16550 FRONT BRAKES AT 9MM, REAR BRAKES AT 9MM
 LF32RF32RR32LR32

C Customer states perform courtesy car wash. WASH Customer states perform courtesy car wash. 9741 CT 0.00 0.00

PARTS: 0.00 LABOR: 0.00 OTHER: 0.00 TOTAL LINE C: 0.00

NO CLAIMS WITHOUT THIS INVOICE
 (**HAZARDOUS MATERIAL) THERE WILL BE A REMOVAL CHARGE FOR ALL HAZARDOUS MATERIALS REMOVED FROM YOUR AUTOMOBILE, THAT MUST BE DISPOSED OF AS A HAZARDOUS WASTE, SECTION 262.12 OF TITLE 40 OF CODE OF FED. REG.
 ALL PARTS INSTALLED ARE NEW UNLESS SPECIFIED OTHERWISE.

"By law, you may choose another licensed Smog Check facility to perform any needed repairs or adjustments that the Smog Check test indicates are necessary."

I ACKNOWLEDGE NOTICE AND ORAL APPROVAL OF AN INCREASE IN THE ORIGINAL ESTIMATED PRICE.

CUSTOMER SIGNATURE

REVISED ESTIMATE \$

SERVICE HOURS
 MONDAY - FRIDAY
 7:00 A.M. - 7:00 P.M.
 SATURDAY
 7:00 A.M. - 6:00 P.M.



PRESIDENT'S AWARD

DESCRIPTION	TOTALS
LABOR AMOUNT	
PARTS AMOUNT	
GAS, OIL, LUBE	
SUBLET AMOUNT	
MISC. CHARGES	
TOTAL CHARGES	
LESS INSURANCE	
SALES TAX	
PLEASE PAY THIS AMOUNT	

Notice to Consumer: Please read important information on back.
 CUSTOMER COPY

BAR # AK 055576 EPA # CAD 981379985

LIMITED WARRANTY FOR TOYOTA PARTS OR ACCESSORIES

TOYOTA warrants that it will direct provide a replacement part or repair any TOYOTA part or accessory that is defective in material or workmanship. This warranty applies to new or remanufactured parts which are genuine or authorized TOYOTA parts. Except for those parts or accessories listed below, warranty coverage is for 12 months, regardless of mileage. If the part or accessory is installed during the New Vehicle Limited Warranty period, coverage is for the 12 months or the remainder of the applicable warranty coverage.

TOYOTA authorized replacement parts are warranted from the date of purchase or installation for 24 months, regardless of mileage, or the remainder of any applicable new vehicle warranty, whichever occurs first, subject to certain conditions. The prorated amount based on MSRP, equivalent to the remaining warranty up to 24 months, will be credited toward the cost of a comparable Toyota replacement part, excluding taxes and labor for installation.

This warranty is provided independently of the Toyota manufacturer's warranty for complete vehicles.

- Damage to the TOYOTA part or accessory caused by a non-genuine or unauthorized TOYOTA part or component is not covered.
- Labor for removal from vehicle and reinstallation of a part or accessory sold "over-the-counter" is not covered.
- Labor, parts, and other costs (such as oil lubricants) connected with recommended maintenance programs are not covered. Service equipment, special calibration or adjustments, drive assist or Federal or state or local testing from computer installation, removal, repair, misuse, negligence, accidents, or modification of the part or the accessory are not covered.
- The Limited Warranty does not apply where the vehicle mileage cannot be determined or has been altered, or where proof of purchase is unavailable.

- INCIDENTAL OR CONSEQUENTIAL DAMAGES (FOR OTHER THAN PERSONAL INJURY) RESULTING FROM BREACH OF THIS WRITTEN WARRANTY OR ANY IMPLIED WARRANTY (SUCH AS TELEPHONE CALLS, LOSS OF TIME, INCONVENIENCE, OR COMMERCIAL LOSS) ARE NOT COVERED.
- ANY IMPLIED WARRANTIES, INCLUDING THOSE OF MERCHANTABILITY OR FITNESS FOR A PARTICULAR PURPOSE, ARE LIMITED TO THE APPLICABLE DURATION OF THIS WRITTEN WARRANTY. SOME STATES DO NOT ALLOW LIMITATION ON HOW LONG AN IMPLIED WARRANTY LASTS, OR THE EXCLUSION OR LIMITATION OF INCIDENTAL OR CONSEQUENTIAL DAMAGES, SO THE ABOVE LIMITATIONS OR EXCLUSIONS MAY NOT APPLY TO YOU.
- THIS IS THE ONLY EXPRESS WARRANTY AUTHORIZED BY TOYOTA. THE PERFORMANCE OF REPAIRS OR THE REPLACEMENT OF THE PARTS ARE THE EXCLUSIVE REMEDIES UNDER THIS WARRANTY OR ANY IMPLIED WARRANTY. TOYOTA DOES NOT AUTHORIZE ANY PERSON TO CREATE FOR IT ANY OTHER OBLIGATION OR LIABILITY IN CONNECTION WITH TOYOTA PARTS OR ACCESSORIES.
- This warranty does not affect your legal rights, and you may also have other rights which vary from state to state.

HOW TO OBTAIN WARRANTY

- To obtain this warranty coverage, return the part or accessory, or vehicle to which it is attached to any authorized TOYOTA DEALER.
- Because warranty coverage periods are calculated on a time or mileage basis from the date of purchase, it is recommended that you retain proof of the purchase date and vehicle mileage at the time of purchase.

FOR MORE INFORMATION

- For more information, please call your dealership or call TOYOTA toll-free at 1-800-331-4331.
- If you would prefer to write, our address is:
TOYOTA Customer Assistance Center
201 Box 2991, Torrance, CA 90501-2991

STATEMENT CONCERNING AMENDMENTS TO THE SONG-BEVERLY WARRANTY ACT AS FOLLOWS:

"A buyer of this product in California has the right to have this product serviced or repaired during the warranty period. The warranty period will be extended for the number of whole days that the product has been out of the buyer's hands for warranty repairs. If a defect exists within the warranty period, the warranty will not expire until the defect has been fixed. The warranty period will also be extended if the warranty repairs have not been performed due to delays caused by circumstances beyond the control of the buyer, or if the warranty repairs did not remedy the defect and the buyer notifies the manufacturer or seller of the failure of the repairs within 60 days after they were completed. If, after a reasonable number of attempts, the defect has not been fixed, the buyer may return this product for a replacement or a refund subject, in either case, to deduction of a reasonable charge for usage. This time extension does not affect the protections or remedies the buyer has under other laws."

LIEN FOR PAYMENT OF CHARGES: The designed customer and legal owner hereby grants to the dealer a lien and security interest in the vehicle described in this repair order to secure payment of charges for repairs including labor and parts, material and towing, for which dealer is not responsible.

ALL PARTS AND SERVICE PROVIDED AS IS BY DEALERSHIP: ALL PARTS AND ACCESSORIES ARE SOLD AND ALL REPAIRS AND SERVICES ARE PROVIDED BY OUR DEALERSHIP AS IS. OUR DEALERSHIP DISCLAIMS ALL WARRANTIES, EXPRESS AND IMPLIED, INCLUDING THE IMPLIED WARRANTIES OF MERCHANTABILITY AND FITNESS FOR A PARTICULAR PURPOSE, IN CONNECTION WITH THE SALE OF PARTS AND ACCESSORIES AND/OR SERVICES AND REPAIRS PERFORMED BY OUR DEALERSHIP. THE ENTIRE RISK AS TO THE QUALITY AND PERFORMANCE OF THE VEHICLE AND PARTS AND ACCESSORIES IS WITH THE CUSTOMER AND, IF APPLICABLE, THE MANUFACTURER. IF THE VEHICLE OR ANY INSTALLED PARTS OR ACCESSORIES SHOULD PROVE DEFECTIVE FOLLOWING THEIR PURCHASE, THE CUSTOMER AND POSSIBLY THE MANUFACTURER AND NOT THE DEALERSHIP ASSUME THE ENTIRE COST OF ANY NECESSARY SERVICING OR REPAIR. CUSTOMER SHALL NOT BE ENTITLED TO RECOVER FROM THE DEALERSHIP ANY CONSEQUENTIAL DAMAGES, DAMAGES TO PROPERTY, DAMAGES FOR LOSS OF USE, LOSS OF TIME, LOSS OF PROFITS OR INCOME, OR ANY OTHER INCIDENTAL DAMAGES.

HAZARDOUS WASTE DISPOSAL COSTS: A charge may be assessed to cover costs associated with the handling, management and disposal of toxic waste or hazardous substances under California and Federal Law.

TO OUR SERVICE CUSTOMERS:

1. Our Dealership is a customer service center. We are not a repair shop. We do not have a shop floor or a shop floor mechanic.
2. You will receive a repair order for the repair you request. We will not perform any repair unless you have a repair order. We will not perform any repair unless you have a repair order. We will not perform any repair unless you have a repair order.
3. Customer is hereby notified that the vehicle and any of its contents are returned to the customer at the risk of the customer. The vehicle and any of its contents are returned to the customer at the risk of the customer. The vehicle and any of its contents are returned to the customer at the risk of the customer.
4. Customer states no claims or charges have been filed in the area of and cover a not responsible for any such claims.
5. The repair of the vehicle and completion date are subject to the availability of parts and parts. The Dealership is not responsible for unavailability of parts or delays in parts shipment beyond the Dealership's control.
6. Due to the type of service requested, some repairs may be made.
7. All parts and materials are sold as is. Each access dealer agrees to their own terms and conditions. Notice is given under PAYMENT TERMS on the front and back will be returned to you upon receipt of your deposit on the front and back, postage prepaid. It is your responsibility to check all charges to the customer at the address shown on the front side of the order.
8. If the vehicle described herein is not repaired or repaired for 30 days after the date of repair, it may be sold as is and the charge.
9. The Dealership is not responsible for any damage to the vehicle caused by fire or theft or by any other cause not within the control of the Dealership.
10. In addition to any and all other legal remedies, we also warrant to the customer that we will repair the vehicle described herein for all charges for labor, material and parts, including labor and parts, subject to the terms and conditions set forth in this repair order. The Dealership is hereby authorized to sell as is, subject to the terms and conditions set forth in this repair order, any vehicle described herein. The vehicle will be sold to the highest bidder and the proceeds of sale shall be used for the benefit of the vehicle described herein and shall be subject to the terms and conditions set forth in this repair order. The vehicle will be sold to the highest bidder and the proceeds of sale shall be used for the benefit of the vehicle described herein. The vehicle will be sold to the highest bidder and the proceeds of sale shall be used for the benefit of the vehicle described herein.
11. Any such charges remain unpaid to many (30) days after such request for payment. The Dealership may and will sue such charges to its attorneys for collection and the customer will pay a reasonable attorney's fees.
12. The Dealer hereby grants on the most of this Repair Order to be used for the benefit of the vehicle described herein for all charges for labor, material and parts, including labor and parts, subject to the terms and conditions set forth in this repair order. The Dealer hereby grants on the most of this Repair Order to be used for the benefit of the vehicle described herein for all charges for labor, material and parts, including labor and parts, subject to the terms and conditions set forth in this repair order.
13. Remanufactured and refurbished parts may meet manufacturer approval so long as they are installed at our discretion. Additional information is available upon request.
14. The removal of an engine used as needed to locate vehicle repair, as well as any other data with the vehicle manufacturer for diagnostic and research purposes.

State of California - Department of Consumer Affairs: NOTICE TO MOTORISTS:

If your vehicle fails Smog Check, a repair order requires you to make necessary repairs to reduce your vehicle's emissions to required levels. If your vehicle is not under warranty and you have spent up to or more than the amount required by law for appropriate emission-related repairs at a licensed Smog Check repair facility, you may be eligible for a one-time waiver. Repair waivers will NOT be issued for:

- Vehicles with missing, modified or disconnected emissions control equipment, regardless of the cost to make repairs;
- Vehicles identified as "Gross Polluters" - vehicles which have much higher emissions than properly maintained vehicles in their class;
- Vehicles that obtained a repair waiver after January 1, 1995 - in their most recent annual inspection or transfer of ownership;
- Two consecutive repair waivers will not be issued after January 1, 1995.

For more information on this one-time waiver, call your local Smog Check station or call the Department of Consumer Affairs toll-free at 1-800-952-9076.

BY LAW, YOU MAY CHOOSE ANOTHER LICENSED SMOG CHECK FACILITY TO PERFORM ANY NEEDED REPAIRS OR ADJUSTMENTS WHICH THE SMOG CHECK TEST INDICATES ARE NECESSARY.

TOYOTA is Toyota Motor Sales, U.S.A., Inc. (a California corporation), as the purveyor of warranty in this United States mainland.

WARNING

Motor vehicles contain chemicals known to the State of California to cause cancer and birth defects or other reproductive harm. These chemicals are contained in many vehicle components and replacement parts, vehicle fluids, and paints and materials used to maintain vehicles, including, but not limited to, fuel, oil, batteries, brakes, and wheel balancing weights. When you service, clean or maintain your car, you will be exposed to listed chemicals contained in used oil, waste and replacement fluids, fumes, grease, grime, touch-up paint, certain replacement parts, and particulates from component wear. When we service your car, we will return used components to you upon request. Used parts and components contain chemicals known to the State of California to cause cancer and birth defects or other reproductive harm.

To minimize your exposure when servicing, maintaining or cleaning your vehicle: 1) work in a well ventilated area; 2) do not smoke, drink or eat while working; 3) wash your hands when finished or when taking a break; and 4) follow all manufacturer instructions pertaining to proper use and maintenance of motor vehicles and vehicle components.

(Printed in accordance with Proposition 65 in Cal. Health & Safety Code §25249.5 et seq.)

CUSTOMER #:

AutoNation

AutoNation Toyota Cerritos
AutoNation Scion Cerritos

INVOICE

Cerritos Auto Square
 18700 Studebaker Rd. · Cerritos, CA 90703-6375
 Phone: (562) 402-2783
 Fax: (562) 484-6369

DOWNEY, CA

PAGE 2

HOME:

BUS:

SERVICE ADVISOR: 9547 ROBERTO FRAIRE

CO	YEAR/MAKE/MODEL	VIN	LICENSE	MILEAGE IN / OUT
STERLING G 13	FORD EXPLORER	1FM5K7D84DC		16550/1655
DEL. DATE	PROD. DATE	WARR. EXP.	PROMISED	PO
15JUN13 DD			17:00 28JUN14	
R.O. OPENED	READY	OPTIONS:	SOLD-STK:	DLR: 30956
12:58 28JUN14	15:39 28JUN14	ENG:3.5L_V6_Cyl	TRN:A	
LINE	OPCODE	TECH	TYPE	HOURS
EST: 28.00				28JUN14 12:58 SA: 9547
			LIST	NET
				TOTAL

NO CLAIMS WITHOUT THIS INVOICE
 (**HAZARDOUS MATERIAL) THERE WILL BE A REMOVAL CHARGE FOR ALL HAZARDOUS MATERIALS REMOVED FROM YOUR AUTOMOBILE, THAT MUST BE DISPOSED OF AS A HAZARDOUS WASTE. SECTION 262.12 OF TITLE 40 OF CODE OF FED. REG.
 ALL PARTS INSTALLED ARE NEW UNLESS SPECIFIED OTHERWISE.
 By law, you may choose another licensed Smog Check facility to perform any needed repairs or adjustments that the Smog Check test indicates are necessary.
 I ACKNOWLEDGE NOTICE AND ORAL APPROVAL OF AN INCREASE IN THE ORIGINAL ESTIMATED PRICE.

SERVICE HOURS
 MONDAY - FRIDAY
 7:00 A.M. - 7:00 P.M.
 SATURDAY
 7:00 A.M. - 6:00 P.M.



PRESIDENT'S AWARD

DESCRIPTION	TOTALS
LABOR AMOUNT	0.00
PARTS AMOUNT	0.00
GAS, OIL, LUBE	0.00
SUBLET AMOUNT	0.00
MISC. CHARGES	0.00
TOTAL CHARGES	0.00
LESS INSURANCE	0.00
SALES TAX	0.00
PLEASE PAY THIS AMOUNT	0.00

CUSTOMER SIGNATURE _____
 REVISED ESTIMATE \$ _____

LIMITED WARRANTY FOR TOYOTA PARTS OR ACCESSORIES

TOYOTA warrants that it will either provide a replacement part or repair any TOYOTA part or accessory that is defective in material or workmanship. This warranty applies to new or remanufactured parts which are genuine or authorized TOYOTA parts. Except for these parts or accessories listed below, warranty coverage is for 12 months or 120,000 miles, whichever comes first. If the part or accessory is installed during the New Vehicle Limited Warranty period, coverage is for the 12 months or the remainder of the applicable warranty coverage.

TOYOTA authorized replacement parts are warranted from the date of purchase or installation for 24 months, regardless of mileage, or the remainder of any applicable new vehicle warranty, whichever provides greater protection, and on a prorated basis as a percentage. The prorated amount is based on the prorated new vehicle warranty up to 24 months, and will be credited toward the cost of a comparable Toyota replacement part, excluding labor and local taxes.

WHAT IS NOT COVERED BY THIS WARRANTY:

- Taxes are excluded independently by the local jurisdiction. See manufacturer's literature for details.
- Damage to the TOYOTA part or accessory caused by a fire, flood, or unauthorized TOYOTA part or component is not covered.
- Parts for removal from wrecks and installation of a part of accessory sold "over the-counter" is not covered.
- Labor parts and other items such as all electrical connected with recommended maintenance service are not covered. Service operations such as oil change or oil filter change, and tire services, failures or changes resulting from improper installation, removal, repair, misuse, negligence, accidents, or modification of the part or the accessory are not covered.
- This Limited Warranty does not apply where the vehicle mileage cannot be determined or has been tampered with or the part or accessory is unobtainable.

- INCIDENTAL OR CONSEQUENTIAL DAMAGES (FOR OTHER THAN PERSONAL INJURY) RESULTING FROM BREACH OF THIS WRITTEN WARRANTY OR ANY IMPLIED WARRANTY, SUCH AS TELEPHONE CALLS, LOSS OF TIME, INCONVENIENCE, OR COMMERCIAL LOSS, ARE NOT COVERED.
- ANY IMPLIED WARRANTIES, INCLUDING THOSE OF MERCHANTABILITY OR FITNESS FOR A PARTICULAR PURPOSE, ARE LIMITED TO THE APPLICABLE DURATION OF THIS WRITTEN WARRANTY. SOME STATES DO NOT ALLOW LIMITATION ON HOW LONG AN IMPLIED WARRANTY LASTS, OR THE EXCLUSION OR LIMITATION OF INCIDENTAL OR CONSEQUENTIAL DAMAGES, SO THE ABOVE LIMITATIONS OR EXCLUSIONS MAY NOT APPLY TO YOU.
- THIS IS THE ONLY EXPRESS WARRANTY AUTHORIZED BY TOYOTA. THE PERFORMANCE OF REPAIRS OR THE REPLACEMENT OF THE PARTS ARE THE EXCLUSIVE REMEDIES UNDER THIS WARRANTY OR ANY IMPLIED WARRANTY. TOYOTA DOES NOT AUTHORIZE ANY PERSON TO CREATE FOR IT ANY OTHER OBLIGATION OR LIABILITY IN CONNECTION WITH TOYOTA PARTS OR ACCESSORIES.
- This warranty gives you specific legal rights, and you may also have other rights which vary from state to state.

HOW TO OBTAIN THIS WARRANTY:

- To obtain this warranty coverage, retain the part or accessory, or vehicle to which it is attached to any authorized TOYOTA DEALER.
- Because warranty coverage periods are calculated on a time or mileage basis from the date of purchase, it is recommended that you retain proof of the purchase date and vehicle mileage at the time of purchase.

FOR MORE INFORMATION:

- For more information, please call your dealer or call TOYOTA toll-free at 1-800-331-8831.
- If you would prefer to write, our address is:
TOYOTA Customer Assistance Center
P.O. Box 2891, Torrance, CA 90509-2891

STATEMENT CONCERNING AMENDMENTS TO THE SONG-BEVERLY WARRANTY ACT AS FOLLOWS:

"A buyer of this product in California has the right to have this product serviced or repaired during the warranty period. The warranty period will be extended for the number of whole days that the product has been out of the buyer's hands for warranty repairs. If a defect exists within the warranty period, the warranty will not expire until the defect has been fixed. The warranty period will also be extended if the warranty repairs have not been performed due to delays caused by circumstances beyond the control of the buyer, or if the warranty repairs did not remedy the defect and the buyer notifies the manufacturer or seller of the failure of the repairs within 60 days after they were completed. If, after a reasonable number of attempts, the defect has not been fixed, the buyer may return this product for a replacement or a refund subject, in either case, to deduction of a reasonable charge for usage. This time extension does not affect the protections or remedies the buyer has under other laws."

USE FOR PAYMENT OF CHARGES: The limited, 24-month or 240,000-mile or 240,000-mile warranty period for the vehicle's repair and accessory coverage in the vehicle described in this repair order is void upon the sale of the vehicle to anyone, including the original purchaser, who is not a licensed dealer.

ALL PARTS AND SERVICE PROVIDED AS IS BY DEALERSHIP: ALL PARTS AND ACCESSORIES ARE SOLD AND ALL REPAIRS AND SERVICES ARE PROVIDED BY OUR DEALERSHIP AS IS. OUR DEALERSHIP DISCLAIMS ALL WARRANTIES, EXPRESS AND IMPLIED, INCLUDING THE IMPLIED WARRANTIES OF MERCHANTABILITY AND FITNESS FOR A PARTICULAR PURPOSE, IN CONNECTION WITH THE SALE OF PARTS AND ACCESSORIES AND/OR SERVICES AND REPAIRS PERFORMED BY OUR DEALERSHIP. THE ENTIRE RISK AS TO THE QUALITY AND PERFORMANCE OF THE VEHICLE AND PARTS AND ACCESSORIES IS WITH THE CUSTOMER AND, IF APPLICABLE, THE MANUFACTURER. IF THE VEHICLE OR ANY INSTALLED PARTS OR ACCESSORIES SHOULD PROVE DEFECTIVE FOLLOWING THEIR PURCHASE, THE CUSTOMER AND POSSIBLY THE MANUFACTURER, AND NOT THE DEALERSHIP ASSUME THE ENTIRE COST OF ANY NECESSARY SERVICE OR REPAIR. CUSTOMER SHALL NOT BE ENTITLED TO RECOVER FROM THE DEALERSHIP ANY CONSEQUENTIAL DAMAGES, DAMAGES TO PROPERTY, DAMAGES FOR LOSS OF USE, LOSS OF TIME, LOSS OF PROFITS OR INCOME, OR ANY OTHER INCIDENTAL DAMAGES.

HAZARDOUS WASTE DISPOSAL COSTS: A charge may be assessed to cover costs associated with the handling, management and disposal of toxic waste or hazardous substances under California and Federal Law.

TO OUR SERVICE CUSTOMERS:

- Our Dealership's usual charges for labor are not based on actual time spent on an assembly or repair for particular jobs.
- You will be charged for any extra diagnostic tests approved by your mechanic. The dealer will estimate the cost of such tests and you will be charged for any additional diagnostic tests as needed.
- Customer is hereby notified that the vehicle and any of its contents are not insured or protected by the amount of the dealer's cash value check or certificate, against loss caused by fire, theft or other causes while the property remains with the Dealership.
- Customer states no articles of personal property have been left in the vehicle and dealer is not responsible for inspection thereof.
- The repair of this vehicle and completion date are subject to the availability of parts and parts. The Dealership is not responsible for unavailability of parts or delays in parts shipment beyond the Dealership's control.
- Due to the type of service requested, some repairs may be billed.
- All labor and materials will be paid for in cash unless Dealer agrees to other payment arrangements in advance. Notice as stated under PAYMENT TERMS on the front side hereof will be deemed to have been given upon deposit in the United States mail, postage prepaid, of written notification to the effect addressed to the customer at the address given on the front side hereof.
- If the vehicle described herein is not driven for more than 30 days after each repair is given a daily storage fee will be charged.
- The Dealership is authorized to deliver the vehicle described herein to any of its contacts to any person presenting this order.
- In addition to any of all other fees currently available, I authorize the Dealership to have access to the vehicle described herein for all charges for repairs, including labor and parts, stored on the lot, towing, and to remove such lot. The Dealership is hereby expressly authorized to bill as a vehicle at such a stored lot giving a thirty (30) day written notice by certified mail to the legal owner, together with a copy of this order, for the full amount of the bill. The billable date, the vehicle will be sold at the repair cost factor and the position of sale must be stated first to satisfy the legal obligations and to provide the dealer with the balance and to be forwarded to the legal owner or owner, to the registered owner, or if the address is unknown, it shall be forwarded to the Department of Motor Vehicles. Said expense for sale shall also include a reasonable attorney's fees, which may be necessary in some cases.
- If any such charges remain unpaid for thirty (30) days after such request for payment, The Dealership may also refer such charges to its attorney for collection and the customer will pay a reasonable attorney's fee.
- The Power-of-Attorney granted on the front of this Repair Order/Invoice shall be irrevocable and shall remain in effect for as long as there is an outstanding amount due under this Repair Order/Invoice.
- Remanufactured and regulated parts that meet manufacturer approved routine part requirements may be installed at our discretion. Additional information is available upon request.
- I authorize the dealer or its agent to act as needed to initiate vehicle repair, or with an authorized dealer with the vehicle manufacturer for diagnostic and repair purposes.

State of California - Department of Consumer Affairs: NOTICE TO MOTORISTS:

If your vehicle fails Smog Check, Federal law requires you to make necessary repairs to reduce your vehicle's emissions to required levels. If your vehicle is not under warranty and you have spent up to or more than the amount required by law for appropriate emissions-related repairs at a licensed Smog Check repair facility, you may be eligible for a one-time waiver. Repair waivers will NOT be issued for:
Vehicles with missing, modified or disconnected emissions control equipment, regardless of the costs to make repairs;
Vehicles identified as "Gross Polluters" - vehicles which have much higher emissions than properly maintained vehicles in their class;
Vehicles that obtained a repair waiver after January 1, 1995, in their most recent biennial inspection or transfer of ownership;
Two consecutive repair waivers will not be issued after January 1, 1995.

You obtain a smog liability by resale without you may be subject to a civil penalty of up to \$2500 per day for each violation. Also, you may be subject to criminal prosecution. For full details, visit the Department of Consumer Affairs website at 1-800-952-5294.

BY LAW, YOU MAY CHOOSE ANOTHER LICENSED SMOG CHECK FACILITY TO PERFORM ANY NEEDED REPAIRS OR ADJUSTMENTS WHICH THE SMOG CHECK TEST INDICATES ARE NECESSARY.

*TOYOTA is Toyota Motor Sales, U.S.A., Inc. (a California corporation), for the purpose of warranty in the United States mainland.

WARNING

Motor vehicles contain chemicals known to the State of California to cause cancer and birth defects or other reproductive harm. These chemicals are contained in many vehicle components and replacement parts, vehicle fluids, and paints and materials used to maintain vehicles, including, but not limited to, fuel, oil, batteries, brakes, and wheel balancing weights. When you service, clean or maintain your car, you will be exposed to listed chemicals contained in used oil, waste and replacement fluids, fumes, grease, grime, touch-up paint, certain replacement parts, and particulates from component wear. When we service your car, we will return used components to you upon request. Used parts and components contain chemicals known to the State of California to cause cancer and birth defects or other reproductive harm.

To minimize your exposure when servicing, maintaining or cleaning your vehicle: 1) work in a well ventilated area; 2) do not smoke, drink or eat while working; 3) wash your hands when finished or when taking a break; and 4) follow all manufacturer instructions pertaining to proper use and maintenance of motor vehicles and vehicle components.

(Posted in accordance with Proposition 65 in Cal. Health & Safety Code §25249.5 et seq.)

AutoNation

AUTONATION TOYOTA BUENA PARK
AUTONATION SCION BUENA PARK

6400 BEACH BLVD.
BUENA PARK, CALIFORNIA 90621
TELEPHONE (714) 522-6144 (562) 802-1585
www.autonation.com

WORKORDER

PAGE 1

DOWNEY, CA

SERVICE ADVISOR: 9767 CAVANAUGH, AILEEN

COLOR	YEAR	MAKE/MODEL	VIN	LICENSE	MILEAGE IN/OUT	TAG	
STERLING G	13	FORD EXPLORER	1FM5K7D84DC		25934 /		
DEL DATE	PROD. DATE	WARR. EXP.	PROMISED	PO. NO.	RATE	PAYMENT	INV. D
15JUN13 DD			17:00 12FEB15			CASH	
R.O. OPENED	READY	OPTIONS:	SOLD-STK:DC	DLR:30956			
12FEB2015 12:07		ENG:3.5L_V6_Cyl	TRN:A				

LINE OF CODE	TECH...	TYPE	DESCRIPTIONS/INSTRUCTIONS
# A			CUSTOMER STATES THERE IS A NAIL IN ONE OF THE FRONT TIRES, PLEASE CHECK AN ADVIS E
01		CT	MAINTENANCE
# B			PLEASE PROVIDE MESSUREMENTS AND DOT ON RO
01		CT	MAINTENANCE
# C	MULTI-A	CT	PERFORM MULTIPOINT INSPECTION PER CUSTOMERS AUTHORIZATION



SERVICE DEPARTMENT HOURS
MONDAY-FRIDAY
7:00 AM - 7:00 PM
SATURDAY
8:00 AM - 6:00 PM

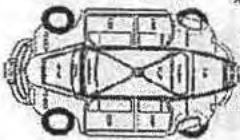

I hereby authorize the repair work to be done along with the necessary material, and hereby grant your employees permission to operate the vehicle herein described on streets, highways or elsewhere for the purpose of testing and/or inspections. Subject to conditions on reverse side of this contract. PLEASE READ REVERSE SIDE. COMPANY NOT RESPONSIBLE FOR LOSS OR DAMAGE DUE TO THEFT, FIRE OR VANDALISM.

CUSTOMER SIGNATURE
 OTHERWISE SPECIFIED
CUSTOMER ACKNOWLEDGES RECEIPT OF A COPY HEREOF. REBUILT PARTS
TERMS: STRICTLY CASH UNLESS ARRANGEMENTS MADE
QUALITY CHECK PARTS REMOVED WILL BE DISCARDED UNLESS OTHERWISE INSTRUCTED
 SAVE DISCARD

PRELIMINARY ESTIMATE \$ _____

Revised Estimate Parts. _____ Labor. _____ Total. \$ _____ Phone# _____
Date _____ Time _____ FAX# _____ BY _____
Revision Details _____ E-mail _____
In Person _____

Revised Estimate Parts. _____ Labor. _____ Total. \$ _____ Phone# _____
Date _____ Time _____ FAX# _____ BY _____
Revision Details _____ E-mail _____
In Person _____

I acknowledge notice an oral approval of an increase in the original estimated price.

(Signature or initials)

Notice to Consumer: Please read important information on back.

CUSTOMER COPY

LIMITED WARRANTY FOR TOYOTA PARTS OR ACCESSORIES

WHAT IS COVERED

TOYOTA* warrants that it will either provide a replacement part or repair any TOYOTA part or accessory that is defective in material or workmanship. This warranty applies to new or re-manufactured parts which are genuine or authorized TOYOTA parts. Except for those parts or accessories listed below, warranty coverage is for 12 months, regardless of mileage. If the part or accessory is installed during the New Vehicle Limited Warranty period, coverage is for the 12 months of the remainder of the applicable warranty coverage.

EXCLUDED WARRANTIES

TOYOTA authorized replacement batteries are warranted from the date of purchase or installation for 24 months, regardless of mileage, or the remainder of any applicable new vehicle warranty, whichever provides greater coverage, and on a pro-rata basis thereafter. The prorated amount (based on MSRP), equal to the remaining warranty up to 84 months, will be credited toward that of a comparable Toyota replacement battery, excluding taxes and labor for installation.

TERMS AND CONDITIONS

Terms are warranted independently by the true manufacturer. See manufacturer's statement for details.

WHAT IS NOT COVERED

- Damage to the TOYOTA part or accessory caused by a non-genuine or unauthorized TOYOTA part or component is not covered.
- Labor for removal from vehicle and reinstallation of a part or accessory with "over-the-counter" is not covered.
- Labor parts, and other costs such as all supplements, connected with, (except needed for maintenance service are not covered. Service adjustments, such as calibration of all components, are not covered.
- Failure or damage resulting from improper installation, removal, repair, misuse, negligent accident, or modification of the part or the accessory are not covered.
- This Limited Warranty does not apply where the vehicle mileage cannot be determined or has been altered, or where proof of purchase is unavailable.

INCIDENTAL OR CONSEQUENTIAL DAMAGES FOR OTHER THAN PERSONAL INJURY RESULTING FROM BREACH OF THIS WRITTEN WARRANTY OR ANY IMPLIED WARRANTY SUCH AS TELEPHONE CALLS, LOSS OF TIME, INCONVENIENCE OR COMMERCIAL LOSS ARE NOT COVERED.

ANY IMPLIED WARRANTIES INCLUDING THOSE OF MERCHANTABILITY OR FITNESS FOR A PARTICULAR PURPOSE ARE LIMITED TO THE APPLICABLE DURATION OF THIS WRITTEN WARRANTY. SOME STATES DO NOT ALLOW LIMITATION ON HOW LONG AN IMPLIED WARRANTY LASTS, OR THE EXCLUSION OR LIMITATION OF INCIDENTAL OR CONSEQUENTIAL DAMAGES, SO THE ABOVE LIMITATIONS OR EXCLUSIONS MAY NOT APPLY TO YOU.

THIS IS THE ONLY EXPRESS WARRANTY AUTHORIZED BY TOYOTA. THE PERFORMANCE OF REPAIRS OR THE REPLACEMENT OF THE PARTS ARE THE EXCLUSIVE REMEDIES UNDER THIS WARRANTY OR ANY IMPLIED WARRANTY. TOYOTA DOES NOT AUTHORIZE ANY PERSON TO CREATE FOR IT ANY OTHER OBLIGATION OR LIABILITY IN CONNECTION WITH TOYOTA PARTS OR ACCESSORIES.

This warranty does not affect your legal rights and you may also have other rights which vary from state to state.

TOYOTA CUSTOMER SERVICE CENTER

To obtain this warranty coverage, return the part or accessory, or vehicle to which it is attached, to the authorized TOYOTA DEALER.

Excluded warranty coverage periods will be stated on a time or mileage basis from the date of purchase, or is recommended that you obtain proof of the purchase date and vehicle mileage at the time of purchase.

FOR MORE INFORMATION

- For more information, please call your dealership or call TOYOTA toll free at 1-800-331-4331.
- If you would prefer to write, our address is:
TOYOTA Customer Assistance Center
P.O. Box 2831, Torrance, CA 90509-2831

STATEMENT CONCERNING AMENDMENTS TO THE SONG-BEVERLY WARRANTY ACT AS FOLLOWS:

"A buyer of this product in California has the right to have this product serviced or repaired during the warranty period. The warranty period will be extended for the number of whole days that the product has been out of the buyer's hands for warranty repairs. If a defect exists within the warranty period, the warranty will not expire until the defect has been fixed. The warranty period will also be extended if the warranty repairs have not been performed due to delays caused by circumstances beyond the control of the buyer, or if the warranty repairs did not remedy the defect and the buyer notifies the manufacturer or seller of the failure of the repairs within 80 days after they were completed. If, after a reasonable number of attempts, the defect has not been fixed, the buyer may return this product for a replacement or a refund subject, in either case, to deduction of a reasonable charge for usage. This time extension does not affect the protections or remedies the buyer has under other laws."

LIEN FOR PAYMENT OF CHARGES: The undersigned dealer and/or legal owner hereby grants to the repair shop upon, and security of, the vehicle described in this repair order to secure payment of all charges for repairs including labor and parts, storage and towing, authorized under this repair order.

ALL PARTS AND SERVICE PROVIDED AS IS BY DEALERSHIP. ALL PARTS AND ACCESSORIES ARE SOLD AND ALL REPAIRS AND SERVICES ARE PROVIDED BY OUR DEALERSHIP AS IS. OUR DEALERSHIP DISCLAIMS ALL WARRANTIES, EXPRESS AND IMPLIED, INCLUDING THE IMPLIED WARRANTIES OF MERCHANTABILITY AND FITNESS FOR A PARTICULAR PURPOSE, IN CONNECTION WITH THE SALE OF PARTS AND ACCESSORIES AND/OR SERVICES AND REPAIRS PERFORMED BY OUR DEALERSHIP. THE ENTIRE RISK AS TO THE QUALITY AND PERFORMANCE OF THE VEHICLE AND PARTS AND ACCESSORIES IS WITH THE CUSTOMER AND, IF APPLICABLE, THE MANUFACTURER. IF THE VEHICLE OR ANY INSTALLED PARTS OR ACCESSORIES SHOULD PROVE DEFECTIVE FOLLOWING THEIR PURCHASE, THE CUSTOMER AND POSSIBLY THE MANUFACTURER AND NOT THE DEALERSHIP ASSUME THE ENTIRE COST OF ANY NECESSARY SERVICING OR REPAIR. CUSTOMER SHALL NOT BE ENTITLED TO RECOVER FROM THE DEALERSHIP ANY CONSEQUENTIAL DAMAGES, DAMAGES TO PROPERTY, DAMAGES FOR LOSS OF USE, LOSS OF PROFITS OR INCOME, OR ANY OTHER INCIDENTAL DAMAGES.

HAZARDOUS WASTE DISPOSAL COSTS: A charge may be assessed to cover costs associated with the handling, management and disposal of toxic waste or hazardous substances under California and Federal Law.

TO OUR SERVICE CUSTOMERS:

1. Our Dealership's usual charges for labor are not based on fixed increments of time, but are simply our prices for particular jobs.
2. We will be charged no more than the called and approved price by you. However, we do reserve the right to charge for additional repairs as necessary, you will be contacted for your consent prior to a revised estimate.
3. Customer (i.e. you) notified that the vehicle and any of its contents are not insured or protected by the amount of the agreed cash value thereof, or otherwise, against loss occasioned by theft, fire or vandalism while the property remains with the Dealership.
4. Customer shall be notified if personal property has been left in the vehicle and dealer is not responsible for such property.
5. The repair of the vehicle and completion date are subject to the availability of labor and parts. The Dealership is not responsible for unavailability of parts or delays in parts shipment to your dealership.
6. Due to the type of service requested some repairs may be subject.
7. All labor and materials will be used for each unless dealer requests other pay method agreement in advance. Notices to send under PAYMENT TERMS on the front side of act will be required in full before work upon deposit in the United States may, postage prepaid, or within 10 business days of the date of the customer at the address given on the front side of act.
8. If the vehicle described herein is not called for within time (8) days after such materials given, a storage charge will be charged.
9. The Dealership is obligated to deliver the vehicle described hereon or any of its contents to you upon presenting this receipt.

10. In addition to any and all other legal remedies available, I authorize the Dealership to have a lien on the vehicle described herein for all charges for repairs, including labor, fuel, parts, storage, towing, law suit, and to enforce such lien. This Dealership is hereby expressly authorized to sell said vehicle at public auction after giving a thirty (30) day written notice by certified mail to the legal owner, registered owner, and Department of Motor Vehicles of intent to do so. On the sale date, the vehicle shall be sold to the highest cash bidder and the proceeds of sale must be used first to satisfy the lien plus storage dues and costs incident to sale, with the balance shall be forwarded to the legal owner, if it none, to the registered owner, or if the address is unknown, it shall be forwarded to the Department of Motor Vehicles. Said expenses for sale shall also include a reasonable attorney's fees, which may be necessary incurred.
11. If any such charges remain unpaid for thirty (30) days after such request for payment, the Dealership may also refer such charges to its attorney for collection and the customer will pay a reasonable attorney's fee.
12. The Product Warranty (printed on the back of this Repair Order) shall be irrevocable and shall remain in effect for so long as there is an outstanding amount due under the Repair Order invoice.
13. Remanufactured and rebuilt parts may, at our manufacturer approved source part requirements may be installed at the discretion. Additional preparation is provided upon request.
14. I authorize the removal of components as needed to facilitate vehicle repair, as well as sharing that data with the vehicle manufacturer for diagnostic and research purposes.

State of California - Department of Consumer Affairs: NOTICE TO MOTORISTS:

If your vehicle has Shrug Check, federal law requires you to make necessary repairs to reduce your vehicle's emissions to required levels. If your vehicle is not under warranty and you have spent up to or more than the amount required by law for appropriate emissions-related repairs at a licensed Shrug Check repair facility, you may be eligible for a one-time waiver. Repair waivers will NOT be issued for: Vehicles with missing, modified or disapproved emissions control equipment, regardless of the costs to make repairs; Vehicles identified as "Gross Polluters" - vehicles which have much higher emissions than properly maintained vehicles in their class; Vehicles that obtained a repair waiver after January 1, 1995, in their most recent biennial inspection or transfer of ownership. Two consecutive repair waivers will not be issued after January 1, 1995.

If you obtain a smog certificate by means of fraud, you may be subject to a civil penalty of up to \$2500 (30) day of subject violation. Also, you may be subject to criminal prosecution. For further information, call the Department of Consumer Affairs toll free at 1-800-527-3210.

BY LAW, YOU MAY CHOOSE ANOTHER LICENSED SMOG CHECK FACILITY TO PERFORM ANY NEEDED REPAIRS OR ADJUSTMENTS WHICH THE SMOG CHECK TEST INDICATES ARE NECESSARY.

*TOYOTA is Toyota Motor Sales, U.S.A., Inc. is a California corporation. For the purpose of warranty in the United States mainland.

WARNING

Motor vehicles contain chemicals known to the State of California to cause cancer and birth defects or other reproductive harm. These chemicals are contained in many vehicle components and replacement parts, vehicle fluids, and paints and materials used to maintain vehicles, including, but not limited to, fuel, oil, batteries, brakes, and wheel balancing weights. When you service, clean or maintain your car, you will be exposed to listed chemicals contained in used oil, waste and replacement fluids, fumes, grease, grime, touch-up paint, certain replacement parts, and particulates from component wear. When we service your car, we will return used components to you upon request. Used parts and components contain chemicals known to the State of California to cause cancer and birth defects or other reproductive harm.

To minimize your exposure when servicing, maintaining or cleaning your vehicle: 1) work in a well ventilated area; 2) do not smoke, drink or eat while working; 3) wash your hands when finished or when taking a break; and 4) follow all manufacturer instructions pertaining to proper use and maintenance of motor vehicles and vehicle components.

(Posted in accordance with Proposition 65 in Cal. Health & Safety Code §25349.5 et seq.)

CUSTOMER #:



AUTONATION TOYOTA BUENA PARK
AUTONATION SCION BUENA PARK

6400 BEACH BLVD.
BUENA PARK, CALIFORNIA 90621
TELEPHONE (714) 522-6144 (562) 802-1585
www.autonation.com

INVOICE

PAGE 1

DOWNEY, CA

HOMER
BUS:

SERVICE ADVISOR: 9767 AILEEN CAVANAUGH

CLERK	PLANT	MAKE/MODEL	VIN	LICENSE	MILEAGE IN / OUT	TAG	
		STERLING G 13 FORD EXPLORER	1FM5K7D84D		25934/25934		
DEL DATE	PROD DATE	WARR EXP	PROMISED	PO NO	RATE	PAYMENT	INV DATE
15JUN13 DD			17:00 12FEB15			CASH	12FEB15

H.O. OPENED	READY	OPTIONS:	SOLD-STK:DC	DLR:30956
12:07 12FEB15	12:49 12FEB15	ENG:3.5L_V6_Cyl	TRN:A	

LINE	OPCODE	TECH	TYPE	HOURS	LIST	NET	TOTAL
------	--------	------	------	-------	------	-----	-------

A CUSTOMER STATES THERE IS A NAIL IN ONE OF THE FRONT TIRES, PLEASE

CHECK AN ADVIS E

01 FOUND 1 NAIL IN EACH FRONT TIRE

7563 WIXM

(N/C)

2 TIRE PATCH TIRE-PATCH

(N/C)

01 REPAIR BOTH FRONT TIRES DUE TO NAILS

7563 WIXM

(N/C)

PARTS: 0.00 LABOR: 0.00 OTHER: 0.00 TOTAL LINE A: 0.00

B PLEASE PROVIDE MEASUREMENTS AND DOT ON RO

01 MAINTENANCE

7563 CT

0.00 0.00

PARTS: 0.00 LABOR: 0.00 OTHER: 0.00 TOTAL LINE B: 0.00

C PERFORM MULTIPOINT INSPECTION PER CUSTOMERS AUTHORIZATION

MULTI-D CUSTOMER DECLINED TO HAVE MULTI POINT

INSPECTION PERFORMED THIS VISIT

7563 CT

0.00 0.00

OTIRE TIRES GREEN, TIRES MEASURED ABOVE 6/32nds

PLEASE SEE YOUR SERVICE ADVISOR ON YOUR NEXT

VISIT

7563 CT

0.00 0.00

PARTS: 0.00 LABOR: 0.00 OTHER: 0.00 TOTAL LINE C: 0.00

Dealer is not authorized to perform recall repairs for non-Dealer brand vehicles and Dealer's vehicle safety and condition inspection and/or service does not include a review of possible pending recalls or service campaigns issued by manufacturers of other makes and models.

*By law, you may choose another licensed smog check facility to perform any needed repairs or adjustments which the Smog Check test indicates are necessary.

(**HAZARDOUS MATERIAL) THERE WILL BE A REMOVAL CHARGE FOR ALL HAZARDOUS MATERIALS REMOVED FROM YOUR AUTOMOBILE, THAT MUST BE DISPOSED OF AS A HAZARDOUS WASTE, SECTION 262.12 OF TITLE 46 OF CODE OF FED. REG.

THIS FORM IS AN ITEMIZED LIST OF REPAIRS AND IS PART OF A REPAIR ORDER. THIS REPAIR ORDER CONTINUATION IS SUBJECT TO ALL THE CONDITIONS OF THE ORIGINAL REPAIR ORDER.

CUSTOMER SIGNATURE

SERVICE HOURS

MONDAY-FRIDAY
7:00 AM - 7:00 PM

SATURDAY
8:00 AM - 5:00 PM

DESCRIPTION	TOTALS
LABOR AMOUNT	0.00
PARTS AMOUNT	0.00
GAS, OIL, LUBE	0.00
SUBLET AMOUNT	0.00
MISC. CHARGES	0.00
TOTAL CHARGES	0.00
LESS INSURANCE	0.00
SALES TAX	0.00
PLEASE PAY THIS AMOUNT	0.00

Notice to Consumer: Please read important information on back.
CUSTOMER COPY



R/C [Redacted] Customer Name [Redacted] ASM _____ /# _____

Mileage 25,934 Vehicle Description Explorer Tech _____ /# _____

	N/A	Checks O.K.	Needs Attention	Needs Immediate Attention		N/A	Checks O.K.	Needs Attention	Needs Immediate Attention	TIRE AND BRAKE INSPECTION:	
Operation of Lights & Inspect Lens					Battery & Cable Inspection					LF	RF
Condition of Wiper Inserts					Fluid Leaks					<input type="checkbox"/> Brake Lining ___ mm	<input type="checkbox"/> Brake Lining ___ mm
Condition of Suspension					Engine Oil					<input type="checkbox"/> Tire Tread ___ 32nds	<input type="checkbox"/> Tire Tread ___ 32nds
Condition of Drive Axles/Boots					Brake Fluid					<input type="checkbox"/> Wear Pattern _____	<input type="checkbox"/> Wear Pattern _____
AC & Heating Inspection					Transmission Fluid					<input type="checkbox"/> Tire Pressure ___ psi	<input type="checkbox"/> Tire Pressure ___ psi
Exhaust System Inspection					Differential Fluid					Lowest Brake Lining - mm: _____ BK_(2,3,4,5,6,8,10,12)	
Condition of Hoses					Power Steering Fluid					Lowest Tread Depth - 32nds: _____ TRT_(1,2,3,4,5,6,7,8,10,12)	
Condition of Drive Belts					Windshield Washer Fluid					Tires Dry Rot: <input type="checkbox"/> YES <input type="checkbox"/> NO	
Condition of Air Filter					Engine Coolant					LR	RR
Condition of Fuel System					Cabin Filter					<input type="checkbox"/> Brake Lining ___ mm	<input type="checkbox"/> Brake Lining ___ mm
										<input type="checkbox"/> Tire Tread ___ 32nds	<input type="checkbox"/> Tire Tread ___ 32nds
										<input type="checkbox"/> Wear Pattern _____	<input type="checkbox"/> Wear Pattern _____
										<input type="checkbox"/> Tire Pressure ___ psi	<input type="checkbox"/> Tire Pressure ___ psi

PRIMARY ITEM CONCERNS

Item, Description & Part Number	Total \$\$	SOP	Authorized	
Hankook 255/50/R20 104H			Y	N
DOT 5mYP PDL H 5212			Y	N
nails			Y	N
			Y	N
			Y	N
			Y	N

ADDITIONAL SERVICE RECOMMENDED

Safety	Drivability	Reliability	Item, Description & Part Number	Total \$\$	SOP	Authorized	
<input type="checkbox"/>	<input type="checkbox"/>	<input type="checkbox"/>				Y	N
<input type="checkbox"/>	<input type="checkbox"/>	<input type="checkbox"/>				Y	N
<input type="checkbox"/>	<input type="checkbox"/>	<input type="checkbox"/>				Y	N
<input type="checkbox"/>	<input type="checkbox"/>	<input type="checkbox"/>				Y	N
<input type="checkbox"/>	<input type="checkbox"/>	<input type="checkbox"/>				Y	N
<input type="checkbox"/>	<input type="checkbox"/>	<input type="checkbox"/>				Y	N
<input type="checkbox"/>	<input type="checkbox"/>	<input type="checkbox"/>				Y	N
<input type="checkbox"/>	<input type="checkbox"/>	<input type="checkbox"/>				Y	N
<input type="checkbox"/>	<input type="checkbox"/>	<input type="checkbox"/>	TOTALS			Y	N

Method of Customer Approval: _____ Time and Date of Approval: _____

The Vehicle Safety and Condition Inspection ("VSCI") is provided as a complimentary service to you and is limited in scope. There may be mechanical, equipment or system issues which were not detected by the VSCI. A complete vehicle diagnostic/inspection is available for an additional charge.

Est. Tax & Misc. _____

GRAND TOTAL: _____

CUSTOMER #

AutoNation

AutoNation Toyota Cerritos
AutoNation Scion Cerritos

INVOICE

Cerritos Auto Square
18700 Studebaker Rd., Cerritos, CA 90703-6375
Phone: (562) 402-2783
Fax: (562) 484-6369

DOWNEY, CA
HOME
BUS:

PAGE 1

SERVICE ADVISOR: 9097 BRYAN GODINEZ CRUZ

COLOR	YEAR	MAKE/MODEL	VIN	LICENSE	MILEAGE IN/OUT	TAG
STERLING G	13	FORD EXPLORER	1FM5K7D84DG		34572/34573	
DEL. DATE	PROD. DATE	WARR. EXP.	PROMISED	PO. NO.	RATE	PAYMENT
15JUN13 DD			12:45 05AUG15			CASH
R.O. OPENED	READY	OPTIONS: SOLD-STK:DC		DLR:30956		
11:26 05AUG15	13:41 05AUG15	ENG:3.5L_v6_cyl		TRN:A		

LINE	OPCODE	TECH	TYPE	HOURS	LIST	NET	TOTAL
------	--------	------	------	-------	------	-----	-------

A Multi Point Inspection included in Maintenance Service

CAUSE: none

MULTI-N Multi Point Inspection included in Maintenance Service

3362ITEPS

(N/C)

GBATT BATTERY PASS

3362ITEPS

(N/C)

GBK BRAKES-GREEN Inspected brakes and okay.

Please see your Advisor on your next visit.

3362ITEPS

(N/C)

GTIRE GREEN-TIRE Inspected tires and Okay

3362ITEPS

(N/C)

PARTS: 0.00 LABOR: 0.00 OTHER: 0.00 TOTAL LINE A: 0.00

34572 ALL TIRES ARE SET TO FACTORY SPECS FRONT LEFT AND RIGHT

38PSI, REAR LEFT AND RIGHT 38PSI.

B VACUUM - WIPE DASH AND CLEAN FRONT WINDOWS THANK YOU FOR PARTICIPATING IN TOYOTA'S NATION EFFORT TO CONSERVE WATER DURING THE DROUGHT

VAC VACUUM - WIPE DASH AND CLEAN FRONT WINDOWS

THANK YOU FOR PARTICIPATING IN TOYOTA'S NATION EFFORT TO CONSERVE WATER DURING THE DROUGHT

3362ITEPS

(N/C)

PARTS: 0.00 LABOR: 0.00 OTHER: 0.00 TOTAL LINE B: 0.00

C Perform VCP Lube, Oil, Filter, and Tire Rotation
VCPTR Perform VCP Lube, Oil, Filter, and Tire Rotation

3362 ITXV

(N/C)

1 PLB10575 OIL FILTER

(N/C)

6 00279-1QT20-01 B5 5W20 QTS W

(N/C)

PARTS: 0.00 LABOR: 0.00 OTHER: 0.00 TOTAL LINE C: 0.00

34572 PERFORMED ENGINE OIL REPLACEMENT SERVICE AND INSTALLED NEW

NO CLAIMS WITHOUT THIS INVOICE
(**HAZARDOUS MATERIAL) THERE WILL BE A REMOVAL CHARGE FOR ALL HAZARDOUS MATERIALS REMOVED FROM YOUR AUTOMOBILE, THAT MUST BE DISPOSED OF AS A HAZARDOUS WASTE, SECTION 262.12 OF TITLE 40 OF CODE OF FED. REG.

ALL PARTS INSTALLED ARE NEW UNLESS SPECIFIED OTHERWISE.

"By law, you may choose another licensed Smog Check facility to perform any needed repairs or adjustments that the Smog Check test indicates are necessary."

I ACKNOWLEDGE NOTICE AND ORAL APPROVAL OF AN INCREASE IN THE ORIGINAL ESTIMATED PRICE.

CUSTOMER SIGNATURE

REVISED ESTIMATE \$

SERVICE HOURS
MONDAY - FRIDAY
7:00 A.M. - 7:00 P.M.
SATURDAY
7:00 A.M. - 6:00 P.M.



PRESIDENT'S AWARD

DESCRIPTION	TOTALS
LABOR AMOUNT	
PARTS AMOUNT	
GAS, OIL, LUBE	
SUBLET AMOUNT	
MISC. CHARGES	
TOTAL CHARGES	
LESS INSURANCE	
SALES TAX	
PLEASE PAY THIS AMOUNT	

Notice to Consumer: Please read important information on back.

CUSTOMER COPY

BAR # AK 055576 EPA # CAD 981379985

LIMITED WARRANTY FOR TOYOTA PARTS OR ACCESSORIES

WHAT IS COVERED:

- TOYOTA warrants that it will install or provide replacement part or repair any TOYOTA part or accessory that is defective under this warranty. This warranty applies to new or remanufactured parts and accessories authorized TOYOTA parts. Except for those parts or accessories listed below, the warranty period is 12 months, regardless of mileage. If the part or accessory is listed below, the warranty period, coverage is for the 12 months of the limited warranty period, excluding taxes and labor for installation.

BATTERY LIMITED WARRANTY:

- TOYOTA authorized dealerships will be prorated from the date of purchase or installation for 24 months, regardless of mileage, or the remainder of any applicable new vehicle warranty, whichever provides the greater coverage, and prorated basis thereafter. The prorated amount (based on MSRP) will be credited to the customer up to 24 months, will be credited toward that of a comparable Toyota replacement car battery, excluding taxes and labor for installation.

TIRE LIMITED WARRANTY:

- Tires are warranted under the manufacturer's warranty. See manufacturer's statement for details.

WHAT IS NOT COVERED:

- Damages to the TOYOTA part or accessory caused by a non-genuine or unauthorized TOYOTA part or component.
- Labor for removal and installation of a part or accessory sold "over-the-counter" is not covered.
- Labor, parts, and other services (such as oil changes) connected with recommended maintenance service are not covered. Services such as calibration or alignments, are not covered.
- Failures or damages due to improper installation, removal, repair, misuse, negligence, accidents, or modification of the vehicle are not covered.
- This Limited Warranty does not cover any vehicle mileage cannot be determined or has been altered, or any part of the vehicle.

- INCIDENTAL OR CONSEQUENTIAL DAMAGES (FOR OTHER THAN PERSONAL INJURY) RESULTING FROM BREACH OF THIS WRITTEN WARRANTY OR ANY IMPLIED WARRANTY (SUCH AS TELEPHONE CALLS, LOSS OF TIME, INCONVENIENCE, OR COMMERCIAL LOSS) ARE NOT COVERED.

- ANY IMPLIED WARRANTIES, INCLUDING THOSE OF MERCHANTABILITY OR FITNESS FOR A PARTICULAR PURPOSE, ARE LIMITED TO THE APPLICABLE DURATION OF THIS WRITTEN WARRANTY. SOME STATES DO NOT ALLOW LIMITATION ON HOW LONG AN IMPLIED WARRANTY LASTS, OR THE EXCLUSION OR LIMITATION OF INCIDENTAL OR CONSEQUENTIAL DAMAGES, SO THE ABOVE LIMITATIONS OR EXCLUSIONS MAY NOT APPLY TO YOU.

- THIS IS THE ONLY EXPRESS WARRANTY AUTHORIZED BY TOYOTA. THE PERFORMANCE OF REPAIRS OR THE REPLACEMENT OF THE PARTS ARE THE EXCLUSIVE REMEDIES UNDER THIS WARRANTY OR ANY IMPLIED WARRANTY. TOYOTA DOES NOT AUTHORIZE ANY PERSON TO CREATE FOR IT ANY OTHER OBLIGATION OR LIABILITY IN CONNECTION WITH TOYOTA PARTS OR ACCESSORIES.

- This warranty gives you specific legal rights, and you may also have other rights which vary from state to state.

OWNER'S RESPONSIBILITIES:

- To obtain this warranty coverage, return the part or accessory, or vehicle to which it is attached, to any authorized TOYOTA DEALER.
- Because warranty coverage periods are calculated on a time or mileage basis from the date of purchase, it is recommended that you retain proof of the purchase date and vehicle mileage at the time of purchase.

FOR MORE INFORMATION:

- For more information, please call your dealership or call TOYOTA toll-free at 1-800-331-4331.
- If you would prefer to write, our address is:
TOYOTA Customer Assistance Center
P.O. Box 2991, Torrance, CA 90509-2991

STATEMENT OF GOVERNING AMENDMENTS TO THE SONG-BEVERLY WARRANTY ACT AS FOLLOWS:

"A buyer of this product in California has the right to have this product serviced or repaired during the warranty period. The warranty period will be extended for the number of whole days that the product has been out of the buyer's hands for warranty repairs. If a defect exists within the warranty period, the warranty will not expire until the defect has been fixed. The warranty period will also be extended if the warranty repairs have not been performed due to delays caused by circumstances beyond the control of the buyer, or if the warranty repairs did not remedy the defect and the buyer notifies the manufacturer or seller of the failure of the repairs within 60 days after they were completed. If, after a reasonable number of attempts, the defect has not been fixed, the buyer may return this product for a replacement or a refund subject, in either case, to deduction of a reasonable charge for usage. This time extension does not affect the protections or remedies the buyer has under other laws."

LIEN FOR PAYMENT: The customer hereby grants to the dealer a lien upon, and security interest in, the vehicle described in this repair order to secure payment of all charges for repairs, including labor and parts, and any other charges assessed under this repair order.

ALL PARTS AND SERVICE PARTS: ALL PARTS AND ACCESSORIES ARE SOLD AND ALL REPAIRS AND SERVICES ARE PROVIDED BY OUR DEALERSHIP AS IS. OUR DEALERSHIP DISCLAIMS ALL WARRANTIES, INCLUDING THE IMPLIED WARRANTIES OF MERCHANTABILITY AND FITNESS FOR A PARTICULAR PURPOSE, IN CONNECTION WITH THE SALE OF PARTS AND ACCESSORIES. ALL PARTS AND REPAIRS PERFORMED BY OUR DEALERSHIP, THE ENTIRE RISK AS TO THE QUALITY AND PERFORMANCE OF THE VEHICLE AND PARTS AND ACCESSORIES IS WITH THE BUYER. IF THE VEHICLE OR ANY INSTALLED PARTS OR ACCESSORIES SHOULD PROVE DEFECTIVE FOLLOWING THEIR PURCHASE, THE CUSTOMER SHALL ASSUME THE ENTIRE COST OF ANY NECESSARY SERVICING OR REPAIR. CUSTOMER SHALL NOT BE ENTITLED TO RECOVER INCIDENTAL OR CONSEQUENTIAL DAMAGES, DAMAGES TO PROPERTY, DAMAGES FOR LOSS OF USE, LOSS OF TIME, LOSS OF PROFITS OR INCOME, OR ANY OTHER INCIDENTAL DAMAGES.

HAZARDOUS WASTE: The customer may be assessed to cover costs associated with the handling, management and disposal of toxic waste or hazardous substances under California and Federal law.

TO OUR SERVICE CUSTOMERS:

- Our Dealership's estimate is based on actual mechanic's time, but are simply our prices for particular work.
- You will be charged for any additional work requested by you. However, the discover that different or additional repair is needed, we will advise you in advance approval of a revised estimate.
- Customer is hereby authorized to allow the Dealer to use any information contained or projected to the amount of the repair order, including but not limited to, any information received by the Dealer, or vandalism while the vehicle is in the shop, or any information received by the Dealer, or any information received by the Dealer, or any information received by the Dealer.
- Customer states that the vehicle is to be returned to the Dealer and Dealer is not responsible for any damage to the vehicle or its contents while in the shop.
- The repair of the vehicle is to be completed by the Dealer. The Dealer's estimate is based on actual mechanic's time and parts. The Dealer's estimate is based on actual mechanic's time and parts. The Dealer's estimate is based on actual mechanic's time and parts.
- Due to the type of work being performed, the vehicle may be left in the shop for a period of time.
- All labor and materials are provided by the Dealer. The Dealer agrees to other payment arrangements in advance. Notices of any other payment arrangements will be deemed to have been given upon the date of the repair order, or upon the date of written notification to that effect addressed to the Dealer at the address listed on the repair order.
- If the vehicle described in this repair order is to be repaired, a daily storage fee will be charged.
- The Dealership is authorized to deliver the vehicle described herein or any of its contents to any person presenting this repair order.
- In addition to any and all other legal remedies available, I authorize the Dealership to have a lien on the vehicle described herein for all charges for repairs, including labor and parts, storage and/or towing, and to enforce such lien. The Dealership is hereby expressly authorized to sell said vehicle at public auction after giving a twenty (20) day written notice by certified mail to the legal owner, registered owner, and Department of Motor Vehicles of intent to do so. On the sale date, the vehicle shall be sold to the highest cash bidder and the proceeds of sale must be used first to satisfy the lien plus storage costs and costs incident to sale, and the balance shall be forwarded to the legal owner, or if none, to the registered owner, or if the address is unknown, it shall be forwarded to the Department of Motor Vehicles. Said expenses for sale shall also include a reasonable attorney's fees, which may be necessarily incurred.
- If any such charges remain unpaid for thirty (30) days after such request for payment, The Dealership may also refer such charges to its attorneys for collection and the customer will pay a reasonable attorney's fee.
- The Power-of-Attorney granted on the front of this Repair Order/Invoice shall be irrevocable and shall remain in effect for so long as there is an outstanding amount due under this Repair Order/Invoice.
- Remanufactured and refurbished parts that meet manufacturer approved source part requirements may be installed at our discretion. Additional information is available upon request.
- I authorize the retrieval of on-board data as needed to facilitate vehicle repair, as well as sharing that data with the vehicle manufacturer for diagnostic and research purposes.

State of California - Department of Consumer Affairs: NOTICE TO MOTORISTS:

If your vehicle fails Smog Check, federal law requires you to make necessary repairs to reduce your vehicle's emissions to required levels. If your vehicle is not under warranty and you have spent up to or more than the amount required by law for appropriate emissions-related repairs at a licensed Smog Check repair facility, you may be eligible for a one-time waiver. Repair waivers will NOT be issued for:

- vehicles with missing, modified or disconnected emissions control equipment, regardless of the costs to make repairs;
- vehicles identified as "Gross Polluters" - vehicles which have much higher emissions than properly maintained vehicles in their class;
- vehicles that obtained a repair waiver after January 1, 1995, in their most recent biennial inspection or transfer of ownership.

Repetitive repair waivers will not be issued after January 1, 1995.

If you obtain a smog certificate by means of a repair waiver, you may be subject to a civil penalty of up to \$2500 per day of subject violation. Also, you may be subject to criminal prosecution. For further information, call the Department of Consumer Affairs toll-free at 1-800-652-5210.

BY LAW, YOU MAY CHOOSE ANOTHER LICENSED SMOG CHECK FACILITY TO PERFORM ANY NEEDED REPAIRS OR ADJUSTMENTS WHICH THE SMOG CHECK TEST INDICATES ARE NECESSARY.

*TOYOTA is Toyota Motor Sales, U.S.A., Inc. (a California corporation), for the purpose of warranty in the United States mainland.

WARNING

Motor vehicles contain chemicals known to the State of California to cause cancer and birth defects or other reproductive harm. These chemicals are contained in many vehicle components and replacement parts, vehicle fluids, and paints and materials used to maintain vehicles, including, but not limited to, fuel, oil, batteries, brakes, and wheel balancing weights. When you service, clean or maintain your car, you will be exposed to listed chemicals contained in used oil, waste and replacement fluids, fumes, grease, grime, touch-up paint, certain replacement parts, and particulates from component wear. When we service your car, we will return used components to you upon request. Used parts and components contain chemicals known to the State of California to cause cancer and birth defects or other reproductive harm.

To minimize your exposure when servicing, maintaining or cleaning your vehicle: 1) work in a well ventilated area; 2) do not smoke, drink or eat while working; 3) wash your hands when finished or when taking a break; and 4) follow all manufacturer instructions pertaining to proper use and maintenance of motor vehicles and vehicle components.

(Posted in accordance with Proposition 65 in Cal. Health & Safety Code §25249.5 et seq.)

CUSTOMER # [REDACTED]

AutoNation

AutoNation Toyota Cerritos
AutoNation Scion Cerritos

INVOICE

Cerritos Auto Square
18700 Studebaker Rd. Cerritos, CA 90703-6375
Phone: (562) 402-2783
Fax: (562) 484-6369

DOWNEY, CA

PAGE 2

HOME [REDACTED]

BUS: [REDACTED]

SERVICE ADVISOR: 9097 BRYAN GODINEZ CRUZ

COLOR	YEAR	MAKE/MODEL	VIN	LICENSE	MLEAGE IN/OUT	TAG	
STERLING G	13	FORD EXPLORER	1FM5K7D84DG [REDACTED]	[REDACTED]	34572/34573	[REDACTED]	
DEL. DATE	PROD. DATE	WARR. EXP.	PROMISED	PO NO.	RATE	PAYMENT	INV. DATE
15JUN13 DL			12:45 05AUG15			CASH	05AUG15

R.O. OPENED	READY	OPTIONS:	SOLD-STK:DG	DLR:30956
11:26 05AUG15	13:41 05AUG15	ENG:3.5L_V6_Cyl	TRN:A	

LINE	OPCODE	TECH	TYPE	HOURS	LIST	NET	TOTAL
ENGINE OIL AND FILTER, ADJUST TIRES TO SPEC. PERFORMED MULTI-POINT INSPECTION SERVICE AND TOPPED OFF FLUIDS AS APPLICABLE.							

EST: 28.00 05AUG15 11:26 SA: 9097

Dealer is not authorized to perform recall repairs for non-Dealer brand vehicles and Dealer's Vehicle Safety and Condition Inspection and/or service does not include a review of possible pending recalls or service campaigns issued by manufacturers of other makes and models.



NO CLAIMS WITHOUT THIS INVOICE
 (**HAZARDOUS MATERIAL) THERE WILL BE A REMOVAL CHARGE FOR ALL HAZARDOUS MATERIALS REMOVED FROM YOUR AUTOMOBILE, THAT MUST BE DISPOSED OF AS A HAZARDOUS WASTE. SECTION 262.12 OF TITLE 40 OF CODE OF FED. REG.
 ALL PARTS INSTALLED ARE NEW UNLESS SPECIFIED OTHERWISE.
 By law, you may choose another licensed Smog Check facility to perform any needed repairs or adjustments that the Smog Check test indicates are necessary.
 I ACKNOWLEDGE NOTICE AND ORAL APPROVAL OF AN INCREASE IN THE ORIGINAL ESTIMATED PRICE.

SERVICE HOURS
 MONDAY - FRIDAY
 7:00 A.M. - 7:00 P.M.
 SATURDAY
 7:00 A.M. - 6:00 P.M.



DESCRIPTION	TOTALS
LABOR AMOUNT	0.00
PARTS AMOUNT	0.00
GAS, OIL, LUBE	0.00
SUBLET AMOUNT	0.00
MISC. CHARGES	0.00
TOTAL CHARGES	0.00
LESS INSURANCE	0.00
SALES TAX	0.00
PLEASE PAY THIS AMOUNT	0.00

Notice to Consumer: Please read important information on back.
CUSTOMER COPY

BAR # AK 055576 EPA # CAD 981379985

CUSTOMER #

AutoNation

AutoNation Ford Tustin

#2 AUTO CENTER DR. TUSTIN, CA 92782
(714) 832-3300
www.autonation.com

INVOICE

PAGE 1

SERVICE ADVISOR: 2224 MARK CIESLA

COLOR	YEAR	MAKE/MODEL	VIN	LICENSE	MILEAGE IN/OUT	TAG
STERLING G	13	FORD EXPLORER	1FMSK7D84		39950/39950	
DEL. DATE	PROD. DATE	WARR. EXP.	PROMISED	PO NO.	RATE	PAYMENT
15JUN13 DD			WAIT 04NOV15			CASH
R.O. OPENED	READY	OPTIONS:	SOLD-STK:	DLR:30956		
10:37 04NOV15	11:30 04NOV15	ENG:3.5L_V6_Cyl	TRN:A			

LINE	OPCODE	TECH	TYPE	HOURS	LIST	NET	TOTAL
------	--------	------	------	-------	------	-----	-------

A Perform VCP Lube, Oil, Filter and Tire Rotation
 VCPTR Perform VCP Lube, Oil, Filter and Tire Rotation
 8966 IFXV (N/C)
 1 AA5Z*6714*B FILTER ASY - OIL (N/C)
 6 5W20QL OIL-ENGINE (N/C)
 1 OW EPA CHARGE (N/C)
 PARTS: 0.00 LABOR: 0.00 OTHER: 0.00 TOTAL LINE A: 0.00
 39950 8966 0.9 LOF AND ROTATE

B MULTI-POINT VEHICLE INSPECTION AUTHORIZED BY CUSTOMER, TIRE PRESSURE.
 READINGS: RF LF RR LR
 MULTI-A MULTI-POINT VEHICLE INSPECTION AUTHORIZED BY CUSTOMER, TIRE PRESSURE READINGS:
 RF LF RR LR
 8966IFEPS (N/C)
 GBATT BATTERY CHECKED AND OK AT THIS TIME (N/C)
 8966IFEPS (N/C)
 YTIRE MAY REQUIRE FUTURE ATTENTION TIRES AT 4/32-5/32 (N/C)
 8966IFEPS (N/C)
 GBK CHECKED BRAKES OK (N/C)
 8966IFEPS (N/C)
 DSAF Declined A/C Cabin Filter replacement (N/C)
 8966IFEPS (N/C)
 DSAIF Declined Engine Air Filter replacement (N/C)
 8966IFEPS (N/C)
 PARTS: 0.00 LABOR: 0.00 OTHER: 0.00 TOTAL LINE B: 0.00

B.A.R. #AG126349 E.P.A. #CA0000198214 "I acknowledge, notice and oral approval of an increase in the original estimated price." _____ (Signature or Initials) "By law you may choose another facility to perform any needed repairs or adjustments which the amog check text indicates are necessary."	ALL PARTS INSTALLED ARE NEW UNLESS SPECIFIED OTHERWISE. ALL NEW REPLACEMENT PARTS AND LABOR HAVE A LIMITED WARRANTY FOR 12,000 MILES OR 12 MONTHS, WHICHEVER COMES FIRST. PLEASE SEE IMPORTANT INFORMATION ON REVERSE SIDE.	STORE HOURS MON.-FRI. 7:00 A.M. TO 7:00 P.M. SATURDAY 7:00 A.M. TO 5:00 P.M.	DESCRIPTION	TOTALS
			LABOR AMOUNT	
			PARTS AMOUNT	
			GAS, OIL, LUBE	
			SUBLET AMOUNT	
			MISC. CHARGES	
			TOTAL CHARGES	
			LESS INSURANCE	
			SALES TAX	
			PLEASE PAY THIS AMOUNT	

X
CUSTOMER SIGNATURE

CUSTOMER COPY

CUSTOMER #

AutoNation

AutoNation Ford Tustin

#2 AUTO CENTER DR. • TUSTIN, CA 92782

(714) 832-3300

www.autonation.com

INVOICE

PAGE 2

DOWNEY, CA

HOME

BUS:

SERVICE ADVISOR: 2224 MARK CIESLA

COLOR	YEAR	MAKE/MODEL	VIN	LICENSE	MILEAGE IN/OUT	TAG	
STERLING G	13	FORD EXPLORER	1FM5K7D84DG		39950/39950		
DEL. DATE	PRD. DATE	WARR. EXP.	PROMISED	PO. NO.	RATE	PAYMENT	INV. DATE
15JUN13 DD			WAIT 04NOV15			CASH	04NOV15
R.O. OPENED	READY	OPTIONS:		SOLD-STK: DG		PIR 30956	
10:37 04NOV15	11:30 04NOV15	ENG:3.5L_V6_Cyl		TRN:A			
LINE	OPCODE	TECH	TYPE	HOURS	LIST	NET	TOTAL
EST: 47.39				04NOV15 10:37	SA: 2224		

Dealer is not authorized to perform recall repairs for non-Dealer brand vehicles and Dealer's Vehicle Safety and Condition Inspection and/or service does not include a review of possible pending recalls or service campaigns issued by manufacturers of other makes and models.

AutoNation

B.A.R. #AG126349 E.P.A. #CA0000195214 <small>"I acknowledge notice and oral approval of an increase in the original estimated price."</small> (signature or initials) <small>"By law you may choose another facility to perform any needed repairs or adjustments which the smog check test indicates are necessary."</small>	ALL PARTS INSTALLED ARE NEW UNLESS SPECIFIED OTHERWISE. ALL NEW REPLACEMENT PARTS AND LABOR HAVE A LIMITED WARRANTY FOR 12,000 MILES OR 12 MONTHS, WHICHEVER COMES FIRST.	STORE HOURS MON.-FRI. 7:00 A.M. TO 7:00 P.M. SATURDAY 7:00 A.M. TO 5:00 P.M.	DESCRIPTION	TOTALS
	PLEASE SEE IMPORTANT INFORMATION ON REVERSE SIDE.		LABOR AMOUNT	0.00
X CUSTOMER SIGNATURE			PARTS AMOUNT	0.00
			GAS, OIL, LUBE	0.00
			SUBLET AMOUNT	0.00
			MISC. CHARGES	0.00
			TOTAL CHARGES	0.00
			LESS INSURANCE	0.00
			SALES TAX	0.00
			PLEASE PAY THIS AMOUNT	0.00

David and Kristin Guerrero Sign out

Outlook.com

2680 Edit in Word Add to OneDrive Print Exit ...

CUSTOMER # [REDACTED]

[REDACTED] RO

DOWNNEY, CA
HOME [REDACTED]
BUS: [REDACTED]

COLOR	YEAR	MAK
STERLING G	13	FORD E3
DEL. DATE	PROD. DATE	WAR
15JUN13 DE		
R.D. OPENED		RE

10:37 04NOV15 11:30 C

LINE OPCODE TECH TYPE

A Perform VCP Lube, Oil

VCPTR Perform VCP

Rotation:

8966 IFXV

1 AA5Z*6714*B:

6 5W20QL OIL-E

1 OW BPA CHARG

PARTS: 0.00 LABC

39950 8966 0.9 LOP AN

B MULTI-POINT VEHICLE

READINGS: RF

MULTI-A MULTI-POI

BY CUSTOMER,

RF LF

8966IFEPS

GBATT BATTERY CHG

8966IFEPS

YTIRE MAY REQUIRE

4/32-5/32

8966IFEPS

GBK CHECKED BRAKE

8966IFEPS

DSAF Declined A/C

8966IFEPS

DSAIIF Declined En

8966IFEPS

PARTS: 0.00 LABO

HELP IMPROVE OFFICE 100%



TOE WEAR

"Feathered" tread wear pattern suggests that tires are turned in or out too far. Signals need for alignment. May be caused by worn shocks/struts.

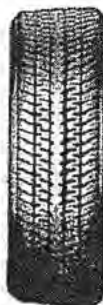

CAMBER WEAR

Exaggerated wear on inner or outer edge of tire indicates that tires are tilted in or out too far (from vertical). Signals need for alignment. May be caused by worn shocks/struts.

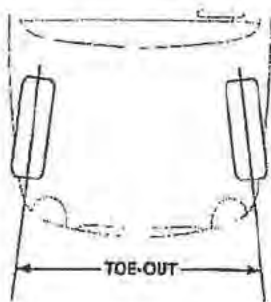
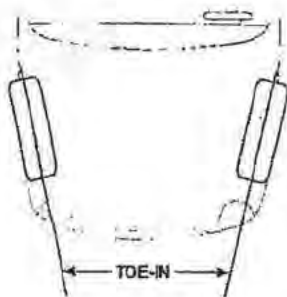

DISC BRAKE

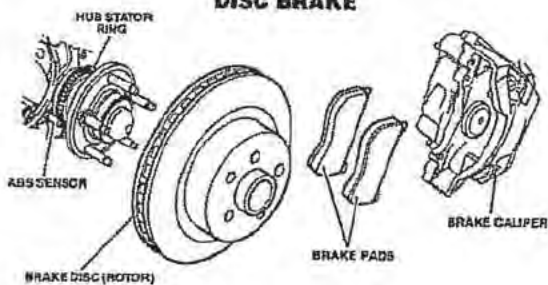

DRUM BRAKE

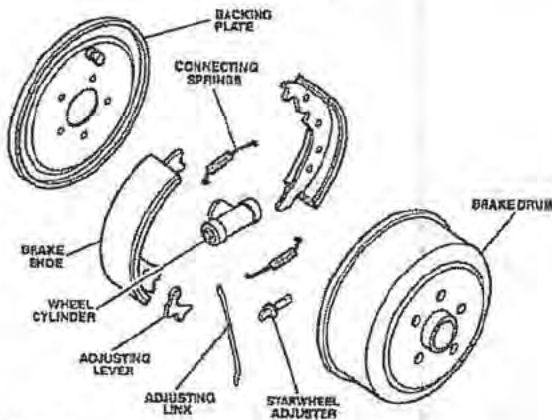

SUSPENSION

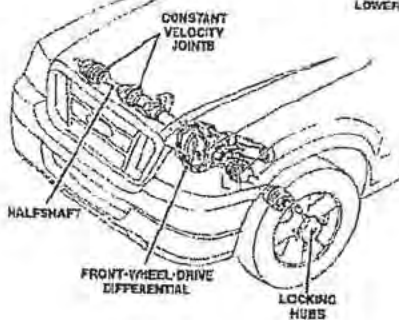
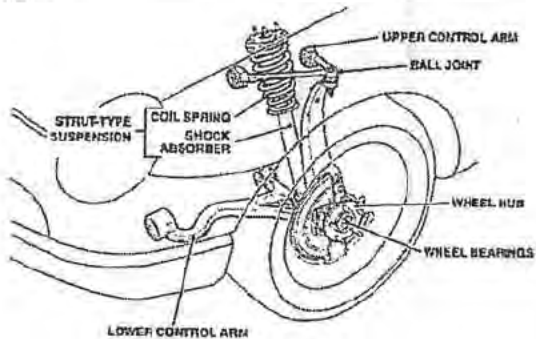
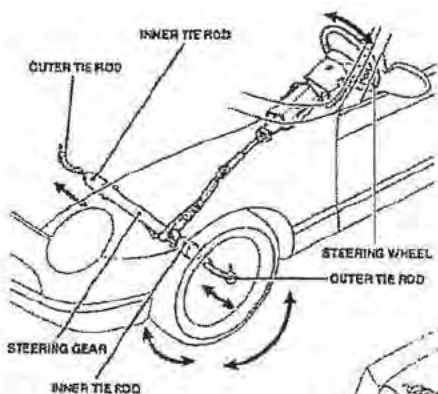

VEHICLE REPORT CARD



FORD SERVICE

MULTI-POINT INSPECTION

FORD MOTOR COMPANY

Date: _____ RO/Tag #: _____
 Name: _____
 Email: _____
 Year/Make/Model: 06 _____
 VIN #: _____ Plate #: _____
 Odometer: 39,950 Inspect. Month: _____
 Owner Advantage Rewards® #: _____ Service Balance: _____
 Ford Extended Service Plan: YES NO
 SYNC® MyFord Touch version current: YES NO N/A

LEGEND May contribute to vehicle efficiency and promote a greener environment
 Checked and OK at this time May require future attention Requires immediate attention

EXTERIOR BODY

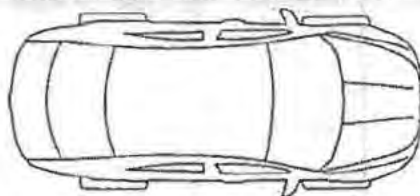

Note any existing exterior body damage or defects on diagram

SYSTEMS / COMPONENTS

LIGHTS / WINDSHIELD		SERVICED
<input checked="" type="checkbox"/>	Operation of horn, interior lights, exterior lamps, turn signals, hazard and brake lamps	<input type="checkbox"/>
<input checked="" type="checkbox"/>	Windshield for cracks, chips and pitting	<input type="checkbox"/>
BELTS / HOSES / MOUNTS		SERVICED
<input checked="" type="checkbox"/>	HVAC system and hoses / lines for leaks and/or damage	<input type="checkbox"/>
<input checked="" type="checkbox"/>	Engine Cooling System, radiator, hoses and clamps	<input type="checkbox"/>
<input checked="" type="checkbox"/>	Accessory drive belt(s)	<input type="checkbox"/>
BRAKE SYSTEM		SERVICED
<input checked="" type="checkbox"/>	Brake system (including lines, hoses, and parking brake)	<input type="checkbox"/>
STEERING / SUSPENSION		SERVICED
<input checked="" type="checkbox"/>	Shocks / struts and other suspension components for leaks and/or damage	<input type="checkbox"/>
<input checked="" type="checkbox"/>	Steering, steering linkages and ball joints (visual)	<input type="checkbox"/>
EXHAUST SYSTEM		SERVICED
<input checked="" type="checkbox"/>	Exhaust system and heat shield (leaks, damage, loose parts)	<input type="checkbox"/>
TRANSMISSION / DRIVE AXLE		SERVICED
<input checked="" type="checkbox"/>	Clutch operation (if equipped)	<input type="checkbox"/>
<input checked="" type="checkbox"/>	Constant velocity (CV) drive axle boots (if equipped)	<input type="checkbox"/>
<input checked="" type="checkbox"/>	Drive shaft, transmission, u-joint and shift linkage (if equipped) and lubricate (as needed)	<input type="checkbox"/>

SCHEDULED MAINTENANCE ITEMS*

DUE	SERVICED	DUE	SERVICED
<input checked="" type="checkbox"/> THE WORKS	<input checked="" type="checkbox"/>	<input checked="" type="checkbox"/> Engine Air Filter	<input checked="" type="checkbox"/>
<input checked="" type="checkbox"/> Oil Change & Filter	<input checked="" type="checkbox"/>	<input checked="" type="checkbox"/> Engine Coolant	<input type="checkbox"/>
<input checked="" type="checkbox"/> Tire Rotation	<input checked="" type="checkbox"/>	<input checked="" type="checkbox"/> Transmission Fluid &/or Filter	<input type="checkbox"/>
<input checked="" type="checkbox"/> Multi-Point Inspection	<input checked="" type="checkbox"/>	<input checked="" type="checkbox"/> Cabin Air Filter	<input checked="" type="checkbox"/>
<input checked="" type="checkbox"/> Fuel Filter	<input type="checkbox"/>	<input checked="" type="checkbox"/> Spark Plugs	<input checked="" type="checkbox"/>
<input type="checkbox"/>	<input type="checkbox"/>	<input type="checkbox"/>	<input type="checkbox"/>

*This is only a partial list of vehicle maintenance items and is NOT all-inclusive. Please consult your Owner's Manual or visit FordOwner.com for vehicle-specific maintenance requirements.

FLUID LEVELS SERVICED

Oil and/or fluid leaks

OK	FILL	OK	FILL	OK	FILL
<input checked="" type="checkbox"/>	<input type="checkbox"/>	<input checked="" type="checkbox"/>	<input type="checkbox"/>	<input checked="" type="checkbox"/>	<input type="checkbox"/>
Engine Oil		Power Steering		Transmission (if equipped with dipstick)	
<input checked="" type="checkbox"/>	<input type="checkbox"/>	<input checked="" type="checkbox"/>	<input type="checkbox"/>	<input checked="" type="checkbox"/>	<input type="checkbox"/>
Brake Reservoir		Window Washer		Coolant Recovery Reservoir	

WIPER BLADES SERVICED

Test Performed Front Rear

BATTERY SERVICED

State of Health Battery Condition

0% 100%

Factory spec cold cranking amps _____ Actual cold cranking amps _____

TIRE / BRAKE WEAR

TIRE TREAD	7/32" and greater	4/32" to 6/32"	3/32" and less
BRAKE LINING	Over 2mm or 7/32" (Disc) or Over 2mm or 3/12" (Drum)	3 to 5mm or 4/32" to 7/32" (Disc) or 1.01 to 2mm (Drum) or 2/32" to 3/32"	Less than 2mm or 4/32" (Disc) or 1mm or 2/32" or less (Drum)
TIRE WEAR INDICATES	<input checked="" type="checkbox"/>	<input checked="" type="checkbox"/>	<input checked="" type="checkbox"/>
<input type="checkbox"/> Alignment check needed	<input type="checkbox"/>	<input type="checkbox"/>	<input type="checkbox"/>
<input type="checkbox"/> Wheel balance needed	<input type="checkbox"/>	<input type="checkbox"/>	<input type="checkbox"/>
<input type="checkbox"/> Brake measurements not taken this service visit	<input type="checkbox"/>	<input type="checkbox"/>	<input type="checkbox"/>
LEFT FRONT <input checked="" type="checkbox"/> SERVICED	<input checked="" type="checkbox"/>	<input checked="" type="checkbox"/>	<input checked="" type="checkbox"/>
<input checked="" type="checkbox"/>	Tire Tread Depth <u>5</u> /32" Tire Age _____	<input checked="" type="checkbox"/>	Tire Tread Depth <u>4</u> /32" Tire Age _____
<input checked="" type="checkbox"/>	Tire Wear Pattern / Damage	<input checked="" type="checkbox"/>	Tire Wear Pattern / Damage
<input checked="" type="checkbox"/>	Tire Pressure set to factory-recommended PSI	<input checked="" type="checkbox"/>	Tire Pressure set to factory-recommended PSI
<input checked="" type="checkbox"/>	Brake Lining <u>8</u> mm /32"	<input checked="" type="checkbox"/>	Brake Lining <u>8</u> mm /32"
LEFT REAR <input checked="" type="checkbox"/> SERVICED	<input checked="" type="checkbox"/>	<input checked="" type="checkbox"/>	<input checked="" type="checkbox"/>
<input checked="" type="checkbox"/>	Tire Tread Depth <u>4</u> /32" Tire Age _____	<input checked="" type="checkbox"/>	Tire Tread Depth <u>4</u> /32" Tire Age _____
<input checked="" type="checkbox"/>	Tire Wear Pattern / Damage	<input checked="" type="checkbox"/>	Tire Wear Pattern / Damage
<input checked="" type="checkbox"/>	Tire Pressure set to factory-recommended PSI	<input checked="" type="checkbox"/>	Tire Pressure set to factory-recommended PSI
<input checked="" type="checkbox"/>	Brake Lining <u>5</u> mm /32"	<input checked="" type="checkbox"/>	Brake Lining <u>5</u> mm /32"
RIGHT FRONT <input checked="" type="checkbox"/> SERVICED	<input checked="" type="checkbox"/>	<input checked="" type="checkbox"/>	<input checked="" type="checkbox"/>
<input checked="" type="checkbox"/>	Tire Tread Depth <u>5</u> /32" Tire Age _____	<input checked="" type="checkbox"/>	Tire Tread Depth <u>4</u> /32" Tire Age _____
<input checked="" type="checkbox"/>	Tire Wear Pattern / Damage	<input checked="" type="checkbox"/>	Tire Wear Pattern / Damage
<input checked="" type="checkbox"/>	Tire Pressure set to factory-recommended PSI	<input checked="" type="checkbox"/>	Tire Pressure set to factory-recommended PSI
<input checked="" type="checkbox"/>	Brake Lining <u>8</u> mm /32"	<input checked="" type="checkbox"/>	Brake Lining <u>8</u> mm /32"
RIGHT REAR <input checked="" type="checkbox"/> SERVICED	<input checked="" type="checkbox"/>	<input checked="" type="checkbox"/>	<input checked="" type="checkbox"/>
<input checked="" type="checkbox"/>	Tire Tread Depth <u>4</u> /32" Tire Age _____	<input checked="" type="checkbox"/>	Tire Tread Depth <u>4</u> /32" Tire Age _____
<input checked="" type="checkbox"/>	Tire Wear Pattern / Damage	<input checked="" type="checkbox"/>	Tire Wear Pattern / Damage
<input checked="" type="checkbox"/>	Tire Pressure set to factory-recommended PSI	<input checked="" type="checkbox"/>	Tire Pressure set to factory-recommended PSI
<input checked="" type="checkbox"/>	Brake Lining <u>5</u> mm /32"	<input checked="" type="checkbox"/>	Brake Lining <u>5</u> mm /32"
SPARE TIRE <input checked="" type="checkbox"/> SERVICED	<input checked="" type="checkbox"/>	<input checked="" type="checkbox"/>	<input checked="" type="checkbox"/>
<input checked="" type="checkbox"/>	Tire Pressure set	<input checked="" type="checkbox"/>	Tire Age _____

NOTE: Tires should be replaced after 6 years regardless of tread wear, including the spare, even if it has not been used.

FordOwner.com
One site for all your vehicle needs

Advisor: _____
 Technician: _____
 Customer Signature: _____

Customer Copy

CUSTOMER #:

AutoNation

AutoNation Ford Tustin

#2 AUTO CENTER DR. TUSTIN, CA 92782

(714) 832-3300

www.autonation.com

WORKORDER

PAGE 1

SERVICE ADVISOR: 2224 CIESLA, MARK

COLOR	YEAR	MAKE/MODEL	VIN	LICENSE	MILEAGE IN/OUT	TAG
STERLING G	13	FORD EXPLORER	1FM5K7D84DC		39950/	16/56
DEL DATE	PROD DATE	WARR EXP	PROMISED	PO NO.	RATE	PAYMENT
15JUN13 DD			** WAITER **			CASH
R.O. OPENED	READY	OPTIONS: SOLD-STK:DG		DLR:30956		
04NOV2015 10:37		ENG:3.5L_V6_Cyl TRN:A				

LINE OF CODE	TECH...	TYPE	DESCRIPTIONS/INSTRUCTIONS
# A	VCPTR	IPXV	Perform VCP Lube, Oil, Filter and Tire Rotation
			VCPFILTER OIL FILTER (QTY 1)
			VCP OIL OIL (QTY 1)

B MULTI-A IFEPS MULTI-POINT VEHICLE INSPECTION AUTHORIZED BY CUSTOMER, TIRE PRESSURE READINGS:
 RF _____ LF _____ RR _____ LR _____

THANK YOU FOR YOUR BUSINESS. IF YOU ARE NOT COMPLETELY SATISFIED FOR ANY REASON, CONTACT KEVIN BEGANE

TECH #	TECH. NO LAST 4 - SOC. SEC.	TECH #	TECH. NO LAST 4 - SOC. SEC.
CUST. CONCERN CODE		CUST. CONCERN CODE	
OPERATION	TIME	CONDITION	OPERATION
TECH #	TECH. NO LAST 4 - SOC. SEC.	TECH #	TECH. NO LAST 4 - SOC. SEC.
CUST. CONCERN CODE		CUST. CONCERN CODE	
OPERATION	TIME	CONDITION	OPERATION

PRELIMINARY ESTIMATE \$ 47.39

AUTHORIZED BY X

REVISED ESTIMATE (1)	DATE	TIME	BY
REVISED ESTIMATE (2)			
REVISED ESTIMATE (3)			

I HEREBY ACKNOWLEDGE THAT I WAS NOTIFIED & GAVE ORAL APPROVAL OF THE ABOVE REVISED ESTIMATES:

X

CUSTOMER

CUSTOMER COPY

DEALER LIMITED WARRANTY TO CUSTOMERS PURCHASING PARTS AND ACCESSORIES FROM FORD AND LINCOLN DEALERSHIPS

Under the Magnuson-Moss Act (Public Law #93-637), dealers who offer written warranties on retail products selling for more than \$15.00 must meet certain warranty requirements and must inform the purchaser about the warranty.

Coverage Statement

This dealership warrants that Ford parts and accessories found to be defective in factory-supplied material or workmanship will be repaired, replaced, or exchanged as follows:

- 1. Ford, Lincoln, Mercury Cars & Light Trucks:
 - Repairs prior to 10/1/2013 - 12 months/12,000 miles, whichever comes first from the part or accessory warranty start date.
 - Repairs on or after 10/1/2013 - 24 months/unlimited miles from the part or accessory warranty start date.
- 2. 650 and Higher Series Trucks
 - 12 months/unlimited miles, from the part or accessory warranty start date.

NOTE: See Lifetime Warranty Coverages in this section.

The purchaser must return the defective part or accessory to the dealer's place of business during regular business hours for repair or replacement. The purchaser must present the original customer sale receipt or repair order for a dealer-installed part or accessory in order to validate the date and mileage on the vehicle at the date of sale or installation of the original part or accessory. The servicing dealer is required to retain a copy of the original receipt in the customer's service file. If the purchaser is traveling or has moved to a different locality, any authorized Ford Motor Company dealer will fulfill this warranty. THIS WARRANTY DOES NOT COVER PARTS AND ACCESSORIES THAT FAIL DUE TO ABUSE, MISUSE, NEGLIGENCE, ALTERATION, ACCIDENT, RACING, OR THE USE OF NON-FORD PARTS, OR PARTS AND ACCESSORIES INSTALLED IN VEHICLES OTHER THAN THOSE LISTED IN THE COVERAGE STATEMENT INCLUDING OTHER FORD MOTOR COMPANY BRANDS, OR PARTS WHICH ARE REPLACED AS A PART OF NORMAL MAINTENANCE. TO THE EXTENT ALLOWED BY LAW, LOSS OF TIME, INCONVENIENCE, LOSS OF USE OF THE VEHICLE, COMMERCIAL LOSS, AND CONSEQUENTIAL DAMAGES ARE NOT COVERED.

THERE IS NO OTHER EXPRESS WARRANTY OF FORD MOTOR COMPANY SUPPLIED REPLACEMENT PARTS AND ACCESSORIES. ANY IMPLIED WARRANTY OF MERCHANTABILITY OR FITNESS IS LIMITED TO THE DURATION OF THIS WRITTEN WARRANTY. SOME STATES DO NOT ALLOW THE EXCLUSION OR LIMITATION OF CONSEQUENTIAL OR INCIDENTAL DAMAGES OR LIMITATIONS ON HOW LONG AN IMPLIED WARRANTY LASTS. THEREFORE, THE ABOVE LIMITATIONS AND EXCLUSIONS MAY NOT ALWAYS APPLY. THIS WARRANTY GIVES YOU SPECIFIC LEGAL RIGHTS. YOU MAY ALSO HAVE OTHER RIGHTS WHICH VARY FROM STATE TO STATE.

UNIQUE WARRANTY COVERAGES:

NOTE: The Warranty Start Date for Parts that are:

- Dealer-Installed: The date of installation.
- Sold Over-the-Counter:
 - To a retail purchaser: The date of sale.
 - To a fleet, general installer or wholesaler: The date the part or accessory is installed (could be later than the date of sale).
- Battery - See Ford Motor Company's Warranty.
- Bed liner and Cargo Liner (Light Truck) **AZ** - Lifetime limited coverage to original purchaser. (Contact the warrantor, Penda at 1-888-FORD-DE1 for authorization/replacement Bedliner and Cargo Liner supplied at no charge by the manufacturer.)
- Belts and Hoses:
 - Sold before 1-1-92: Limited Warranty for parts, parts allowance and labor
 - Sold on or after 1-1-92 and before 10-1-13: 12 months/12,000 miles.

- Bumper-MasterGuard **AZ**: Covered the warrantor, Master Guard at 1-800-844-3634 for a replacement to replace the bumper and for a replacement bumper supplied by Master Guard at no charge. Additional information on Master Guard bumpers can be found in the Accessories section.
- Diesel Engine - Ford New Holland:
 - 6.6L and 7.8L Engine Components: 12 months/unlimited miles.
 - 6.6L and 7.8L Ford remanufactured Engines: 12 months/unlimited miles.
- LIFT Supports - Motorcraft **CZ** - Lifetime Limited Warranty to original purchaser. (Not to be used under the New Vehicle Limited Warranty.)
- Motorcraft Parts - See Ford Motor Company's Warranty.
- Sheet Metal - Lifetime limited coverage (as long as original purchaser owns the vehicle) against rust perforation (excludes parts parts allowance, and labor).
- Shock Absorbers and Struts - Motorcraft **DZ**: For shock absorbers or struts sold on or after October 1, 1997:
 - Private Cars and Light Trucks: Lifetime Limited Warranty to original purchaser.
 - Other than Private Cars and Light Trucks: 24 months or 24,000 miles, whichever occurs first.For shock absorbers or struts sold before October 1, 1997:
 - AA, AS, AT, AH, AX Series:
 - Private Cars and Light Trucks: Lifetime Limited Warranty to original purchaser.
 - Other than Private Cars and Light Trucks: 24 months, 24,000 miles, whichever occurs first.
 - AJ Series (Cartridges and Assemblies): 12 months/24,000 miles, whichever occurs first.
 - AY Series: 24 months/24,000 miles, whichever occurs first.
- Spark Plug Wiring Set (Complete Set) **CZ**:
 - Normal Service: Lifetime Limited Warranty to original purchaser.
 - Severe Service (e.g., Police/Taxi): 12 months or 12,000 miles.
- Tires - No Service Part Warranty Coverage.
- Vehicle Security System (Ford Alarm - Dealer Installed) **AZ**: Lifetime Limited Warranty on parts. Contact supplier at 800-FORD-KEY (3673-5399) for parts replacement.
- Walker Exhaust SDS program **DZ** Effective November 1, 1993, a Lifetime Limited Warranty is provided on all Walker replacement mufflers against rust through, blowouts and defects in material and workmanship for as long as the original purchaser of the muffler owns the vehicle. A 12 month/12,000 mile warranty is also provided on muffler system replacement pipes, accessories and catalytic converters.

Special Notes:

- A/ Labor is covered up to 12 months/12,000 miles, whichever occurs first, if the vehicle is beyond the Bumper to Bumper warranty period - no parts allowance at any time.
- B/ Same engine components as those covered by the powertrain warranty on 650 and higher series trucks.
- C/ Labor and parts allowance are covered up to 12 months/12,000 miles, whichever occurs first, if the vehicle is beyond the Bumper-to-Bumper warranty period.
- D/ Labor is covered up to 12 months/12,000 miles, whichever occurs first, if the vehicle is beyond the Bumper to Bumper warranty period.

ALL OTHER PARTS AND ALL SERVICE PROVIDED AS IS BY DEALERSHIP: EXCEPT FOR THE PARTS AND ACCESSORIES COVERED PURSUANT TO THE EXPRESS LIMITED WARRANTY AS SET FORTH ABOVE, ALL PARTS AND ACCESSORIES ARE SOLD AND ALL REPAIRS AND SERVICES ARE PROVIDED BY OUR DEALERSHIP AS IS. OUR DEALERSHIP DISCLAIMS ALL WARRANTIES, EXPRESS AND IMPLIED, INCLUDING THE IMPLIED WARRANTIES OF MERCHANTABILITY AND FITNESS FOR A PARTICULAR PURPOSE. IN CONNECTION WITH THE SALE OF PARTS AND ACCESSORIES AND/OR SERVICES AND REPAIRS PERFORMED BY OUR DEALERSHIP THE ENTIRE RISK AS TO THE QUALITY AND PERFORMANCE OF THE VEHICLE AND PARTS AND ACCESSORIES IS WITH THE CUSTOMER AND, IF APPLICABLE, THE MANUFACTURER. IF THE VEHICLE OR ANY INSTALLED PARTS OR ACCESSORIES SHOULD PROVE DEFECTIVE FOLLOWING THEIR PURCHASE, THE CUSTOMER AND POSSIBLY THE MANUFACTURER AND NOT THE DEALERSHIP ASSUME THE ENTIRE COST OF ANY NECESSARY SERVICING OR REPAIR. CUSTOMER SHALL NOT BE ENTITLED TO RECOVER FROM THE DEALERSHIP ANY CONSEQUENTIAL DAMAGES, DAMAGES TO PROPERTY, DAMAGES FOR LOSS OF USE, LOSS OF TIME, LOSS OF PROFITS OR INCOME, OR ANY OTHER INCIDENTAL DAMAGES.

HAZARDOUS WASTE DISPOSAL COSTS: A charge may be assessed to cover costs associated with the handling, management and disposal of toxic waste or hazardous substances under California and Federal Law.

TO OUR SERVICE CUSTOMERS:

1. Our Dealership's usual charges for labor are not based on actual mechanic's time, but are simply our prices for particular jobs.
2. You will be charged no more than the estimated price approved by you. However, if we discover that different or additional repairs are necessary, you will be contacted for your advance approval of a revised estimate.
3. Customer is hereby notified that the vehicle and any of its contents are not insured or protected to the amount of the actual cash value thereof, or otherwise, against loss occasioned by theft, fire or vandalism while the property remains with the Dealership.
4. Customer states no articles of personal property have been left in the vehicle and dealer is not responsible for inspection thereof.
5. The repair of this vehicle and completion date are subject to the availability of labor and parts. The Dealership is not responsible for unavailability of parts or delays in parts shipment beyond the Dealership's control.
6. Due to the type of service requested some repairs must be substituted.
7. All labor and materials will be paid for in cash unless Dealer agrees to other payment arrangements in advance. Notice as used under PAYMENT TERMS on the front side hereof will be deemed to have been given upon deposit in the United States mail, postage prepaid, of written notification to that effect addressed to the customer at the address given on the front side hereof.
8. If the vehicle described herein is not called for within three (3) days after such notice is given, a daily storage fee will be charged.
9. The Dealership is authorized to deliver the vehicle described herein or any of its contents to any person presenting this receipt.
10. In addition to any and all other legal remedies available, I authorize the Dealership to have a lien on the vehicle described herein for all charges for repairs, including labor and parts, storage and/or towing, and to enforce such lien. The Dealership is hereby expressly authorized to sell said vehicle at public auction after giving a twenty (20) day written notice by certified mail to the legal owner, registered owner, or Department of Motor Vehicles or intent to do so. On the sale date, the vehicle shall be sold to the highest cash bidder and the proceeds of sale must be used first to satisfy the lien for all storage costs and costs incident to sale, and the balance shall be forwarded to the legal owner, or if none, to the registered owner, or if the address is unknown, I shall be forwarded to the Department of Motor Vehicles. Said expenses for sale shall also include a reasonable attorney's fees, which may be necessarily incurred.
11. If any such charges remain unpaid for thirty (30) days after such request for payment, the Dealership may also refer such charges to its attorneys for collection and the customer shall pay a reasonable attorney's fee.
12. The Power-of-Attorney granted on the front of this Repair Order/Invoice shall be irrevocable and shall remain in effect for so long as there is an outstanding amount due under this Repair Order/Invoice.
13. Remanufactured and refurbished parts that meet manufacturer approved source part requirements may be installed at our discretion. Additional information is available upon request.
14. I authorize the retrieval of on-board data as needed to facilitate vehicle repair, as well as sharing that data with the vehicle manufacturer for diagnostic and research purposes.

STATEMENT CONCERNING AMENDMENTS TO THE SONG-BEVERLY WARRANTY ACT AS FOLLOWS:

"A buyer of this product in California has the right to have this product serviced or repaired during the warranty period. The warranty period will be extended for the number of whole days that the product has been out of the buyer's hands for warranty repairs. If a defect exists within the warranty period, the warranty will not expire until the defect has been fixed. The warranty period will also be extended if the warranty repairs have not been performed due to delays caused by circumstances beyond the control of the buyer, or if the warranty repairs did not remedy the defect and the buyer notifies the manufacturer or seller of the failure of the repairs within 60 days after they were completed. If, after a reasonable number of attempts, the defect has not been fixed, the buyer may return this product for a replacement or a refund subject, in either case, to deduction of a reasonable charge for usage. This time extension does not affect the protections or remedies the buyer has under other laws."

WARNING

Motor vehicles contain chemicals known to the State of California to cause cancer and birth defects or other reproductive harm. These chemicals are contained in many vehicle components and replacement parts, vehicle fluids, and paints and materials used to maintain vehicles, including, but not limited to, fuel, oil, batteries, brakes, and wheel balancing weights. When you service, clean or maintain your car, you will be exposed to listed chemicals contained in used oil, waste and replacement fluids, fumes, grease, grime, touch-up paint, certain replacement parts, and particulates from component wear. When we service your car, we will return used components to you upon request. Used parts and components contain chemicals known to the State of California to cause cancer and birth defects or other reproductive harm.

To minimize your exposure when servicing, maintaining or cleaning your vehicle: 1) work in a well ventilated area; 2) do not smoke, drink or eat while working; 3) wash your hands when finished or when taking a break; and 4) follow all manufacturer instructions pertaining to proper use and maintenance of motor vehicles and vehicle components.

(Posted in accordance with Proposition 65 in Cal. Health & Safety Code §25249.5 et seq)

State of California - Department of Consumer Affairs: NOTICE TO MOTORISTS:

If your vehicle fails Smog Check, new federal law requires you to make necessary repairs to reduce your vehicle's emissions to required levels. If your vehicle is not under warranty and you have spent up to or more than the amount required by law for appropriate emissions-related repairs at a licensed Smog Check repair facility, you may be eligible for a one-time waiver. Repair waivers will NOT be issued for:

- Vehicles with missing, modified or disconnected emissions control equipment, regardless of the costs to make repairs;
- Vehicles identified as "Gross Polluters" - vehicles which have much higher emissions than properly maintained vehicles in their class;
- Vehicles that obtained a repair waiver after January 1, 1995, in their most recent biennial inspection or transfer of ownership.

Two consecutive repair waivers will not be issued after January 1, 1995.

If you obtain a smog certificate by means of fraud, you may be subject to a civil penalty of up to \$2500 per day of subject violation. Also, you may be subject to criminal prosecution. For further information, call the Department of Consumer Affairs toll-free at 1-800-952-5210.

BY LAW, YOU MAY CHOOSE ANOTHER LICENSED SMOG CHECK FACILITY TO PERFORM ANY NEEDED REPAIRS OR ADJUSTMENTS WHICH THE SMOG CHECK TEST INDICATES ARE NECESSARY.



R/O# [REDACTED] Customer Name _____ ASM 4 /# _____

Mileage _____ Vehicle Description V70 Tech Zia /# _____

	N/A	Checks O.K.	Needs Attention	Needs Immediate Attention		N/A	Checks O.K.	Needs Attention	Needs Immediate Attention	TIRE AND BRAKE INSPECTION:	
Operation of Lights & Inspect Lens		<input checked="" type="checkbox"/>			Battery & Cable Inspection		<input checked="" type="checkbox"/>			LF	RF
Condition of Wiper Inserts		<input checked="" type="checkbox"/>			Fluid Leaks		<input checked="" type="checkbox"/>			<input type="checkbox"/> Brake Lining <u>90</u> mm	<input type="checkbox"/> Brake Lining <u>90</u> mm
Condition of Suspension		<input checked="" type="checkbox"/>			Engine Oil		<input checked="" type="checkbox"/>			<input checked="" type="checkbox"/> Tire Tread <u>32</u> nds	<input checked="" type="checkbox"/> Tire Tread <u>32</u> nds
Condition of Drive Axles/Boots		<input checked="" type="checkbox"/>			Brake Fluid		<input checked="" type="checkbox"/>			<input checked="" type="checkbox"/> Wear Pattern	<input checked="" type="checkbox"/> Wear Pattern
AC & Heating Inspection		<input checked="" type="checkbox"/>			Transmission Fluid		<input checked="" type="checkbox"/>			<input type="checkbox"/> Tire Pressure <u>36</u> psi	<input type="checkbox"/> Tire Pressure <u>32</u> psi
Exhaust System Inspection		<input checked="" type="checkbox"/>			Differential Fluid		<input checked="" type="checkbox"/>			Lowest Brake Lining - mm: _____ BK_(2,3,4,5,6,8,10,12)	
Condition of Hoses		<input checked="" type="checkbox"/>			Power Steering Fluid		<input checked="" type="checkbox"/>			Lowest Tread Depth - 32nds: _____ TRT_(1,2,3,4,5,6,7,8,10,12)	
Condition of Drive Belts		<input checked="" type="checkbox"/>			Windshield Washer Fluid		<input checked="" type="checkbox"/>			LR	RR
Condition of Air Filter		<input checked="" type="checkbox"/>			Engine Coolant		<input checked="" type="checkbox"/>			<input type="checkbox"/> Brake Lining <u>60</u> mm	<input type="checkbox"/> Brake Lining <u>60</u> mm
Condition of Fuel System		<input checked="" type="checkbox"/>			Cabin Filter		<input checked="" type="checkbox"/>			<input checked="" type="checkbox"/> Tire Tread <u>32</u> nds	<input checked="" type="checkbox"/> Tire Tread <u>32</u> nds
										<input checked="" type="checkbox"/> Wear Pattern	<input checked="" type="checkbox"/> Wear Pattern
										<input type="checkbox"/> Tire Pressure <u>35</u> psi	<input type="checkbox"/> Tire Pressure <u>32</u> psi

PRIMARY ITEM CONCERNS

Item, Description & Part Number	Total \$\$	SOP	Authorized	
			Y	N
			Y	N
			Y	N
			Y	N
			Y	N
			Y	N
			Y	N

ADDITIONAL SERVICE RECOMMENDED

Safety	Drivability	Reliability	Item, Description & Part Number	Total \$\$	SOP	Authorized	
<input type="checkbox"/>	<input type="checkbox"/>	<input type="checkbox"/>				Y	N
<input type="checkbox"/>	<input type="checkbox"/>	<input type="checkbox"/>				Y	N
<input type="checkbox"/>	<input type="checkbox"/>	<input type="checkbox"/>				Y	N
<input type="checkbox"/>	<input type="checkbox"/>	<input type="checkbox"/>				Y	N
<input type="checkbox"/>	<input type="checkbox"/>	<input type="checkbox"/>				Y	N
<input type="checkbox"/>	<input type="checkbox"/>	<input type="checkbox"/>				Y	N
<input type="checkbox"/>	<input type="checkbox"/>	<input type="checkbox"/>				Y	N
<input type="checkbox"/>	<input type="checkbox"/>	<input type="checkbox"/>				Y	N
<input type="checkbox"/>	<input type="checkbox"/>	<input type="checkbox"/>	TOTALS			Y	N

Method of Customer Approval: _____ Time and Date of Approval: _____

The Vehicle Safety and Condition Inspection ("VSCI") is provided as a complimentary service to you and is limited in scope. There may be mechanical, equipment or system issues which were not detected by the VSCI. A complete vehicle diagnostic/inspection is available for an additional charge.

Est. Tax & Misc. _____

GRAND TOTAL: _____

DEALER LIMITED WARRANTY TO CUSTOMERS PURCHASING PARTS AND ACCESSORIES FROM FORD AND LINCOLN DEALERSHIPS

Under the Magnuson-Moss Act (Public Law #93-637), dealers who offer written warranties on retail products selling for more than \$15.00 must meet certain warranty requirements and must inform the purchaser about the warranty.

Coverage Statement

This dealership warrants that Ford parts and accessories found to be defective in factory-supplied material or workmanship will be repaired, replaced, or exchanged as follows:

1. Ford, Lincoln, Mercury Cars & Light Trucks:

- Repairs prior to 10/1/2013 - 12 months/12,000 miles, whichever comes first from the part or accessory warranty start date.
- Repairs on or after 10/1/2013 - 24 months/unlimited miles from the part or accessory warranty start date.

2. 650 and Higher Series Trucks:

- 12 months/unlimited miles from the part or accessory warranty start date.

NOTE: See Unique Warranty Coverages in this section.

The purchaser must return the defective part or accessory to the dealer's place of business during regular business hours for repair or replacement. The purchaser must present the original customer sale receipt or repair order to a dealer-installed part or accessory in order to validate the date and mileage on the vehicle at the date of sale or installation of the original part or accessory. The servicing dealer is required to retain a copy of the original receipt in the customer's service file. If the purchaser is traveling or has moved to a different locality, any authorized Ford Motor Company dealer will fulfill this warranty. THIS WARRANTY DOES NOT COVER PARTS AND ACCESSORIES THAT FAIL DUE TO ABUSE, MISUSE, NEGLIGENCE, ALTERATION, ACCIDENT, PAGING, OR THE USE OF NON-FORD PARTS, OR PARTS AND ACCESSORIES INSTALLED IN VEHICLES OTHER THAN THOSE LISTED IN THE COVERAGE STATEMENT INCLUDING OTHER FORD MOTOR COMPANY BRANDS, OR PARTS WHICH ARE REPLACED AS A PART OF NORMAL MAINTENANCE. TO THE EXTENT ALLOWED BY LAW, LOSS OF TITLE, INCONVENIENCE, LOSS OF USE OF THE VEHICLE, COMMERCIAL LOSS, AND CONSEQUENTIAL DAMAGES ARE NOT COVERED.

THERE IS NO OTHER EXPRESS WARRANTY OF FORD MOTOR COMPANY-SUPPLIED REPLACEMENT PARTS AND ACCESSORIES. ANY IMPLIED WARRANTY OF MERCHANTABILITY OR FITNESS IS LIMITED TO THE DURATION OF THIS WRITTEN WARRANTY. SOME STATES DO NOT ALLOW THE EXCLUSION OR LIMITATION OF CONSEQUENTIAL OR INCIDENTAL DAMAGES OR LIMITATIONS ON HOW LONG AN IMPLIED WARRANTY LASTS; THEREFORE, THE ABOVE LIMITATIONS AND EXCLUSIONS MAY NOT ALWAYS APPLY. THIS WARRANTY GIVES YOU SPECIFIC LEGAL RIGHTS YOU MAY ALSO HAVE OTHER RIGHTS WHICH VARY FROM STATE TO STATE.

NOTE: The Warranty Start Date for Parts that are:

- Dealer-installed: The date of installation.
- Sold Over-the-Counter:
 - To a retail purchaser: The date of sale.
 - To a fleet, general installer or wholesaler: The date the part or accessory is installed (could be later than the date of sale).
- Battery - See Ford Motor Company's Warranty.
- Bed liner and Cargo Liner (Light Truck) A: Lifetime limited coverage to original purchaser. (Contact the warrantor, Parts at 1-866-FORD-DCI for authorization for replacement Bedliner and Cargo Liner supplied at no charge by the manufacturer.)
- Bells and Hoses:
 - Sold before 1-1-92: Limited Warranty for parts, parts allowance and labor.
 - Sold on or after 1-1-92 and before 10-1-13: 12 months/12,000 miles.

ALL OTHER PARTS AND ALL SERVICE PROVIDED AS IS BY DEALERSHIP; EXCEPT FOR THE PARTS AND ACCESSORIES COVERED PURSUANT TO THE EXPRESS LIMITED WARRANTY AS SET FORTH ABOVE. ALL PARTS AND ACCESSORIES ARE SOLD AND ALL REPAIRS AND SERVICES ARE PROVIDED BY OUR DEALERSHIP AS IS. OUR DEALERSHIP DISCLAIMS ALL WARRANTIES, EXPRESS AND IMPLIED, INCLUDING THE IMPLIED WARRANTIES OF MERCHANTABILITY AND FITNESS FOR A PARTICULAR PURPOSE, IN CONNECTION WITH THE SALE OF PARTS AND ACCESSORIES AND/OR SERVICES AND REPAIRS PERFORMED BY OUR DEALERSHIP. THE ENTIRE RISK AS TO THE QUALITY AND PERFORMANCE OF THE VEHICLE AND PARTS AND ACCESSORIES IS WITH THE CUSTOMER AND, IF APPLICABLE, THE MANUFACTURER. IF THE VEHICLE OR ANY INSTALLED PARTS OR ACCESSORIES SHOULD PROVE DEFECTIVE FOLLOWING THEIR PURCHASE, THE CUSTOMER AND POSSIBLY THE MANUFACTURER AND NOT THE DEALERSHIP ASSUME THE ENTIRE COST OF ANY NECESSARY SERVICING OR REPAIR. CUSTOMER SHALL NOT BE ENTITLED TO RECOVER FROM THE DEALERSHIP ANY CONSEQUENTIAL DAMAGES, DAMAGES TO PROPERTY, DAMAGES FOR LOSS OF USE, LOSS OF TIME, LOSS OF PROFITS OR INCOME, OR ANY OTHER INCIDENTAL DAMAGES.

HAZARDOUS WASTE DISPOSAL COSTS: A charge may be assessed to cover costs associated with the handling, management and disposal of toxic waste or hazardous substances under California and Federal Law.

TO OUR SERVICE CUSTOMERS:

- Our Dealership's usual charges for labor are not based on actual mechanic's time, but are simply our prices for particular jobs.
- You will be charged no more than the estimated price approved by you. However, if we discover that different or additional repairs are necessary, you will be contacted for your advance approval of a revised estimate.
- Customer is hereby notified that the vehicle and any of its contents are not insured or protected to the amount of the actual cash value thereof, or otherwise, against loss occasioned by theft, fire or vandalism while the property remains with the Dealership.
- Customer states no articles of personal property have been left in the vehicle and dealer is not responsible for inspection thereof.
- The repair of this vehicle and completion date are subject to the availability of labor and parts. The Dealership is not responsible for unavailability of parts or delays in parts shipment beyond the Dealership's control.
- Due to the type of service requested some repairs must be sublet.
- All labor and materials will be paid for in cash unless Dealer agrees to other payment arrangements in advance. Notice as used under PAYMENT TERMS on the front side hereof will be deemed to have been given upon deposit in the United States mail, postage prepaid, of written notification to that effect addressed to the customer at the address given on the front side hereof.
- If the vehicle described herein is not called for within three (3) days after such notice is given, a daily storage fee will be charged.
- The Dealership is authorized to deliver the vehicle described herein or any of its contents to any person presenting this receipt.
- In addition to any and all other legal remedies available, I authorize the Dealership to have a lien on the vehicle described herein for all charges for repairs, including labor and parts, storage and/or towing, and to enforce such lien. The Dealership is hereby expressly authorized to sell said vehicle at public auction after giving a twenty (20) day written notice by certified mail to the legal owner, registered owner, and Department of Motor Vehicles of intent to do so. On the sale date, the vehicle shall be sold to the highest cash bidder and the proceeds of sale must be used first to satisfy the lien plus storage costs and costs incident to sale, and the balance shall be forwarded to the legal owner, or if none, to the registered owner, or if the address is unknown, it shall be forwarded to the Department of Motor Vehicles. Said expenses for sale shall also include a reasonable attorney's fees, which may be necessarily incurred.
- If any such charges remain unpaid for thirty (30) days after such request for payment, the Dealership may also refer such charges to its attorneys for collection and the customer will pay a reasonable attorney's fee.
- The Power-of-Attorney granted on the front of this Repair Order/Invoice shall be irrevocable and shall remain in effect for so long as there is an outstanding amount due under this Repair Order/Invoice.
- Remanufactured and refurbished parts that meet manufacturer approved source part requirements may be installed at our discretion. Additional information is available upon request.
- I authorize the retrieval of on-board data as needed to facilitate vehicle repair, as well as sharing that data with the vehicle manufacturer for diagnostic and research purposes.

STATEMENT CONCERNING AMENDMENTS TO THE SONG-BEVERLY WARRANTY ACT AS FOLLOWS:

"A buyer of this product in California has the right to have this product serviced or repaired during the warranty period. The warranty period will be extended for the number of whole days that the product has been out of the buyer's hands for warranty repairs. If a defect exists within the warranty period, the warranty will not expire until the defect has been fixed. The warranty period will also be extended if the warranty repairs have not been performed due to delays caused by circumstances beyond the control of the buyer, or if the warranty repairs did not remedy the defect and the buyer notifies the manufacturer or seller of the failure of the repairs within 60 days after they were completed. If, after a reasonable number of attempts, the defect has not been fixed, the buyer may return this product for a replacement or a refund subject, in either case, to deduction of a reasonable charge for usage. This time extension does not affect the protections or remedies the buyer has under other laws."

WARNING

Motor vehicles contain chemicals known to the State of California to cause cancer and birth defects or other reproductive harm. These chemicals are contained in many vehicle components and replacement parts, vehicle fluids, and paints and materials used to maintain vehicles, including, but not limited to, fuel, oil, batteries, brakes, and wheel balancing weights. When you service, clean or maintain your car, you will be exposed to listed chemicals contained in used oil, waste and replacement fluids, fumes, grease, grime, touch-up paint, certain replacement parts, and particulates from component wear. When we service your car, we will return used components to you upon request. Used parts and components contain chemicals known to the State of California to cause cancer and birth defects or other reproductive harm.

To minimize your exposure when servicing, maintaining or cleaning your vehicle: 1) work in a well ventilated area; 2) do not smoke, drink or eat while working; 3) wash your hands when finished or when taking a break; and 4) follow all manufacturer instructions pertaining to proper use and maintenance of motor vehicles and vehicle components.

(Posted in accordance with Proposition 65 in Cal. Health & Safety Code §25249.5 et seq)

State of California - Department of Consumer Affairs: NOTICE TO MOTORISTS:

If your vehicle fails Smog Check, new federal law requires you to make necessary repairs to reduce your vehicle's emissions to required levels. If your vehicle is not under warranty and you have spent up to or more than the amount required by law for appropriate emissions-related repairs at a licensed Smog Check repair facility, you may be eligible for a one-time waiver. Repair waivers will NOT be issued for: Vehicles with missing, modified or disconnected emissions control equipment, regardless of the costs to make repairs; Vehicles identified as "Gross Polluters" - vehicles which have much higher emissions than properly maintained vehicles in their class; Vehicles that obtained a repair waiver after January 1, 1995, in their most recent biennial inspection or transfer of ownership.

Two consecutive repair waivers will not be issued after January 1, 1995.

If you obtain a smog certificate by means of fraud, you may be subject to a civil penalty of up to \$2500 per day of subject violation. Also, you may be subject to criminal prosecution. For further information, call the Department of Consumer Affairs toll-free at 1-800-952-5210.

BY LAW, YOU MAY CHOOSE ANOTHER LICENSED SMOG CHECK FACILITY TO PERFORM ANY NEEDED REPAIRS OR ADJUSTMENTS WHICH THE SMOG CHECK TEST INDICATES ARE NECESSARY.

TO REORDER CALL 866-268-8661 #626514

DealerCAP Copyright © 2013, ADR Inc. All rights reserved. California (01/14)

AutoNation

AutoNation Ford Tustin

#2 AUTO CENTER DR. TUSTIN, CA 92782
 (714) 332-3300
 www.autonation.com

CUSTOMER # [REDACTED]

INVOICE

PAGE 2

DOWNNEY, CA
 HOME [REDACTED]
 BUS: [REDACTED]

SERVICE ADVISOR: 4043 DANIEL TROSS

COLOR	YEAR	MAKE/MODEL	VIN	LICENSE	MILEAGE IN / OUT	TAG	
STERLING G 13		FORD EXPLORER	1FMSK7D84D [REDACTED]		57489 / 57489	[REDACTED]	
DEL. DATE	PROD. DATE	WARR. EXP.	PROMISED	PO NO	RATE	PAYMENT	INV. DATE
15JUN13 DE			17:00 04AUG16			CASH	04AUG16

R.D. OPENED	READY	OPTIONS: SOLD-STR: DGC44915 DLR: 30956
17:34 03AUG16	16:07 04AUG16	ENG: 3.5L V6 Cyl TRN: A

LINE	OPCODE	TECH	TYPE	HOURS	LIST	NET	TOTAL
D	C/S	DRIVERS	SEAT	LUMBAR	SUPPORT	IS	INOP ADVISE
A99 PARTS ON ORDER							
PARTS:	3910	CE				0.00	0.00
	0.00	LABOR:	0.00	OTHER:	0.00	TOTAL LINE D:	0.00

BST: 70.00 03AUG16 17:34 SA: 4043

Dealer is not authorized to perform recall repairs for non-Dealer brand vehicles and Dealer's Vehicle Safety and Condition Inspection and/or service does not include a review of possible pending recalls or service campaigns issued by manufacturers of other makes and models.

PAID

VMC _____ AMEX _____
 DISC _____ ELEC CK _____

AUG 04 2016

CK# _____ CASH _____

B.A.R. #AG126349 E.P.A. #CA0000195214 *I acknowledge notice and oral approval of an increase in the original estimated price.* (signature or initials)	ALL PARTS INSTALLED ARE NEW UNLESS SPECIFIED OTHERWISE. ALL NEW REPLACEMENT PARTS AND LABOR HAVE A LIMITED WARRANTY FOR 12,000 MILES OR 12 MONTHS, WHICHEVER COMES FIRST. PLEASE SEE IMPORTANT INFORMATION ON REVERSE SIDE.	STORE HOURS MON.-FRI. 7:00 A.M. TO 7:00 P.M. SATURDAY 7:00 A.M. TO 5:00 P.M.	DESCRIPTION	TOTALS
			LABOR AMOUNT PARTS AMOUNT GAS, OIL, LUBE SUBLET AMOUNT MISC. CHARGES TOTAL CHARGES LESS INSURANCE SALES TAX PLEASE PAY THIS AMOUNT	2.20 44.93 27.99 0.00 0.00 72.92 0.00 2.20 75.12

X
 CUSTOMER SIGNATURE

DEALER LIMITED WARRANTY TO CUSTOMERS PURCHASING PARTS AND ACCESSORIES FROM FORD AND LINCOLN DEALERSHIPS

Under the Magnuson-Moss Act (Public Law #93-637), dealers who offer written warranties on retail products selling for more than \$15.00 must meet certain warranty requirements and must inform the purchaser about the warranty.

Coverage Statement

This dealership warrants that Ford parts and accessories found to be defective in factory-supplied material or workmanship will be repaired, replaced, or exchanged as follows:

1. Ford, Lincoln, Mercury Cars & Light Trucks:
 - Repairs prior to 10/1/2013 - 12 months/12,000 miles, whichever comes first from the part or accessory warranty start date.
 - Repairs on or after 10/1/2013 - 24 months/unlimited miles from the part or accessory warranty start date.
2. 650 and Higher Series Trucks
 - 12 months/unlimited miles, from the part or accessory warranty start date.

NOTE: See Unique Warranty Coverages in this section.

The purchaser must return the defective part or accessory to the dealer's place of business during regular business hours for repair or replacement. The purchaser must present the original counter sale receipt or repair order for a dealer-installed part or accessory in order to validate the date and mileage on the vehicle at the date of sale or installation of the original part or accessory. The servicing dealer is required to retain a copy of the original receipt in the customer's service file. If the purchaser is traveling or has moved to a different locality, any authorized Ford Motor Company dealer will fulfill this warranty. THIS WARRANTY DOES NOT COVER PARTS AND ACCESSORIES THAT FAIL DUE TO ABUSE, MISUSE, NEGLIGENCE, ALTERATION, ACCIDENT, RACING, OR THE USE OF NON-FORD PARTS, OR PARTS AND ACCESSORIES INSTALLED IN VEHICLES OTHER THAN THOSE LISTED IN THE COVERAGE STATEMENT INCLUDING OTHER FORD MOTOR COMPANY BRANDS, OR PARTS WHICH ARE REPLACED AS A PART OF NORMAL MAINTENANCE. TO THE EXTENT ALLOWED BY LAW, LOSS OF TIME, INCONVENIENCE, LOSS OF USE OF THE VEHICLE, COMMERCIAL LOSS, AND CONSEQUENTIAL DAMAGES ARE NOT COVERED.

THERE IS NO OTHER EXPRESS WARRANTY OF FORD MOTOR COMPANY-SUPPLIED REPLACEMENT PARTS AND ACCESSORIES. ANY IMPLIED WARRANTY OF MERCHANTABILITY OR FITNESS IS LIMITED TO THE DURATION OF THIS WRITTEN WARRANTY. SOME STATES DO NOT ALLOW THE EXCLUSION OR LIMITATION OF CONSEQUENTIAL OR INCIDENTAL DAMAGES OR LIMITATIONS ON HOW LONG AN IMPLIED WARRANTY LASTS; THEREFORE, THE ABOVE LIMITATIONS AND EXCLUSIONS MAY NOT ALWAYS APPLY. THIS WARRANTY GIVES YOU SPECIFIC LEGAL RIGHTS. YOU MAY ALSO HAVE OTHER RIGHTS WHICH VARY FROM STATE TO STATE.

UNIQUE WARRANTY COVERAGES:

NOTE: The Warranty Start Date for Parts that are:

- Dealer-installed: The date of installation.
- Sold Over-the-Counter:
 - To a retail purchaser: The date of sale.
 - To a fleet, general installer or wholesaler: The date the part or accessory is installed (could be later than the date of sale).
- Battery - See Ford Motor Company's Warranty.
- Bed liner and Cargo Liner (Light Truck) A/ - Lifetime limited coverage to original purchaser. (Contact the warrantor, Parts at 1-888-FORD-0E1 for authorization/replacement Bedliner and CargoLiner supplied at no charge by the manufacturer.)
- Belts and Hoses:
 - Sold before 1-1-92: Limited Warranty for parts, parts allowance and labor.
 - Sold on or after 1-1-92 and before 10-1-13: 12 months/12,000 miles.

ALL OTHER PARTS AND ALL SERVICE PROVIDED AS IS BY DEALERSHIP. EXCEPT FOR THE PARTS AND ACCESSORIES COVERED PURSUANT TO THE EXPRESS LIMITED WARRANTY AS SET FORTH ABOVE, ALL PARTS AND ACCESSORIES ARE SOLD AND ALL REPAIRS AND SERVICES ARE PROVIDED BY OUR DEALERSHIP AS IS. OUR DEALERSHIP DISCLAIMS ALL WARRANTIES, EXPRESS AND IMPLIED, INCLUDING THE IMPLIED WARRANTIES OF MERCHANTABILITY AND FITNESS FOR A PARTICULAR PURPOSE, IN CONNECTION WITH THE SALE OF PARTS AND ACCESSORIES AND/OR SERVICES AND REPAIRS PERFORMED BY OUR DEALERSHIP. THE ENTIRE RISK AS TO THE QUALITY AND PERFORMANCE OF THE VEHICLE AND PARTS AND ACCESSORIES IS WITH THE CUSTOMER AND, IF APPLICABLE, THE MANUFACTURER. IF THE VEHICLE OR ANY INSTALLED PARTS OR ACCESSORIES SHOULD PROVE DEFECTIVE FOLLOWING THEIR PURCHASE, THE CUSTOMER AND POSSIBLY THE MANUFACTURER AND NOT THE DEALERSHIP ASSUME THE ENTIRE COST OF ANY NECESSARY SERVICING OR REPAIR. CUSTOMER SHALL NOT BE ENTITLED TO RECOVER FROM THE DEALERSHIP ANY CONSEQUENTIAL DAMAGES, DAMAGES TO PROPERTY, DAMAGES FOR LOSS OF USE, LOSS OF TIME, LOSS OF PROFITS OR INCOME, OR ANY OTHER INCIDENTAL DAMAGES.

HAZARDOUS WASTE DISPOSAL COSTS: A charge may be assessed to cover costs associated with the handling, management and disposal of toxic waste or hazardous substances under California and Federal Law.

TO OUR SERVICE CUSTOMERS:

1. Our Dealership's usual charges for labor are not based on actual mechanic's time, but are simply our prices for particular jobs.
2. You will be charged no more than the estimated price approved by you. However, if we discover that different or additional repairs are necessary, you will be contacted for your advance approval of a revised estimate.
3. Customer is hereby notified that the vehicle and any of its contents are not insured or protected to the amount of the actual cash value thereof, or otherwise, against loss occasioned by theft, fire or vandalism while the property remains with the Dealership.
4. Customer states no articles of personal property have been left in the vehicle and dealer is not responsible for inspection thereof.
5. The repair of this vehicle and completion date are subject to the availability of labor and parts. The Dealership is not responsible for a unavailability of parts or delays in parts shipment beyond the Dealership's control.
6. Due to the type of service requested some repairs must be sublet.
7. All labor and material's will be paid for in cash unless Dealer agrees to other payment arrangements in advance. Notice as used under PAYMENT TERMS on the front side hereof will be deemed to have been given upon deposit in the United States mail, postage prepaid, of written notification to that effect addressed to the customer at the address given on the front side hereof.
8. If the vehicle described herein is not called for within three (3) days after such notice is given, a daily storage fee will be charged.
9. The Dealership is authorized to deliver the vehicle described herein or any of its contents to any person presenting this receipt.
10. In addition to any and all other legal remedies available I authorize the Dealership to have a lien on the vehicle described herein for all charges for repairs, including labor and parts, storage and/or towing, and to enforce such lien. The Dealership is hereby expressly authorized to sell said vehicle at public auction after giving a twenty (20) day written notice by certified mail to the legal owner, registered owner, and Department of Motor Vehicles of Motor Vehicles of the state. On the sale date, the vehicle shall be sold to the highest cash bidder and the proceeds of sale must be used first to satisfy the lien plus storage costs and costs incident to sale, and the balance shall be forwarded to the legal owner, or if none, to the registered owner, or if the address is unknown, it shall be forwarded to the Department of Motor Vehicles. Said expenses for sale shall also include a reasonable attorney's fees, which may be necessarily incurred.
11. If any such charges remain unpaid for thirty (30) days after such request for payment, the Dealership may also refer such charges to its attorneys for collection and the customer will pay a reasonable attorney's fee.
12. The Power-of-Attorney granted on the front of this Repair Order/Invoice shall be irrevocable and shall remain in effect for so long as there is an outstanding amount due under this Repair Order/Invoice.
13. Remanufactured and refurbished parts that meet manufacturer approved source part requirements may be installed at our discretion. Additional information is available upon request.
14. I authorize the retrieval of on-board data as needed to facilitate vehicle repair, as well as sharing that data with the vehicle manufacturer for diagnostic and research purposes.

Special Notes:

- A/ Labor is covered up to 12 months/12,000 miles, whichever occurs first, if the vehicle is beyond the Bumper to Bumper warranty period -- no parts allowance at any time.
- B/ Same engine components as those covered by the powertrain warranty on 650 and higher series trucks.
- C/ Labor and parts allowance are covered up to 12 months/12,000 miles, whichever occurs first, if the vehicle is beyond the Bumper-to-Bumper warranty period.
- D/ Labor is covered up to 12 months/12,000 miles, whichever occurs first, if the vehicle is beyond the Bumper to Bumper warranty period.

STATEMENT CONCERNING AMENDMENTS TO THE SONG-BEVERLY WARRANTY ACT AS FOLLOWS:

"A buyer of this product in California has the right to have this product serviced or repaired during the warranty period. The warranty period will be extended for the number of whole days that the product has been out of the buyer's hands for warranty repairs. If a defect exists within the warranty period, the warranty will not expire until the defect has been fixed. The warranty period will also be extended if the warranty repairs have not been performed due to delays caused by circumstances beyond the control of the buyer, or if the warranty repairs did not remedy the defect and the buyer notifies the manufacturer or seller of the failure of the repairs within 60 days after they were completed. If, after a reasonable number of attempts, the defect has not been fixed, the buyer may return this product for a replacement or a refund subject, in either case, to deduction of a reasonable charge for usage. This time extension does not affect the protections or remedies the buyer has under other laws."

WARNING

Motor vehicles contain chemicals known to the State of California to cause cancer and birth defects or other reproductive harm. These chemicals are contained in many vehicle components and replacement parts, vehicle fluids, and paints and materials used to maintain vehicles, including, but not limited to, fuel, oil, batteries, brakes, and wheel balancing weights. When you service, clean or maintain your car, you will be exposed to listed chemicals contained in used oil, waste and replacement fluids, fumes, grease, grime, touch-up paint, certain replacement parts, and particulates from component wear. When we service your car, we will return used components to you upon request. Used parts and components contain chemicals known to the State of California to cause cancer and birth defects or other reproductive harm.

To minimize your exposure when servicing, maintaining or cleaning your vehicle: 1) work in a well ventilated area; 2) do not smoke, drink or eat while working; 3) wash your hands when finished or when taking a break; and 4) follow all manufacturer instructions pertaining to proper use and maintenance of motor vehicles and vehicle components.

(Posted in accordance with Proposition 65 in Cal. Health & Safety Code §25249.5 *et seq*)

State of California - Department of Consumer Affairs: NOTICE TO MOTORISTS:

If your vehicle fails Smog Check, new federal law requires you to make necessary repairs to reduce your vehicle's emissions to required levels. If your vehicle is not under warranty and you have spent up to or more than the amount required by law for appropriate emissions-related repairs at a licensed Smog Check repair facility, you may be eligible for a one-time waiver. Repair waivers will NOT be issued for: Vehicles with missing, modified or disconnected emissions control equipment, regardless of the costs to make repairs; Vehicles identified as "Gross Polluters" - vehicles which have much higher emissions than properly maintained vehicles in their class; Vehicles that obtained a repair waiver after January 1, 1995, in their most recent biennial inspection or transfer of ownership. Two consecutive repair waivers will not be issued after January 1, 1995.

If you obtain a smog certificate by means of fraud, you may be subject to a civil penalty of up to \$2500 per day of subject violation. Also, you may be subject to criminal prosecution. For further information, call the Department of Consumer Affairs toll-free at 1-800-952-5210.

BY LAW, YOU MAY CHOOSE ANOTHER LICENSED SMOG CHECK FACILITY TO PERFORM ANY NEEDED REPAIRS OR ADJUSTMENTS WHICH THE SMOG CHECK TEST INDICATES ARE NECESSARY.

TO REORDER CALL 866-266-5591 #365514

DealerCAP Copyright © 2013, ADR, Inc. All rights reserved. California (01-14)

VEHICLE REPORT CARD

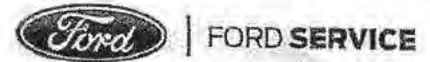

MULTI-POINT INSPECTION AS RECOMMENDED BY FORD MOTOR COMPANY

Date: _____ RO/Tag #: _____ LEGEND May contribute to vehicle efficiency and promote a greener environment

Name: Checked and OK at this time May require future attention Requires immediate attention

Email: _____

Year/Make/Model: _____

VIN #: DD _____ Plate _____

Odometer: 57489 _____ Inspect. Month: _____

Owner Advantage Rewards® #: _____ Service Balance: _____

Ford Extended Service Plan: YES NO

SYNC® MyFord Touch version current: YES NO N/A

SCHEDULED MAINTENANCE ITEMS*			
DUE	SERVICED	DUE	SERVICED
<input checked="" type="checkbox"/> THE WORKS	<input checked="" type="checkbox"/>	<input type="checkbox"/> Engine Air Filter	<input checked="" type="checkbox"/>
<input type="checkbox"/> Oil Change & Filter	<input checked="" type="checkbox"/>	<input type="checkbox"/> Engine Coolant	<input type="checkbox"/>
<input type="checkbox"/> Tire Rotation	<input checked="" type="checkbox"/>	<input type="checkbox"/> Transmission Fluid &/or Filter	<input type="checkbox"/>
<input type="checkbox"/> Multi-Point Inspection	<input checked="" type="checkbox"/>	<input type="checkbox"/> Cabin Air Filter	<input checked="" type="checkbox"/>
<input type="checkbox"/> Fuel Filter	<input type="checkbox"/>	<input type="checkbox"/> Spark Plugs	<input checked="" type="checkbox"/>
K Scheduled Maintenance <input type="checkbox"/>			

*This is only a partial list of vehicle maintenance items and is NOT all-inclusive. Please consult your Owner's Manual or visit FordOwner.com for vehicle-specific maintenance requirements.

FLUID LEVELS				SERVICED
<input checked="" type="checkbox"/> Oil and/or fluid leaks				<input type="checkbox"/>
OK FILL	OK FILL	OK FILL		
<input checked="" type="checkbox"/> Engine Oil	<input checked="" type="checkbox"/> Power Steering	<input checked="" type="checkbox"/> Transmission (if equipped with dipstick)		
<input checked="" type="checkbox"/> Brake Reservoir	<input checked="" type="checkbox"/> Window Washer	<input checked="" type="checkbox"/> Coolant Recovery Reservoir		

WIPER BLADES				SERVICED
<input type="checkbox"/> Test Performed	<input checked="" type="checkbox"/> Front	<input checked="" type="checkbox"/> Rear		<input type="checkbox"/>

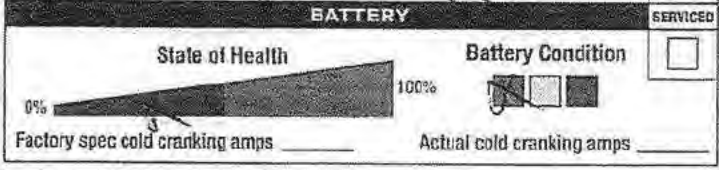

EXTERIOR BODY

Note any existing exterior body damage or defects on diagram

SYSTEMS / COMPONENTS			SERVICED
LIGHTS / WINDSHIELD			
<input checked="" type="checkbox"/>	<input checked="" type="checkbox"/>	Operation of horn, interior lights, exterior lamps, turn signals, hazard and brake lamps	<input type="checkbox"/>
<input checked="" type="checkbox"/>	<input type="checkbox"/>	Windshield for cracks, chips and pitting	<input type="checkbox"/>
BELTS / HOSES / MOUNTS			
<input checked="" type="checkbox"/>	<input type="checkbox"/>	HVAC system and hoses / lines for leaks and/or damage	<input type="checkbox"/>
<input checked="" type="checkbox"/>	<input type="checkbox"/>	Engine Cooling System, radiator, hoses and clamps	<input type="checkbox"/>
<input checked="" type="checkbox"/>	<input type="checkbox"/>	Accessory drive belt(s)	<input type="checkbox"/>
BRAKE SYSTEM			
<input checked="" type="checkbox"/>	<input type="checkbox"/>	Brake system (including lines, hoses, and parking brake)	<input checked="" type="checkbox"/>
STEERING / SUSPENSION			
<input checked="" type="checkbox"/>	<input type="checkbox"/>	Shocks / struts and other suspension components for leaks and/or damage	<input type="checkbox"/>
<input checked="" type="checkbox"/>	<input type="checkbox"/>	Steering, steering linkages and ball joints (visual)	<input type="checkbox"/>
EXHAUST SYSTEM			
<input checked="" type="checkbox"/>	<input type="checkbox"/>	Exhaust system and heat shield (leaks, damage, loose parts)	<input checked="" type="checkbox"/>
TRANSMISSION / DRIVE AXLE			
<input checked="" type="checkbox"/>	<input type="checkbox"/>	Clutch operation (if equipped) <i>Autodrive</i>	<input type="checkbox"/>
<input checked="" type="checkbox"/>	<input type="checkbox"/>	Constant velocity (CV) drive axle boots (if equipped)	<input type="checkbox"/>
<input checked="" type="checkbox"/>	<input type="checkbox"/>	Drive shaft, transmission, u-joint and shift linkage (if equipped) and lubricate (as needed)	<input type="checkbox"/>

TIRE / BRAKE WEAR			
TIRE TREAD	7/32" and greater	4/32" to 6/32"	3/32" and less
BRAKE LINING	Over 5mm or 7/32" (Disc) or Over 2mm or 3/32" (Drum)	3 to 5mm or 4/32" to 7/32" (Disc) or 1.01 to 2mm or 2/32" to 3/32" (Drum)	Less than 3mm or 4/32" (Disc) or 1mm or 2/32" or less (Drum)

TIRE WEAR INDICATES	SERVICED	LEFT FRONT	RIGHT FRONT
<input type="checkbox"/> Alignment check needed	<input type="checkbox"/>	<input checked="" type="checkbox"/> Tire Tread Depth <u>8</u> /32" Tire Age _____	<input checked="" type="checkbox"/> Tire Tread Depth <u>8</u> /32" Tire Age _____
<input type="checkbox"/> Wheel balance needed	<input type="checkbox"/>	<input checked="" type="checkbox"/> Tire Wear Pattern / Damage	<input checked="" type="checkbox"/> Tire Wear Pattern / Damage
<input type="checkbox"/> Brake measurements not taken this service visit	<input type="checkbox"/>	<input checked="" type="checkbox"/> Tire Pressure set to factory-recommended PSI <u>38</u>	<input checked="" type="checkbox"/> Tire Pressure set to factory-recommended PSI <u>38</u>
		<input checked="" type="checkbox"/> Brake Lining <u>7</u> mm /32"	<input checked="" type="checkbox"/> Brake Lining <u>7</u> mm /32"
		LEFT REAR <input checked="" type="checkbox"/>	RIGHT REAR <input checked="" type="checkbox"/>
		<input checked="" type="checkbox"/> Tire Tread Depth <u>8</u> /32" Tire Age _____	<input checked="" type="checkbox"/> Tire Tread Depth <u>8</u> /32" Tire Age _____
		<input checked="" type="checkbox"/> Tire Wear Pattern / Damage	<input checked="" type="checkbox"/> Tire Wear Pattern / Damage
		<input checked="" type="checkbox"/> Tire Pressure set to factory-recommended PSI <u>38</u>	<input checked="" type="checkbox"/> Tire Pressure set to factory-recommended PSI <u>38</u>
		<input checked="" type="checkbox"/> Brake Lining <u>10</u> mm /32"	<input checked="" type="checkbox"/> Brake Lining <u>10</u> mm /32"
		SPARE TIRE <input checked="" type="checkbox"/>	
		<input checked="" type="checkbox"/> Tire Pressure set _____ Tire Age _____	

Comments:
 - Oil Change
 - Tire Rotation
 - Rear back support on driver seat inop
 - Recall

NOTE: Tires should be replaced after 6 years regardless of tread wear, including the spare, even if it has not been used.

FordOwner.com
 One site for all your vehicle needs

Advisor: _____
 Technician: _____

Customer Signature: _____



TOE WEAR
"Feathered" tread wear pattern suggests that tires are turned in or out too far. Signals need for alignment. May be caused by worn shocks/struts.



CAMBER WEAR
Exaggerated wear on inner or outer edge of tire indicates that tires are tilted in or out too far (from vertical). Signals need for alignment. May be caused by worn shocks/struts.

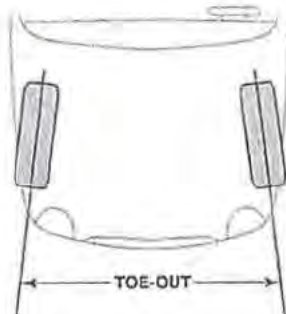

DISC BRAKE

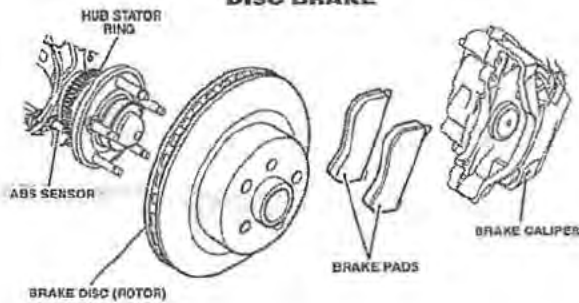

DRUM BRAKE

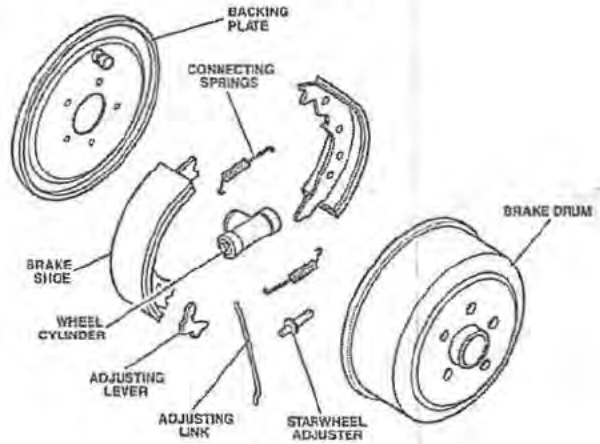

SUSPENSION

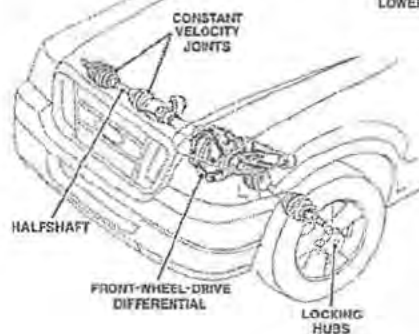
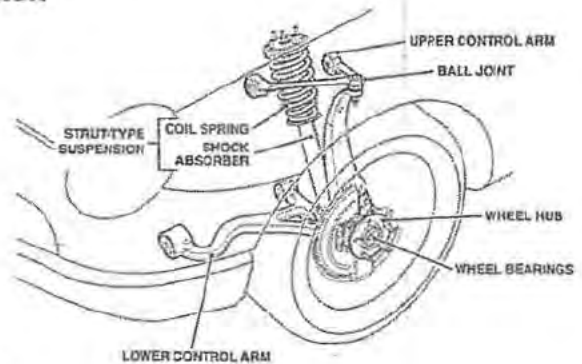
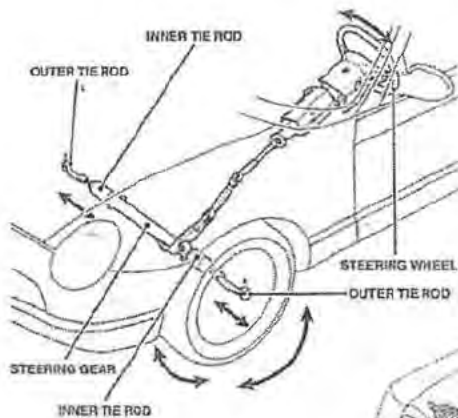



NORM REEVES FORD SUPERSTORE
 NORM REEVES HYUNDAI SUPERSTORE
 NORM REEVES LINCOLN
 18900 Studebaker Road
 Mailing Address P.O. Box 3850 • Cerritos, CA 90703
 (562) 405-3500 • (800) 396-2077



B.
E.

SERVICE HISTORY

DATE	REPAIR ORDER	MILEAGE	ADVISOR	TECHNICIAN	TYPE	OPERATION	OPERATION DESCRIPTION

ALL PARTS WILL BE DISCARDED UNLESS SPECIFIED OTHERWISE <input type="checkbox"/> SAVE	VEHICLE I.D. NO.	YEAR/MAKE/MODEL	PRODUCTION DATE	STOCK NO.	LICENSE NO.	R.O. NO.
	1FM5K7D84 DG	2013 / Ford / Explorer				
	CUSTOMER NO.	SERVICE CONTRACT	DELIVERY DATE	DELIVERY MILES	SELLING DEALER NO.	
	Downey, CA	Magnetic				06/21/17
RESIDENCE PHONE	BUSINESS PHONE	TURBO	MM/C	AIR COND.	P.S.	TRANS
TIME RECEIVED	DATE/TIME PROMISED	PRIORITY	WHEN INQUIRING ABOUT YOUR VEHICLE, PLEASE REFER TO YOUR SERVICE ADVISOR AND R.O. NO.			
7:45 AM			I hereby authorize the repair work herein set forth to be done along with the necessary material and agree that you are not responsible for loss or damage to vehicle or articles left in case of fire, theft or any other cause beyond your control or for any delays caused by unavailability of parts or delays in parts shipments by the supplier or transporter. I hereby grant you and/or your employees permission to operate the vehicle herein described on streets, highways or elsewhere for the purpose of testing and/or inspection. An express mechanic's lien is hereby acknowledged on vehicle to secure the amount of repairs thereto. I authorize the retrieval of on-board data as needed to facilitate vehicle repair, as well as sharing of that data with the manufacturer for diagnostic and research purposes.			
APPOINTMENT	CUSTOMER'S SIGNATURE		ORIGINAL ESTIMATE \$		140.00	
X YES						
NO						

JOB ALL PARTS ARE NEW UNLESS STATED OTHERWISE

C-10 SUSP/STEERING

Customer States the service advanced track message and power assist fault message intermittently will be displayed and you loose power steering please check and advise

2 | 99P
Perform World Class Inspection

3 | TP
Check and Document Tire Pressure

"For Your Convenience"

SERVICE & PARTS DEPARTMENT HOURS

IN ORDER TO SERVE YOU BETTER
 PLEASE CALL FOR A SERVICE APPOINTMENT.
 SERVICE HOURS:
 MONDAY - FRIDAY 7:00 AM - 7:00 PM
 SATURDAY 7:00 AM - 5:00 PM

I hereby designate the individual named below to authorize any additional work not specified or parts not included in the original written estimated price for parts and labor.

Name of Designer:	Phone Number:
E-Mail Address:	Fax Number:
Customer's Signature:	Date:

NOTES:

CHECKS ACCEPTED BUT SUBJECT TO VERIFICATION

HAZARDOUS WASTE: A hazardous waste disposal charge will be added when fluids removed from your vehicle must be disposed of in compliance with federal, state and local government hazardous waste regulations. These fluids are engine oil.

TEARDOWN ESTIMATE: I understand that my vehicle will be reassembled within days of the date shown above if I choose not to authorize the services recommended.

SMOG CHECK
 By law, you may choose another licensed Smog Check facility to perform any needed repairs or adjustments that the Smog Check test indicates are necessary.

STORAGE CHARGE
 Twenty-five dollar per day storage charges may be imposed, if vehicle is not picked up within two business days of notice of completion.

786254

The Reynolds and Reynolds Company ERM/RW/02 CC883616 Q (07/16)

THE PRINTED MAKES NO WARRANTY, EXPRESS OR IMPLIED, AS TO CONTENT OR FITNESS FOR PURPOSE OF THIS FORM. CONSULT YOUR OWN LEGAL COUNSEL.

With regards to Warranty, The Dealer (NORM REEVES) is acting as an agent for Ford Motor Company and Hyundai of America.

Ford Motor Co., which hereinafter will be called the Company, warrants to the Dealer, that the Company will replace without charge any part or accessory found to be defective in material or workmanship that was installed by the Dealer for a period of 12,000 miles or service or 12 months from the date of installation, whichever comes first. In addition, the Company will reimburse the Dealer for labor costs to repair or replace such defective part as set forth in the Warranty and Policy manual.

The customer must return said vehicle to the Dealer during regular business hours for repair or replacement of the defective part or accessory. The customer must also furnish the Dealer with the original's original copy of said repair.

This warranty does not cover parts or accessories that fail due to abuse, misuse, neglect, alteration or accident or which have been improperly lubricated or repaired, or used in applications for which they were either not designed or not approved by the Company, or which fail due to the use of low-grade fuel, improper selection of heat range or misapplication, or failure caused by non-Ford parts. Loss of time, inconvenience, loss of use of the vehicle, commercial loss, or consequential damages are not covered.

There is no other express warranty on company supplied replacement parts and accessories, except such obligation that the Company may have assumed in its Warranty and Policy manual or other separate written instrument.

Any implied warranty of merchantability or fitness is limited to the 12-mos./12,000 miles duration of this written warranty.

Authorized Genuine Hyundai Replacement Parts and Accessories are covered by the Limited Warranty.

For full details on coverage, please see the Hyundai Warranty and Maintenance booklet.

*Excluding wear items.

WARRANTY SERVICE NOTICE (AS REQUIRED BY THE SONG BEVERLY ACT)

"A buyer of this product in California has the right to have this product serviced or repaired during the warranty period. The warranty period will be extended for the number of whole days that the product has been out of the buyer's hands for warranty repairs. If a defect exists within the warranty period, the warranty will not expire until the defect has been fixed. The warranty period will also be extended if the warranty repairs have not been performed due to delays caused by circumstances beyond the control of the buyer, or if the warranty repairs do not remedy the defect and the buyer notifies the manufacturer or seller of the failure of the repairs within 60 days after they were completed. If, after a reasonable number of attempts, the defect has not been fixed, the buyer may return this product for a replacement or a refund subject, in either case, to deduction of a reasonable charge for usage. This time extension does not affect the protections or remedies the buyer has under other laws."

ADDITIONAL TERMS & CONDITIONS

1. Our Dealership's usual charges for labor are not based on actual mechanic's time, but are simply our prices for particular jobs.
2. You will be charged no more than the estimated price approved by you. However, if we discover that different or additional repairs are necessary, you will be contacted for your advance approval of a revised estimate.
3. Customer is hereby notified that the vehicle and any of its contents are not insured or protected to the amount of the actual cash value thereof, or otherwise, against loss occasioned by theft, fire or vandalism while the property remains with the Dealership.
4. Customer states no articles of personal property have been left in the vehicle and dealer is not responsible for inspection thereof.
5. The repair of this vehicle and completion date are subject to the availability of labor and parts. The Dealership is not responsible for unavailability of parts or delays in parts shipment beyond the Dealership's control.
6. Due to the type of service requested some repairs must be subtle.
7. All labor and materials will be paid for in cash unless Dealer agrees to other payment arrangements in advance. Notice as used under PAYMENT TERMS on the front side hereof will be deemed to have been given upon deposit in the United States mail, postage prepaid, of written notification to that effect addressed to the customer at the address given on the front side hereof.
8. If the vehicle described herein is not called for within three (3) days after such notice is given, a daily storage fee will be charged, \$50.00 per day.
9. The Dealership is authorized to deliver the vehicle described herein or any of its contents to any person presenting this receipt.

DISCLAIMER OF WARRANTIES: NORM REEVES hereby expressly disclaims all warranties, either expressed or implied, including any implied warranty of merchantability or fitness for a particular purpose, and NORM REEVES neither assumes nor authorizes any other person to assume for it any liability in connection with the sale of said products. The only warranties which apply are those of the manufacturer.

NO PARTS WARRANTY ON MOTORSPORT PERFORMANCE EQUIPMENT

Competition parts are sold "as is" without any warranty whatsoever. Implied warranties including warranties of merchantability or fitness for a particular purpose, are excluded. The entire risk as to quality and performance of such parts is with the buyer. Should such parts prove defective following their purchase, the buyer and not the manufacturer, distributor or retailer, assumes the entire cost of all necessary servicing or repairs. Ford Motor Company vehicle and parts warranties are voided if the vehicle or part is used for competition or if they fail as a result of modification.

WARNING: MOTORSPORT PERFORMANCE EQUIPMENT RESTRICTED USE

This part has been designed and is intended for off-highway application only. Installation on a vehicle intended for use on public roads may violate U.S., Canadian, state or provincial laws and regulations including those relating to emission requirements and motor vehicle safety standards. (NOTE: In California this part may legally be used only on racing vehicle which will never be operated on public roads.) In addition, installation of this part may adversely affect the warranty coverage on your vehicle.

ADJUSTMENT WARRANTY

NORM REEVES WARRANTS ALL ADJUSTMENT WARRANTY PERFORMED TO YOUR MOTOR VEHICLE AS SET FORTH ON THE REVERSE SIDE FOR A PERIOD OF ONLY 6 MOS. OR 6,000 MILES, WHICHEVER OCCURS FIRST. THIS TIME PERIOD AND MILEAGE SHALL COMMENCE FROM DATE ADJUSTMENT HAS BEEN COMPLETED.

LIMITED WARRANTY - LABOR

NORM REEVES WARRANTS ALL LABOR PERFORMED TO YOUR MOTOR VEHICLE AS SET FORTH ON THE REVERSE SIDE FOR A PERIOD OF ONLY 12 MONTHS OR 12,000 MILES, WHICHEVER OCCURS FIRST. THIS TIME PERIOD AND MILEAGE DETERMINATION SHALL COMMENCE FROM THE DATE THE LABOR HAS BEEN COMPLETED.

ALL WARRANTY WORK MUST BE PERFORMED BY NORM REEVES AT ITS PLACE OF BUSINESS LOCATED ON REVERSE SIDE. TO OBTAIN ANY WARRANTY WORK YOU MUST BRING YOUR MOTOR VEHICLE TO THIS ADDRESS PRIOR TO THE EXPIRATION OF YOUR WARRANTY.

THIS WARRANTY IS EFFECTIVE ONLY IF THE MOTOR VEHICLE IS OPERATED IN A NORMAL AND ORDINARY MANNER. THIS WARRANTY IS NOT TRANSFERABLE AND MAY BE ENFORCED ONLY BY YOU SO LONG AS YOU OWN THE MOTOR VEHICLE TO WHICH THIS LABOR HAS BEEN PERFORMED. ANY IMPLIED WARRANTIES YOU MAY BE ENTITLED TO BY LAW SHALL BE LIMITED IN DURATION TO THE DURATION OF THE ABOVE DESCRIBED EXPRESS WARRANTY.

THIS WARRANTY DOES NOT COVER PARTS OR ACCESSORIES THAT FAIL DUE TO ABUSE, MISUSE, NEGLIGENCE, ALTERATION OR ACCIDENT OR WHICH HAVE BEEN IMPROPERLY LUBRICATED OR REPAIRED, OR USED IN APPLICATIONS FOR WHICH THEY WERE EITHER NOT DESIGNED OR NOT APPROVED BY THE COMPANY, OR ARE CLEANED, ADJUSTED OR REPLACED AS A PART OF NORMAL MAINTENANCE, OR SPARK PLUGS THAT ARE OIL FOULED, LEAD FOULED OR WHICH FAIL DUE TO THE USE OF LOW-GRADE FUEL, IMPROPER SELECTION OF HEAT RANGE OR MISAPPLICATION, OR FAILURES CAUSED BY NON-FORD PARTS.

TO THE EXTENT ALLOWED BY LAW, LOSS OF TIME, INCONVENIENCE, LOSS OF USE OF THE VEHICLE, COMMERCIAL LOSS, OR CONSEQUENTIAL DAMAGES ARE NOT COVERED.

THERE IS NO OTHER EXPRESS WARRANTY ON FORD MOTOR COMPANY SUPPLIED REPLACEMENT PARTS AND ACCESSORIES, EXCEPT SUCH OBLIGATION AS FORD MAY HAVE ASSUMED IN ITS WARRANTY AND POLICY MANUAL OR OTHER SEPARATE WRITTEN INSTRUMENT.

ANY IMPLIED WARRANTY OF MERCHANTABILITY OR FITNESS IS LIMITED TO THE 12 MONTH/12,000 MILE DURATION OF THIS WRITTEN WARRANTY.

SOME STATES DO NOT ALLOW THE EXCLUSION OR LIMITATION OF CONSEQUENTIAL OR INCIDENTAL DAMAGES OR LIMITATION ON HOW LONG AN IMPLIED WARRANTY LASTS. SO THE ABOVE LIMITATION AND EXCLUSIONS MAY NOT APPLY TO YOU.

IMPORTANT NOTICE

"By law, you may choose another licensed Smog Check Facility to perform any needed repairs or adjustments that the Smog Check test indicates are necessary."

REMOVE ALL PERSONAL ARTICLES AND VALUABLES FROM YOUR VEHICLE.

WE ARE NOT RESPONSIBLE FOR LOSS OR DAMAGE TO YOUR VEHICLE OR TO PERSONAL ARTICLES LEFT IN YOUR VEHICLE.

WARNING:

Motor Vehicles contain chemicals known to the State of California to cause cancer and birth defects or other reproductive harm. These chemicals are contained in many vehicle components and replacement parts, vehicle fluids, and paints and materials used to maintain vehicles, including, but not limited to, fuel, oil, batteries, brakes, and wheel balancing weights. When you service, clean or maintain your car, you will be exposed to listed chemicals contained in used oil, waste and replacement fluids, fumes, grease, grime, touch-up paint, certain replacement parts, and particulates from component wear. When we service your car, we will return used components to you upon request. Used parts and components contain chemicals known to the State of California to cause cancer and birth defects or other reproductive harm.

To minimize your exposure when servicing, maintaining or cleaning your vehicle: 1) work in a well ventilated area; 2) do not smoke, drink or eat while working; 3) wash your hands when finished or when taking a break; and 4) follow all manufacturer instructions pertaining to proper use and maintenance of motor vehicles and vehicle components.

(Posted in accordance with Proposition 65 in Cal. Health & Safety Code §25249.5 et seq.) For further information about Proposition 65: <http://www.oehha.org/prop65.htm>.



AutoNation



AutoNation Ford Tustin

#2 AUTO CENTER DR, TUSTIN, CA 92782 (714) 832-3300

ALL CLAIMS AND RETURNED GOODS MUST BE ACCOMPANIED BY THIS BILL.
15% HANDLING CHARGE ON ALL RETURNS.
PARTS NOT RETURNABLE AFTER 10 DAYS.
NO CASH REFUNDS.

IMPORTANT WARRANTY INFORMATION Please Read and Sign Before Purchase

You should look to the material provided by the manufacturer of the automotive part(s) or accessory(ies) described on reverse side to determine your warranty rights, if any. The manufacturer's warranty, if any, represents a contract between you and the manufacturer only and AutoNation Ford Tustin assumes no responsibility or liability under it. Any service provided by AutoNation Ford Tustin under such warranty is performed only as agent for the manufacturer.

DATE ENTERED 04 AUG 16	YOUR ORDER NO. [REDACTED]	DATE SHIPPED 04 AUG 16	INVOICE DATE	INVOICE NUMBER [REDACTED]	16:13:10
---------------------------	------------------------------	---------------------------	--------------	------------------------------	----------

S
O
L
D

T
O

ACCOUNT NO [REDACTED]
CASH WHOLESALE

S
H
I
P

T
O

PAGE 1 OF 1

SHIP VIA	SLSM.	B/L NO.	TERMS Cash Wholesale	F.O.B. POINT TUSTIN, CA												
1	1	0	261	17.00												
1	1	0	SR	17.00												
<table border="1"> <thead> <tr> <th>DESCRIPTION</th> <th>LIST</th> <th>NET</th> <th>AMOUNT</th> </tr> </thead> <tbody> <tr> <td>261 FILTER - O</td> <td>35.72</td> <td>17.00</td> <td>17.00</td> </tr> <tr> <td>SR WORK LIGHT</td> <td>18.95</td> <td>17.00</td> <td>17.00</td> </tr> </tbody> </table>					DESCRIPTION	LIST	NET	AMOUNT	261 FILTER - O	35.72	17.00	17.00	SR WORK LIGHT	18.95	17.00	17.00
DESCRIPTION	LIST	NET	AMOUNT													
261 FILTER - O	35.72	17.00	17.00													
SR WORK LIGHT	18.95	17.00	17.00													
<p>PAID</p> <p>VMC ✓ AMEX</p> <p>DISC ELEC CK</p> <p>ANG 04 2016</p> <p>CK# CASH</p>																
<p>Ford Motor Co. Parts Warranty 12 months or 12,000 miles, whichever comes first.</p> <p>7000 Transmissions</p> <p>6000 Engines, 36 months or 36,000 miles, whichever comes first.</p>																
<p>PARTS DEPT. HOURS</p> <p>MON. - FRI.</p> <p>7:00 AM - 7:00 PM</p> <p>SAT.</p> <p>8:00 AM - 5:00 PM</p>																
*****			PARTS	34.00												
*****			SUBLET													
*****			FREIGHT	0.00												
*****			SALES TAX	2.72												
*** ORDERS CAN NOW BE PLACED 7x24 ***			TOTAL	\$36.72												
CUSTOMER'S SIGNATURE																
X																

DEALER LIMITED WARRANTY TO CUSTOMERS PURCHASING PARTS AND ACCESSORIES FROM FORD AND LINCOLN DEALERSHIPS

Under the Magnuson-Moss Act (Public Law #93-637), dealers who offer written warranties on retail products calling for more than \$15.00 must meet certain warranty requirements and must inform the purchaser about the warranty.

Coverage Statement

This dealership warrants that Ford parts and accessories found to be defective in factory-supplied material (i.e., workmanship) will be repaired, replaced, or exchanged as follows:

- 1. Ford, Lincoln, Mercury Cars & Light Trucks:
 - Repairs prior to 10/1/2013 - 12 months/12,000 miles, whichever comes first from the part or accessory warranty start date.
 - Repairs on or after 10/1/2013 - 24 months/unlimited miles from the part or accessory warranty start date.
- 2. 650 and Higher Series Trucks
 - 12 months/unlimited miles from the part or accessory warranty start date.

NOTE: See Unique Warranty Coverages in this section.

The purchaser must return the defective part or accessory to the dealer's place of business during regular business hours for repair or replacement. The purchaser must present the original cylinder, safe receipt or repair order for a dealer-installed part or accessory in order to validate the date and mileage on the vehicle at the date of sale or installation of the original part or accessory. The servicing dealer is required to retain a copy of the original receipt in the customer's service file. If the purchaser is traveling or has moved to a different locality, any authorized Ford Motor Company dealer will fulfill the warranty. THIS WARRANTY DOES NOT COVER PARTS AND ACCESSORIES THAT FAIL DUE TO ABUSE, MISUSE, NEGLIGENCE, ALTERATION, ACCIDENT, RACING, OR THE USE OF NON-FORD PARTS OR PARTS AND ACCESSORIES INSTALLED IN VEHICLES OTHER THAN THOSE LISTED IN THE COVERAGE STATEMENT INCLUDING OTHER FORD MOTOR COMPANY BRANDS, OR PARTS WHICH ARE REPLACED AS A PART OF NORMAL MAINTENANCE. TO THE EXTENT ALLOWED BY LAW, LOSS OF TIME, INCONVENIENCE, LOSS OF USE OF THE VEHICLE, COMMERCIAL LOSS, AND CONSEQUENTIAL DAMAGES ARE NOT COVERED.

THIS IS NO OTHER EXPRESS WARRANTY OF FORD MOTOR COMPANY SUPPLIED REPLACEMENT PARTS AND ACCESSORIES. ANY IMPLIED WARRANTY OF MERCHANTABILITY OR FITNESS IS LIMITED TO THE DURATION OF THIS WRITTEN WARRANTY. SOME STATES DO NOT ALLOW THE EXCLUSION OR LIMITATION OF CONSEQUENTIAL OR INCIDENTAL DAMAGES ON LIMITATIONS ON HOW LONG AN IMPLIED WARRANTY LASTS. THEREFORE, THE ABOVE LIMITATIONS AND EXCLUSIONS MAY NOT ALWAYS APPLY. THIS WARRANTY GIVES YOU SPECIFIC LEGAL RIGHTS YOU MAY ALSO HAVE OTHER RIGHTS WHICH VARY FROM STATE TO STATE.

UNIQUE WARRANTY COVERAGES:

NOTE: The Warranty Start Date for Parts that are:

- Dealer-installed: The date of installation.
- Sold from the Customer:
 - To a retail purchaser: The date of sale.
 - To a fleet, general installer or wholesaler: The date the part or accessory is installed (could be later than the date of sale).
- Battery - See Ford Motor Company's Warranty.
- Bed liner and Cargo Liner (Light Truck) A2 - Lifetime limited coverage to original purchaser. (Contact the warrantor, Penda at 1-888-FORD-0E1 for authorized replacement Bedliner and CargoLiner supplied at no charge by the manufacturer.)
- Belts and Hoses:
 - Sold before 1-1-92: 12 month Warranty for parts, parts allowance and labor.
 - Sold on or after 1-1-92 and before 10-1-93: 12 months/12,000 miles.

- **Bumper-MasterGuard A2:** Contact the warrantor, Master Guard at 1-800-441-7554 for information to reduce the bumper and for a replacement bumper supplied by Master Guard via postage. Additional information on Master Guard Bumpers can be found in the Accessories Showcase.
- **Diesel Engines - Ford New Holland:**
 - 6.6L and 7.8L Engine Components: 12 months/unlimited miles.
 - 6.6L and 7.8L Ford remanufactured Engines: 12 months/unlimited miles.
- **Lift Supports - Motorcraft C/ - Lifetime Limited Warranty to original purchaser. (Not to be used under the New Vehicle Limited Warranty.)**
- **Motorcraft Parts - See Ford Motor Company's Warranty.**
- **Sheet Metal - Lifetime limited guarantee (as long as original purchaser owns the vehicle) against rust perforation (includes parts, parts allowance, and labor).**
- **Shock Absorbers and Struts - Motorcraft D/:**
 - For shock absorbers or struts sold on or after October 1, 1997:
 - Private Cars and Light Trucks: Lifetime Limited Warranty to original purchaser.
 - Other than Private Cars and Light Trucks: 24 months or 24,000 miles, whichever occurs first.
 - For shock absorbers or struts sold before October 1, 1997:
 - AA, AS, AT, AW, AX Series:
 - Private Cars and Light Trucks: Lifetime Limited Warranty to original purchaser.
 - Other than Private Cars and Light Trucks: 24 months/24,000 miles, whichever comes first.
 - AA Series (Cardan's and Assemblies): 12 months/24,000 miles, whichever occurs first.
 - AX Series: 24 months/24,000 miles, whichever occurs first.
- **Spark Plug Wiring Set (Complete Set) Z/:**
 - Normal Service: Lifetime Limited Warranty to original purchaser.
 - Street Service (e.g., Police/Taxi): 12 months or 12,000 miles.
- **Tires - No Service Part Warranty Coverage.**
- **Vehicle Security System (Ford Alarm - Dealer Installed) A2:** Lifetime Limited Warranty on parts. Contact dealer at 800-FORD-KEY (3673-539) for parts replacement.
- **Walker Exhaust SDS program B/:** Effective November 1, 1993, a Lifetime Limited Warranty is provided on all Walker replacement mufflers against rust through, blowouts and defects in material and workmanship for as long as the original purchaser of the muffler owns the vehicle. A 12 month/12,000 mile warranty is also provided on muffler system replacement pipes, accessories and catalytic converters.

Special Notes:

- A/ Labor is covered up to 12 months/12,000 miles, whichever occurs first, if the vehicle is beyond the Bumper to Bumper warranty period - no parts allowance at any time.
- B/ Same engine components as those covered by the powertrain warranty on 650 and higher series trucks.
- C/ Labor and parts allowance are covered up to 12 months/12,000 miles, whichever occurs first, if the vehicle is beyond the Bumper-to-Bumper warranty period.
- D/ Labor is covered up to 12 months/12,000 miles, whichever occurs first, if the vehicle is beyond the Bumper to Bumper warranty period.

ALL OTHER PARTS AND ALL SERVICE PROVIDED AS IS BY DEALERSHIP. EXCEPT FOR THE PARTS AND ACCESSORIES COVERED PURSUANT TO THE EXPRESS LIMITED WARRANTY AS SET FORTH ABOVE, ALL PARTS AND ACCESSORIES ARE SOLD AND ALL REPAIRS AND SERVICES ARE PROVIDED BY OUR DEALERSHIP AS IS. OUR DEALERSHIP DISCLAIMS ALL WARRANTIES, EXPRESS AND IMPLIED, INCLUDING THE IMPLIED WARRANTIES OF MERCHANTABILITY AND FITNESS FOR A PARTICULAR PURPOSE, IN CONNECTION WITH THE SALE OF PARTS AND ACCESSORIES AND/OR SERVICES AND REPAIRS PERFORMED BY OUR DEALERSHIP. THE ENTIRE RISK AS TO THE QUALITY AND PERFORMANCE OF THE VEHICLE AND PARTS AND ACCESSORIES IS WITH THE CUSTOMER AND, IF APPLICABLE, THE MANUFACTURER. IF THE VEHICLE OR ANY INSTALLED PARTS OR ACCESSORIES SHOULD PROVE DEFECTIVE FOLLOWING THEIR PURCHASE, THE CUSTOMER AND POSSIBLY THE MANUFACTURER AND NOT THE DEALERSHIP ASSUME THE ENTIRE COST OF ANY NECESSARY SERVICING OR REPAIR. CUSTOMER SHALL NOT BE ENTITLED TO RECOVER FROM THE DEALERSHIP ANY CONSEQUENTIAL DAMAGES, DAMAGES TO PROPERTY, DAMAGES FOR LOSS OF USE, LOSS OF TIME, LOSS OF PROFITS OR INCOME, OR ANY OTHER INCIDENTAL DAMAGES.

HAZARDOUS WASTE DISPOSAL COSTS: A charge may be assessed to cover costs associated with the handling, management and disposal of toxic waste or hazardous substances under California and Federal Law.

TO OUR SERVICE CUSTOMERS:

1. Our Dealership's usual charges for labor are not based on school mechanic's time, but are simply our prices for particular jobs.
2. You will be charged no more than the estimated price approved by you. However, if we discover that different or additional repairs are necessary, you will be contacted for your advance approval of a revised estimate.
3. Customer is hereby notified that the vehicle and any of its contents are not insured or protected to the amount of the actual cash value thereof, or otherwise, against loss occasioned by theft, fire or vandalism while the property remains with the Dealership.
4. Customer states no articles of personal property have been left in the vehicle and dealer is not responsible for inspection thereof.
5. The repair of this vehicle and completion date are subject to the availability of labor and parts. The Dealership is not responsible for unavailability of parts or delays in parts shipment beyond the Dealership's control.
6. Due to the type of service requested some repairs must be shifted.
7. All labor and materials will be paid for in cash unless Dealer agrees to other payment arrangements in advance. Notice as used under PAYMENT TERMS on the front side hereof will be deemed to have been given upon deposit in the United States mail, postage prepaid, by written notification to that effect addressed to the customer at the address given on the front side hereof.
8. If the vehicle described herein is not called for within three (3) days after such notice is given, a daily storage fee will be charged.
9. The Dealership is authorized to deliver the vehicle described herein or any of its contents to any person presenting this receipt.
10. In addition to any and all other legal remedies available, I authorize the Dealership to have a lien on the vehicle described herein for all charges for repairs, including labor and parts, storage and/or towing, and to enforce such lien. The Dealership is hereby expressly authorized to sell said vehicle at public auction after giving a twenty (20) day written notice by certified mail to the legal owner, registered owner, and Department of Motor Vehicles of intent to do so. On the sale date, the vehicle shall be sold to the highest cash bidder and the proceeds of sale must be used first to satisfy the lien. The storage costs and costs incident to sale, and the balance shall be forwarded to the legal owner, or if none, to the registered owner, or if the address is unknown, I shall be forwarded to the Department of Motor Vehicles. Said expenses for sale shall also include a reasonable attorney's fees, which may be necessarily incurred.
11. If any such charges remain unpaid for thirty (30) days after such request for payment, the Dealership may also later charge to its attorney for collection and the customer will pay a reasonable attorney's fee.
12. The express-attorney grants on the front of this Dealer Order may be irrevocable and shall remain in effect for so long as there is an outstanding amount due under this Repair Order/Invoice.
13. Remanufactured and refurbished parts from most manufacturer approved sources may be installed at our discretion. Additional information is available upon request.
14. I authorize the retrieval of on-board data as needed to facilitate vehicle repair, as well as sharing that data with the vehicle manufacturer for diagnostic and research purposes.

STATEMENT CONCERNING AMENDMENTS TO THE SONG-BEVERLY WARRANTY ACT AS FOLLOWS:

"A buyer of this product in California has the right to have this product serviced or repaired during the warranty period. The warranty period will be extended for the number of whole days that the product has been out of the buyer's hands for warranty repairs. If a defect exists within the warranty period, the warranty will not expire until the defect has been fixed. The warranty period will also be extended if the warranty repairs have not been performed due to delays caused by circumstances beyond the control of the buyer, or if the warranty repairs did not remedy the defect and the buyer notifies the manufacturer or seller of the failure of the repairs within 60 days after they were completed. If, after a reasonable number of attempts, the defect has not been fixed, the buyer may return this product for a replacement or a refund subject, in either case, to deduction of a reasonable charge for usage. This time extension does not affect the protections or remedies the buyer has under other laws."

WARNING

Motor vehicles contain chemicals known to the State of California to cause cancer and birth defects or other reproductive harm. These chemicals are contained in many vehicle components and replacement parts, vehicle fluids, and paints and materials used to maintain vehicles, including, but not limited to, fuel, oil, batteries, brakes, and wheel balancing weights. When you service, clean or maintain your car, you will be exposed to listed chemicals contained in used oil, waste and replacement fluids, fumes, grease, grime, touch-up paint, certain replacement parts, and particulates from component wear. When we service your car, we will return used components to you upon request. Used parts and components contain chemicals known to the State of California to cause cancer and birth defects or other reproductive harm.

To minimize your exposure when servicing, maintaining or cleaning your vehicle: 1) work in a well ventilated area; 2) do not smoke, drink or eat while working; 3) wash your hands when finished or when taking a break; and 4) follow all manufacturer instructions pertaining to proper use and maintenance of motor vehicles and vehicle components.

(Posted in accordance with Proposition 65 in Cal. Health & Safety Code §25249.5 et seq)

State of California - Department of Consumer Affairs: NOTICE TO MOTORISTS:

If your vehicle fails Smog Check, new federal law requires you to make necessary repairs to reduce your vehicle's emissions to required levels. If your vehicle is not under warranty and you have spent up to or more than the amount required by law for appropriate emissions-related repairs at a licensed Smog Check repair facility, you may be eligible for a one-time waiver. Repair waivers will NOT be issued for: Vehicles with missing, modified or disconnected emissions control equipment, regardless of the costs to make repairs; Vehicles identified as "Gross Polluters" - vehicles which have much higher emissions than properly maintained vehicles in their class; Vehicles that obtained a repair waiver after January 1, 1995, in their most recent biennial inspection or transfer of ownership; Two consecutive repair waivers will not be issued after January 1, 1995.

If you obtain a smog certificate by means of fraud, you may be subject to a civil penalty of up to \$2500 per day of subject violation. Also, you may be subject to criminal prosecution. For further information, call the Department of Consumer Affairs toll-free at 1-800-952-5210.

BY LAW, YOU MAY CHOOSE ANOTHER LICENSED SMOG CHECK FACILITY TO PERFORM ANY NEEDED REPAIRS OR ADJUSTMENTS WHICH THE SMOG CHECK TEST INDICATES ARE NECESSARY.



NORM REEVES
LINCOLN
CERRITOS AUTO SQUARE

NORM REEVES FORD SUPERSTORE
NORM REEVES HYUNDAI SUPERSTORE
NORM REEVES LINCOLN
18900 Studebaker Road
Mailing Address P.O. Box 3850 • Cerritos, CA 90703
(562) 405-3500 • (800) 396-2077



BAR
EPA

CUSTOMER NO.	ADVISOR	TAG NO.	INVOICE DATE	INVOICE NO.
[REDACTED]	John Rempt	[REDACTED]	06/23/17	[REDACTED]
[REDACTED]	LICENS. STATE	MILEAGE	DELIVERY DATE	DELIVERY MILES
[REDACTED]	[REDACTED]	74254	Magnetic	
Downey, CA [REDACTED]	YEAR / MAKE / MODEL	VEHICLE ID. NO.	SELLING DEALER NO.	PRODUCTION DATE
	2013 / Ford / Explorer	1FM5K7D84DC [REDACTED]		
	F.T.E. NO.	P.O. NO.	R.O. DATE	
			06/21/17	
RESIDENCE PHONE	BUSINESS PHONE	COMMENTS		

Labor and Parts

J# 1 10 SUSP / STEERING Tech(s) 1161 140.00
Customer States the service advanced track message and power assist fault message intermittently will be displayed and you loose power steering please check and advise

BCE DIAG RETRIEVED DTC C1B00:64 CONCERN NOT A HARD FAULT AT THIS TIME.REPROGRAM PSCM FOR DTC C1B00,CLEARED CODES ROAD TEST VEHICLE RETEST OK

J# 2 99P Tech(s) Internal Work
Perform World Class Inspection

Performed World Class Inspection

J# 3 TP Tech(s) 1161 Internal Work
Check and Document Tire Pressure Inspection

Set Tire Pressure to: RF 35 RR 35 LF 35 LR35

J# 3 Total Parts Internal Work
Total Labor 140.00
Total Parts 0.00
Total Sublet 0.00
Misc. Chrgs 0.00
Car Rental 0.00
Freight 0.00
Deductible 0.00
Special Tax 0.00
Haz Mat Chrg 0.00
Sales Tax 0.00

Total Invoice \$ 140.00

I acknowledge receipt of the above listed vehicle:

Signature _____ Date _____

I acknowledge notice of an oral approval of an increase in the original estimate price

Signature _____

Thank You
for servicing your vehicle at
NORM REEVES We truly
appreciate your business.

Our goal is to Meet Your Expectations. If for any reason you feel that we did not meet your expectations please let us know. Contact your service manager and let him know your concern.

SERVICE HOURS
MONDAY - FRIDAY 7:00 AM - 7:00 PM
SATURDAY 8:00 AM - 5:00 PM

The Reynolds and Reynolds Company #REYNOLDS GO514561 Q (11/15)

THE PRINTER MAKES NO WARRANTY, EXPRESS OR IMPLIED, AS TO CONTENT OR FITNESS FOR PURPOSE OF THIS FORM. CONSULT YOUR OWN LEGAL COUNSEL.

With regards to Warranty, The Dealer (NORM REEVES) is acting as an agent for Ford Motor Company and Hyundai of America.

Ford Motor Co., which hereinafter will be called the Company, warrants to the Dealer, that the Company will replace without charge any part or accessory found to be defective in material or workmanship that was installed by the Dealer for a period of 12,000 miles of service or 12 months from the date of installation, whichever comes first. In addition, the Company will reimburse the Dealer for labor costs to repair or replace such defective part as set forth in the Warranty and Policy manual.

The customer must return said vehicle to the Dealer during regular business hours for repair or replacement of the defective part or accessory. The customer must also furnish the Dealer with the customer's original copy of said repair.

This warranty does not cover parts or accessories that fail due to abuse, misuse, neglect, alteration or accident or which have been improperly lubricated or repaired, or used in applications for which they were either not designed or not approved by the Company, or which fail due to the use of low-grade fuel, improper selection of heat range or misapplication, or failure caused by non-Ford parts. Loss of time, inconvenience, loss of use of the vehicle, commercial loss, or consequential damages are not covered.

There is no other express warranty on company supplied replacement parts and accessories, except such obligation that the Company may have assumed in its Warranty and Policy manual or other separate written instrument.

Any implied warranty of merchantability or fitness is limited to the 12-mos./12,000 miles duration of this written warranty.

Authorized Genuine Hyundai Replacement Parts and Accessories are covered by the Limited Warranty*.

For full details on coverage, please see the Hyundai Warranty and Maintenance booklet.

*Excluding wear items.

WARRANTY SERVICE NOTICE (AS REQUIRED BY THE SONG BEVERLY ACT)

"A buyer of this product in California has the right to have this product serviced or repaired during the warranty period. The warranty period will be extended for the number of whole days that the product has been out of the buyer's hands for warranty repairs. If a defect exists within the warranty period, the warranty will not expire until the defect has been fixed. The warranty period will also be extended if the warranty repairs have not been performed due to delays caused by circumstances beyond the control of the buyer, or if the warranty repairs did not remedy the defect and the buyer notifies the manufacturer or seller of the failure of the repairs within 60 days after they were completed. If, after a reasonable number of attempts, the defect has not been fixed, the buyer may return this product for a replacement or a refund subject, in either case, to deduction of a reasonable charge for usage. This time extension does not affect the protections or remedies the buyer has under other laws."

ADDITIONAL TERMS & CONDITIONS

1. Our Dealership's usual charges for labor are not based on actual mechanic's time, but are simply our prices for particular jobs.
2. You will be charged no more than the estimated price approved by you. However, if we discover that different or additional repairs are necessary, you will be contacted for your advance approval of a revised estimate.
3. Customer is hereby notified that the vehicle and any of its contents are not insured or protected to the amount of the actual cash value thereof, or otherwise, against loss occasioned by theft, fire or vandalism while the property remains with the Dealership.
4. Customer states no articles of personal property have been left in the vehicle and dealer is not responsible for inspection thereof.
5. The repair of this vehicle and completion date are subject to the availability of labor and parts. The Dealership is not responsible for unavailability of parts or delays in parts shipment beyond the Dealership's control.
6. Due to the type of service requested some repairs must be sublet.
7. All labor and materials will be paid for in cash unless Dealer agrees to other payment arrangements in advance. Notice as used under PAYMENT TERMS on the front side hereof will be deemed to have been given upon deposit in the United States mail, postage prepaid, of written notification to that effect addressed to the customer at the address given on the front side hereof.
8. If the vehicle described herein is not called for within three (3) days after such notice is given, a daily storage fee will be charged, \$50.00 per day.
9. The Dealership is authorized to deliver the vehicle described herein or any of its contents to any person presenting this receipt.

DISCLAIMER OF WARRANTIES: NORM REEVES hereby expressly disclaims all warranties, either expressed or implied, including any implied warranty of merchantability or fitness for a particular purpose, and NORM REEVES neither assumes nor authorizes any other person to assume for it any liability in connection with the sale of said products. The only warranties which apply are those of the manufacturer.

NO PARTS WARRANTY ON

MOTORSPORT PERFORMANCE EQUIPMENT

Competition parts are sold "as is" without any warranty whatsoever. Implied warranties including warranties of merchantability or fitness for a particular purpose, are excluded. The entire risk as to quality and performance of such parts is with the buyer. Should such parts prove defective following their purchase, the buyer and not the manufacturer, distributor or retailer, assumes the entire cost of all necessary servicing or repairs. Ford Motor Company vehicle and parts warranties are voided if the vehicle or part is used for competition or if they fail as a result of modification.

WARNING: MOTORSPORT PERFORMANCE EQUIPMENT RESTRICTED USE

This part has been designed and is intended for off-highway application only. Installation on a vehicle intended for use on public roads may violate U.S., Canadian, state or provincial laws and regulations including those relating to emission requirements and motor vehicle safety standards. (NOTE: In California this part may legally be used only on racing vehicle which will never be operated on public roads.) In addition, installation of this part may adversely affect the warranty coverage on your vehicle.

ADJUSTMENT WARRANTY

NORM REEVES WARRANTS ALL ADJUSTMENT WARRANTY PERFORMED TO YOUR MOTOR VEHICLE AS SET FORTH ON THE REVERSE SIDE FOR A PERIOD OF ONLY 6 MOS. OR 6,000 MILES, WHICHEVER OCCURS FIRST. THIS TIME PERIOD AND MILEAGE SHALL COMMENCE FROM DATE ADJUSTMENT HAS BEEN COMPLETED.

LIMITED WARRANTY - LABOR

NORM REEVES WARRANTS ALL LABOR PERFORMED TO YOUR MOTOR VEHICLE AS SET FORTH ON THE REVERSE SIDE FOR A PERIOD OF ONLY 12 MONTHS OR 12,000 MILES, WHICHEVER OCCURS FIRST. THIS TIME PERIOD AND MILEAGE DETERMINATION SHALL COMMENCE FROM THE DATE THE LABOR HAS BEEN COMPLETED.

ALL WARRANTY WORK MUST BE PERFORMED BY NORM REEVES AT ITS PLACE OF BUSINESS LOCATED ON REVERSE SIDE. TO OBTAIN ANY WARRANTY WORK YOU MUST BRING YOUR MOTOR VEHICLE TO THIS ADDRESS PRIOR TO THE EXPIRATION OF YOUR WARRANTY.

THIS WARRANTY IS EFFECTIVE ONLY IF THE MOTOR VEHICLE IS OPERATED IN A NORMAL AND ORDINARY MANNER.

THIS WARRANTY IS NOT TRANSFERABLE AND MAY BE ENFORCED ONLY BY YOU SO LONG AS YOU OWN THE MOTOR VEHICLE TO WHICH THIS LABOR HAS BEEN PERFORMED.

ANY IMPLIED WARRANTIES YOU MAY BE ENTITLED TO BY LAW SHALL BE LIMITED IN DURATION TO THE DURATION OF THE ABOVE DESCRIBED EXPRESS WARRANTY.

THIS WARRANTY DOES NOT COVER PARTS OR ACCESSORIES THAT FAIL DUE TO ABUSE, MISUSE, NEGLIGENCE, ALTERATION OR ACCIDENT OR WHICH HAVE BEEN IMPROPERLY LUBRICATED OR REPAIRED, OR USED IN APPLICATIONS FOR WHICH THEY WERE EITHER NOT DESIGNED OR NOT APPROVED BY THE COMPANY, OR ARE CLEANED, ADJUSTED OR REPLACED AS A PART OF NORMAL MAINTENANCE, OR SPARK PLUGS THAT ARE OIL FOULED, LEAD FOULED OR WHICH FAIL DUE TO THE USE OF LOW-GRADE FUEL, IMPROPER SELECTION OF HEAT RANGE OR MISAPPLICATION, OR FAILURES CAUSED BY NON-FORD PARTS.

TO THE EXTENT ALLOWED BY LAW, LOSS OF TIME, INCONVENIENCE, LOSS OF USE OF THE VEHICLE, COMMERCIAL LOSS, OR CONSEQUENTIAL DAMAGES ARE NOT COVERED.

THERE IS NO OTHER EXPRESS WARRANTY ON FORD MOTOR COMPANY SUPPLIED REPLACEMENT PARTS AND ACCESSORIES, EXCEPT SUCH OBLIGATION AS FORD MAY HAVE ASSUMED IN ITS WARRANTY AND POLICY MANUAL OR OTHER SEPARATE WRITTEN INSTRUMENT.

ANY IMPLIED WARRANTY OF MERCHANTABILITY OR FITNESS IS LIMITED TO THE 12 MONTH/12,000 MILE DURATION OF THIS WRITTEN WARRANTY.

SOME STATES DO NOT ALLOW THE EXCLUSION OR LIMITATION OF CONSEQUENTIAL OR INCIDENTAL DAMAGES OR LIMITATION ON HOW LONG AN IMPLIED WARRANTY LASTS, SO THE ABOVE LIMITATION AND EXCLUSIONS MAY NOT APPLY TO YOU.

IMPORTANT NOTICE

"By law, you may choose another licensed Smog Check Facility to perform any needed repairs or adjustments that the Smog Check test indicates are necessary."

REMOVE ALL PERSONAL ARTICLES AND VALUABLES FROM YOUR VEHICLE.

WE ARE NOT RESPONSIBLE FOR LOSS OR DAMAGE TO YOUR VEHICLE OR TO PERSONAL ARTICLES LEFT IN YOUR VEHICLE.

GQ514561 0

WARNING:

Motor Vehicles contain chemicals known to the State of California to cause cancer and birth defects or other reproductive harm. These chemicals are contained in many vehicle components and replacement parts, vehicle fluids, and paints and materials used to maintain vehicles, including, but not limited to, fuel, oil, batteries, brakes, and wheel balancing weights. When you service, clean or maintain your car, you will be exposed to listed chemicals contained in used oil, waste and replacement fluids, fumes, grease, grime, touch-up paint, certain replacement parts, and particulates from component wear. When we service your car, we will return used components to you upon request. Used parts and components contain chemicals known to the State of California to cause cancer and birth defects or other reproductive harm.

To minimize your exposure when servicing, maintaining or cleaning your vehicle: 1) work in a well ventilated area; 2) do not smoke, drink or eat while working; 3) wash your hands when finished or when taking a break; and 4) follow all manufacturer instructions pertaining to proper use and maintenance of motor vehicles and vehicle components.

(Posted in accordance with Proposition 65 in Cal. Health & Safety Code §25249.5 et seq.) For further information about Proposition 65: <http://www.oehha.org/prop65.html>.



TRAKEY OWNED & OPERATED SINCE 1907
 P.O. BOX 668 700 WEST COMMONWEALTH
 FULLERTON, CALIFORNIA 92832
 (714) 526-5501
 www.mccoymillsford.com

[REDACTED]
 DOWNEY, CA [REDACTED]
 SERVICE ADVISOR ANDREW NAO

BAR # ARD 000174 EPA # CAD 981657141

REPAIR ORDER WRITTEN	DATE READY	STOCK NO.	VEHICLE IDENTIFICATION	CUST. NO.	TAG NO.	P.O. NO.	INVOICE PRINTED	INVOICE NO.
03AUG18	03AUG18		1FM5K7D84DC [REDACTED]	[REDACTED]	[REDACTED]		03AUG18	[REDACTED]
TIME IN	TIME READY	YEAR	MAKE & MODEL	TELEPHONE NO.	CUST. PAY LABOR RATE	DELIVERY DATE	PREPARED BY	S/A
		13	FORD EXPLORER	[REDACTED]		15JUN13	312	443
MILEAGE IN		LICENSE NO.						
102336	102336	[REDACTED]						

TECH	TYPE	HOURS	LIST PRICE	REMARKS	TOTAL
A	DIAG			CHECK ENGINE LIGHT IS ON	
	A99			DIAG CHECK ENGINE LIGHT IS ON CODE P0430 CAT BELOW THRESHOLD BANK 2 ADVISE TO REPLACE BANK 2 CAT	
		130	CP	1.00	142.00
B	CHECK TIRE PRESSURE			TP35 AIR TIRES LF 35PSI RF 35PSI LR 35PSI RR 35PSI	
		130	CP	0.00	0.00
C	BRAKES - TIRES - BATTERIES			99P BRAKES - TIRES - BATTERIES	
		130	CP	0.00	0.00
EST: 142.00 03AUG18 09:11 SA: 443					



"WE CARE" SINCE 1930



**** PRE-INVOICE ****

"For Your Convenience"

PARTS DEPARTMENT HOURS:
 MONDAY THRU FRIDAY
 8:00 A.M. TO 6:00 P.M.
 SATURDAY
 8:00 A.M. TO 4:00 P.M.

SERVICE DEPARTMENT HOURS:
 MONDAY THRU FRIDAY
 7:00 A.M. TO 6:00 P.M.
 SATURDAY
 8:00 A.M. TO 4:00 P.M.

BODY SHOP HOURS:
 MONDAY THRU FRIDAY
 7:00 A.M. TO 5:30 P.M.
 CLOSED SAT. & SUN.

DESCRIPTION	TOTALS
LABOR AMOUNT	142.00
PARTS AMOUNT	0.00
GAS,OIL, LUBE	0.00
SUBLET AMOUNT	0.00
MISC. CHARGES	0.00
TOTAL CHARGES	142.00
LESS / ADJ.	0.00
SALES TAX	0.00
PLEASE PAY THIS AMOUNT	142.00

ORIGINAL ESTIMATE	AUTHORIZED ADDITIONS

I acknowledge notice and oral approval of an increase in the original estimated price.

X _____
 CUSTOMER SIGNATURE

X _____
 CUSTOMER SIGNATURE

*****PLEASE HELP US!!!!*****
 FORD MOTOR COMPANY MAY SEND YOU A SERVICE SURVEY FOR CUSTOMER VIEWPOINT. PLEASE FILL IT OUT. WE NEED YOUR SURVEY!!
 WE ARE PROUD OF OUR DEALERSHIP.
 THANK YOU!!!!!!

[Handwritten Signature]

AS IS

The only warranties applying to this part(s) are those which may be offered by the manufacturer. The selling dealer hereby expressly disclaims all warranties, other express or implied, including any implied warranties of merchantability or fitness for a particular purpose, and neither assumes nor authorizes any other person to assume for it any liability in connection with the sale of this part(s) and or service. Buyer shall not be entitled to recover from the damages to property, damages for loss of use, loss of time, loss of profits, or income, of any other incidental damages.

ENVIRONMENTAL COMPLIANCE CHARGE

Maintaining and repairing your car inevitably involves the use of chemicals and generations of wastes (solvents, oils, caustics, lead, asbestos, etc.) that must be stored, managed and disposed of in strict compliance with federal, state, and local environmental regulations. We support these regulations and also believe our customers do too because they help ensure a safer, healthier environment for everyone. Complying with those regulations increases the cost of service. Ordinarily, increased costs simply result in an increased hourly labor charge. This dealership has decided in lieu of raising its labor rate, to list a compliance charge on appropriate service bills because we believe our customers would be interested to know that they are helping to pay for a cleaner environment.

TO OUR SERVICE CUSTOMERS:

Our usual charges for labor are not based on actual mechanic's time, but are simply our prices for particular jobs. You will be charged no more than the estimated price approved by you. However, if we discover that different or actual repairs are indicated, you will be contacted for your advanced approval of a revised estimate.

1. Customer is hereby notified that the said property is not insured or protected to the amount of the actual cash value thereof, or otherwise, against loss occasioned by theft, fire or vandalism while the property remains with the dealer.

2. Customer states no articles of personal property have been left in the vehicle and dealer is not responsible for inspection thereof.

3. The dealer is not responsible for unavailability of parts or delays in parts shipment beyond the dealer's control.

4. Due to the type of service requested some repairs must be sublet.

5. All charges for repairs including labor and materials furnished are due and payable simultaneously with the delivery of the within described vehicle or prior to delivery upon the expiration of three (3) days after notice that the repairs have been completed. Notice shall be deemed to have been given upon the deposit in the United States mail, postage prepaid, of written notification to that effect addressed to the customer at the address given on the reverse side hereof.

6. If the vehicle described herein is not called for within three (3) days after such notice is given, a storage charge of \$25.00 per day will be made for each day thereafter.

7. Said dealer is authorized to deliver the vehicle described herein of any of its content to any person presenting this receipt.

8. In addition to any and all other legal remedies available, I authorize Said Dealer to have a lien on the vehicle described herein for all changes for repairs, including labor and parts, storage and/or towing, and to enforce such lien. Said Dealer is hereby expressly authorized to sell said vehicle at public auction after giving a twenty (20) day written notice by certified mail to the legal owner, registered owner, and Department of Motor Vehicle of intent to do so. On the sale date, the vehicle shall be sold to the highest cash bidder and the proceeds of sale must be used first to satisfy the lien plus storage costs and costs incident to sale, and the balance shall be forwarded to the legal owner, or if none, to the registered owner, or if the address is unknown, it shall be forward to the Department of Motor Vehicles.

Said expenses for sale shall also include a reasonable attorney's fee, which may be necessarily incurred.

9. If any such charges remain unpaid for thirty (30) days after such request for payment, Said Dealer may also refer such charges to his attorneys for collection and the customer will pay a reasonable attorney's fee.

STATEMENT CONCERNING AMENDMENTS TO THE SONG-BEVERLY WARRANTY ACT AS FOLLOWS:

"A buyer of this product in California has the right to have this product serviced or repaired during the warranty period. The warranty period will be extended for the number of whole days that the product has been out of the buyer's hands for warranty repairs. If a defect exists within the warranty period, the warranty will not expire until the defect has been fixed. The warranty period will also be extended if the warranty repairs have not been performed due to delays caused by circumstances beyond the control of the buyer, or if the warranty repairs did not remedy the defect and the buyer notifies the manufacturer or seller of the failure of the repairs within 60 days after they were completed. If, after a reasonable number of attempts, the defect has not been fixed, the buyer may return this product for a replacement or a refund subject, in either case, to deduction of a reasonable charge for usage. This time extension does not affect the protections or remedies the buyer has under other laws."

WARNING:

California Health & Safety Code Section 25249.6 - Proposition 65: Some of the materials being removed and used during the servicing of vehicles are known to the State of California to cause cancer, birth defects or other reproductive harm.

CALIFORNIA EMISSIONS REFEREE STATIONS INFORMATION

- A. Customer may be sent to a Referee station by the Bureau of Automotive Repair if:
1. Motorist's vehicle failed the initial inspection when he/she thinks it shouldn't have.
 2. Motorist has a dispute with repair facility (e.g., cost/quality of repair work is in dispute).
 3. Motorist has had vehicle repaired resulting in no emission reduction or increase emissions, and which would exceed the cost limits if additional repairs are made, will be referred to a Referee Station for retesting.
- B. Customer may go directly to a Referee Station if:
1. It is obvious that no repairs can be done for less than the cost limit.
 2. It is to verify non-availability of emissions control components.

Norm Reeves Ford Lincoln
18900 Studebaker Road
Cerritos , CA 90703
(562) 469-5915

RECEIPT

Customer Information:

[REDACTED]
[REDACTED]
[REDACTED]

Invoice Details:

Invoice #: [REDACTED]
Invoice Date: Friday, June 23, 2017 04:33 PM

Repair Order/Ref #: [REDACTED]

Description of Product/Services	Amount
Service Performed	\$ 140.00

Payment Details:

Paid On: Friday, June 23, 2017 05:22 PM

Credit Card [REDACTED]
/XXXX

Card Type: Visa

Cardholder Name: [REDACTED]

Payment Type: Swiper

Confirmation #: [REDACTED]
[REDACTED]

Customer Signature

THANK YOU!

Norm Reeves Ford Lincoln

Processed by myKaarma eBridge
Payments



Case Print Report

Case Numb [REDACTED]

Case Opened Date 11/8/2018 7:13 PM

Case Closed Date 11/8/2018 7:20 PM

Case Status Resolved

Case Last Modified 11/8/2018 7:20 PM

Responsible Team Tier 1 Inbound

Case Classification Legal > Alleged Accident/Property Damage or Fire (Visible flames) due to Product Defect > Insurance Company Contacted/ settlement > Requests Financial Assistance

Customer Name [REDACTED]

Customer Num [REDACTED]

TRACY

CA [REDACTED]

Email

Dealer

VIN 1FM5K8GT4F [REDACTED]

Year 2015

Make FORD

Model EXPLORER

Body Style K8G - EXPLORER SPORT 4WD 4-DR

Symptom

Level 1 Safe & Secure

Level 2 Smoke/Odor

Level 3 Exhaust

Level 4 OTHER

Case Print Report

Case Number [REDACTED]

Agent Name	Note Created On
Chera Lansang	11/8/2018 7:17 PM

Cust says: The veh has a Carbon Monoxide and the driver and the passenger passed out and hit a tree. Want to reimburse all the payments for the veh and the payoff and Want Ford to take over everything and Don't want to get any attorney. I just want Ford will do everything that needs to be done. Don't want to wait the maximum of 15 days or else Ford will hear on the news.

As per dealer says: N/A

CRC advised: I will forward your information to Ford's Office of the General Counsel. You should receive a written response within 15 Days business days to your concern.

Has the customer filed a claim with their insurance company? (Yes or No)

•If YES, continue with remaining questions.

2. If a claim has been filed with their insurance company, what is the status of the claim? Yes

3. Is the vehicle repairable? Totalled

4. Were any injuries sustained? If yes, provide the first and last name of all injured parties. [REDACTED]

[REDACTED] don't know the last name.

5. What are you seeking from Ford Motor Company? Want to reimburse all the payments for the veh and the payoff and Want Ford to take over everything and Don't want to get any attorney. I just want Ford will do everything that needs to be done.

6. What was the date of the accident? November 6, 2018

7. What product defect is alleged to have caused the accident? Carbon Monoxide in the veh and the people inside it passed out.

8. What is the city and state where the accident occurred? Tracy California

9. Was a police report filed? No.

10. If a police report was filed, what were the findings? n/a

11. What is the police report number and in what city and county was the report filed? n/a

12. What is the name and address of the customer's attorney (Ask this question only if the customer mentions they have sought/retained an attorney)? n/a

13. What mailing address would you like our Office of General Council to send your written response to (Document the full address)? [REDACTED] RACY C [REDACTED]

Case Print Report

Case Number [REDACTED]

Activity Modified By	Activity Last Modified	Activity Type	Activity Subject
Chera Lansang	11/8/2018 7:20 PM	fmc_closecase	Close Case
Chera Lansang	11/8/2018 7:20 PM	incidentresolution	Case Resolution



MORGAN:MORGAN
[FOR THE PEOPLE]



FL

November 16, 2018

VIA FEDERAL EXPRESS TO:
FORD MOTOR COMPANY
Customer Relationship Center
1 American Road
Dearborn, MI 48126

RECEIVED

NOV 26 2018

Tracking No.

VIA FEDERAL EXPRESS TO:
FORD CUSTOMER SERVICE DIVISION
16800 Executive Plaza Drive
Dearborn, MI 48121

Tracking No.

VIA FEDERAL EXPRESS TO:
PRESTIGE LINCOLN MERCURY
3333 North Main Street
Gainesville, FL 32609

Tracking No.

Customer:
Vehicle: 2017 Ford Explorer
VIN: 1FM5K7F88HC
Dealer: Prestige Lincoln Mercury

Dear Madam/Sir:

Please be advised that this office represents regarding his claims against your company pursuant to the federal Magnuson-Moss Warranty Act. Mr. claims stem

from his purchase of a 2017 Ford Explorer warranted by your company. Please direct all future contacts and correspondence regarding this matter to our office. **Having been formally notified of our representation, you are instructed not to contact our client under any circumstances. If you fail to act in conformity with this directive, injunctive relief will be sought against you.**

Additionally, you are hereby notified that any settlement made with our client must include compensation for all statutory and other relief available to a consumer, including attorneys' fees and costs. If you settle directly with our client, and do not make arrangements for payment of fees and costs, we will file suit against you. In addition, you are hereby notified of our attorneys' fees lien in regard to this matter.

My client has retained us with regard to numerous defects and non-conformities present in the subject vehicle, which are still present after numerous unsuccessful repair attempts. These defects and non-conformities include, but are not limited to:

1. Fumes in cabin of vehicle; and,
2. All additional complaints made by our client, whether or not they are contained in your company's records or on any dealer repair orders.

My client has already given you and your authorized service sales and service providers multiple opportunities to correct the issues with the subject vehicle, but it remains in a defective state.

The defects and non-conformities listed above constitute a substantial impairment of the use, value and/or safety of the subject vehicle. Your failure and/or refusal to repair said defects and non-conformities in accordance with the terms of your warranty, constitutes a breach of warranty entitling my client to recovery. *See Rastaedi v. Mercedes-Benz USA, LLC*, 63 So. 3d 41 (Fla. 4th DCA 2011); *Ocana v. Ford Motor Company*, 992 So. 2d 319 (Fla. 3d DCA 2008); *Zelyony v. Porsche Cars N. Am., Inc.*, 2008 U.S. Dist. LEXIS 31439 (S.D. Fla. 2008).

To the extent that my client has not already placed you on notice, you are hereby notified that your failure to successfully repair the defects and non-conformities in the subject vehicle constitutes a breach of your warranty. The repair history for the subject vehicle clearly shows that you have been unable or unwilling to correct the defect and nonconformities, after being a reasonable opportunity to do so. Accordingly, your warranty has failed of its essential purpose, and my client is entitled to seek any remedy available at law. *See Frank Griffin Volkswagen, Inc. v. Smith*, 610 So. 2d 597 (Fla. 1st DCA 1992); *Burns v. DaimlerChrysler*, 914 So.2d 451 (Fla. 4th

DCA 2006).

Pursuant to Uniform Commercial Code § 2-711(3), my client has a security interest in the vehicle for return of the amounts described herein, plus expenses in handling and inspecting the subject vehicle. Unless you agree to repurchase my client's vehicle, and return all payments made by my client, my client will hold the vehicle and use it to the extent necessary to preserve it, to protect the security interest, and to minimize your damages. Moreover, my client needs return of the monies listed above before a substitute vehicle can be acquired. In addition, any attempt by you or your agents to repossess the subject vehicle will be wrongful and may subject you to liability for conversion and for wrongful repossession under Uniform Commercial Code §9-503 and §9-507, as well as any other applicable state and federal remedies.

It is my client's contention that you have already been provided with sufficient opportunities to cure the breach of warranty. However, if you are interested in making an additional attempt to cure the breach of warranty, my client has authorized me to demand that you repurchase the subject vehicle and pay \$3,000.00 for my client's attorneys' fees and costs in order to resolve this matter. My client will also agree to execute a mutually agreed upon release agreement as a condition of settlement.

If I do not hear from you within ten (10) days of your receipt of this correspondence, I will presume you are uninterested in making any further attempts to cure the breach of warranty and/or otherwise attempting to resolve this matter, and we will proceed with litigation. Thank you for your time and attention to this matter, and I look forward to the receipt of your prompt responses.

Sincerely,

Jeremy Kespohl, Esquire
Morgan & Morgan

Please Respond To:

Karie Salvi
Case Manager to Jeremy Kespohl
ksalvi@forthepeople.com
(904) 361-4436 Direct Line
(904) 361-4321 Facsimile