

EA16-002

FLAT CHRYSLER

5-12-2016

ENCLOSURE 04

CAIR Backup

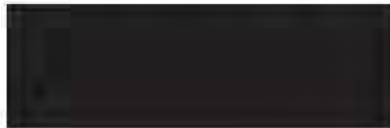

PP 6156774 B









Vehicle View

Roll over an ECU to see full name. Click on an ECU for complete details.

Search Service Information



2012 LX 3.6L
 VIN: 2C3CCAAG5CH [REDACTED]
 Battery: 12.06 volts

Legend

- Active ECU
- Non-responsive ECU
- DTCs Present
- ECU Not Built
- Scanning ECU
- ⚡ New Flash Available
- CAN-C
- CAN-HS

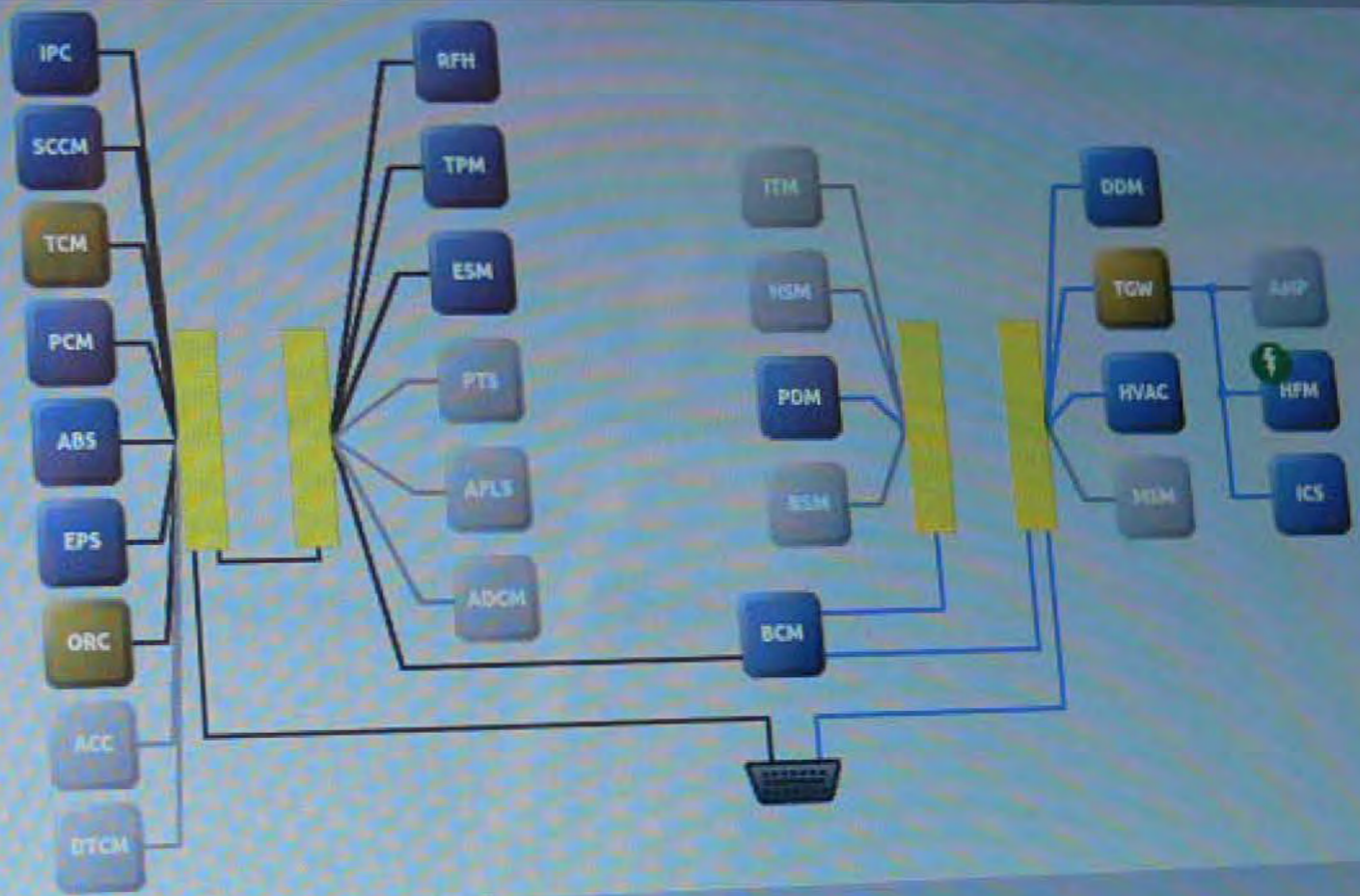

All DTCs Diagnostic Procedures Customer Preferences Vehicle Preparations

View Freeze Frame View Event Data Clear Stored DTCs

Double-click row selection to view environmental data. Click on column heading to sort table.

All Active Stored Pending				Description
ECU	Code	Status		
TCM	P1DC7-00	Stored		Clutch Temp Threshold Achieved - Shift Time Reduction
TCM	P1DC9-00	Stored		Clutch Temp Threshold Achieved - Skip Shift Down Inhibit
ORC	P002R-13	Active		Right Side Seat Deployment Switch 1 Circuit Open

(1) New knowledge base articles Online ERAccess - R7CPY...

wi 14.01.20

Disconnect Warnings: 0 Errors: 0 11:56 AM 1/6/2014



Vehicle View

Roll over an ECU to see full name. Click on an ECU for complete details.

Search Service Information

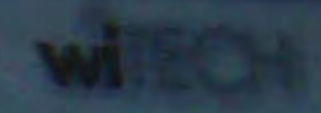

2012 LX 3.6L

VIN: 2C3CCAAG5C

Battery: 12.06 volts

Legend

- Active ECU
- Non-responsive ECU
- DTCs Present
- ECU Not Built
- Scanning ECU
- New Flash Available
- CAN-C
- CAN-HS

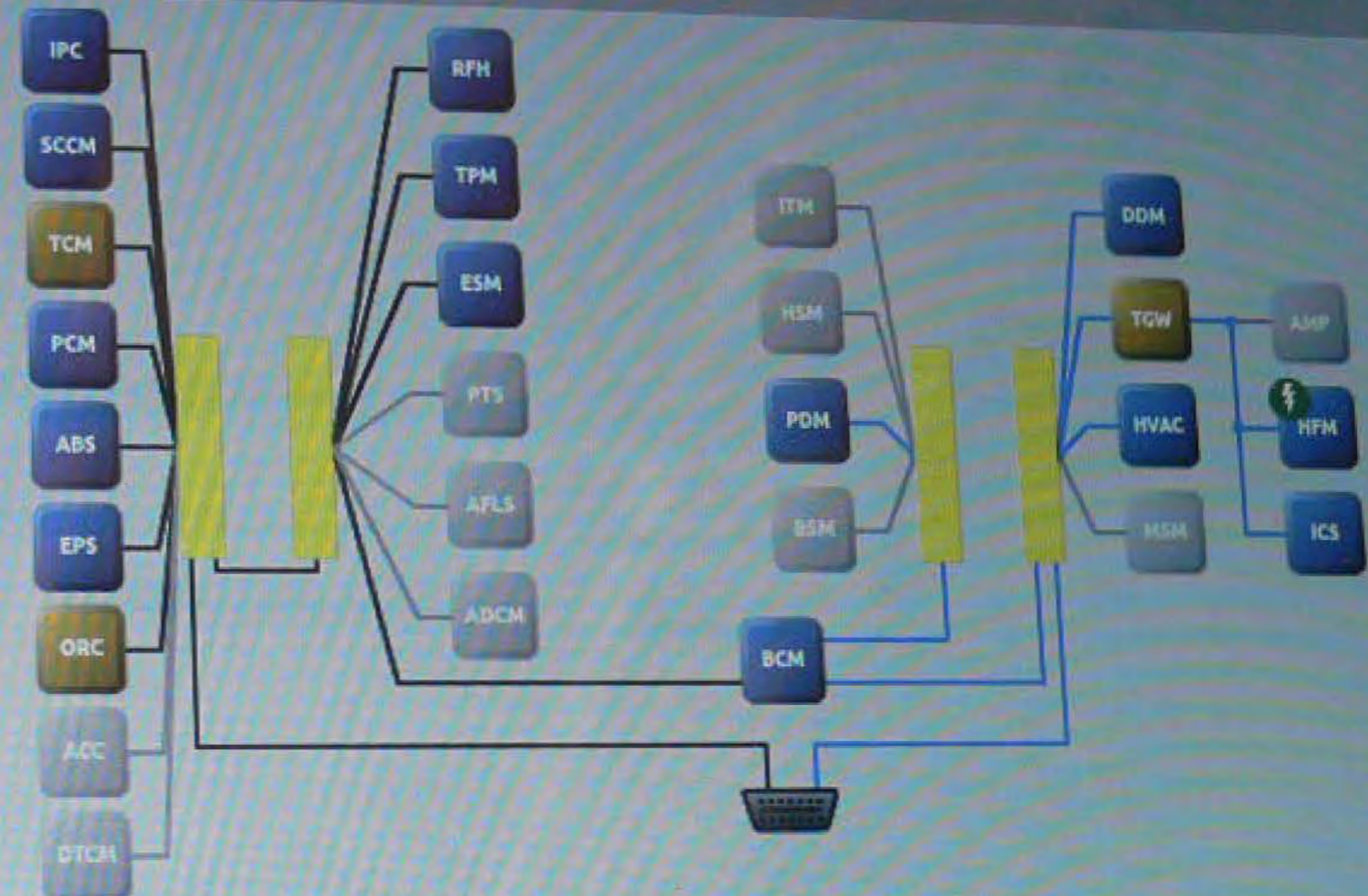

All DTCs Diagnostic Procedures Customer Preferences Vehicle Preparations

Double-click row selection to view environmental data. Click on column heading to sort table.

All | Active | Stored | Pending

ECU	Code	Status	Description
ORC	B0028-13	Active	Right Side Seat Deployment Squib 1-Circuit Open
TGW	B156B-2B	Stored	Satellite Radio Antenna-Wires Shorted Together
TCM	R1572-00	Stored	CD/DVD Read Error - Inoperable Disc

Disconnect Warnings: 0 Errors: 0

(1) New knowledge base articles

Online

ERAccess - R7CPY...

wi 14.01.20

11:57 AM 1/6/2014



Vehicle View

Roll over an ECU to see full name. Click on an ECU for complete details.

Search Service Information



2012 LX 3.6L
 VIN: 2C3CCAAG5CH [REDACTED]
 Battery: 12.02 volts

Legend

- Active ECU
- Non-responsive ECU
- DTCs Present
- ECU Not Built
- ♻️ Scanning ECU
- ⚡ New Flash Available
- CAN-C
- CAN-IHS

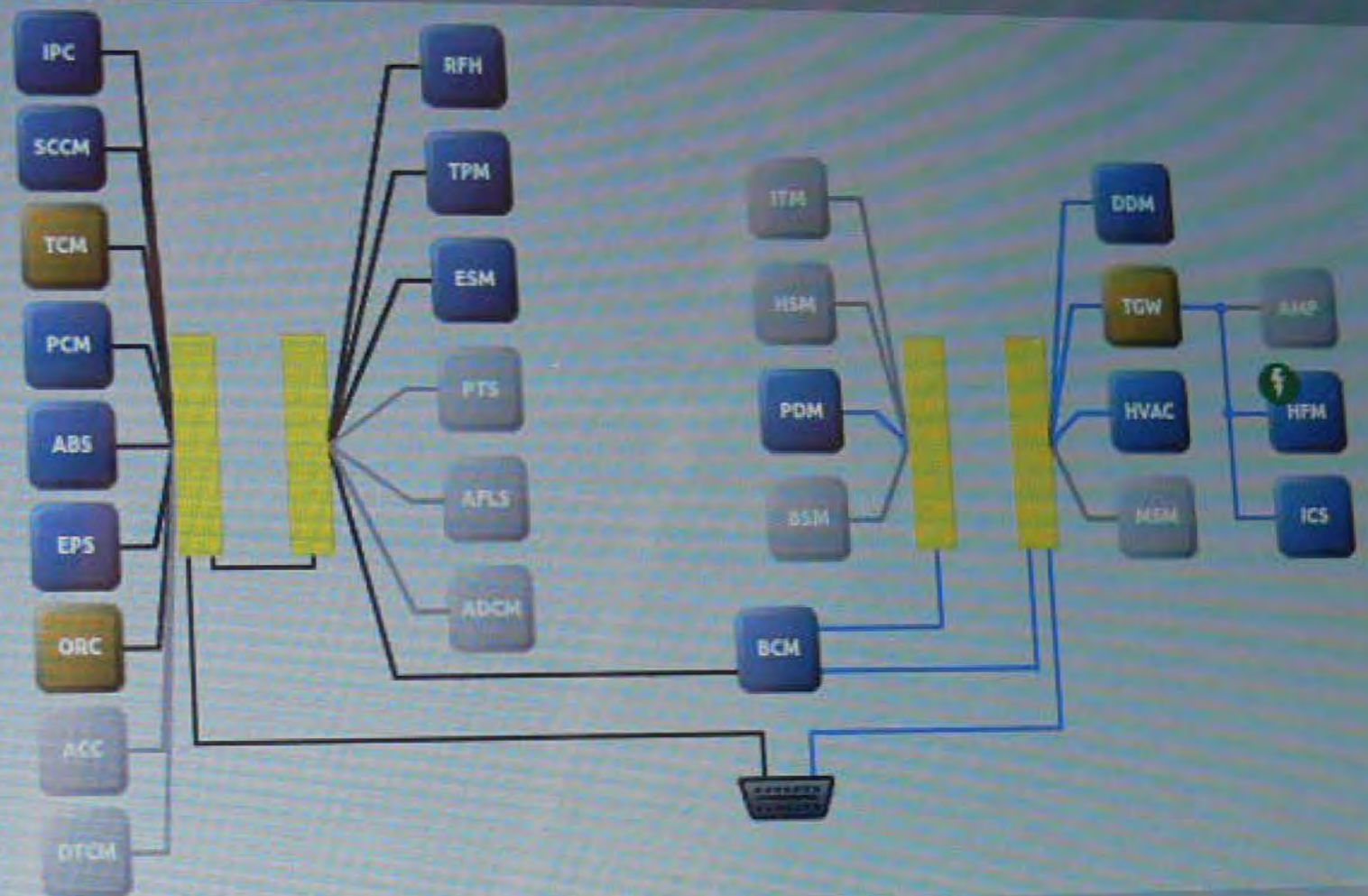

All DTCs Diagnostic Procedures Customer Preferences Vehicle Preparations

Double-click row selection to view environmental data. Click on column heading to sort table.

All Active Stored Pending

ECU	Code	Status	Description
ORC	B0028-13	Active	Right Side Seat Deployment Squib T-Circuit Open
TGW	B156B-2B	Stored	Satellite Radio Antenna-Wires Shorted Together
TGW	B1572-00	Stored	CD/DVD Read Error - Inoperable Disc-

Warnings: 0 Errors: 0

(1) New knowledge base articles Online ERAccess - R7CPY...

14.01.20

Disconnect 11:58 AM
1/6/2014



Double-click row selection to view environmental data. Click on column heading to sort table.

All | Active | Stored | Pending

View Freeze Frame View Event Data Clear Stored DTCs

	ECU	Code	Status	Description
	TCM	P1DC7-00	Stored	Clutch Temp Threshold Achieved - Shift Time Reduction-
	TCM	P1DC9-00	Stored	Clutch Temp Threshold Achieved - Skip Shift Down Inhibit-

Click on the buttons to view the desired information. Click on column heading to sort table.

Environmental Data Snapshot Data

Environmental Data for TCM | P1DC7-00 Clutch Temp Threshold Achieved - Shift Time Reduction-

Name	Value	Units
Test Failed	False	
Test Failed This Operation Cycle	False	
Pending DTC	False	
Confirmed DTC	True	
Test Not Completed Since Last Clear	False	
Test Failed Since Last Clear	True	

Disconnect Warnings: 0 Errors: 0

Online

ERAccess - R7CPY...

12:04 PM
1/6/2014

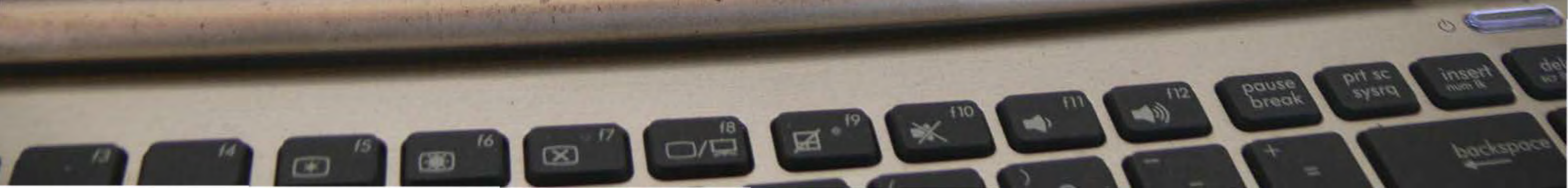

Double-click row selection to view environmental data. Click on column heading to sort table.

All | Active | Stored | Pending

ECU	Code	Status	Description
TCM	P1DC7-00	Stored	Clutch Temp Threshold Achieved - Shift Time Reduction
TCM	P1DC9-00	Stored	Clutch Temp Threshold Achieved - Skip Shift Downshift

View Freeze Frame View Event Data Clear Stored DTCs

Click on the buttons to view the desired information. Click on column heading to sort table.

Environmental Data for TCM | P1DC7-00 Clutch Temp Threshold Achieved - Shift Time Reduction-

Environmental Data Snapshot Data

Name	Value	Units
Test Failed Since Last Clear	True	
Test Not Completed This Operation Cycle	True	
Warning Indicator Requested	False	
DTC Extended Data Record Number - All	01	
Occurrence flag	Error	

Disconnect Warnings: 0 Errors: 0



Double-click row selection to view environmental data. Click on column heading to sort table.

All | Active | Stored | Pending

ECU	Code	Status	Description
TCM	P1DC7-00	Stored	Clutch Temp Threshold Achieved - Shift
TCM	P1DC9-00	Stored	Clutch Temp Threshold Achieved - Shift with gear inhibit

View Freeze Frame View Event Data Clear Stored DTCs

Click on the buttons to view the desired information. Click on column heading to sort table.

Environmental Data Snapshot Data

Environmental Data for TCM | P1DC7-00 Clutch Temp Threshold Achieved - Shift Time Reduction-

Name	Value	Units
Test Not Completed This Operation Cycle	True	
Warning Indicator Requested	False	
DTC Extended Data Record Number - All	01	
Occurrence flag	Error	miles
Original Odometer Value	55312	miles
Most Recent Odometer Value	56035	

Disconnect Warnings: 0 Errors: 0

12:05 PM 1/5/2014



Double-click row selection to view environmental data. Click on column heading to sort table.

All | Active | Stored | Pending

ECU	Code	Status	Description
TCM	P1DC7-00	Stored	
TCM	P1DC9-00	Stored	Clutch Temp Threshold Achieved - Shift Time Reduction-
			Clutch Temp Threshold Achieved - Skip Shift Down Inhibit-

View Freeze Frame View Event Data Clear Stored DTCs

Click on the buttons to view the desired information. Click on column heading to sort table.

Environmental Data for TCM | P1DC9-00 Clutch Temp Threshold Achieved - Skip Shift Down Inhibit-

Environmental Data Snapshot Data

Name	Value	Units
Test Failed	False	
Test Failed This Operation Cycle	False	
Pending DTC	False	
Confirmed DTC	True	
Test Not Completed Since Last Clear	False	
Test Failed Since Last Clear	True	

Disconnect Warnings: 0 Errors: 0

Online ERAccess - R7CPY...

12:06 PM 1/6/2014



Click on selection to view environmental data. Click on column heading to sort table.

All | Active | Stored | Pending

ECU	Code	Status	Description
TCM	P1DC7-00	Stored	
TCM	P1DC9-00	Stored	Clutch Temp Threshold Achieved - Shift Time Reduction-
			Clutch Temp Threshold Achieved - Skip Shift Down Inhibit-

View Freeze Frame | View Environmental Data | Clear Stored DTCs

Click on the buttons to view the desired information. Click on column heading to sort table.

Environmental Data for TCM | P1DC9-00 Clutch Temp Threshold Achieved - Skip Shift Down Inhibit-

Environmental Data | Snapshot Data

Name	Value	Units
Test Not Completed Since Last Clear	False	
Test Failed Since Last Clear	True	
Test Not Completed This Operation Cycle	True	
Warning Indicator Requested	False	
DTC Extended Data Record Number - All	01	
Occurrence flag	Error	

Disconnect | Warnings: 0 Errors: 0

Online | ERAccess - R7CPY... | 12:06 PM 1/6/2014

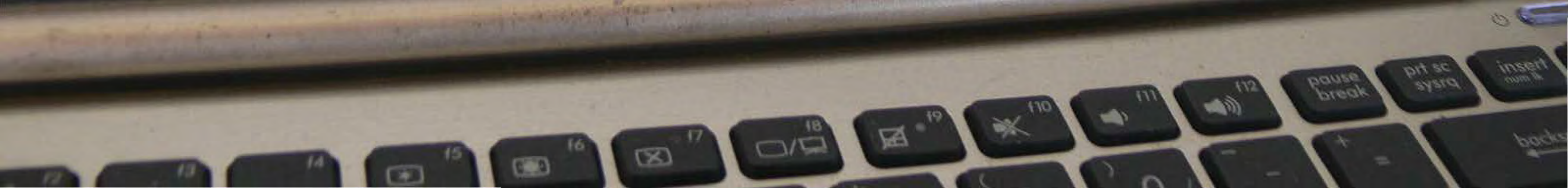

ECU	Code	Status	Description
TCM	P1DC7-00	Stored	
TCM	P1DC9-00	Stored	Clutch Temp Threshold Achieved - Shift Time Reduction
			Clutch Temp Threshold Achieved - Skip Shift Down Inhibit

Click on the buttons to view the desired information. Click on column heading to sort table.

Environmental Data for TCM | P1DC9-00 Clutch Temp Threshold Achieved - Skip Shift Down Inhibit-

Name	Value	Units
Test Not Completed This Operation Cycle	True	
Warning Indicator Requested	False	
DTC Extended Data Record Number - All	01	
Occurrence flag	Error	
Original Odometer Value	55312	miles
Most Recent Odometer Value	56035	miles

Warnings: 0 Errors: 0

ERAccess - R7CPY...



2012 LX
VIN: 2C3
Battery:
Legend
Acti
Non
DTC
ECU
Sca
New
CAN
CAN

All DTCs
Double-click
Activ
A
(1) New k

TECH

Event Data Report

Control Panel

Include Bank 1 Event Data
 Include Bank 2 Event Data
 Include Bank 3 Event Data
 Include Bank 4 Event Data
 Include Bank 5 Event Data
 Include Bank 6 Event Data
 Compare Side-by-Side

DTC	P1DC7-00 - Clutch Temp Threshold Achieved - Shift Time Red	
Odometer from CAN bus	57513	miles
Time since module power-up	FF 36 48 82	ms
Turbine Speed Sensor	4128.0	rpm
Output Speed Sensor	4128	rpm
Transmission Oil Temperature	77	F

Bank 2 | P1DC7-00 - Clutch Temp Threshold Achieved - Shift Time Reduction | TCM

Name	Value	Units
DTC	P1DC7-00 - Clutch Temp Threshold Achieved - Shift Time Red	
Odometer from CAN bus	57513	miles
Time since module power-up	FF 40 4D 83	ms
Turbine Speed Sensor	4128.0	rpm
Output Speed Sensor	4128	rpm
Transmission Oil Temperature	70	F

14.01.20 Reports ERAccess - R7CPY...



Search

Enter search phrase here

TECH

Event Data

Clear Stored DTCs

Warning: 0 Errors

12:20 PM
1/6/2014

TECH

Control Panel

- Include Bank 1 Event Data
- Include Bank 2 Event Data
- Include Bank 3 Event Data
- Include Bank 4 Event Data
- Include Bank 5 Event Data
- Include Bank 6 Event Data
- Compare Side-by-Side

Chip1 - Temperature	-40	F
Chip2 - Temperature	-38	F
Torque Converter Oil Temperature	-40	F
State of parking brake	AF	
Status of parking brake	70	

Bank 2 | P1DC7-00 - Clutch Temp Threshold Achieved - Shift Time Reduction | TCM

Name	Value	Units
Chip1 - Temperature	-40	F
Chip2 - Temperature	-38	F
Torque Converter Oil Temperature	-40	F
State of parking brake	B0	
Status of parking brake	70	
State of parking brake	B0	

Event Data

Warnings: 0 Errors: 0

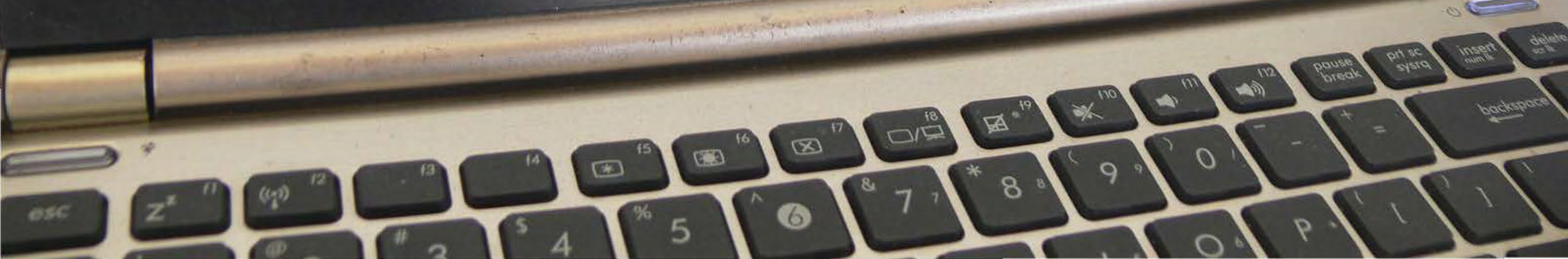

012 LX
VIN: 2C3
Battery:
Legend
Acti
Non
DTC
ECU
Sca
New
CAN
CAN

DTCs
ble-click
Activ
A
1) New k

Event Data Report

Control Panel

- Include Bank 1 Event Data
- Include Bank 2 Event Data
- Include Bank 3 Event Data
- Include Bank 4 Event Data
- Include Bank 5 Event Data
- Include Bank 6 Event Data
- Compare Side-by-Side

State of parking brake	AF	
Status of parking brake	70	
State of parking brake	AF	
Battery Voltage	1.3	V
Sensor Supply Voltage	14.6	V

Bank 2 | P1DC7-00 - Clutch Temp Threshold Achieved - Shift Time Reduction | TCM

Name	Value	Units
State of parking brake	B0	
Battery Voltage	1.3	V
Sensor Supply Voltage	14.6	V
Voltage of Pressure Regulator and Valves	0.0	V
Park Sensor Input Line 4	Off	
Park Sensor Input Line 3	Off	

14.01.20 Reports ERAccess - R7CPY...



Event Data Report

Search

Enter search

Control Panel



- Include Bank 1 Event Data
- Include Bank 2 Event Data
- Include Bank 3 Event Data
- Include Bank 4 Event Data
- Include Bank 5 Event Data
- Include Bank 6 Event Data
- Compare Side-by-Side

Buffered Flag for Mech-Limphome	8F	
Shift Solenoid A Current	216	mA
Shift Solenoid D Current	516	mA
Shift Solenoid B Current	556	mA
Shift Solenoid E Current	1000	mA

Bank 2 | P1DC7-00 - Clutch Temp Threshold Achieved - Shift Time Reduction | TCM

Name	Value	Units
Torque Converter Clutch Current	0	mA
Pressure Control Solenoid Current	272	mA
Park Solenoid Current	0	mA
Current OUT10	0	mA
Current OUT11	0	mA
CAN-Output for the display	00	



14.01.20



Reports



ERAccess - R7CPY...



Event Data Report

TECH

Control Panel

- Include Bank 1 Event Data
- Include Bank 2 Event Data
- Include Bank 3 Event Data
- Include Bank 4 Event Data
- Include Bank 5 Event Data
- Include Bank 6 Event Data
- Compare Side-by-Side

Shift Solenoid C Current	0	mA
Torque Converter Clutch Current	0	mA
Pressure Control Solenoid Current	272	mA
Park Solenoid Current	0	mA
Current OUT10	0	mA

Bank 2 | P1DC7-00 - Clutch Temp Threshold Achieved - Shift Time Reduction | TCM

Name	Value	Units
Torque Converter Clutch Current	0	mA
Pressure Control Solenoid Current	272	mA
Park Solenoid Current	0	mA
Current OUT10	0	mA
Current OUT11	0	mA
CAN-Output for the display	00	

ASUS laptop keyboard and taskbar area. Taskbar includes: Windows logo, Wi-Fi icon, date 14.01.20, Reports icon, ERAccess - R7CPY... icon, and system tray with time 12:31 and date 16.03.

Event Data Report

Search

TECH

Report

Control Panel



- Include Bank 1 Event Data
- Include Bank 2 Event Data
- Include Bank 3 Event Data
- Include Bank 4 Event Data
- Include Bank 5 Event Data
- Include Bank 6 Event Data
- Compare Side-by-Side

Pressure Control Solenoid Current	272	mA
Park Solenoid Current	0	mA
Current OUT10	0	mA
Current OUT11	0	mA
CAN-Output for the display	00	

Bank 2 | P1DC7-00 - Clutch Temp Threshold Achieved - Shift Time Reduction | TCM

Name	Value	Units
Torque Converter Clutch Current	0	mA
Pressure Control Solenoid Current	272	mA
Park Solenoid Current	0	mA
Current OUT10	0	mA
Current OUT11	0	mA
CAN-Output for the display	00	

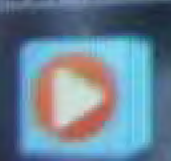

14.01.20

wi Reports



ERAccess - R7CPY...





ORC View

Click on tabs to access various ECU operations and information for the selected ECU.

Search Service Information

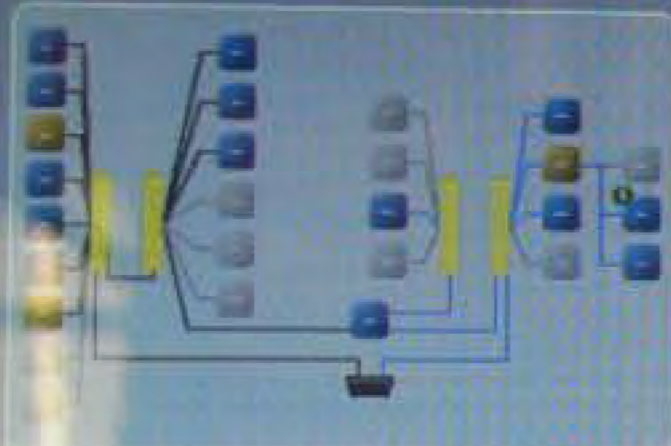

- Flash
- Data
- DTCs**
- Actuators
- System Tests
- Misc Functions
- ECU Details

Double-click row selection to view environmental data. Click on column heading to sort table.

All Active Stored Pending

View Freeze Frame View Event Data

	ECU	Code	Status	Description
	ORC	B0028-13	Active	Right Side Seat Deployment Squib 1-Circuit Open

Overview

Name:
Occupant Restraint
Flash Part Number:
68105510AD
Bus Type:
CAN C
Hardware Version:
0B.0B.00
Software Version:
#0: 11.11.00, #1: 11.28.18, #2: 00.00.00
Spare Part Number:
Not Available
ISO Code:

Software Number:
Not Available
Hardware Number:
Not Available
Original VIN

Disconnect Warnings: 0 Errors: 0
12:52 PM
1/6/2014





ORC View

Click on tabs to access various ECU operations and information for the selected ECU.

Search Service Information Enter search phrase here

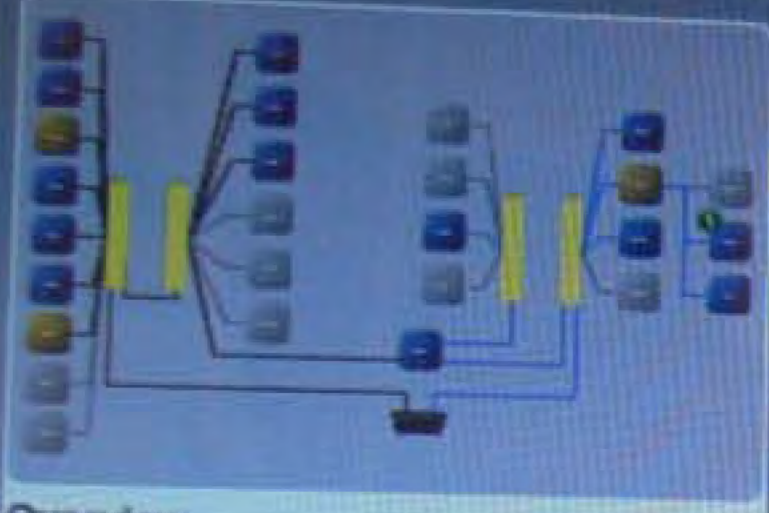

Overview

Name:
Occupant Restraint

Flash Part Number:
681D5510AD

Bus Type:
CAN C

Hardware Version:
0B.0B.00

Software Version:
#0: 11.11.00, #1: 11.28.18, #2: 00.00.00

Spare Part Number:
Not Available

ISO Code:

Software Number:
Not Available

Hardware Number:
Not Available

Original VIN

- Flash
- Data
- DTCs**
- Actuators
- System Tests
- Misc Functions
- ECU Details

Double-click row selection to view environmental data. Click on column heading to sort table.

All | Active | Stored | Pending

ECU	Code	Status	Description
ORC	B0028-13	Active	Right Side Seat Deployment Squib 1-Circuit Open

View Freeze Frame | View Event Data | Clear Stored DTCs

Click on the buttons to view the desired information. Click on column heading to sort table.

Environmental Data for ORC | B0028-13 Right Side Seat Deployment Squib 1-Circuit Open

Name	Value	Units
Test Failed	True	
Test Failed This Operation Cycle	False	
Pending DTC	False	
Confirmed DTC	True	
Test Not Completed Since Last Clear	False	
Test Failed Since Last Clear	False	

(1) New knowledge base articles

Online

ERAccess - R7CPY...

Disconnected

Warnings: 0 Errors: 0

12:33 PM
1/6/2014



Click on tabs to access various ECU operations and information for the selected ECU.

Search Service Information

- Flash
- Data
- DTCs**
- Actuators
- System Tests
- Misc Functions
- ECU Details

Double-click row selection to view environmental data. Click on column heading to sort table.

All | Active | Stored | Pending

ECU	Code	Status	Description
ORC	B0028-13	Active	Right Side Seat Deployment Squib 1-Circuit Open

Click on the buttons to view the desired information. Click on column heading to sort table.

Environmental Data for ORC | B0028-13 Right Side Seat Deployment Squib 1-Circuit Open

Name	Value	Units
Test Not Completed This Operation Cycle	False	
Warning Indicator Requested	True	
DTC Extended Data Record Number - All	01	
Occurrence flag	Error	
Original Odometer Value	58359	miles
Most Recent Odometer Value	58816	miles

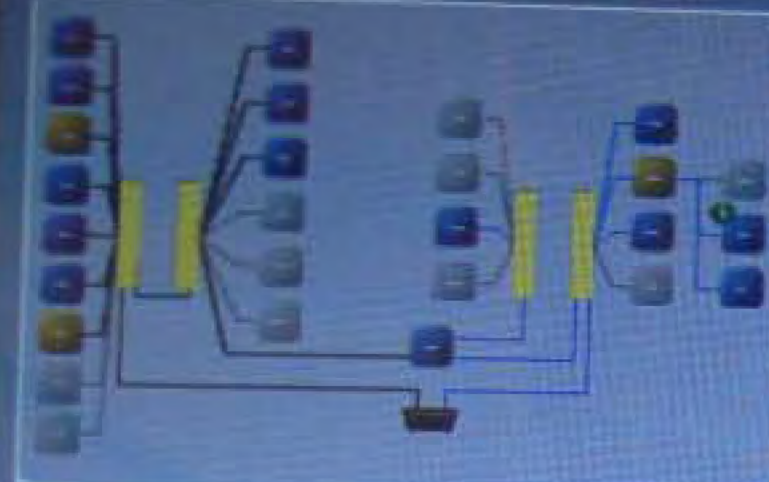

Overview

Name: Occupant Restraint
Flash Part Number: 68105510AD
Bus Type: CAN C
Hardware Version: 0B.0B.00
Software Version: #0: 11.11.00, #1: 11.28.1B, #2: 00.00.00
Spare Part Number: Not Available
ISO Code:
Software Number: Not Available
Hardware Number: Not Available
Original VIN

(1) New knowledge base articles

Online

ERAccess - R7CPY...

Disconnect

Warnings: 0 Errors

12:33 PM
1/6/2011





ORC View

Click on tabs to access various ECU operations and information for the selected ECU.

Search Service Information Enter search phrase here

- Flash
- Data
- DTCs**
- Actuators
- System Tests
- Misc Functions
- ECU Details

Double-click row selection to view environmental data. Click on column heading to sort table.

All | Active | Stored | Pending

ECU	Code	Status	Description
ORC	B0028-13	Active	Right Side Seat Deployment Squib 1-Circuit Open

View Freeze Frame | View Event Data | Clear Stored DTCs

Click on the buttons to view the desired information. Click on column heading to sort table.

Environmental Data for ORC | B0028-13 Right Side Seat Deployment Squib 1-Circuit Open

Environmental Data | Snapshot Data

Name	Value	Units
Occurrence flag	Error	
Original Odometer Value	58359	miles
Most Recent Odometer Value	58816	miles
Frequency Counter	15	
Operation Cycle Counter	Operation Cycle Counter not available / Default	
Accumulation Timer	461	minutes

Overview

Name:
Occupant Restraint

Flash Part Number:
68105510AD

Bus Type:
CAN C

Hardware Version:
0B.0B.00

Software Version:
#0: 11.11.00, #1: 11.28.18, #2: 00.00.00

Spare Part Number:
Not Available

ISO Code:

Software Number:
Not Available

Hardware Number:
Not Available

Original VIN

(1) New knowledge base articles

Online

ERAccess - R7CPY...

Disconnect

Warnings: 0 Errors

12:34
1/5/2014



14.01.20



TGW View

Click on tabs to access various ECU operations and information for the selected ECU.

Search Service Information

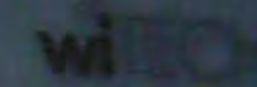

- Flash
- Data
- DTCs**
- Actuators
- System Tests
- Misc Functions
- ECU Details

Double-click row selection to view environmental data. Click on column heading to sort table.

All Active Stored Pending

- View Freeze Frame
- View Event Data
- Clear Stored DTCs

	ECU	Code	Status	Description
	TGW	B156B-2B	Stored	Satellite Radio Antenna-Wires Shorted Together
	TGW	B1572-00	Stored	CD/DVD Read Error - Inoperable Disc-

Overview

Name:

Telematic Gateway Radio

Flash Part Number:

05091103AB

Bus Type:

CAN IHS

Hardware Version:

30.30.30

Software Version:

#0: 11.31.07, #1: 11.31.07

Spare Part Number:

Not Available

ISO Code:**Software Number:**

Not Available

Hardware Number:

Not Available

Original VIN

2C3CCAAG5CH [REDACTED]

Disconnect Warnings: 0 Errors: 0

12:34 PM 1/6/2014

(1) New knowledge base articles

Online

ERAccess - R7CPY...

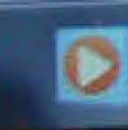

wi 14.01.20





TGW View

Click on tabs to access various ECU operations and information for the selected ECU.

Search Service Information

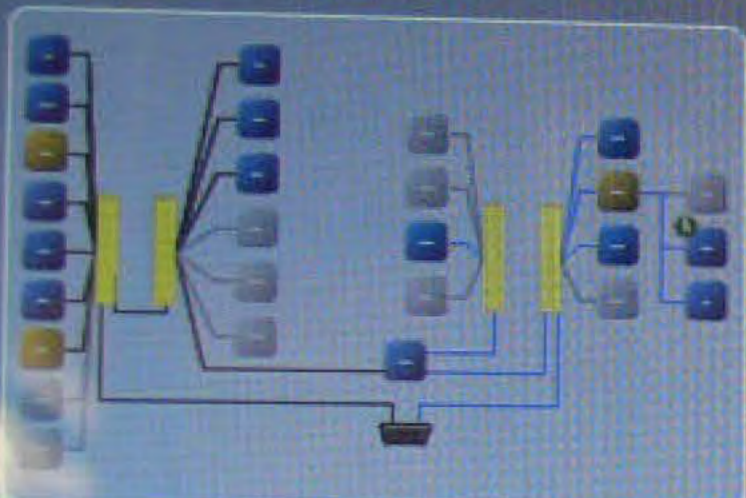

- Flash
- Data
- DTCs**
- Actuators
- System Tests
- Misc Functions
- ECU Details

Double-click row selection to view environmental data. Click on column heading to sort table.

All | Active | Stored | Pending

- View Freeze Frame
- View Event Data
- Clear Stored DTCs

ECU	Code	Status	Description
TGW	B156B-2B	Stored	Satellite Radio Antenna-Wires Shorted Together
TGW	B1572-00	Stored	CD/DVD Read Error - Inoperable Disc-

Overview

Name: Telematic Gateway Radio
Flash Part Number: 05091103AB
Bus Type: CAN IHS
Hardware Version: 30.30.30
Software Version: #0: 11.31.07, #1: 11.31.07
Spare Part Number: Not Available
ISO Code:
Software Number: Not Available
Hardware Number: Not Available
Original VIN: 2C3CCAAG5CH [REDACTED]

Click on the buttons to view the desired information. Click on column heading to sort table.

- Environmental Data
- Snapshot Data

Environmental Data for TGW | B156B-2B Satellite Radio Antenna-Wires Shorted Together

Name	Value	Units
Test Failed	False	
Test Failed This Operation Cycle	False	
Pending DTC	False	
Confirmed DTC	True	
Test Not Completed Since Last Clear	False	
Test Failed Since Last Clear	True	

(1) New knowledge base articles

Online

ERAccess - R7CPY...

wi 14.01.20

Disconnect

Warnings: 0 Errors: 0

12:35 PM
1/6/2014





TGW View

Click on tabs to access various ECU operations and information for the selected ECU.

- Flash
- Data
- DTCs**
- Actuators
- System Tests
- Misc Functions
- ECU Details

Double-click row selection to view environmental data. Click on column heading to sort table.

All | Active | Stored | Pending

- View Freeze Frame
- View Event Data
- Clear Stor

ECU	Code	Status	Description
TGW	B156B-2B	Stored	Satellite Radio Antenna-Wires Shorted Together
TGW	B1572-00	Stored	CD/DVD Read Error - Inoperable Disc-

Click on the buttons to view the desired information. Click on column heading to sort table.

Environmental Data

Environmental Data for TGW | B156B-2B Satellite Radio Antenna-Wires Shorted Together

Name	Value	Units
Test Not Completed This Operation Cycle	False	
Warning Indicator Requested	False	
DTC Extended Data Record Number - All	01	
Occurrence flag	Error	miles
Original Odometer Value	57365	miles
Most Recent Odometer Value	58787	

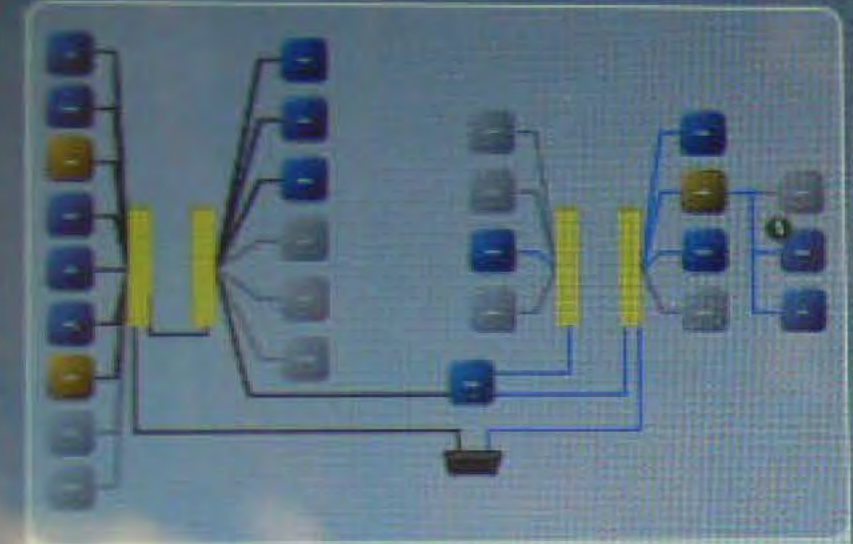

Overview

Name: Telematic Gateway Radio

Flash Part Number: 05091103AB

Bus Type: CAN IHS

Hardware Version: 30.30.30

Software Version: #0: 11.31.07, #1: 11.31.07

Spare Part Number: Not Available

ISO Code:

Software Number: Not Available

Hardware Number: Not Available

Original VIN: 2C3CCAAG5C [REDACTED]

(1) New knowledge base articles

Online

ERAccess - R7CPY...

Windows taskbar with icons for Start, Internet Explorer, and Wi-Fi. System tray shows date 14.01.20.





TGW View

Click on tabs to access various ECU operations and information for the selected ECU.

Search Service Information

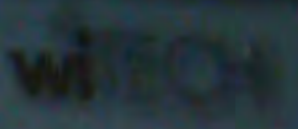

- Flash
- Data
- DTCs**
- Actuators
- System Tests
- Misc Functions
- ECU Details

Double-click row selection to view environmental data. Click on column heading to sort table.

All | Active | Stored | Pending

- View Freeze Frame
- View Event Data
- Clear Stored DTCs

ECU	Code	Status	Description
TGW	B156B-2B	Stored	Satellite Radio Antenna-Wires Shorted Together
TGW	B1572-00	Stored	CD/DVD Read Error - Inoperable Disc-

A A

Click on the buttons to view the desired information. Click on column heading to sort table.

- Environmental Data
- Snapshot Data

Environmental Data for TGW | B1572-00 CD/DVD Read Error - Inoperable Disc-

Name	Value	Units
Test Failed	False	
Test Failed This Operation Cycle	False	
Pending DTC	False	
Confirmed DTC	True	
Test Not Completed Since Last Clear	False	
Test Failed Since Last Clear	True	

Overview

Name:
Telematic Gateway Radio

Flash Part Number:
05091103AB

Bus Type:
CAN IHS

Hardware Version:
30.30.30

Software Version:
#0: 11.31.07, #1: 11.31.07

Spare Part Number:
Not Available

ISO Code:

Software Number:
Not Available

Hardware Number:
Not Available

Original VIN
2C3CCAAG5CH

(1) New knowledge base articles

Online

ERAccess - R7CPY...

wi 14.01.20

Disconnect

Warnings: 0 Errors

12:36 PM

1/6/2014





TGW View

Click on tabs to access various ECU operations and Information for the selected ECU.

Search Service Information

- Flash
- Data
- DTCs**
- Actuators
- System Tests
- Misc Functions
- ECU Details

Double-click row selection to view environmental data. Click on column heading to sort table.

All | Active | Stored | Pending

- View Freeze Frame
- View Event Data
- Clear Stored DTCs

ECU	Code	Status	Description
TGW	B156B-2B	Stored	Satellite Radio Antenna-Wires Shorted Together
TGW	B1572-00	Stored	CD/DVD Read Error - Inoperable Disc-

Click on the buttons to view the desired information. Click on column heading to sort table.

- Environmental Data
- Snapshot Data

Environmental Data for TGW | B1572-00 CD/DVD Read Error - Inoperable Disc-

Name	Value	Units
Test Not Completed This Operation Cycle	False	
Warning Indicator Requested	False	
DTC Extended Data Record Number - All	01	
Occurrence flag	Error	miles
Original Odometer Value	57365	miles
Most Recent Odometer Value	58787	

Overview

Name: Telematic Gateway Radio
Flash Part Number: 05091103AB
Bus Type: CAN IHS
Hardware Version: 30.30.30
Software Version: #0: 11.31.07, #1: 11.31.07
Spare Part Number: Not Available
ISO Code:
Software Number: Not Available
Hardware Number: Not Available
Original VIN: 2C3CCAAG5CH

(1) New knowledge base articles

Online

ERAccess - R7CPY...

wi 14.01.20

Disconnect Warnings: 0 Errors: 0 12:36 PM 1/6/2014



MFD BY CHRYSLER GROUP LLC

GUAR: 02314 KG

GUAR: 01275 KG

DATE OF MFR: 10-11

05100 LB

FRONT: 02810 LB

REAR: 02810 LB

THIS VEHICLE CONFORMS TO ALL APPLICABLE U.S.A. FEDERAL MOTOR VEHICLE SAFETY,
BUMPER AND THEFT PREVENTION STANDARDS IN EFFECT ON
THE DATE OF MANUFACTURE SHOWN ABOVE.



VIN: 2C3CCAG5C1

MDH: 102714 664AA

PAINT: PMH

TYPE: PASSENGER CAR
TRIM: 05X9

VEHICLE MADE IN CANADA

4658843

P
R
N
D/L

N 58820mi 69°

Press Brake and
Push Button to Shift
into Gear



P
R
N
D
L



BRAKE





P
R
N
D/L

N 58820mi 69°

Audio OFF

▶ Fuel Economy

Vehicle Speed

Trip Info



P
R
N
D
L



BRAKE

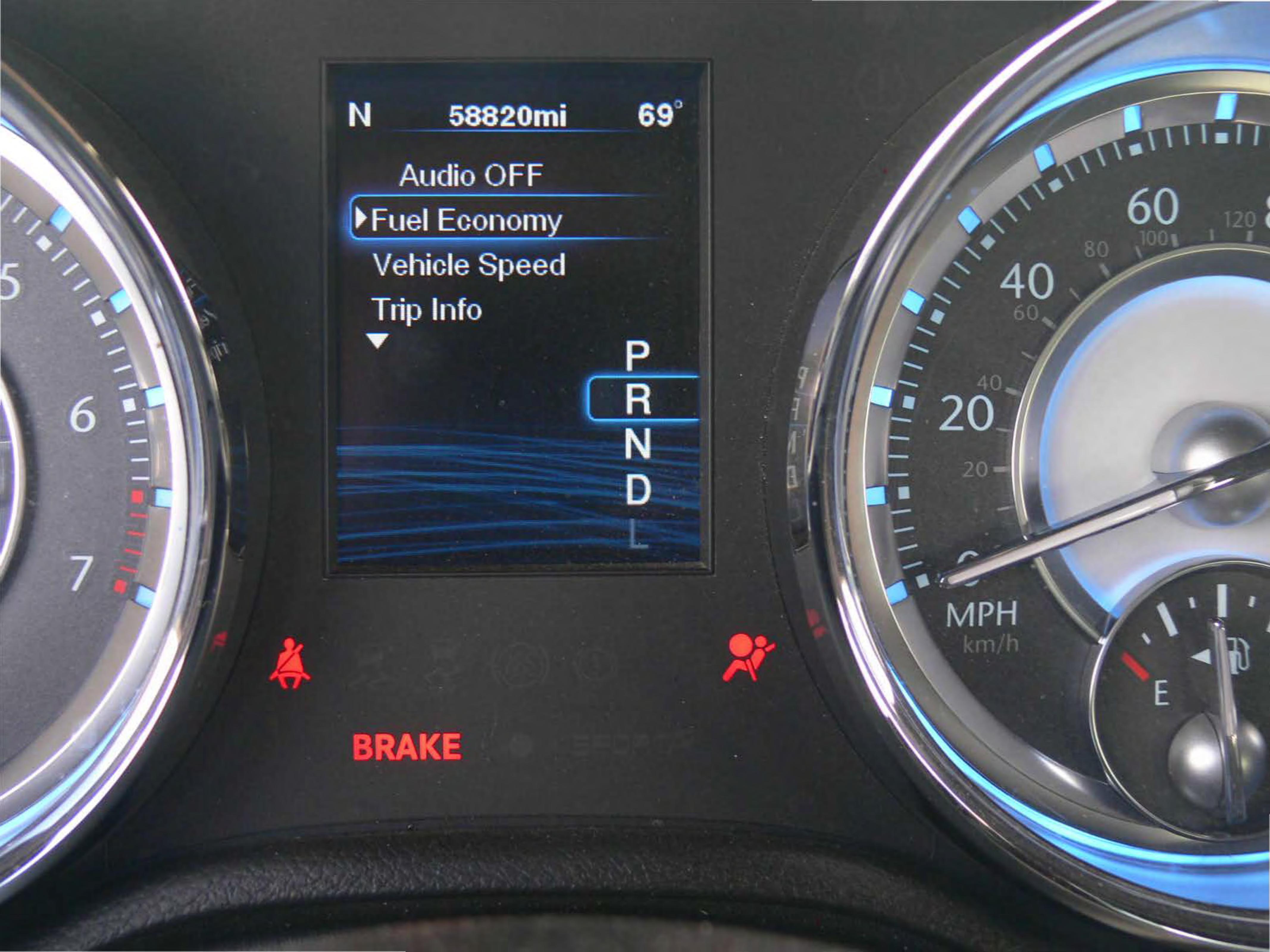

P
R
N
D/L