

EA16-002

FLAT CHRYSLER

5-12-2016

ENCLOSURE 04

CAIR Backup







































Vehicle View

Click over an ECU to see full name. Click on an ECU for complete details.

- 6L
- CACGXCH
- 11.67 miles
- ECU
- responsive ECU
- Present
- Not Built
- Planning ECU
- Flash Available
- N-C
- N-IHS

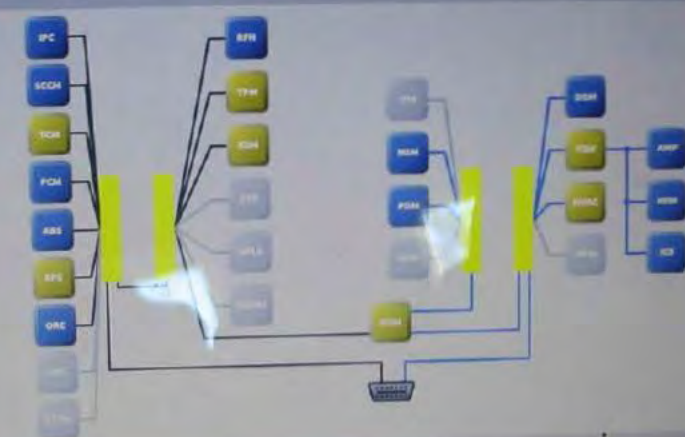

Click row selection to view environmental data. Click on column heading to sort table.

Active Stored Pending

ECU	Code	Status	Description
TCM	P1DC7-00	Stored	Clutch Temp Threshold Achieved - Shift Time Reduction
TCM	P1DC9-00	Stored	Clutch Temp Threshold Achieved - Skip Shift Down Inhibit
ECM	P1009-00	Stored	Multiple SAE Codes Modules

14.01.20

Utilities Reports Monitors Preferences About Help



Vehicle View

Roll over an ECU to see full name. Click on an ECU for complete details.

Search Service Information

Wi

2012 LX 3.6L
VIN: 2C3CCACGXG

11.17 miles

Legend

- Active ECU
- Non-responsive ECU
- DTCs Present

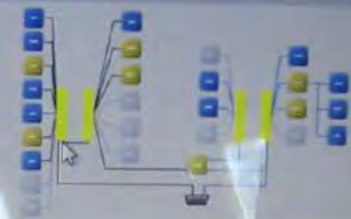

All DTCs Diagnostic Procedures Customer Preferences Vehicle Preparations

Double-click row selection to view environmental data. Click on column heading to sort table.

All Active Stored Pending

View Freeze Frame View Event Data Clear DTCs

ECU	Code	Status	Description
TCM	P1DC7-00	Stored	Clutch Temp Threshold Achieved - Shift Time Reduction
TCM	P1DC9-00	Stored	Clutch Temp Threshold Achieved - Skip Shift Down Inhibit
BCM	P1009-00	Stored	Humidity Sensor Module
EPS	U0415-00	Stored	Implausible Data Received from ABS
ESM	U1175-00	Stored	Lost Ignition Status Message
TPM	C0077-00	Active	Low Tire Pressure
HVAC	B160F-15	Stored	Twilight/Ambient Light Sensor input Circuit Short to Battery or Open
TOW	B1570-00	Stored	USB Communication

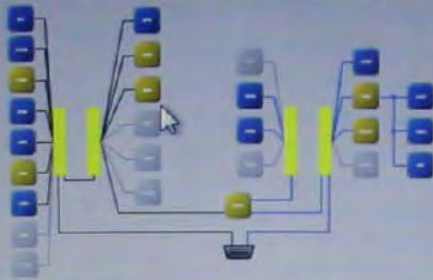

ences **Vehicle Preparations**

Click on the buttons to view the desired information. Click on column heading to sort table.

Environmental Data Snapshot Data

Environmental Data for TCM | P1DC7-00 Clutch Temp Threshold Achieved - Shift Time Reduction-

Name	Value	Units
Test Failed	False	
Test Failed This Operation Cycle	False	
Pending DTC	False	
Confirmed DTC	True	
Test Not Completed Since Last Clear	False	
Test Failed Since Last Clear	True	
Test Not Completed This Operation C	True	

Disconnect Warning's Emere

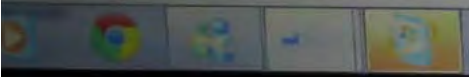

2:33 PM
1/3/2014

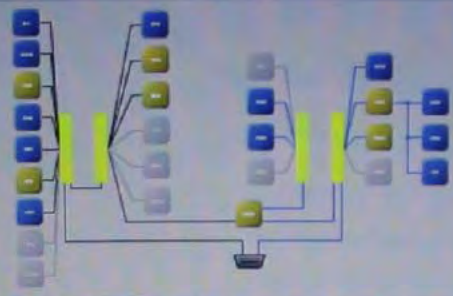

References **Vehicle Preparations**

Click on the buttons to view the desired information. Click on column heading to sort table.

Environmental Data Snapshot Data

Environmental Data for TCM | P1DC7-00 Clutch Temp Threshold Achieved - Shift Time Reduction-

Name	Value	Units
Warning Indicator Requested	False	
DTC Extended Data Record Number -	01	
Occurrence flag	Error	
Original Odometer Value	52102	miles
Most Recent Odometer Value	53458	miles
Frequency Counter	67	
Ignition Cycle Counter	1	

Disconnect Settings, 1 Error

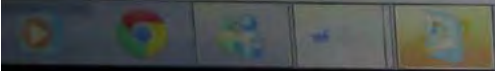

Click on the buttons to view the desired information. Click on column heading to sort table.

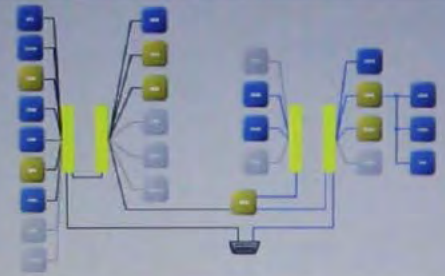

References Vehicle Preparations

Click on the buttons to view the desired information. Click on column heading to sort table.

Environmental Data Snapshot Data

Environmental Data for TCM | P1DC9-00 Clutch Temp Threshold Achieved - Skip Shift Down Inhibit-

Name	Value	Units
Test Failed	False	
Test Failed This Operation Cycle	False	
Pending DTC	False	
Confirmed DTC	True	
Test Not Completed Since Last Clear	False	
Test Failed Since Last Clear	True	
Test Not Completed This Operation C	True	

Disconnected Warnings & Errors

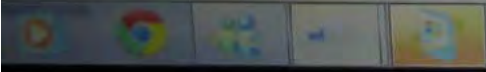

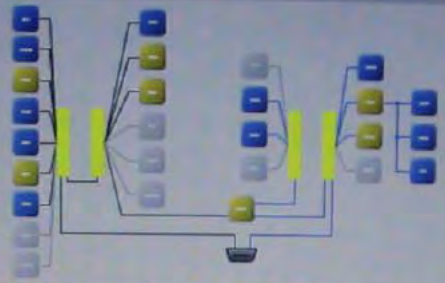

References **Vehicle Preparations**

Click on Click on the buttons to view the desired information. Click on column heading to sort table.

Environmental Data for TCM | P1DC9-00 Clutch Temp Threshold Achieved - Skip Shift Down Inhibit-

Name	Value	Units
Warning Indicator Requested	False	
DTC Extended Data Record Number -	01	
Occurrence flag	Error	
Original Odometer Value	36976	miles
Most Recent Odometer Value	53322	miles
Frequency Counter	18	
Ignition Cycle Counter	3	



2:33 PM
1/3/2014

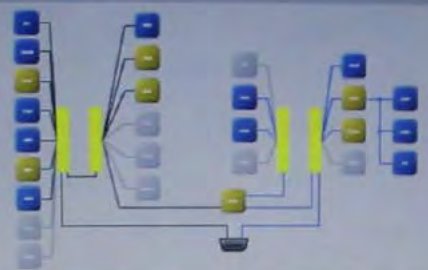

References Vehicle Preparations

Click on the buttons to view the desired information. Click on column heading to sort table.

Environmental Data Snapshot Data

Environmental Data for BCM | P1009-00 Humidity Sensor Module-

Name	Value	Units
Test Failed	False	
Test Failed This Operation Cycle	False	
Pending DTC	False	
Confirmed DTC	True	
Test Not Completed Since Last Clear	False	
Test Failed Since Last Clear	True	
Test Not Completed This Operation C	False	

Disconnect

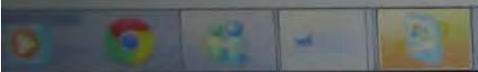

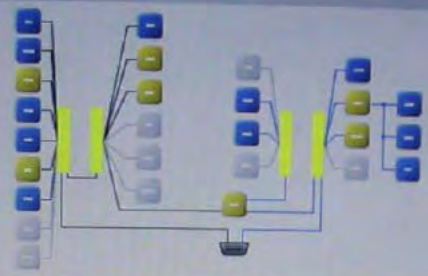

References **Vehicle Preparations**

Click on the buttons to view the desired information. Click on column heading to sort table.

Environmental Data Snapshot Data

Environmental Data for BCM | P1009-00 Humidity Sensor Module-

Name	Value	Units
Warning Indicator Requested	False	
DTC Extended Data Record Number -	01	
Occurrence flag	Error	
Original Odometer Value	53478	miles
Most Recent Odometer Value	53478	miles
Frequency Counter	1	
Ignition Cycle Counter	2	

Disconnect Warnings: 0 Errors: 0

View

Access various ECU operations and information for the selected ECU.



- Flash
- Data
- DTCs**
- Actuators
- System Tests
- Misc Functions
- ECU Details

Double-click row selection to view environmental data. Click on column heading to sort table.

All Active Stored Pending

- View Freeze Frame
- View Event Data
- Clear Stored DTCs

	ECU	Code	Status	Description
<input checked="" type="checkbox"/>	TCM	P1DC7-00	Stored	Clutch Temp Threshold Achieved - Shift Time Reduction-
	TCM	P1DC9-00	Stored	Clutch Temp Threshold Achieved - Skip Shift Down Inhibit-



TCM View

Click on tabs to access various



Overview

Name:

Transmission Control Module

Flash Part Number:

68046526AL

Bus Type:

CAN C

Hardware Version:

0A.03.1F

Software Version:

#0: 12.26.00, #1: 12.26.00

Spare Part Number:

Not Available

ISO Code:

Software Number:

Not Available

Hardware Number:

Not Available

Original VIN

Flash

Double-click

AP Ac





P
R
N
D/L

Porsche

000

00

NE 53480mi 36°

Press Brake and
Push Button to Shift
into Gear



P
R
N
D



Information for the selected ECU.

Parameters System Tests Misc Functions ECU Details

Click on a graph data element, or check multiple elements and press "Show Graph". Click on column heading to sort table. Drag and drop row or multiple row selections to re-

Show Graph

Name	Value	Unit	Type
Low TRANS Torque Request	True		Sensors
Cruise System is Controlling Speed	False		Sensors
Brake Pedal State	Pedal Upstopped		Sensors
Brake Intervention by ESP Active	False		Sensors
Brake Intervention by assistance system active	False		Sensors
Master cylinder pressure	0	psi	Sensors
Wheel RPM Front Left	0.0	rpm	Sensors
Wheel RPM Front Right	0.0	rpm	Sensors
Wheel RPM Rear Left	0.0	rpm	Sensors
Wheel RPM Rear Right	0.0	rpm	Sensors
Transfer Case Status	Shift in Progress		Sensors
Oil Temperature	115	F	Sensors
Current Gear	Current Gear "P"		Sensors
Trans A/C Converter Clutch Slipping	False		Sensors





for the selected ECU.

System Tests Misc Functions ECU Details

element, or check multiple elements and press "Show Graph". Click on column heading to sort table. Drag and drop row or multiple row selections to re-

Show Graph

	Value	Unit	Type
Power Supply Of Valves	14.158	V	Sensors
AS Torque Request	True		Sensors
em Is Controlling Speed	False		Sensors
al State	Pedal Pressed		Sensors
ervention by ESP Active	False		Sensors
ervention by assistance system active	False		Sensors
linder pressure	1094	psi	Sensors
M Front Left	0.0	rpm	Sensors
M Front Right	0.0	rpm	Sensors
M Rear Left	0.0	rpm	Sensors
M Rear Right	Shift in Progress		Sensors
Case Status	183	F	Sensors
emperature			
Gear	Current Gear "R"		

Download





NE 53480mi 36°
Press Brake and
Push Button to Shift
into Gear



A diagram of a shift button with a red outline and a blue center. Below it is a blue rectangular button with the letter 'i' on it.

P
R
N
D



00
00



Operations and information for the selected ECU.

- DTCs**
- Actuators**
- System Tests**
- Misc Functions**
- ECU Details**

Click row selection to graph data element, or check multiple elements and press "Show Graph". Click on column heading to sort table. Drag and drop row or multiple row selections to re-arrange elements.

Show Graph

	Name	Value	Unit	Type
<input type="checkbox"/>	Voltage Power Supply Of Valves	14.151	V	Sensors
<input type="checkbox"/>	Allow TRANS Torque Request	True		Sensors
<input type="checkbox"/>	Cruise System Is Controlling Speed	False		Sensors
<input type="checkbox"/>	Brake Pedal State	Pedal Pressed		Sensors
<input type="checkbox"/>	Brake Intervention by ESP Active	False		Sensors
<input type="checkbox"/>	Brake Intervention by assistance system active	False	psi	Sensors
<input type="checkbox"/>	Master cylinder pressure	1111	rpm	Sensors
<input type="checkbox"/>	Wheel RPM Front Left	0.0	rpm	Sensors
<input type="checkbox"/>	Wheel RPM Front Right	0.0	rpm	Sensors
<input type="checkbox"/>	Wheel RPM Rear Left	0.0	rpm	Sensors
<input type="checkbox"/>	Wheel RPM Rear Right	0.0	rpm	Sensors
<input type="checkbox"/>	Transfer Case Status	Shift in Progress		Sensors
<input type="checkbox"/>	Oil Temperature	187	F	Sensors
<input type="checkbox"/>	Current Gear	Current gear "N"		Sensors

Show Graph

Disconnect

2:54 PM 1/3/2014



acer





operations and information for the selected ECU.

- DTCs
- Actuators
- System Tests
- Misc Functions
- ECU Details

Click row selection to graph data element, or check multiple elements and press "Show Graph". Click on column heading to sort table. Drag and drop row or multiple row selections to the elements.

	Name	Value	Unit	Type
<input type="checkbox"/>	Voltage Power Supply Of Valves	14.22	V	Sensors
<input type="checkbox"/>	Allow TRANS Torque Request	True		Sensors
<input type="checkbox"/>	Cruise System Is Controlling Speed	False		Sensors
<input type="checkbox"/>	Brake Pedal State	Pedal Pressed		Sensors
<input type="checkbox"/>	Brake Intervention by ESP Active	False		Sensors
<input type="checkbox"/>	Brake Intervention by assistance system active	False	psi	Sensors
<input type="checkbox"/>	Master cylinder pressure	1146	rpm	Sensors
<input type="checkbox"/>	Wheel RPM Front Left	0.0	rpm	Sensors
<input type="checkbox"/>	Wheel RPM Front Right	0.0	rpm	Sensors
<input type="checkbox"/>	Wheel RPM Rear Left	0.0	rpm	Sensors
<input type="checkbox"/>	Wheel RPM Rear Right	0.0	rpm	Sensors
<input type="checkbox"/>	Transfer Case Status	Shift in Progress	F	Sensors
<input type="checkbox"/>	Oil Temperature	189		Sensors
<input type="checkbox"/>	Current Gear "1"			Sensors







NE 53480mi 36°

Tire Pressure

30	30
9	29

LOW PSI

i

P
R
N
D
i



Configure ECU operations and information for the selected ECU.

- Graph
- Data
- DTG
- Actuators
- System Tests
- RMS Functions
- ECU Outputs

Disable ECU row selection to graph data element, or check multiple elements and press "Show Graph". Edit an element's settings in the table. To get more information on the elements, enter table elements.

Graph	Name	Value	Unit	Type
<input type="checkbox"/>	Voltage Power Supply (V) Value	14.75	V	Value
<input type="checkbox"/>	Allow TRMS Circuit Request	True		Boolean
<input type="checkbox"/>	Cruise System is Controlling Clutch	True		Boolean
<input type="checkbox"/>	Brake Pedal State	pedal pressed		Boolean
<input type="checkbox"/>	Brake Intervention by ESP Active	True		Boolean
<input type="checkbox"/>	Brake Intervention by ABS/ESC System Active	True		Boolean
<input type="checkbox"/>	Water Cylinder Pressure	0.0	bar	Value
<input type="checkbox"/>	Wheel RPM Front Left	0.0	rpm	Value
<input type="checkbox"/>	Wheel RPM Front Right	0.0	rpm	Value
<input type="checkbox"/>	Wheel RPM Rear Left	0.0	rpm	Value
<input type="checkbox"/>	Wheel RPM Rear Right	0.0	rpm	Value
<input type="checkbox"/>	Transfer Case Status	ESP is engaged		Boolean
<input type="checkbox"/>	ECU Temperature	90		Value
<input type="checkbox"/>	Control Gear			Value

MFD BY CHRYSLER GROUP LLC

DATE OF MFR: 11-11

GWR: 82014 KG

GWR: 81275 KG

GWR: 81275 KG

25100 LB

FRONT: 82818 LB

REAR: 82818 LB

THIS VEHICLE CONFORMS TO ALL APPLICABLE U.S.A. FEDERAL MOTOR VEHICLE SAFETY
CRITERIA AND THEIR PRECEDENT STANDARDS IN EFFECT ON
THE DATE OF MANUFACTURE SHOWN ABOVE.



VIN: 2C3CC0C62C

YR: 110818 0028H

VEHICLE MADE IN CANADA

PLANT: RRV

TYPE: PASSENGER CAR

3RM-TLX

WAS000001

2C3CCACGXCH [REDACTED]

E

53480mi

36°

Press Brake and
Push Button to Shift
into Gear



P
R
N















an ECU for complete details.

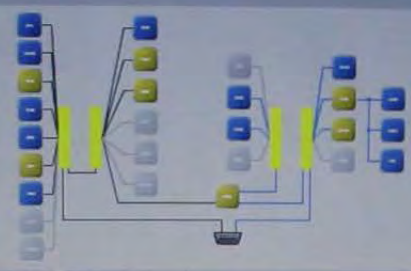

Click on the buttons to view the desired information. Click on column heading to sort table.

Environmental Data Snapshot Data

Environmental Data for EPS | U0415-00 Implausible Data Received from ABS-

Name	Value	Units
Test Failed	False	
Test Failed This Operation Cycle	False	
Pending DTC	False	
Confirmed DTC	True	
Test Not Completed Since Last Clear	False	
Test Failed Since Last Clear	True	
Test Not Completed This Operation C	False	

Downloaded Messages & Errors

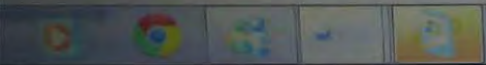

on an ECU for complete details.

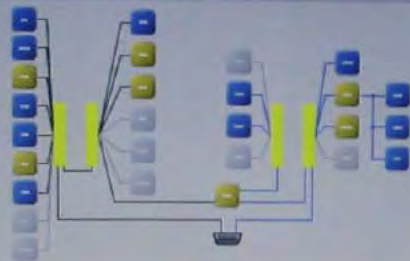

data. Click on Click on the buttons to view the desired information. Click on column heading to sort table.

Environmental Data for EPS | U0415-00 Implausible Data Received from ABS-

Name	Value	Units
Test Not Completed This Operation C	False	
Warning Indicator Requested	False	
Occurrence flag	Error	
Original Odometer Value	48049	miles
Most Recent Odometer Value	48049	miles
Frequency Counter	1	
Ignition Cycle Counter	3	

ECU for complete details.

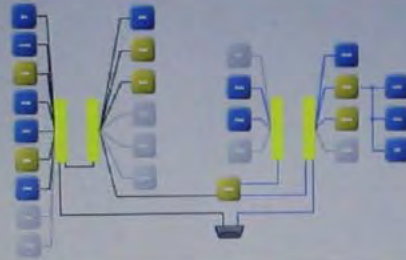

Vehicle Preparations

Click on the buttons to view the desired information. Click on column heading to sort table.

Environmental Data Snapshot Data

Environmental Data for ESM | U1175-00 Lost Ignition Status Message-

Name	Value	Units
Test Failed	False	
Test Failed This Operation Cycle	False	
Pending DTC	False	
Confirmed DTC	True	
Test Not Completed Since Last Clear	False	
Test Failed Since Last Clear	True	
Test Not Completed This Operation C	False	

Download

Warnings & Errors

for complete details.

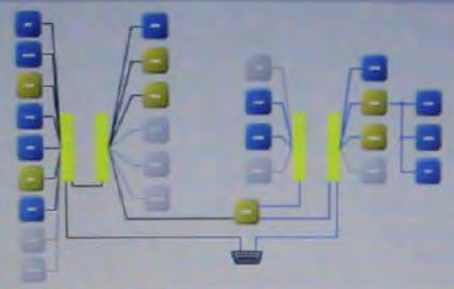

ences **Vehicle Preparations**

Click on the buttons to view the desired information. Click on column heading to sort table.

Environmental Data Snapshot Data

Environmental Data for ESM | U1175-00 Lost Ignition Status Message-

Name	Value	Units
Most Recent Odometer Value	53478	miles
Frequency Counter	255	
Ignition Cycle Counter	2	
Ignition Status	Ignition Lock	
Operating Voltage	12.7	Volts
Sub-Faults Saved	00 00	
Sub-Faults Active	00 00	

Disconnect

2:35 PM
1/3/2014

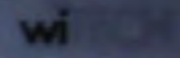

in ECU for complete details.

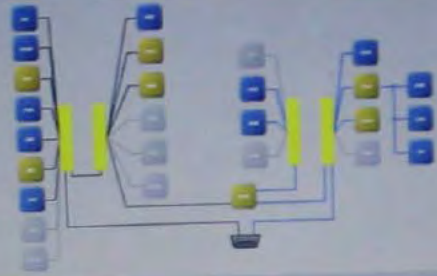

Click on

Click on the buttons to view the desired information. Click on column heading to sort table.

Environmental Data for TPM | C0077-00 Low Tire Pressure-

Name	Value	Units
Test Failed	True	
Test Failed This Operation Cycle	False	
Pending DTC	False	
Confirmed DTC	True	
Test Not Completed Since Last Clear	False	
Test Failed Since Last Clear	False	
Test Not Completed This Operation C	False	

- Copy Frame
- Threshold Ach
- Threshold Ach
- ensor Module-
- Data Received
- on Status Messag
- Pressure-
- ambient Light Sen
- Information-

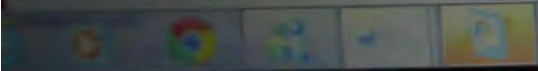

an ECU for complete details.

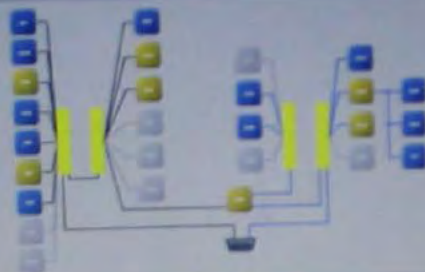

User Preferences Vehicle Preparations

data. Click on

Click on the buttons to view the desired information. Click on column heading to sort table.

Environmental Data Snapshot Data

Environmental Data for TPM | C0077-00 Low Tire Pressure-

Name	Value	Units
Warning Indicator Requested	False	
DTC Extended Data Record Number -	01	
Occurrence flag	Occurrence	
Original Odometer Value	50833	miles
Most Recent Odometer Value	52593	miles
Frequency Counter	4	
Operation Cycle Counter	0	

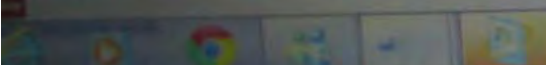

2:25 PM 1/10/2014

ECU for complete details.

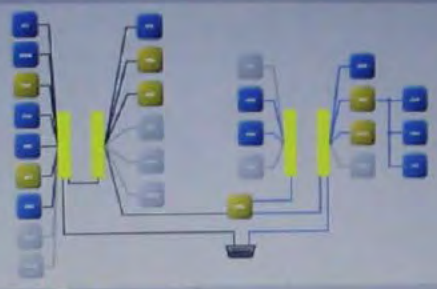

References Vehicle Preparations

Click on the buttons to view the desired information. Click on column heading to sort table.

Environmental Data Snapshot Data

Environmental Data for HVAC | B160F-15 Twilight/Ambient Light Sensor Input-Circuit Short to Battery or Open

Name	Value	Units
Test Failed	False	
Test Failed This Operation Cycle	False	
Pending DTC	False	
Confirmed DTC	True	
Test Not Completed Since Last Clear	False	
Test Failed Since Last Clear	True	
Test Not Completed This Operation C	False	

- Threshold Ach
- Threshold Ach
- or Module-
- ata Received f
- Status Messag
- ssure-
- mbient Light Sen
- onication-

Download

2:36 PM
1/3/2014

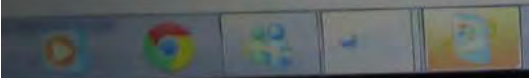

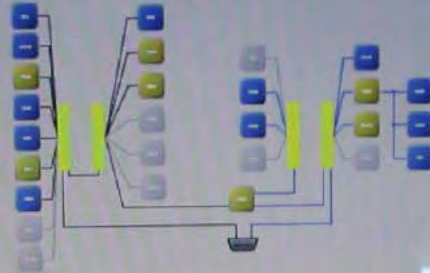

Vehicle Preparations

Click on the buttons to view the desired information. Click on column heading to sort table.

Environmental Data Snapshot Data

Environmental Data for HVAC | B160F-15 Twilight/Ambient Light Sensor Input-Circuit Short to Battery or Open

Name	Value	Units
Test Not Completed This Operation C	False	
Warning Indicator Requested	False	
Occurrence flag	Error	
Original Odometer Value	26833	miles
Most Recent Odometer Value	53478	miles
Frequency Counter	102	
Ignition Cycle Counter	5	

Download

Warning: 1 Error(s)

complete details.

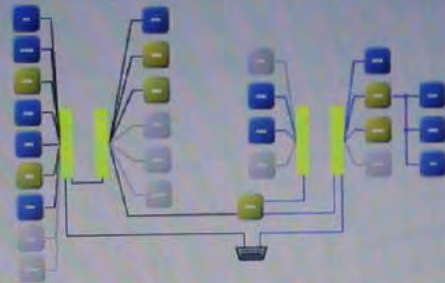

Vehicle Preparations

Click on the buttons to view the desired information. Click on column heading to sort table.

Environmental Data Snapshot Data

Environmental Data for TGW | B1570-00 USB Communication-

Name	Value	Units
Test Failed	False	
Test Failed This Operation Cycle	False	
Pending DTC	False	
Confirmed DTC	True	
Test Not Completed Since Last Clear	False	
Test Failed Since Last Clear	False	
Test Not Completed This Operation C	False	

Disconnected

2:37 PM 1/3/2014

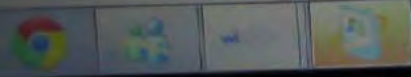

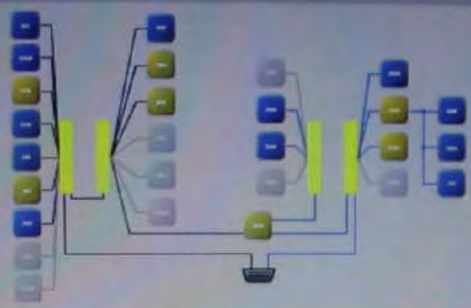

Vehicle Preparations

Click on the buttons to view the desired information. Click on column heading to sort table.

Environmental Data Snapshot Data

Environmental Data for TGW | B1570-00 USB Communication-

Name	Value	Units
Warning Indicator Requested	False	
DTC Extended Data Record Number -	01	
Occurrence flag	Occurrence	
Original Odometer Value	49700	miles
Most Recent Odometer Value	53478	miles
Frequency Counter	2	
Ignition Cycle Counter	2	

Disconnect Message

2:37 PM 1/3/2014

EA16-002

FLAT CHRYSLER

5-12-2016

ENCLOSURE 04

CAIR Backup





SPRING, TEXAS 7

FACSIMILE TRANSMITTAL SHEET

TO: Chrysler Customer Care FROM: [Redacted]

ORGANIZATION: Chrysler Corporation DATE: February 6, 2014

TOTAL NO. OF PAGES INCLUDING COVER: Three (3) Pages

PHONE NUMBER: [Redacted]

RE: Case Number [Redacted]

URGENT FOR REVIEW PLEASE COMMENT PLEASE REPLY PLEASE RECYCLE

NOTES/COMMENTS:

Please refer to the following letter citing my concerns about the safety of my vehicle.



CC: Mr. JASON DOUGLAS, GSM Tomball/Dodge
Mr. ANTHONY EHLERS, Service Consultant

[REDACTED]
[REDACTED]
Spring, TX [REDACTED]

February 6, 2014

Chrysler Customer Care
P.O. Box 21-8004
Auburn Hills, MI 48321-8004

Subject: Notification of Safety Concern – 2012 Chrysler 300

Reference: Case Number [REDACTED]

Confirming my discussions with Tomball Dodge (Anthony Ehlers) and Chrysler Customer Care (Shannon – Employee Number SR1255), earlier today, this letter is to notify you that I have a serious concern about the safety of my 2012 Chrysler.

I took my Chrysler to the dealership where I purchased it, with a concern about the gear shifter. It became stiff and was difficult to put it into gear. After several days, the dealership diagnosed the problem, I was informed by the Service Advisor, Mr. Anthony Ehlers, that the gear shifter would have to be replaced; however, unfortunately, it is on "Back-order".

He informed me that it was safe for me to drive the vehicle, until the part is received. I was out of the country for more than a week and when I returned home, I drove my car, for several days and noticed that it was very difficult for me to shift from Drive (D) to Park (P). It seemed to get stuck in Reverse (R). This is a serious safety issue and I am fearful that my vehicle may be subjected to an unfortunate crash, because of this faulty shifter.

The purpose for this letter is to place you on notice and inform you of this potentially dangerous situation. I suggest that Chrysler provide me with a replacement vehicle, without charge, until my current vehicle is repaired. I have been informed by Ms. Shannon, that the expected date of delivery for the part is April 4th, 2014. This is unacceptable, considering the potential danger that this shifter provides.

I want my concerns to be a matter of record, in the event that the defective shifter of my car is the cause of a crash due to this faulty gear shifter.

I will await your expeditious and favorable response to my concerns. Thank you, in advance, for your courtesies and consideration.

Sincerely,

A solid black rectangular redaction box covering the signature area.

Cc: Mr. Jason Douglas, GSM, Tomball Dodge
Mr. Anthony Ehlers, Service Advisor, Tomball Dodge



SPRING, TEXAS

FACSIMILE TRANSMITTAL SHEET

TO: Chrysler Customer Care

FROM:



ORGANIZATION:

Chrysler Corporation

DATE:

February 6, 2014

TOTAL NO. OF PAGES INCLUDING COVER:

Three (3) Pages



CASE Number



URGENT



FOR REVIEW



PLEASE COMMENT



PLEASE REPLY



PLEASE RECYCLE

NOTES/COMMENTS:

Please refer to the following letter citing my concerns about the safety of my vehicle.



CC: ✓ Mr. JASON DOUGLAS, GSM Tomball/Dodge
✓ Mr. ANTHONY EHLERS, Service Consultant

[REDACTED]
Spring, TX [REDACTED]

February 6, 2014

Chrysler Customer Care
P.O. Box 21-8004
Auburn Hills, MI 48321-8004

Subject: Notification of Safety Concern – 2012 Chrysler 300

Reference: Case Number [REDACTED]

Confirming my discussions with Tomball Dodge (Anthony Ehlers) and Chrysler Customer Care (Shannon – Employee Number SR1255), earlier today, this letter is to notify you that I have a serious concern about the safety of my 2012 Chrysler.

I took my Chrysler to the dealership where I purchased it, with a concern about the gear shifter. It became stiff and was difficult to put it into gear. After several days, the dealership diagnosed the problem, I was informed by the Service Advisor, Mr. Anthony Ehlers, that the gear shifter would have to be replaced; however, unfortunately, it is on "Back-order".

He informed me that it was safe for me to drive the vehicle, until the part is received. I was out of the country for more than a week and when I returned home, I drove my car, for several days and noticed that it was very difficult for me to shift from Drive (D) to Park (P). It seemed to get stuck in Reverse (R). This is a serious safety issue and I am fearful that my vehicle may be subjected to an unfortunate crash, because of this faulty shifter.

The purpose for this letter is to place you on notice and inform you of this potentially dangerous situation. I suggest that Chrysler provide me with a replacement vehicle, without charge, until my current vehicle is repaired. I have been informed by Ms. Shannon, that the expected date of delivery for the part is April 4th, 2014. This is unacceptable, considering the potential danger that this shifter provides.

I want my concerns to be a matter of record, in the event that the defective shifter of my car is the cause of a crash due to this faulty gear shifter.

I will await your expeditious and favorable response to my concerns. Thank you, in advance, for your courtesies and consideration.

Sincerely,

[REDACTED]

Cc: Mr. Jason Douglas, GSM, Tomball Dodge
Mr. Anthony Ehlers, Service Advisor, Tomball Dodge



SPRING, TEXAS

FACSIMILE TRANSMITTAL SHEET

TO: Chrysler Customer Care FROM: [Redacted]

ORGANIZATION: Chrysler Corporation DATE: February 6, 2014

TOTAL NO. OF PAGES INCLUDING COVER: Three (3) Pages

PHONE NUMBER: [Redacted]

RE: Case Number [Redacted]

URGENT FOR REVIEW PLEASE COMMENT PLEASE REPLY PLEASE RECYCLE

NOTES/COMMENTS:

Please refer to the following letter citing my concerns about the safety of my vehicle.



CC: Mr. JASON DOUGLAS, GSM Tomball/Dodge
Mr. ANTHONY Ehlers, Service Consultant

I will await your expeditious and favorable response to my concerns. Thank you, in advance, for your courtesies and consideration.

Sincerely,

A solid black rectangular redaction box covering the signature area.

Cc: Mr. Jason Douglas, GSM, Tomball Dodge
Mr. Anthony Ehlers, Service Advisor, Tomball Dodge



SPRING, TEXAS

FACSIMILE TRANSMITTAL SHEET

TO: Chrysler Customer Care FROM: [Redacted]

ORGANIZATION: Chrysler Corporation DATE: February 6, 2014

TOTAL NO. OF PAGES INCLUDING COVER: Three (3) Pages

RE: [Redacted]

CASE Number [Redacted]

URGENT FOR REVIEW PLEASE COMMENT PLEASE REPLY PLEASE RECYCLE

NOTES/COMMENTS:

Please refer to the following letter citing my concerns about the safety of my vehicle.



CC: ✓ Mr. JASON DOUGLAS, GSM Tomball Dodge
✓ Mr. ANTHONY EHLERS, Service Consultant

[REDACTED]
Spring, TX [REDACTED]

February 6, 2014

Chrysler Customer Care
P.O. Box 21-8004
Auburn Hills, MI 48321-8004

Subject: Notification of Safety Concern – 2012 Chrysler 300

Reference: Case Number [REDACTED]

Confirming my discussions with Tomball Dodge (Anthony Ehlers) and Chrysler Customer Care (Shannon – Employee Number SR1255), earlier today, this letter is to notify you that I have a serious concern about the safety of my 2012 Chrysler.

I took my Chrysler to the dealership where I purchased it, with a concern about the gear shifter. It became stiff and was difficult to put it into gear. After several days, the dealership diagnosed the problem, I was informed by the Service Advisor, Mr. Anthony Ehlers, that the gear shifter would have to be replaced; however, unfortunately, it is on "Back-order".

He informed me that it was safe for me to drive the vehicle, until the part is received. I was out of the country for more than a week and when I returned home, I drove my car, for several days and noticed that it was very difficult for me to shift from Drive (D) to Park (P). It seemed to get stuck in Reverse (R). This is a serious safety issue and I am fearful that my vehicle may be subjected to an unfortunate crash, because of this faulty shifter.

The purpose for this letter is to place you on notice and inform you of this potentially dangerous situation. I suggest that Chrysler provide me with a replacement vehicle, without charge, until my current vehicle is repaired. I have been informed by Ms. Shannon, that the expected date of delivery for the part is April 4th, 2014. This is unacceptable, considering the potential danger that this shifter provides.

I want my concerns to be a matter of record, in the event that the defective shifter of my car is the cause of a crash due to this faulty gear shifter.

I will await your expeditious and favorable response to my concerns. Thank you, in advance, for your courtesies and consideration.

Sincerely,

[REDACTED]

Cc: Mr. Jason Douglas, GSM, Tomball Dodge
Mr. Anthony Ehlers, Service Advisor, Tomball Dodge



SPRING, TEXAS

FACSIMILE TRANSMITTAL SHEET

TO: Chrysler Customer Care FROM: [Redacted]

ORGANIZATION: Chrysler Corporation DATE: February 6, 2014

TOTAL NO. OF PAGES INCLUDING COVER: Three (3) Pages

RE: Case Number [Redacted]

URGENT FOR REVIEW PLEASE COMMENT PLEASE REPLY PLEASE RECYCLE

NOTES/COMMENTS:

Please refer to the following letter citing my concerns about the safety of my vehicle



CC: Mr. JASON DOUGLAS, GSM Tomball/Dodge
Mr. ANTHONY EHLERS, Service Consultant

I will await your expeditious and favorable response to my concerns. Thank you, in advance, for your courtesies and consideration.

Sincerely,

A solid black rectangular redaction box covering the signature area.

Cc: Mr. Jason Douglas, GSM, Tomball Dodge
Mr. Anthony Ehlers, Service Advisor, Tomball Dodge



SPRING, TEXAS

FACSIMILE TRANSMITTAL SHEET

TO: Chrysler Customer Care FROM: [Redacted]

ORGANIZATION: Chrysler Corporation DATE: February 6, 2014

TOTAL NO. OF PAGES INCLUDING COVER: Three (3) Pages



RE: Case Number [Redacted]

URGENT FOR REVIEW PLEASE COMMENT PLEASE REPLY PLEASE RECYCLE

NOTES/COMMENTS:

Please refer to the following letter citing my concerns about the safety of my vehicle.



CC: ✓ Mr. JASON DOUGLAS, GSM Tomball Dodge
✓ Mr. ANTHONY EHLERS, Service Consultant

[REDACTED]
Spring, TX [REDACTED]

February 6, 2014

Chrysler Customer Care
P.O. Box 21-8004
Auburn Hills, MI 48321-8004

Subject: Notification of Safety Concern – 2012 Chrysler 300

Reference: Case Number [REDACTED]

Confirming my discussions with Tomball Dodge (Anthony Ehlers) and Chrysler Customer Care (Shannon – Employee Number SR1255), earlier today, this letter is to notify you that I have a serious concern about the safety of my 2012 Chrysler.

I took my Chrysler to the dealership where I purchased it, with a concern about the gear shifter. It became stiff and was difficult to put it into gear. After several days, the dealership diagnosed the problem, I was informed by the Service Advisor, Mr. Anthony Ehlers, that the gear shifter would have to be replaced; however, unfortunately, it is on "Back-order".

He informed me that it was safe for me to drive the vehicle, until the part is received. I was out of the country for more than a week and when I returned home, I drove my car, for several days and noticed that it was very difficult for me to shift from Drive (D) to Park (P). It seemed to get stuck in Reverse (R). This is a serious safety issue and I am fearful that my vehicle may be subjected to an unfortunate crash, because of this faulty shifter.

The purpose for this letter is to place you on notice and inform you of this potentially dangerous situation. I suggest that Chrysler provide me with a replacement vehicle, without charge, until my current vehicle is repaired. I have been informed by Ms. Shannon, that the expected date of delivery for the part is April 4th, 2014. This is unacceptable, considering the potential danger that this shifter provides.

I want my concerns to be a matter of record, in the event that the defective shifter of my car is the cause of a crash due to this faulty gear shifter.

I will await your expeditious and favorable response to my concerns. Thank you, in advance, for your courtesies and consideration.

Sincerely,

[REDACTED]

Cc: Mr. Jason Douglas, GSM, Tomball Dodge
Mr. Anthony Ehlers, Service Advisor, Tomball Dodge

EA16-002

FLAT CHRYSLER

5-12-2016

ENCLOSURE 04

CAIR Backup

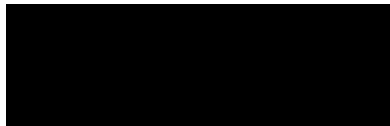



**OFFICE OF THE
ATTORNEY GENERAL**

**Request for Arbitration by the
Florida New Motor Vehicle
Arbitration Board**

FOR OFFICE USE ONLY

Indicate Date:

Filed	_____
Rejected	_____
Withdrawn	_____
Approved	_____
Case #	_____

I DO NOT WISH TO RECEIVE SOLICITATION MATERIALS FROM ATTORNEYS

4.24

RECEIVED

I. CONSUMER INFORMATION

MAY 01

SPECIAL INVESTIGATIONS

- Purchaser/Lessee Name(s): _____
- Street Address: _____
 City: North Miami State: FL Zip Code: _____
 Mailing Address (if different): _____
 City: _____ State: _____ Zip Code: _____
- Home Phone: _____ Best Time to Call: Evening
 Work Phone: () _____ For Whom? _____
 Cell Phone: () _____ For Whom? _____
 Fax: () _____ E-Mail: _____

Attorney Information (complete only if you are represented by an attorney):

Name: _____
 Mailing Address: _____
 City: _____ State: _____ Zip Code: _____
 Telephone: () _____ Fax: () _____ E-Mail: _____

II. SELLING DEALER, FINANCING, AND LEASING INFORMATION

- Dealer Name: Arrigo Dodge, Chrysler, Jeep Saugrass
 Address: 5901 Madison Ave
 City: Tamarac State: FL Zip Code: 33321

II. SELLING DEALER, FINANCING, AND LEASING INFORMATION (continued)

Lessor, bank, or lending institution to which loan or lease payments are made:

Name: _____

Address: _____

City: _____ State: _____ Zip Code: _____

III. RELIEF REQUESTED (Check one only)

5. If successful, I prefer to receive: A refund or
 A replacement vehicle

IV. VEHICLE INFORMATION

6. Vehicle Type: Car Truck _____ Van _____ Sport Utility _____ Low Speed Vehicle _____

7. If a truck, is the gross vehicle weight 10,000 pounds or less? Yes _____ No _____

8. Manufacturer: Chrysler
(GM, Ford, Chrysler, Toyota, etc.)

9. Make: Dodge Model: Charger Year: 2012
(Dodge, Mercury, etc.) (Mustang, Accord, etc.)

10. Vehicle Identification Number (VIN): 2C3CDXHG2CH XXXXXXXXXX
(This is a 17-character identifier usually consisting of letters and numerals that is listed on your vehicle registration.)

11. If a conversion vehicle, give the name of the company that performed the conversion, if known:

(Explorer Vans, Sherrod, etc. Attach a copy of the warranty.)

a. Was the conversion work performed prior to your purchase? Yes _____ No _____

b. If after your purchase, was the conversion work performed by or through the dealership as an option, referral or part of the sale? Yes _____ No _____

IV. VEHICLE INFORMATION (continued)

12. Date you took delivery of the vehicle? March 18, 2012

Mileage on the odometer on the date of delivery: 65

13. Was the vehicle (check one):
 Purchased Leased
 In Florida? Yes No
 As (check one): New Demonstrator Used

14. If leased, for a term of one year or more? Yes No

15. Do you still own or possess the vehicle? Yes No

16. If purchased used, was the vehicle transferred to you by the original owner within 24 months after the date of original delivery? Yes No

a. If yes, complete the following:

Original owner's name: _____

State where vehicle was originally purchased: _____

Actual date of delivery to original owner: _____

V. INFORMATION REGARDING PROBLEM(S) WITH VEHICLE

17. List each problem (other than routine maintenance and minor warranty repairs), that was first reported to the authorized service agent (dealer) within 24 months after the date of delivery, and that you claim **substantially impairs** the use, value or safety of the vehicle. Give the dates of at least three repair attempts that took place before the date written notification was sent to the manufacturer. If a substantial problem had less than three repairs before notification, list it and the repair date(s). Attach a separate sheet if necessary. Do not list the same problem more than once. **Please attach copies of repair orders for all repairs to the listed defects, even if there were more than three repairs.**

	Problem	Date 1	Date 2	Date 3
1.	<u>would not intake fuel</u>	<u>10-04-12</u>	<u>11-13-12</u>	
2.	<u>shifter would not get off park</u>	<u>10-09-12</u>	<u>11-05-12</u>	<u>08-13-15</u>
3.	<u>back up camera stopped working</u>	<u>12-28-13</u>		
4.	<u>trunk opens randomly</u>	<u>11-13-12</u>		
5.				
6.				

V. INFORMATION REGARDING PROBLEMS(S) WITH VEHICLE (continued)

18. Did you notify the manufacturer (not the dealer) identified in Question 8 in writing after three or more repair attempts for the problem(s)? Yes _____ No

If yes, date the manufacturer received notification: _____

a. (Answer only if applicable.) Did you notify the conversion company identified in Question 11 in writing after three or more repair attempts? Yes _____ No _____

If yes, date the conversion company received the notification: _____

(Attach a copy of the motor vehicle defect notification form or other written notification and postal receipt indicating when the manufacturer and/or conversion company received the notification.)

19. Following receipt of the notification, did the manufacturer and/or conversion company make a final attempt to correct the problem(s)? Yes _____ No _____

If yes, on what date(s)? _____

(Attach copies of all repair orders related to any final repair attempt).

If no, explain why there was no final repair attempt: _____

20. How many cumulative calendar days do you contend the vehicle was out of service for repair of one or more of the problems described in Question 17? _____

a. Did you notify the manufacturer (not the dealer) identified in Question 8 and, if applicable, the conversion company identified in Question 11 in writing after 15 or more days out of service? Yes _____ No _____

If yes, date(s) the manufacturer and/or conversion company received notification:

Manufacturer: _____ Conversion Company: _____

If no, explain why: _____

21. Following receipt of the notification, did the manufacturer, conversion company or authorized service agent (the dealer) have the opportunity to inspect or repair the vehicle? Yes _____ No _____

If no, explain why: _____

22. Is the problem(s) about which you are complaining the result of an accident, abuse, neglect, modification or alteration by someone other than the manufacturer, conversion company or an authorized service agent (the dealer)? Yes _____ No

VI. PARTICIPATION IN CERTIFIED MANUFACTURER PROCEDURE

23. Did you participate in a state-certified manufacturer's informal dispute settlement procedure?

Yes _____

No

If yes, what was the name of the procedure? _____

(BBB/AUTOLINE, NCDS, etc.)

Date the procedure received your claim: _____

Date of your hearing (if applicable): _____

Mileage: _____

Did that procedure render a decision?

Yes _____

No _____

If no, explain why: _____

If yes, were you satisfied with the decision of the procedure?

Yes _____

No _____

Date of final decision or action of the procedure? _____

You must attach copies of: your claim, postal receipt or letter from the program acknowledging receipt, and the decision of the program, if applicable.

VII. PREVIOUS ARBITRATION (by State Board Only)

24. Is this your first request for arbitration by the Florida New Motor Vehicle Arbitration Board for this vehicle?

Yes

No _____

If no, was previous application:

Withdrawn by you _____

Rejected by screening agency _____

If neither withdrawn nor rejected, what happened? _____

Did you have a hearing?

Yes _____

No _____

Case Number: _____

If you had a hearing and lost, explain how you believe your circumstances have significantly changed since your hearing to now qualify your vehicle for a refund or replacement (add a separate sheet of paper if necessary).

VIII. PRICE INFORMATION

IMPORTANT!!! Please attach a copy of your Vehicle Invoice, Bill of Sale, Finance or Retail Installment (loan) Agreement or Lease Agreement, along with copies of any invoices, canceled checks, etc. evidencing amounts paid by you in connection with your purchase or lease of the vehicle [including government fees and taxes (not financed), window tinting, extended service agreement, vehicle add-ons, etc.]. Include verification of periodic payments made.

Did you incur any reasonable expenses (e.g., towing, rental car, repair bills, postage, etc.) as a **direct** result of the defect(s) for which you were not reimbursed?

Yes _____

No

If yes, please attach copies of receipts, invoices, etc., to show how much you paid.

IX. VERIFICATION

False official statements: Whoever knowingly makes a false statement in writing with the intent to mislead a public servant in the performance of his official duty shall be guilty of a misdemeanor of the second degree, punishable as provided in ss. 775.082, 775.083, and 775.084, Florida Statutes.

I hereby request arbitration of my case by the Florida New Motor Vehicle Arbitration Board. I certify that all statements made in connection with this request for arbitration are true and correct to the best of my knowledge. I understand that this document and its attachments are public records. NOTE: This form must be signed by the Consumer(s).

Signature (First Consumer)

Signature (Second Consumer)

Date

Mileage

VIP Summary Report

Dealer: 60539 - AVENTURA CHRYSLER JEEP DODGE RAM

Date: December 28, 2013 Time: 12:01:49

VIN: 2C3CDXHG2CH [REDACTED]

Dealer Entered Name: CHAR

Dealer Entered Odometer: 27,348 miles

STRICTLY CONFIDENTIAL: This information is provided to DEALER, in accordance with Section 4 of DEALER's Software License, Data Exchange and Electronic Commerce Agreement with Chrysler Group LLC. All information provided is based on entries provided by DEALER.

EMISSIONS	36 Months or 36,000 miles	0	March 18, 2015	15 Months or 8,652 miles
ADJUSTMENT	36 Months or 36,000 miles	0	March 18, 2015	15 Months or 8,652 miles
AIR CONDITIONING	36 Months or 36,000 miles	0	March 18, 2015	15 Months or 8,652 miles
EXTENDED FEDERAL EMISSIONS	96 Months or 80,000 miles	0	March 18, 2020	74 Months or 52,652 miles
WCC	Roadside Assistance	Towing Assistance	Master Shield	Transferable-Powertrain Warranty
536	See Contract	Yes	N/A	Yes

Service Contract Information

Service Contract(1 of 1)

THIS OPTION COVERS OIL AND FILTER CHANGES ONLY, ADDITIONAL MAINTENANCE SERVICES ARE NOT COVERED

TOWING AND ALLOWANCE COVERED BY CROSS COUNTRY MOTOR CLUB. PRIOR AUTHORIZATION REQUIRED. 800-521-2779

THIS SERVICE CONTRACT OPTION IS NOT TRANSFERABLE.

Contract Number:	36499028	Name:	ANNE R CHARPENTIER
		Secondary Name:	
Option Code:	OCS24N	Description:	OWNER CARE - 2 YEARS / 4 OIL CHANGES
Effective Date/Odometer:	March 18, 2012 @ 0 miles	Option Sale Date:	March 18, 2012
Expiration Date/Odometer:	March 18, 2014 @ 999,999 miles	Option Sale State:	MI
Contract Selling Dealer:	S0104 - SEBC LOF OWNER LOYALTY		
Maximum Rental Amount per Day:	0.00	First Day Rental:	No
Maximum Rental Allowance per Visit:	0.00	Deductible:	0.00
Maximum Oil Change Allowance:	30.00	Towing Allowance:	100.00
Remaining Oil Changes:	0	Roadside Assistance:	Yes
		Road Hazard:	No
		Trip Interruption:	No
Reduce Warranty Deductible:	No		
Transfer Fee:	0.00	Cancellation Fee:	0.00
Transferred:	No	Status:	01 ACTIVE

Service History (24 Month)

Repair Date	Dealer/Payee	Claim Number	Repair Odometer	List Date	Transaction Type
October 22, 2013	60539 - AVENTURA CHRYSLER JEEP DODGE R 26860303 - Oil and Filter Change - All in	[REDACTED]	25,316 Miles	2013105	SERVICE CONTRACT
August 31, 2013	45426 - ARRIGO DODGE CHRYSLER JEEP RAM	[REDACTED]	23,826 Miles	2013091	WARRANTY

CUSTOMER # [REDACTED]

INVOICE



5901 Madison Ave., Tamarac, FL 33321
(954) 861-6200 - Fax: (954) 861-6233
Arrigosawgrass.com
Registration No. MV - 70113

PAGE 1

NORTH MIAMI FL [REDACTED]

HOME: [REDACTED]

BUS: CELL: SERVICE ADVISOR: 12194 GEORGE DAVID RIKER

COLOR	YEAR	MAKE/MODEL	VIN	LICENSE	MILEAGE IN / OUT	TAG
PW7 Bright	12	DODGE CHARGER	2C3CDXHG2CH [REDACTED]	[REDACTED]	22767/22772	T2179
DEL. DATE	PROD. DATE	WARR. EXP.	PROMISED	PO NO.	RATE	PAYMENT
18MAR12 IS			17:00 13AUG13			CASH
18MAR12 DD						13AUG13
R.O. OPENED	READY	OPTIONS:	SOLD-STK:	DLR:43864		
17:54 12AUG13	16:40 13AUG13	TRN:DFG 8-Spd Auto 8HP45	Eng:ERB 3.6L V6 24v vvt Engine	Trans (Buy)		

LINE OPCODE TECH TYPE HOURS LIST NET TOTAL

A CUSTOMER STATES CHECK ABS LIGHT ON
 10DOZ MAINTENANCE SERVICE
 12200 PARISH,VINCENT LIC#: 12200
 WARR (N/C)
 PARTS: 0.00 LABOR: 0.00 OTHER: 0.00 TOTAL LINE A: 0.00
 RELATED TO LINE B

B CUSTOMER STATES CHECK SHIFTER COULDN'T GET GET OUT OF PARK SHIFTER
 WOULD MOVER BUT DIDN'T COME OUT OF PARK
 CAUSE: CODE FOR SHIFTER P1C86-14/TCMP1DC9-00
 10DOZ MAINTENANCE SERVICE
 12200 PARISH,VINCENT LIC#: 12200
 WARR (N/C)
 1 68140727AD SHIFTER-TRANSMISSION (N/C)
 PARTS: 0.00 LABOR: 0.00 OTHER: 0.00 TOTAL LINE B: 0.00
 R/R CENTER ESM MODULE/CLEAR CODES/NOTE ADVISE CUSTOMER OF EXCESSIVE
 AMOUNT OFWIDE OPEN TROTTLE DRIVING/AND EXCESSIVE AMOUNT PADDLE SHIFT
 USAGE IN LOW GEAR/WILL CAUSE ENG LIGHT TO TURN ON/NOTE SOP SHIFT PADDLE

C PROVIDE RENTAL VEHICLE FOR CLIENT
 RENTAL PROVIDE RENTAL VEHICLE FOR CLIENT
 12200 PARISH,VINCENT LIC#: 12200
 CWFID 0.00 0.00
 PARTS: 0.00 LABOR: 0.00 OTHER: 0.00 TOTAL LINE C: 0.00
 DONE

NOW ARRIGO DODGE CHRYSLER JEEP SAWGRASS IS
 OPEN MONDAY THRU FRIDAY 7:30AM TO 6:00PM
 SATURDAY 8:00AM TO 5:00PM
 BOOK YOUR NEXT SERVICE APPOINTMENT ONLINE
 AT WWW.ARRIGOSAWGRASS.COM
 THANK YOU AND COME AGAIN!

CASH []	CHECK []	MC/VS []	AMEX []	DESCRIPTION	TOTALS
DISC []	POL []	FIDEL []	CHARGE []	LABOR AMOUNT	0.00
CHRYSL []	OTH []			PARTS AMOUNT	0.00
				GAS, OIL, LUBE	0.00
				SUBLET AMOUNT	0.00
				MISC. CHARGES	0.00
				TOTAL CHARGES	0.00
				LESS INSURANCE	0.00
				SALES TAX	0.00
				PLEASE PAY THIS AMOUNT	0.00



CHRYSLER-DODGE-JEEP
 14375 South Tamiami Trail
 FT. MYERS, FLORIDA 33912
 Phone: 239-481-2600



Jeep

MOTOR VEHICLE REPAIR SHOP
 REGISTRATION # MV-01645
 ALL PARTS ARE NEW UNLESS OTHERWISE INDICATED

CELL: [REDACTED]

CUSTOMER NO	[REDACTED]	ADVISOR	VICKI DILLIPLANE	7037	TAG NO.	3601	INVOICE DATE	11/13/12	INVOICE NO	[REDACTED]
[REDACTED]	[REDACTED]	LABOR RATE	109.00	LICENSE NO		MILEAGE	13,328	COLOR	WHITE/	[REDACTED]
[REDACTED]	[REDACTED]	YEAR / MAKE / MODEL	12/CHRYSLER/CHARGER/4DR SDN SXT			DELIVERY DATE		DELIVERY MILES		
N MIAMI, FL	[REDACTED]	VEHICLE I.D. NO.	2 C 3 C D X H G 2 C H			SELLING DEALER NO.		PRODUCTION DATE		
NONE		F.T.E. NO.		P.O. NO.		H.O. DATE	11/13/12			
RESIDENCE PHONE	BUSINESS PHONE	COMMENTS								

MO: 13331

JOB# 1 CHARGES-----

LABOR-----
 J# 1 14CHZ FUEL TECH(S) 7032 WARRANTY
 SOP FUEL TUBE INSTALL
 EVAP LEAK
 TEST AND REPLACED FUEL FILLER NECK
 YOUR VEHICLE HAS BEEN QUALITY CONTROL AND PASSED INSPECTION

PARTS-----QTY---FP-NUMBER-----DESCRIPTION-----UNIT PRICE-----WARRANTY
 1 4584555-AH TUBE FUEL 14086002
 TOTAL - PARTS 0.00

JOB# 1 TOTALS-----

JOB# 2 CHARGES----- JOB# 1 JOURNAL PREFIX CHCS JOB# 1 TOTAL 0.00

LABOR-----
 J# 2 23CHZ BODY MECH /INT TECH(S) 7032 WARRANTY
 CUSTOMER STATES THE TRUNK RANDOMLY COMES AJAR
 TEST AND INSPECT, COULD NOT DUPLICATE CUSTOMERS CONCERN AT
 THIS TIME

JOB# 2 TOTALS-----

JOB# 2 JOURNAL PREFIX CHCS JOB# 2 TOTAL 0.00

COMMENTS-----
 WAITING

TECHNICIAN CERTIFICATION-----
 7032 MATTHEW 7454

© 2009 The Reynolds and Reynolds Company. All rights reserved. E-MANTRA® (2007) 0010



CHRYSLER-DODGE-JEEP
 14375 South Tamiami Trail
 FT. MYERS, FLORIDA 33912
 Phone: 239-481-2600



MOTOR VEHICLE REPAIR SHOP
 REGISTRATION # MV-01645

ALL PARTS ARE NEW UNLESS OTHERWISE INDICATED

CUSTOMER NO	ADVISOR	TAG NO.	INVOICE DATE	CELL
	WILLIAM	7059 3604	10/04/12	
	LABOR RATE	LICENSE NO.	MILEAGE	COLOR
	109.00		11,449	WHITE/
	YEAR / MAKE / MODEL		DELIVERY DATE	STOCK NO.
	12/CHRYSLER/CHARGER/4DR SDN SXT			
	VEHICLE I.O. NO.		SELLING DEALER NO.	PRODUCTION DATE
	2 C 3 C D X H G 2 C H			
	F.T.E. NO.	P.O. NO.	R.O. DATE	
			10/04/12	
RESIDENCE PHONE	BUSINESS PHONE	COMMENTS		
				MO: 11450

JOB# 1 CHARGES

LABOR
 JOB# 1 CHZ FUEL TESTS/WARRANTY

CUST STATES THAT FUEL FILL NOZZLE NOT OPENING /PLEASE CHECK AND REPORT TEST AND INSPECT,OPPERATING AS DESIGNED YOUR VEHICLE HAS BEEN QUALITY CONTROL AND PASSED INSPECTION

JOB# 1 TOTALS

JOB# 1 JOURNAL PREFIX CHCS JOB# 1 TOTAL 0.00

COMMENTS
 WAITING

TECHNICIAN CERTIFICATION
 144 ALEX TUCHBAUM 4447

TOTALS

*****	TOTAL LABOR....	0.00
* [] CASH [] CHECK CK NO. [] *	TOTAL PARTS....	0.00
* [] VI/MC [] DISCOVER [] AMEX *	TOTAL SUBLET...	0.00
* [] CHARGE *	TOTAL G.O.G....	0.00
*****	TOTAL MISC CHG.	0.00
	TOTAL MISC DISC	0.00
	TOTAL TAX.....	0.00

TOTAL INVOICE \$ 0.00

DEAR VALUED CUSTOMER:
 YOU WILL BE RECEIVING A SATISFACTION INQUIRY FROM CHRYSLER REGARDING THE SERVICE WE PROVIDED TO YOU TODAY. THIS SURVEY IS "VERY IMPORTANT" TO US. PLEASE TAKE A MOMENT TO FILL IT OUT AND MAIL IT IN. IF YOU CAN NOT ANSWER THE INQUIRY 100% SATISFIED, PLEASE CALL GEORGE ANGELOFF @ EXT. 1084 HELP US, HELP YOU.

CUSTOMER SIGNATURE

© 2008 The Borsari and Reynolds Company. All rights reserved. PRINTED ON RECYCLED PAPER.

CUSTOMER #:

INVOICE



5901 Madison Ave., Tamarac, FL 33321
(954) 861-6200 - Fax: (954) 861-6233
Arrigosawgrass.com
Registration No. MV - 70113

NORTH MIAMI, FL 3

PAGE 1

HOMI
BUS: CELL: SERVICE ADVISOR: 12410 STEVEN RUTH

Table with columns: COLOR, YEAR, MAKE/MODEL, VIN, LICENSE, MILEAGE IN / OUT, TAG. Row 1: PW7 Bright, 12, DODGE CHARGER, 2C3CDXHG2C, 11761/11763, T1650. Row 2: DEL. DATE, PROD. DATE, WARR. EXP., PROMISED, PO NO., RATE, PAYMENT, INV. DATE. Row 3: 18MAR12 IS, 18MAR12 DD, WAIT 09OCT12, 0.00, CASH, 09OCT12.

R.O. OPENED READY OPTIONS: STK DLR:43864
ENG:ERB 3.6L V6 24V VVT Engine
TRN:DFG 8-Spd Auto 8HP45 Trans (Buy)

Table with columns: LINE, OPCODE, TECH, TYPE, HOURS, LIST, NET, TOTAL

A PERFORM COMPLIMENTARY WORLD CLASS INSPECTION
10DOZ-16PT PERFORM COMPLIMENTARY WORLD CLASS INSPECTION
12157 CPS 0.00 0.00 0.00 0.00 TOTAL LINE A: 0.00

B CHRYSLER SERVICE CONTRACT: OIL AND FILTER CHANGE REDEMPTION
CAUSE:
26860303 CHRYSLER SERVICE CONTRACT: OIL AND FILTER CHANGE REDEMPTION
12157 WCEX (N/C)
1 68079744AB FILTER-ENGINE OIL (N/C)
6 68055891AA *OIL-5W30 (N/C)
PARTS: 0.00 LABOR: 0.00 OTHER: 0.00 TOTAL LINE B: 0.00

C OWNER STATES THE GEAR SHIFTER WARNING LIGHT IS ON.
CAUSE:
18190602 Module, Powertrain Control (PCM) - Reprogram Gasoline engines only (C) 9697 WARR (N/C)
4 4275086AD LABEL-GENERAL INFORMATION FC: FM (N/C)
PART#: 4275086AD
COUNT: 4
CLAIM TYPE: W
AUTH CODE:

PARTS: 0.00 LABOR: 0.00 OTHER: 0.00 TOTAL LINE C: 0.00
COMPLETED TECH FOUND NO CODES IN THE SYSTEM NOW. ALL SYSTEMS ARE WORKING AS DESIRED. TECH FOUND AVILABLE PCM UPDATE AND PERFORMED AS A PRECAUTIONARY MEASURE.

Table with columns: CASH, CHECK, MC/VS, AMEX, DISC, POL, FIDEL, CHARGE, CHRYSL, OTH, DESCRIPTION, TOTALS. Includes rows for LABOR AMOUNT, PARTS AMOUNT, GAS, OIL, LUBE, SUBLET AMOUNT, MISC. CHARGES, TOTAL CHARGES, LESS INSURANCE, SALES TAX, PLEASE PAY THIS AMOUNT.

CUSTOMER #:



INVOICE

the Aventura
AUTO GALLERY
CHRYSLER JEEP DODGE RAM SRT

16050 W. Dixie Hwy
North Miami Beach, FL 33160
Phone: (305) 493-5000

NORTH MIAMI, FL

PAGE 1

Miami-Dade Vehicle License # 61670.MVR
State MVR # 87143

HOME:
BUS:

CELL:

SERVICE ADVISOR: 107 ARIEL MOLINA

COLOR	YEAR	MAKE/MODEL	VIN	LICENSE	MILEAGE IN / OUT	TAG
	12	DODGE CHARGER	2C3CDXHG2CH		27348/27348	T068

DEL. DATE	PROD. DATE	WARR. EXP.	PROMISED	PO. NO.	RATE	PAYMENT	INV. DATE
18MAR12 DE			17:00 26DEC13		110.00	CASH	28DEC13

R.O. OPENED	READY	OPTIONS:	DLR: MV-05846 ENG: 3.6 Liter				
12:04 28DEC13	13:12 28DEC13						

LINE	OPCODE	TECH	TYPE	HOURS	LIST	NET	TOTAL
------	--------	------	------	-------	------	-----	-------

A BACK UP CAMERA INOP. WAS TOLD TO BRING CAR TO REPROGRAM SYSTEM

SOP THE PARTS REQUIRED TO REPAIR YOUR VEHICLE HAD TO BE SPECIAL ORDERED. THEY USUALLY ARE READY WITHIN 5 DAYS, PLEASE CONSULT WITH YOUR SERVICE ADVISOR ON ARRIVAL DATE.

66 MEDEROS, FERNANDO LIC#: ,
ISP

(N/C)

27348 SOP PART BACK UP CAMERA

B PERFORM COURTESY VEHICLE INSPECTION
CAUSE: INSPECTION

CVI PERFORM COURTESY VEHICLE INSPECTION
66 MEDEROS, FERNANDO LIC#: ,
ISP

(N/C)

27348 COMPLETE

THANK YOU FOR SERVICING YOUR VEHICLE WITH US
...WE HOPE TO SEE YOU SOON AGAIN...

Service Limited Warranty: The only warranties applying to the part(s) installed in accordance with this estimate are those that may be offered by the manufacturer. The seller hereby expressly disclaims all warranties either expressed or implied, including any implied warranty of merchantability or fitness for a particular purpose and neither assumes for it any liability in connection with the sale of products or services sold under the terms of this estimate. Parts and labor are guaranteed for 12 months or 12000 miles whichever comes first. Seller does not guarantee that the work performed in accordance with this estimate will correct any problems specified on the description of the complaint. All labor charges are based on published Standard Times to perform repairs, but may be more or less than those Standard Times dependent on variances on a standard repair or service.

***Shop Supply Cost:** We have added a charge equal to \$3.00 or 10% of the total cost of labor and parts, whichever is greater, to the repair order. This charge will not exceed \$59.95. This charge represents cost and profits to the motor vehicle repair facility for miscellaneous shop supplies and environmental waste disposal. The State of Florida requires a fee of \$1.00 to be collected for each new tire sold in the state (F.S.403.7181), and a \$1.50 fee to be collected for each new or remanufactured lead-acid battery sold in the state (F.S.403.71851). *Any replacement parts installed which are used, rebuilt or reconditioned will be indicated using NPN or obtain a description as such*

DESCRIPTION	TOTALS
LABOR AMOUNT	0.00
PARTS AMOUNT	0.00
GAS, OIL, LUBE	0.00
SUBLET AMOUNT	0.00
MISC. CHARGES	0.00
TOTAL CHARGES	0.00
	0.00
SALES TAX	0.00
PLEASE PAY THIS AMOUNT	0.00

By signing below, you acknowledge that you were notified of and authorized Dealership to perform the services/repairs itemized in this invoice and that you received for had the opportunity to inspect any replaced parts as requested by you. The vehicle is being returned to you in exchange for your payment of the Amount Due. Customer hereby acknowledges receipt of the above mentioned vehicle, and receipt of invoice copy hereof.

Motor Vehicle Defect Notification

(Please print clearly in ink. If you do not wish to receive letters or other written solicitations from private attorneys, check below)

I DO NOT WISH TO RECEIVE WRITTEN SOLICITATION MATERIALS FROM AN ATTORNEY

Pursuant to the Florida Lemon Law, notice is given to the manufacturer as follows:

The vehicle has been out of service at least 15 days to repair one or more substantial defects.

3 or more repair attempts have been made to repair the same substantial defect or condition.

Description of continuing defect(s) or condition(s) _____

(NOTE: this is not a complete list; the manufacturer should ascertain all repair information.)

I am requesting that you make a final attempt to correct the continuing substantial defect(s) or condition(s).

Vehicle Make Dodge Model Charger Year 2012

VIN 21P15181D1X1H1G1Z1C1H12 [redacted] Date of Delivery March 18, 2012

Name and City/State of selling dealer or leasing company (if applicable) Arrigo Dodge Chrysler Jeep
Sawgrass 5901 Madison Ave, Tamarac, FL 33321

Name and City/State of authorized service agent(s) attempting previous repairs: Arrigo Dodge Chrysler Jeep
Sawgrass Tamarac, FL Galeana Chrysler Dodge Jeep Fort Myers, FL
Aventura Auto Gallery Chrysler Jeep Dodge Ram North Miami Beach, FL

Consumer [redacted]
Address [redacted]
North Miami, FL [redacted]

Home phone (239) [redacted]
Work phone [redacted]
Signature [redacted]
Date Mailed 2/13/2014 ()

X. DOCUMENTS

Your application may be considered incomplete and processing will be delayed if you did not include the following applicable documents (please check documents submitted):

A copy of any warranty given by the conversion company identified in Question 11, if applicable

Copies of relevant repair orders in your possession (Questions 17, 19 and 20)

A copy of the defect notification form or other written notification you sent to each manufacturer or conversion company (Questions 18 and 20)

A copy of the postal receipt or other document indicating when the manufacturer and/or conversion company received your written notification (Questions 18 and 20)

A copy of the claim filed with a manufacturer's state-certified procedure (if applicable) (Question 23)

A copy of the decision of a manufacturer's state-certified procedure, if any (if applicable) (Question 23)

A copy of the vehicle purchase invoice, bill of sale, and the retail installment contract (loan agreement) or lease agreement (all that are applicable to your vehicle acquisition)

Copies of all receipts or invoices for items purchased in connection with your acquisition of the vehicle

Copies of all receipts or invoices for expenses directly caused by the defect(s)

Be sure to make and keep a copy of this form and all attachments for your own records.

Return completed original form with copies of all applicable documents attached to:

**Office of the Attorney General
Lemon Law Arbitration
PL-01, The Capitol
Tallahassee, Florida 32399-1050
850-414-3500**

DLA/LL-005(2-1-2006)

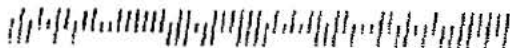

7012 0470 0001 7657 1884

PLACE STICKER AT TOP OF ENVELOPE TO THE RIGHT OF THE RETURN ADDRESS, FOLD AT DOTTED LINE

CERTIFIED MAIL™



1000

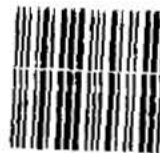

48321

U.S. POSTAGE
PAID
MIAMI, FL
33181
APR 24, 14
HMUN1

\$6.05

00043361-23

th Miami, Fl

Chrysler Group LLC
Customer Center
Chrysler Group LLC
P.O. Box 21-8004
Auburn Hills, MI 48321-8004

EA16-002

FLAT CHRYSLER

5-12-2016

ENCLOSURE 04

CAIR Backup

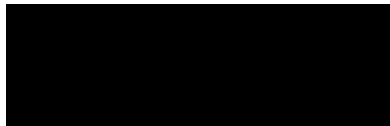



July 23, 2014

[REDACTED]
New Lenox, IL [REDACTED]

Re: [REDACTED]

VIN: 2C3CCAAG9D [REDACTED]

Dear Mr. [REDACTED]

This will further acknowledge contact to Chrysler Group LLC, regarding your 2013 Chrysler 300.

Naturally, we were sorry to learn of the incident described to us during the initial contact. However, we have had the opportunity to review the inspection report and must inform you that we are not led to believe that the incident was due to a manufacturing responsibility. Therefore, we must respectfully decline any assistance associated with this incident.

Based on this information, we can only suggest that you refer this matter to your insurance carrier. Should they feel a manufacturing responsibility exists, they have full subrogation rights under the terms of your policy.

Thank you for allowing us the opportunity in reviewing this matter with you.

Sincerely,

J. S. Susalla
Special Investigations
586-274-8171

JSS/ss



07/18/2014 10:59

3 LX 3.6L
 ID: 2C3CCAAG9DH [REDACTED]
 Battery: 12.28 volts

- Legend
- Active ECU
 - Non-responsive ECU
 - DTCs Present

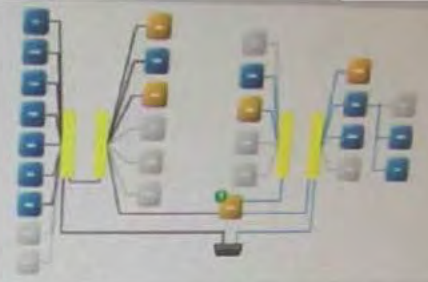

All DTCs Diagnostic Procedures Customer Preferences Vehicle Preparations

Double-click row selection to view environmental data. Click on column heading to sort table.

All Active Stored Pending

ECU	Code	Status	Description
BCM	B16C3-15	Stored	Front Right Sidemarker Lamp Control-Circuit Short to Battery or Open
BCM	B162E-15	Stored	Right Low Beam Control-Circuit Short to Battery or Open
BCM	B162A-15	Stored	Left Low Beam Control-Circuit Short to Battery or Open
BCM	B16BF-15	Stored	Front Left Sidemarker Lamp Control-Circuit Short to Battery or Open
BCM	B16D3-15	Stored	Right DRL Lamp Control-Circuit Short to Battery or Open
BCM	B16CF-15	Stored	Left DRL Lamp Control-Circuit Short to Battery or Open
BCM	U1175-00	Stored	Lost Ignition Status Message-
ESM	B25AA-00	Stored	Front Passenger Door Handle Sense-General Electrical Failure
RFH	B25AA-01	Stored	Front Driver Door Handle Sense-General Electrical Failure
RFH	B25A9-01	Stored	

Knowledge Base Articles Online 14.03.20



07/18/2014 11:02

AutoMate
 800.571.2676

ive ECU
on-responsive ECU
TCs Present



Diagnostic Procedures Customer Preferences Vehicle Preparations

Click row selection to view environmental data. Click on column heading to sort table.

Active | Stored | Pending

ECU	Code	Status	Description
BCM	B16C3-15	Stored	Front Right Sidemarkers Lamp Control-Circuit Short to Battery
BCM	B162E-15	Stored	Right Low Beam Control-Circuit Short to Battery
BCM	B162A-15	Stored	Left Low Beam Control-Circuit Short to Battery
BCM	B168F-15	Stored	Front Left Sidemarkers Lamp Control-Circuit Short to Battery
BCM	B16D3-15	Stored	Right DRL Lamp Control-Circuit Short to Battery
BCM	B16CF-15	Stored	Left DRL Lamp Control-Circuit Short to Battery
ESM	U1175-00	Stored	Lost Ignition Status Message
RFH	B25AA-00	Stored	Front Passenger Door Handle Sense
RFH	B25AA-01	Stored	Front Passenger Door Handle Sense-General Electrical
RFH	B25A9-01	Stored	Front Driver Door Handle Sense-General Electrical

Windows taskbar showing: Knowledge Base Articles, Online, start, EPAccess - R7DD16, 14.03.20

DELL

07/18/2014 11:02

Workshop area with papers, a green folder, and a Dell logo on the desk.

Auto/Moto

TCM View

Click on tabs to access various ECU operations and information for the selected ECU.

Search Service information

- Flash
- Data
- DTCs**
- Actuators
- System Tests
- Misc Functions
- ECU Details

Double-click row selection to view environmental data. Click on column heading to sort table.

All Active Stored Pending

ECU	Code	Status	Description
-----	------	--------	-------------

There are no DTCs present

Control Module
Number:
Version:
Version:
#, #1: 12.26.00
Number:
File:
Number:
File:
Number:
File:
VIN
CSDH

07/18/2014 11:03

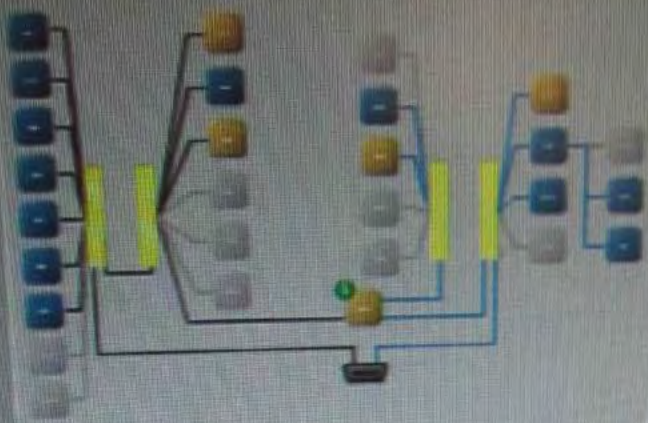

Flash

Double-

All | A

Overview

Name: Transmission Control Module
Flash Part Number: 68046526AL
Bus Type: CAN C
Hardware Version: 0A.03.1F
Software Version: #0: 12.26.00, #1: 12.26.00
Spare Part Number: Not Available
ISO Code:
Software Number: Not Available
Hardware Number: Not Available
Original VIN 2C3CCAAG9DH [REDACTED]

Knowledge Base Article

07/18/2014 11:04



PCM View

Click on tabs to access various ECU operations and information for the selected ECU.



- Flash
- Data
- DTCs**
- Actuators
- System Tests
- Misc Functions
- ECU Details

Double-click row selection to view environmental data. Click on column heading to sort table.

All Active Stored Pending

ECU	Code	Status	Description
There are no DTCs present			

Overview

Name: Powertrain Control Module
 Flash Part Number: 68171301AC
 Bus Type: CAN C
 Hardware Version: 12.47
 Software Version: 11.02.00
 Spare Part Number: Not Available
 ISO Code:
 Software Number: Not Available
 Hardware Number: Not Available
 Original VIN: 2C3CCAAAG1DH [REDACTED]

07/18/2014 11:04



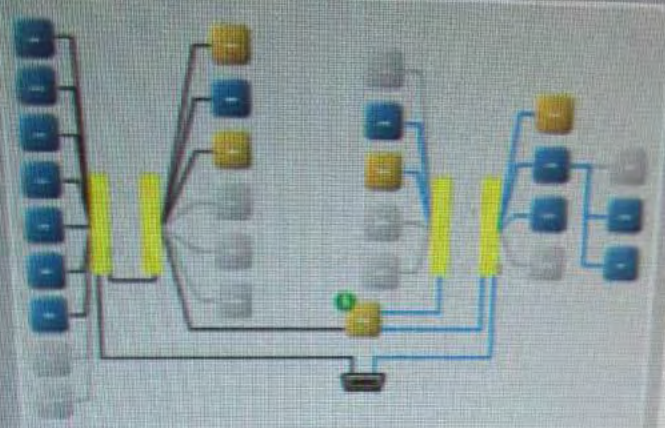

Overview

Name:
Powertrain Control Module

Flash Part Number:
68171301AC

Bus Type:
CAN C

Hardware Version:
12.47

Software Version:
11.02.00

Spare Part Number:
Not Available

ISO Code:

Software Number:
Not Available

Hardware Number:
Not Available

Original VIN
2C1CCAAG9DH1 [REDACTED]

Flash

Data

Double-click r

All Active

		ECL
--	--	-----

07/18/2014 11:04

Page 7 of 8

Page 8 of 8

Page 9 of 8



S 21326mi 58°
Press Brake and
Push Button to
Shift into Gear



P
R
N
D
L

The central display shows a graphic of a shift knob with a red and blue button. To its right is a vertical gear indicator with 'P', 'R', 'N', 'D', and 'L' labels.



07/18/2014 11:30

P

R

N

D/A

07/18/2014 11:30



SE 21327mi 58°
Vehicle Speed
0 mph
change to km/h
P
R
N
D
L



07/18/2014 11:30

P
R
N
D/L

07/18/2014 11:31



SE 21327mi 58°
Press Brake and
Push Button to
Shift into Gear



P
R
N
D
L



07/18/2014 11:31



07/18/2014 11:31



SE 21327mi 58°
Vehicle Speed
0 mph
↪ change to km/h
P R N D L



07/18/2014 11:31



07/18/2014 11:31



07/18/2014 11:33



E 21327mi 58°
Vehicle Speed
2 mph
▶ change to km/h
P
R
N
D
L



07/18/2014 11:33



07/18/2014 11:59



07/18/2014 11:59



07/18/2014 11:59



07/18/2014 12:00



07/18/2014 12:00



07/18/2014 10:14

DATE OF MFR(BUILT): OCT 12

GAWR: 01275 KG

REAR: 02810 LB

RAL MOTOR VEHICLE SAFETY,
EFFECT ON



VIN: 2C3CCAAG9DH [REDACTED]

MDH: 100909 065AA

VEHICLE MADE IN CANADA

PRINT: PAU

TYPE: PASSENGER CAR

TRIM: TLX9

4658843

07/18/2014 10:50



07/18/2014 10:50



07/18/2014 10:55



07/18/2014 10:56



USE ONLY Castrol motor oil.
For service intervals, please refer to the owner's manual.
Only check oil level when the engine is cold and the oil level is stable.
Do not overfill. If the oil level is low, add oil.
Do not open the oil filler cap when the engine is hot.
The oil level will rise and may cause an oil leak.
The oil level will also rise if the engine is running.
The oil level will also rise if the engine is running.
The oil level will also rise if the engine is running.

請使用嘉實多機油。
關於保養週期，請參閱車主手冊。
僅在引擎冷卻且油位穩定時檢查油位。
切勿加滿。若油位偏低，請添加機油。
切勿在引擎熱時開啟機油蓋。
引擎熱時，油位會上升，可能導致漏油。
引擎運行時，油位也會上升。
引擎運行時，油位也會上升。
引擎運行時，油位也會上升。

07/18/2014 10:56



07/18/2014 10:57



07/18/2014 10:58



07/18/2014 10:58



07/18/2014 10:58