

PE15-030

FLAT CHRYSLER

11-24-2015

ENCLOSURE 4

CAIR Backup





GRAND CHEROKEE





Jeep

4x4
AUTOLAND







TC098



















SALES
RENTAL
FINANCING
LEASING
SERVICES
SALES
RENTAL
FINANCING
LEASING
SERVICES

ANY NEW
ANY USED

\$59
OR
LESS

Vehicle View

Search Service Information

2014 WK 3.6L
 VIN: 1CARUJFCG3E [REDACTED]
 Battery: 13.386 volts

- Legend**
- Active ECU
 - Non-responsive ECU
 - DTCs Present
 - ECU Not Built
 - Scanning ECU
 - New Flash Available
 - CAN-C
 - CAN-IHS

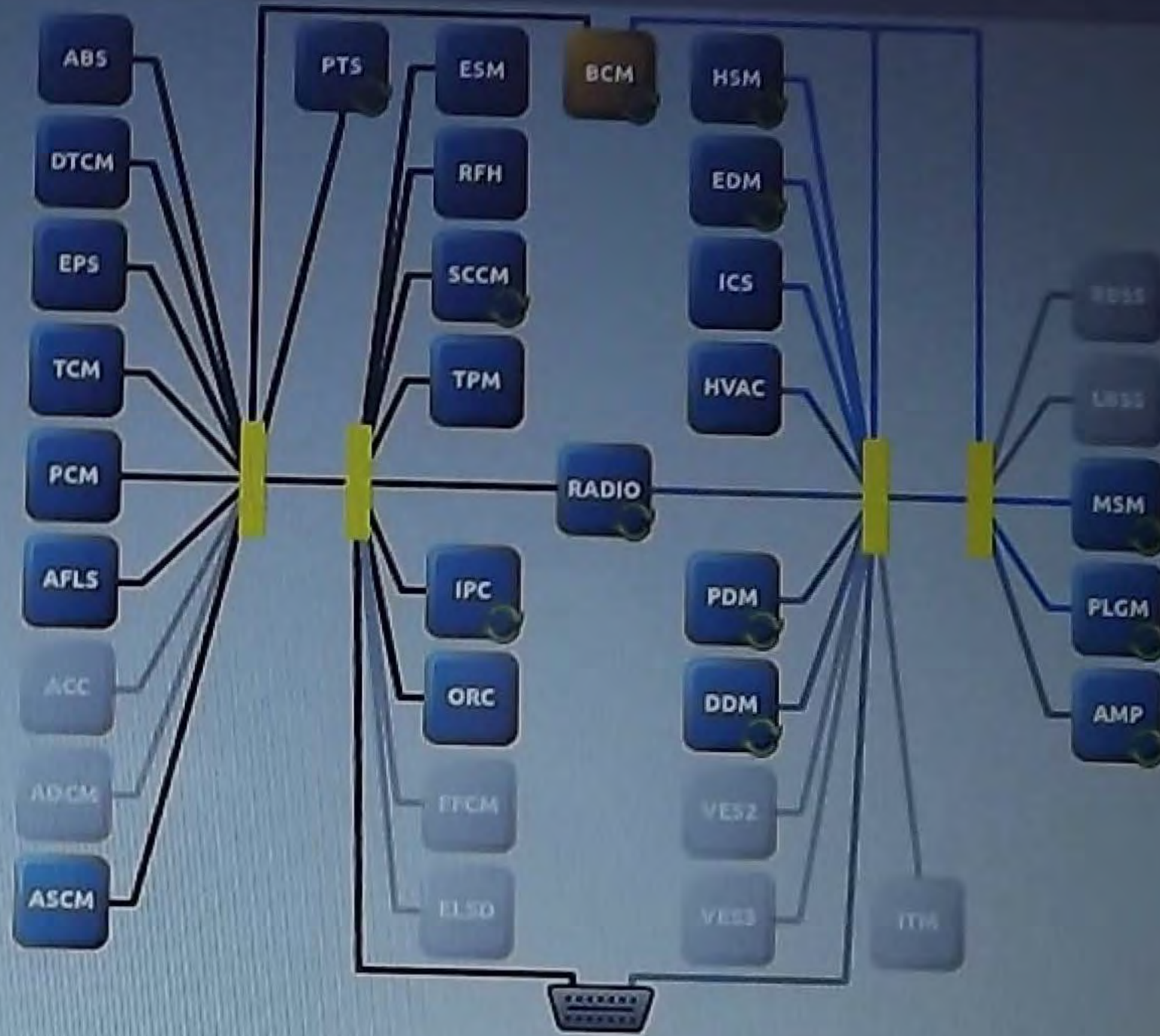

All DTCs **Diagnostic Procedures** Customer Preferences Vehicle Preparations

Double-click row selection to view environmental data. Click on column heading to sort table.

all Active Stored Pending

ECU	Code	Status	Description
BCM	B16DF-15	stored	Right Taillamp 1 Control-Circuit Short to Battery or Open

View Freeze Frame View Event Data Clear Stored DTC

Login Off-line

Disconnect Warn High











2014 WK 3.6L

VIN: 1C4RJFCG5EC [REDACTED]

Battery:  13.386 volts

Legend

-  Active ECU
-  Non-responsive ECU
-  DTCs Present
-  ECU Not Built
-  Scanning ECU
-  New Flash Available
-  CAN-C
-  CAN-IHS

All DTCs

Diagnostic Procedures

Customer Preferences

Vehicle Preparations

Double-click row select

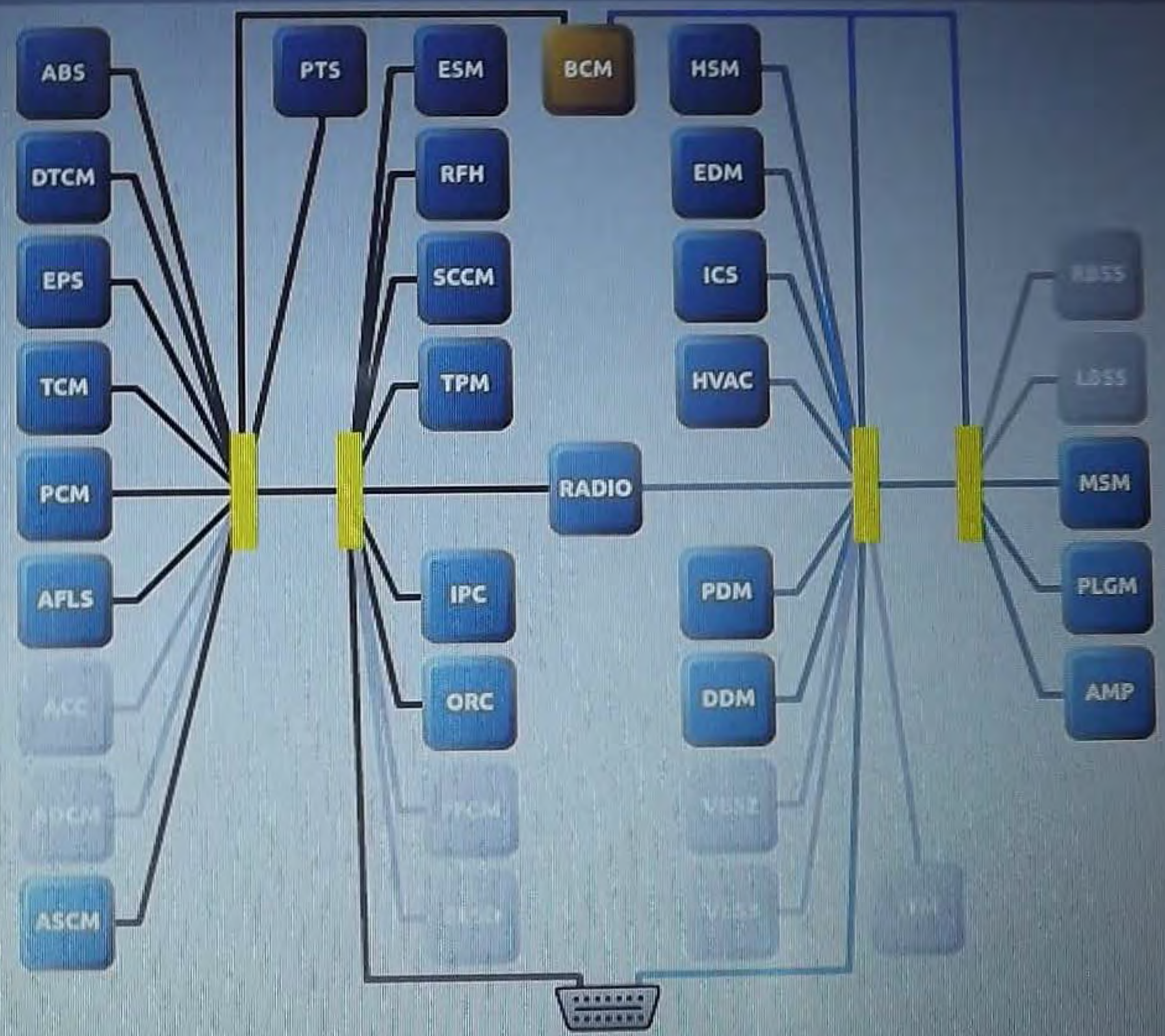

- Non-responsive ECU
- DTCs Present
- ECU Not Built
- Scanning ECU
- New Flash Available
- CAW-C
- CAW-MS



All DTCs | Diagnostic Procedures | Customer Preferences | **Vehicle Preparations**

Double-click row selection to view environmental data. Click on column heading to sort table.

All | Active | Stored | Pending

[View Freeze Frame](#)

ECU	Code	Status	Description
BCM	B16DF-15	stored	Right Tailamp 1 Control-Circuit Short to Battery or Open
BCM	B16E7-15	stored	License Plate Lamp Control-Circuit Short to Battery or Open
BCM	B16B7-15	stored	Center Stop Lamp Control-Circuit Short to Battery or Open

login **Offline**

Ask me anything

- Taskbar icons: File Explorer, Edge, Mail, Photos, OneDrive, Word, PowerPoint, Teams, Chrome, etc.

Overview

Name:

Electronic Shifter

Flash Part Number:

68166105AE

Bus Type:

CAN C

Hardware Version:

11.23.00

Software Version:

#1: 13.08.00 ,#0: 13.08.00

Spare Part Number:

N/A

ISO Code:

Software Number:

N/A

Hardware Number:

N/A

Original VIN

1C4RJFCG5EC [REDACTED]

Current VIN

1C4RJFCG5EC [REDACTED]

Variant & Version:

42 - 1

Country Code

N/A

DTC Count:

~

Note: Please review all available service documentation (SB's, RRT's system) to NOT function properly!

Login

Off-line

Ask me anything

ECM View

- Flash
- Data
- DTCs
- Actuators
- System Tests
- Misc Functions
- ECU Details

Double-click row selection to graph data element, or check multiple elements and press "Show Graph". Click on column heading to sort table. Drag and drop row or multiple row selections to re-order table elements.

Graph	Name	Value	Unit	Type
<input type="checkbox"/>	Vehicle Battery Voltage	13.5	Volts	Sensors
<input checked="" type="checkbox"/>	Park LED	4.0196078431	Volts	Sensors
<input checked="" type="checkbox"/>	Reverse LED	0.0000000000	Volts	Sensors
<input checked="" type="checkbox"/>	Drive LED	0.0000000000	Volts	Sensors
<input checked="" type="checkbox"/>	Autostick LED	0.4509803922	Volts	Sensors
<input type="checkbox"/>	Position 0 (Idle) / INIT Position after start	Not Set		Sensors
<input type="checkbox"/>	Position 6 (Mid Position) POS ZERO	Set		Sensors
<input type="checkbox"/>	POS ONE Foreward 3	Not Set		Sensors
<input type="checkbox"/>	POS TWO Foreward 2	Not Set		Sensors
<input type="checkbox"/>	POS THREE Foreward 1	Not Set		Sensors
<input type="checkbox"/>	POS FOUR Backward 1	Not Set		Sensors
<input type="checkbox"/>	POS FIVE Backward 2	Not Set		Sensors
<input type="checkbox"/>	POS SIX Backward 3	Not Set		Sensors
<input type="checkbox"/>	Relase Button one	Not Set		Sensors
<input type="checkbox"/>	Release Button 2	Not Set		Sensors
<input type="checkbox"/>	Neutral LED	0.0000000000	Volts	Sensors

Overview

Name:
Electronic Shifter
Flash Part Number:
8166105AE
Bus Type:
CAN C
Hardware Version:
23.00
Software Version:
13.08.00 ,#0: 13.08.00
Part Number:
Code:
Part Number:
Part Number:
VIN
CGSEC
VIN
CGSEC
& Version:
Code

Double-click row selection to graph data element, or check multiple elements and press "Show Graph". Click on column heading to sort table. Drag and drop row or multiple row selections to re-order table elements.

Graph	Name	Value	Unit	Type
<input type="checkbox"/>	Vehicle Battery Voltage	13.5	Volts	Sensors
<input checked="" type="checkbox"/>	Park LED	0.0000000000	Volts	Sensors
<input checked="" type="checkbox"/>	Reverse LED	3.9811984366	Volts	Sensors
<input checked="" type="checkbox"/>	Drive LED	0.0000000000	Volts	Sensors
<input checked="" type="checkbox"/>	Autostick LED	0.4509803922	Volts	Sensors
<input type="checkbox"/>	Position 0 (Idle) / INIT Position after start	Not Set		Sensors
<input type="checkbox"/>	Position 6 (Mid Position) POS ZERO	Set		Sensors
<input type="checkbox"/>	POS ONE Foreward 3	Not Set		Sensors
<input type="checkbox"/>	POS TWO Foreward 2	Not Set		Sensors
<input type="checkbox"/>	POS THREE Foreward 1	Not Set		Sensors
<input type="checkbox"/>	POS FOUR Backward 1	Not Set		Sensors
<input type="checkbox"/>	POS FIVE Backward 2	Not Set		Sensors
<input type="checkbox"/>	POS SIX Backward 3	Not Set		Sensors
<input type="checkbox"/>	Release Button one	Not Set		Sensors
<input type="checkbox"/>	Release Button 2	Not Set		Sensors
<input type="checkbox"/>	Neutral LED	0.0000000000	Volts	Sensors



TECH

Double-click

- Name
- Configur
- ECU Deb
- Event Da
- Freeze Fr
- Inhibit M
- Loss Of C

Vehicle Information

Vehicle 2014 WK 3.6L

Odometer 41854.9 miles

VIN 1C4RJFCG5EC [REDACTED]

Original VIN 1C4RJFCG5EC [REDACTED]

Publication Date Thu Aug 20 2015

- Vehicle S
- Vehicle S

DTCM	Drive Train Control Module	1C4RJFCG5EC [REDACTED]	1C4RJFCG5EC2 [REDACTED]
EDM	External Disc Module	1C4RJFCG5EC [REDACTED]	1C4RJFCG5EC2 [REDACTED]
EP5	Electric Power Steering	1C4RJFCG5EC [REDACTED]	1C4RJFCG5EC2 [REDACTED]
E5M	Electronic Shifter	1C4RJFCG5EC [REDACTED]	1C4RJFCG5EC2 [REDACTED]

Vehicle Scan Report

TECH

Double-click

Name

Configur

ECU Deb

Event Da

Freeze Fr

Inhibit M

Loss Of C

Vehicle S

Vehicle S

Vehicle Information

Vehicle 2014 WK 3.6L

Odometer 41854.9 miles

VIN 1C4RJFCG5EC [REDACTED]

Original VIN 1C4RJFCG5EC [REDACTED]

Publication Date Thu Aug 20 2015

DTCM	Drive Train Control Module	1C4RJFCG5EC [REDACTED]	1C4RJFCG5EC [REDACTED]
EDM	External Disc Module	1C4RJFCG5EC [REDACTED]	1C4RJFCG5EC [REDACTED]
EPS	Electric Power Steering	1C4RJFCG5EC [REDACTED]	1C4RJFCG5EC [REDACTED]

Click on the buttons to view the desired information. Click on column heading to sort table.

Environmental Data for BCM | B16B7-15 Center Stop Lamp Control-Circuit Short to Battery or Open

Snapshot Data

Name	Value	Units
Test Failed	False	
Test Failed This Operation Cycle	False	
Pending DTC	False	
Confirmed DTC	True	
Test Not Completed Since Last Clear	False	
Test Failed Since Last Clear	True	
Test Not Completed This Operation Cycle	False	

A A

Disconnect

Warnings: 0 Errors: 0

10:59 AM
8/20/2015

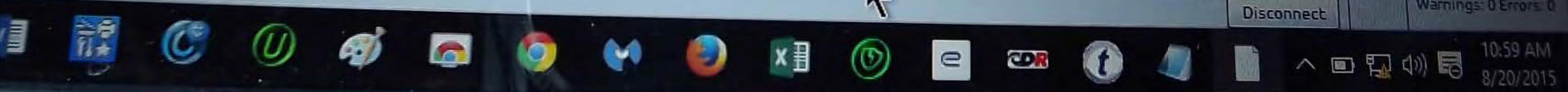

sort table.

View Event Data Clear Stored DTCs

- Short to Battery or Open
- Short to Battery or Open
- Short to Battery or Open
- Short to Battery or Open

Click on the buttons to view the desired information. Click on column heading to sort table.

Environmental Data for BCM | B16B7-15 Center Stop Lamp Control-Circuit Short to Battery or Open

Name	Value	Units
Warning Indicator Requested	False	
DTC Extended Data Record Number - All	01	
Occurrence flag	Error	
Original Odometer Value	40981	miles
Most Recent Odometer Value	40981	miles
Frequency Counter	1	
Ignition Cycle Counter	87	

Disconnect Warnings: 0 Errors: 0



Click on the buttons to view the desired Information. Click on column heading to sort table.

Environmental Data for BCM | B16E7-15 License Plate Lamp Control-Circuit Short to Battery or Open

Name	Value	Units
Test Failed	False	
Test Failed This Operation Cycle	False	
Pending DTC	False	
Confirmed DTC	True	
Test Not Completed Since Last Clear	False	
Test Failed Since Last Clear	True	
Test Not Completed This Operation Cycle	True	

A A

Disconnect

Warnings: 0 Errors: 0

11:00 AM
8/20/2015

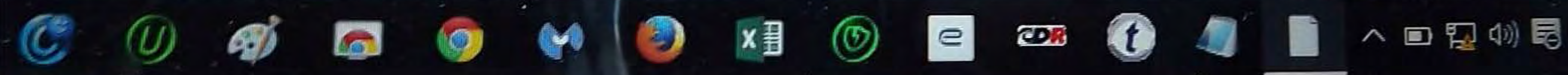

Click on the buttons to view the desired information. Click on column heading to sort table.

Environmental Data for BCM | B16E7-15 License Plate Lamp Control-Circuit Short to Battery or Open

Name	Value	Units
Test Not Completed This Operation Cycle	True	
Warning Indicator Requested	False	
DTC Extended Data Record Number - All	01	
Occurrence Flag	Error	
Original Odometer Value	40981	miles
Most Recent Odometer Value	40981	miles
Frequency Counter	1	

A A

Disconnect

Warnings: 0 Errors: 0

11:01 AM
8/28/2015

2014 WK 3.6L
VIN: 1CARJPCGSEY [REDACTED]
Battery: 13.386 volts

- Legend
- Active ECU
 - Non-responsive ECU
 - DTCs Present
 - ECU Not Built
 - Scanning ECU
 - New Flash Available
 - CAN-C
 - CAN-IHS

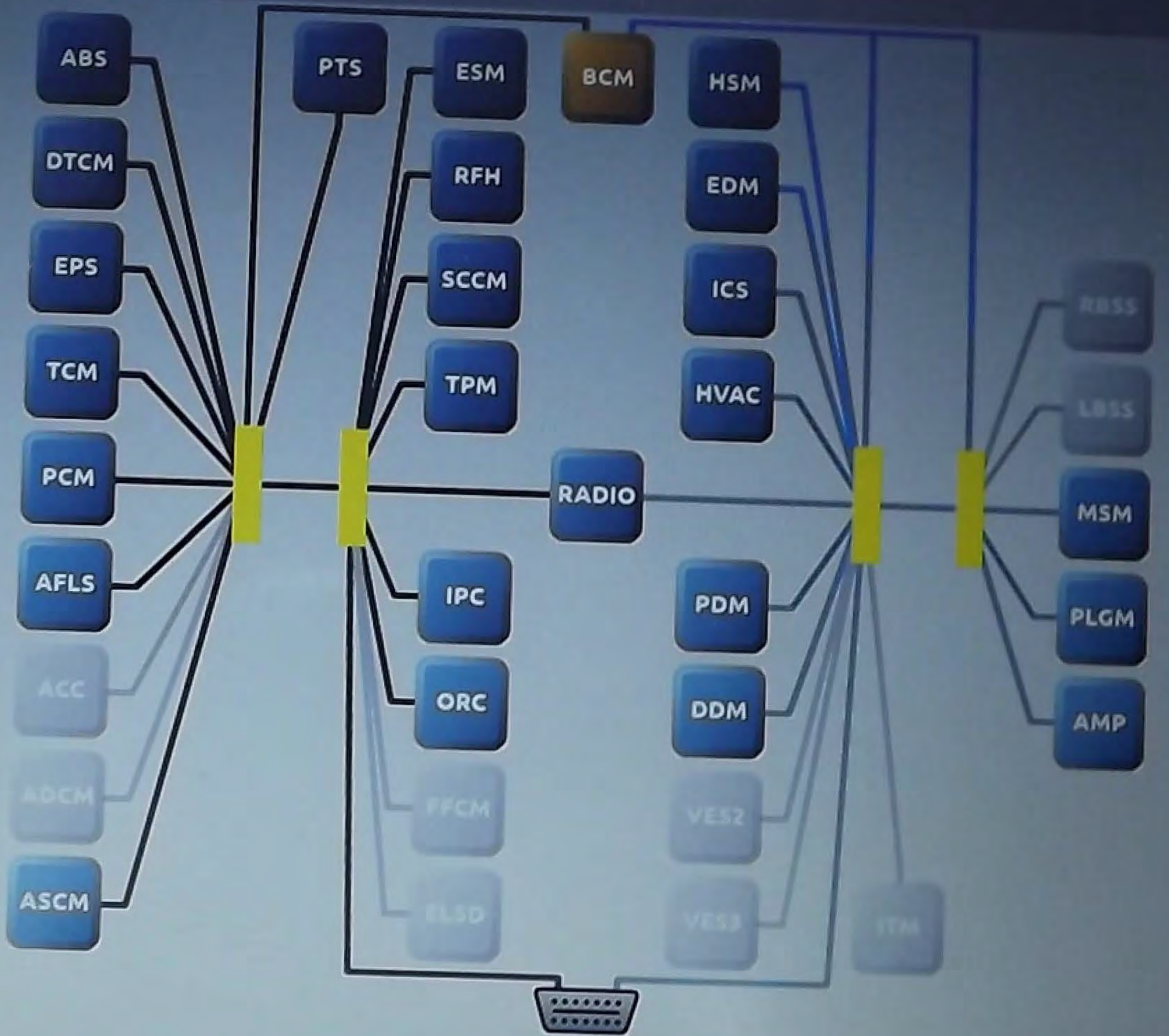

Log in **Off-line**

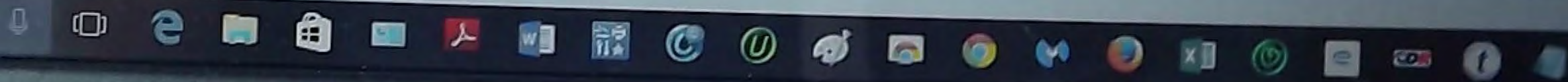

11:01 AM 8/29/2013

83°F

0

MPH

SW



Already in
Desired Gear

S
D
N
R
P

41854 mi





V6

GM1344

