

INFORMATION Redacted PURSUANT TO THE FREEDOM OF  
INFORMATION ACT (FOIA), 5 U.S.C . 552(B)(6)

EA12-001

CHRYSLER

10-4-2012

ENCLOSURE 4

FIELD DATA SUBJECT

CAIRs Backup



20

180

110

200

120

MPH km/h

TYPE 35

131976



MFD BY DAIMLERCHRYSLER  
CORPORATION

DATE OF MFR  
10-01

GVWR  
2405 KG(05300 LB)

GVWR FRONT	WITH TIRES	RIMS AT	COLD
1180 KG(2600 LB)	P215/75SR16	16X7	227 KPA(33 PSI)
GVWR REAR	WITH TIRES	RIMS AT	COLD
1339 KG(2950 LB)	P215/75SR16	16X7	227 KPA(33 PSI)

THIS VEHICLE CONFORMS TO ALL APPLICABLE FEDERAL MOTOR VEHICLE SAFETY AND THEFT PREVENTION STANDARDS IN EFFECT ON THE DATE OF MANUFACTURE SHOWN ABOVE.

VIN: 1J4GK48K02W [REDACTED] TYPE: MPV SINGLE X DUAL



MDH: 102013 387AA PNT:PGR VEHICLE MADE IN U.S.A. TRM:M5L5 4648503

AIR  
BAG







TRANS  
TEMP

13 1976























Publix

















LIBERTY SPORT

ROAD VENTURE AT  
GOODYEAR









LIBERTY sport

MAGNACORE OVERNATURE AT

Community Center





3.7L

DUNLOP M/T TERRAPLUS  
© 2000





Jeep

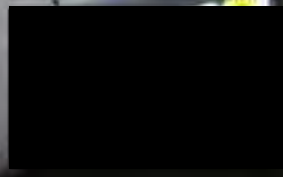



















# **! WARNING**

## **DEATH OR SERIOUS INJURY CAN OCCUR**



- CHILDREN 12 AND UNDER CAN BE KILLED BY THE AIR BAG.
- THE **BACK SEAT** IS THE **SAFEST** PLACE FOR CHILDREN.
- **NEVER** PUT A REAR-FACING CHILD SEAT IN THE FRONT.
- SIT AS FAR BACK AS POSSIBLE FROM THE AIR BAG.
- **ALWAYS** USE **SEAT BELTS** AND **CHILD RESTRAINTS**.



**! WARNING: HIGHER ROLLOVER RISK**



AVOID ABRUPT MANEUVERS  
AND EXCESSIVE SPEED.

ALWAYS BUCKLE UP.

SEE OWNER'S MANUAL  
FOR FURTHER INFORMATION.





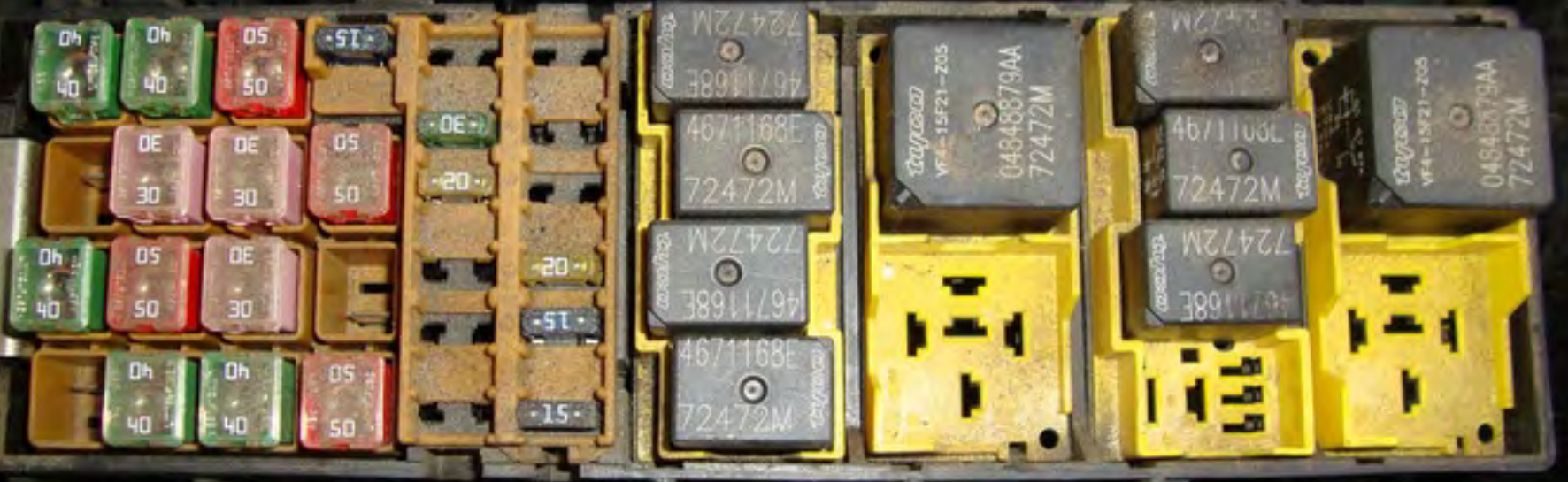



BLOWER MOTOR 1 40A	RADIATOR FAN 2 40A	JB POWER 3 50A	
ABS PUMP 4 40A	EATX 5 30A	ASD 6 30A	JB POWER 7 50A
IGNITION/ START 8 40A	JB POWER 9 50A	TRAILER TOW 10 30A	11
LIGHT BAR 12 30A	IGNITION/ WINDOWS 13 40A	IGNITION/ SWITCH 14 40A	JB POWER 15 50A

ASD FEED 16	15A	17	18
----------------	-----	----	----

HBL 19	30A	20
-----------	-----	----

A/C CLUTCH 21	20A	22
------------------	-----	----

23	FUEL PUMP 24	20A
----	-----------------	-----

ABS VALVES 25	20A	INJECTORS 26	15A
------------------	-----	-----------------	-----

27	STARTER RELAY 28	15A
----	---------------------	-----

FUEL PUMP  
29

STARTER  
30

WIPER ON/OFF  
31

WIPER HI/LO  
32

BLOWER MOTOR  
33

34

A/C CLUTCH  
35

REAR O2 SENSOR  
36

EATX/CLUTCH INTERLOCK  
37

38

ASD  
39

40

4671168E

4671168E

72472M

4671168E





MADE IN USA  
**JOHNSON**  
MAGNETIC  
ANGLE  
*Locator*  
NO. 709









33008410E 3 



TC187



TRW

33014254-D (19)



DAIMLER CHRYSLER



P5HG331L8AE



TR1284106695



**TRW**

H01-07

414011R

**MEETS FMVSS 209**  
**ASSEMBLED IN MEXICO**



8 TRW

33008997A

413011



























T5041



TR 77

33014254-D

23



DAIMLER CHRYSLER

P5HG341L8AE

02275100105



**IRV**

H01-06

401013R

MEETS FMVSS 209

ASSEMBLED IN MEXICO



412012

011111



TC 187



33008410E8 



6 11 11 33008997A  
613011













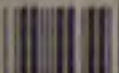

\*TCOPT



85172377\*



\*P5531



020AH\*



\*HERST

LLUNGSJAHR: 2001\*

Airbag  
 Einbaueinheit  
 VPE/PHG  
 Hersteller: IPVA/MSI  
 Werk: Opel AG  
 Herstellungsort: RWP-5  
 Einführer: z.B. Chrysler  
 Deutschland GmbH,  
 Kopen  
 Telefon: 0273/967211  
 BAM-PT1-0639

Umgang nur durch geschultes  
 Personal erlaubt. Verwendung  
 nur in Instandsetzungs-  
 Rüstsystemen mit Luft sack  
 für Kraftfahrzeuge erlaubt.  
 Bei Auslösung kann die nicht  
 montierte Airbag-Einheit  
 zum gefährlichen Wurfstück  
 werden.

Supplemental Restraint System (SRS) Module

Use only a specified  
 Supplemental  
 Restraint System.  
 See DaimlerChrysler  
 Corp. dealer to verify  
 part number for this  
 vehicle.

**WARNING**

You could be injured  
 due to unwarned inflation. To help  
 avoid personal injury:  
 1. Do not take apart, crush  
 or puncture.  
 2. Carefully follow instructions  
 in the DaimlerChrysler Corp.  
 Service Manual when perform-  
 ing any type of service or when  
 disposing of this module.

















\*TCOPT



85172377\*



\*P5531



020AH\*



\*HERST

ELLUNGSJAHR:

2001\*









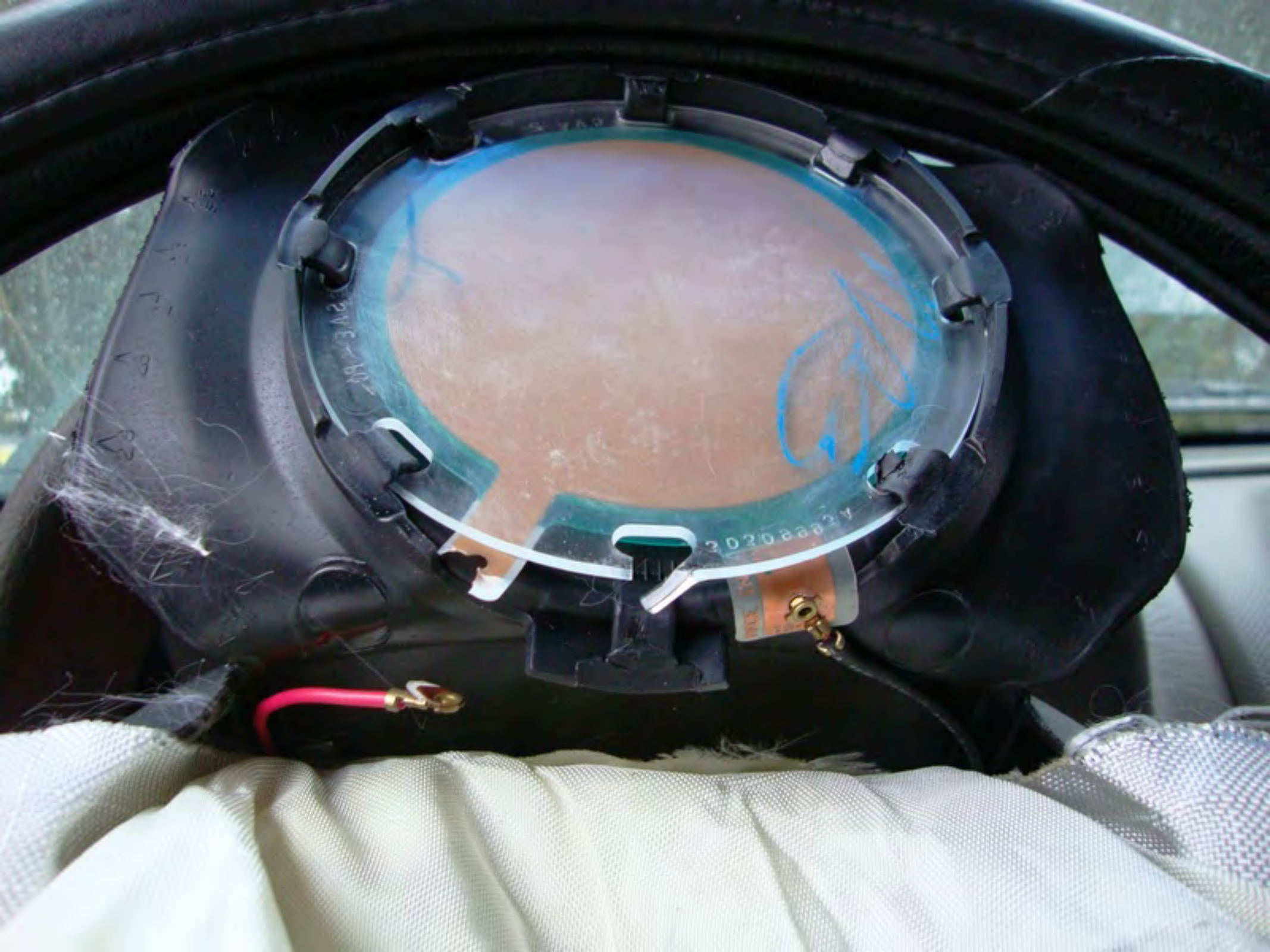

































+Battery

LIBERTY MUTUAL  
OFFICE  
3801 Pioneer Park Dr  
Tampa, FL 33618  
ISSUING OFFICE  
Liberty Mutual  
150 Liberty Way  
PO Box 5055  
Dover, NH 03821



PRESSURE  
BEFORE RUNNING  
PRESSURE IF  
WARM

TION PRESSURE  
IZES  
(YSPARE)  
33psi/227

SEE OWNERS MANUAL FOR  
HIGH SPEED OPERATION  
AND ADDITIONAL DATA



F  
FUNCTION

DISC/P.CH

AUDIO

ESCAPE

SELECT

ATT

-

+

TRACK/SEEK

MISREPRESENTATION OF  
DEGREE MISREPRESENTATION  
RENTAL CAR COVERAGE IS  
OF COVERAGE.





+Battery

TIRE INFLATION PRESSURE  
INFLATE TIRES COLD BEFORE RUNNING  
DO NOT REDUCE PRESSURE IF  
TIRES ARE WARM

RECOMMENDED INFLATION PRESSURE AND TIRE SIZES (INCLUDING POLYSPARE)	
P215/75R16	33psi/227 kPa
P215/75D16	33psi/227
P235/70R16	

SEE GV  
HIGH  
AND A







POWER SUPPLY

TO iPod

**Pioneer**

**CD-IB100**

iPod ADAPTER

IP-BUS IN

IP-BUS OUT

USE THE REVERSE SIDE OF THIS LABEL FOR WIRING INFORMATION  
AND NOT THE REVERSE SIDE OF THE UNIT ITSELF  
RECOMMENDED WIRE GAUGE (AWG) AND STRIP LENGTH (MM)  
SEE CHANGING MANUAL FOR  
HIGH SPEED OPERATION  
AND ADJUSTMENTS



POWER SUPPLY

**Pioneer**

**CD-IB100**

IPod ADAPTER

IP-BUS IN

IP-BUS OUT





107 385850  
EPS 582739514M  
7 2 8402284 1 0906

1 2 282

2212112





**Pioneer**

**CD-IB100**

DC./C.C./c.c. 12V

⊖ GROUND / ⊖ MASSE

SPEC NO. / NO. DE LOT

**XM/E**

SERIAL NO./NO. DE SERIE



EC

**e13**



**N838**

**022654**

**PIONEER CORPORATION**

MADE IN MALAYSIA/FABRIQUÉ EN MALAISIE

<CZA6602-A>



+バッテリー  
+Battery

<CRW1391-A>

**Pioneer**  
DC/C.C./e.c. 12V  
SPEC. NO. / NO. DE LOT  
SERIAL NO. / NO. DE SERIE  
FC  
EC  
**CD-IB100**  
- GRND / - MASSE







HERSTELLUNGSJAHR: 8 75\*

Yellow label with illegible text, possibly a warning or technical specification.











DROD1 288







































# Tallahassee

Dodge - Chrysler - Jeep

THE STATE OF FLORIDA  
REGISTERED PROFESSIONAL MECHANIC

3987 W. Tennessee Street  
TALLAHASSEE, FL 32304 (850) 576-4111

CELL: 727-204-5505

NAME: PAUL FALZONE	3139	2374	12/01/09	CHCS105845
LABOR RATE		120,838	/	
VEHICLE MAKE/MODEL	07/JEEP/LIBERTY/2WD SPORT			
VEHICLE TO NO	1 J 4 G K 4 8 K D 2 W			
DATE	11/30/09			

MO: 120843

**DISCLAIMER OF WARRANTIES**

Any warranties on the product sold hereby are those made by the manufacturer. The Seller hereby expressly disclaims all warranties, either express or implied, including any implied warranty of merchantability or fitness for a particular purpose, and neither assumes nor authorizes any other person to assume for it any liability in connection with the sale of said products.

JOB # 1 CHANGES

LABOR	DESCRIPTION	UNIT PRICE	TOTAL
	TECH(S):3208		123.45
	ENGINE OIL AND OIL FILLER HOUSING SEAL LEAKING. NEW OIL FILLER HOUSING SEAL.		
	DESCRIPTION: GASKET OIL 9001004	10.10	
	TOTAL - PARTS	10.10	
	LABOR		123.45
	PARTS		10.10
	<b>JOB # 1 TOTAL</b>		<b>133.55</b>

JOB # 2 CHANGES

LABOR	DESCRIPTION	UNIT PRICE	TOTAL
	TECH(S):3208		0.00
	24 POINT INSPECTION. COMPLETE MULTIPoint INSPECTION, COMPLETE INSPECTION SHEET AS PER CUSTOMER REQUEST. PERFORM FREE MULTI POINT INSPECTION, INSPECT SPECIFIC AREAS AROUND THE CUSTOMERS PRIME CONCERN TO DETERMINE IF ANY OTHER SERVICES OR REPAIRS ARE NEEDED.		
	<b>JOB # 2 TOTAL</b>		<b>0.00</b>

JOB # 3 CHANGES

LABOR	DESCRIPTION	UNIT PRICE	TOTAL
	TECH(S):3208		6.20
	PERFORM OIL CHANGE ON NEW ENGINE VEHICLE USING REQUIRED FACTORY APPROVED OIL TO COMPLY WITH ENGINE WARRANTY. CHANGE OIL AND FILTER. TOP OFF ALL FLUIDS AND PERFORM 16PT INSPECTION. REPLACED OIL AND FILTER AND TOPPED OFF FLUIDS AS NEEDED OPERATES AS DESIRED AT THIS TIME.		
	DESCRIPTION: OIL 5W20 1081090	1.88	
	DESCRIPTION: FILTER ENG 9057006	4.35	
	TOTAL - PARTS		13.75
	LABOR		6.20
	PARTS		13.75
	<b>JOB # 3 TOTAL</b>		<b>19.95</b>

LABOR

	TECH(S):3208		6.20
	<b>JOB # 3 TOTAL</b>		<b>19.95</b>





NAME OF CUSTOMER: [REDACTED]  
 ADDRESS: [REDACTED]  
 PHONE: [REDACTED]  
 MAKE: Jeep MODEL: Liberty

Call the Installation Center for an installing appointment.

QTY	SKU #	PRICE	MODEL NO
1		349 <sup>99</sup>	501S
1		239 <sup>99</sup>	DPM 06500
1		109 <sup>00</sup>	Ju
1		3 <sup>99</sup>	Leads
1		16 <sup>99</sup>	Kit
1		16 <sup>99</sup>	Harvests
1		10 <sup>99</sup>	Ant Adapter
1		79 <sup>99</sup>	Ampl Kit & Scrup
1		59 <sup>99</sup>	Sub Box Divider
2		13 <sup>99</sup> ea	4 pin Service on Site
	481023	400	Material Fee
	034108		In-Dash Unit Only
	034031		Tier Speakers Only
	120106	55 <sup>99</sup>	Two Channel Amplifier (In Trunk or Under Seat)
	044060		Four Channel Amplifier (In Trunk or Under Seat)
	034064		Compact Disc Changer (without RF Modulator)
	034063		Compact Disc Changer (with RF Modulator)
	034067		Custom Labor

SPECIAL INSTRUCTIONS: Open Trunk Subs and Box Complete  
Free Install and punch speakers  
in Trunk and install a panel on  
 [Signature]  
 MANAGER

MOBILE TO BUY BY 1988  
 1988-1989  
 1987-1988

CALL FOR FLOW-DOWN  
 1988 AND 1989 LISTED

1987	1988	
1988	1989	
1989	1990	
1990	1991	
1991	1992	
1992	1993	
1993	1994	
1994	1995	
1995	1996	
1996	1997	
1997	1998	
1998	1999	
1999	2000	
2000	2001	
2001	2002	
2002	2003	
2003	2004	
2004	2005	
2005	2006	
2006	2007	
2007	2008	
2008	2009	
2009	2010	
2010	2011	
2011	2012	
2012	2013	
2013	2014	
2014	2015	
2015	2016	
2016	2017	
2017	2018	
2018	2019	
2019	2020	
2020	2021	
2021	2022	
2022	2023	
2023	2024	
2024	2025	
2025	2026	
2026	2027	
2027	2028	
2028	2029	
2029	2030	
2030	2031	
2031	2032	
2032	2033	
2033	2034	
2034	2035	
2035	2036	
2036	2037	
2037	2038	
2038	2039	
2039	2040	
2040	2041	
2041	2042	
2042	2043	
2043	2044	
2044	2045	
2045	2046	
2046	2047	
2047	2048	
2048	2049	
2049	2050	
2050	2051	
2051	2052	
2052	2053	
2053	2054	
2054	2055	
2055	2056	
2056	2057	
2057	2058	
2058	2059	
2059	2060	
2060	2061	
2061	2062	
2062	2063	
2063	2064	
2064	2065	
2065	2066	
2066	2067	
2067	2068	
2068	2069	
2069	2070	
2070	2071	
2071	2072	
2072	2073	
2073	2074	
2074	2075	
2075	2076	
2076	2077	
2077	2078	
2078	2079	
2079	2080	
2080	2081	
2081	2082	
2082	2083	
2083	2084	
2084	2085	
2085	2086	
2086	2087	
2087	2088	
2088	2089	
2089	2090	
2090	2091	
2091	2092	
2092	2093	
2093	2094	
2094	2095	
2095	2096	
2096	2097	
2097	2098	
2098	2099	
2099	2100	
2100	2101	
2101	2102	
2102	2103	
2103	2104	
2104	2105	
2105	2106	
2106	2107	
2107	2108	
2108	2109	
2109	2110	
2110	2111	
2111	2112	
2112	2113	
2113	2114	
2114	2115	
2115	2116	
2116	2117	
2117	2118	
2118	2119	
2119	2120	
2120	2121	
2121	2122	
2122	2123	
2123	2124	
2124	2125	
2125	2126	
2126	2127	
2127	2128	
2128	2129	
2129	2130	
2130	2131	
2131	2132	
2132	2133	
2133	2134	
2134	2135	
2135	2136	
2136	2137	
2137	2138	
2138	2139	
2139	2140	
2140	2141	
2141	2142	
2142	2143	
2143	2144	
2144	2145	
2145	2146	
2146	2147	
2147	2148	
2148	2149	
2149	2150	

CUSTOMER SIGNATURE: [REDACTED]



CUSTOMER NAME  
 ADDRESS  
 CITY, STATE, ZIP  
 HOME PHONE  
 WORK PHONE

MOBILE ELECTRONICS - MOBILE INSTALLATION



Vehicle: Year \_\_\_\_\_ Make \_\_\_\_\_ Model Truck  
 Call the Installation Center for an installation appointment.

QTY	SKU #	PRICE	MODEL NO.
		2999	4Yr Service Amp
		3999	4Yr Service Pack
	4081903		Materials Fee
	0349108		In-Dash Unit Only
	0349331		Two Speakers Only
	1239136		Two Channel Amplifier (In Trunk or Under Seat)
	0949340		Four Channel Amplifier (In Trunk or Under Seat)
	0349054		Compact Disc Changer (without RF Modulator)
	1362493		Compact Disc Changer (with RF Modulator)
	0949072		Custom Labor

4711565	4YR CAR SIR	19.99
4YR CAR SUBWOOFER PSP		
PSP #	2131538773	
SKU #	5497376	
1980869	CAR CD 4YR	39.99
4YR CAR CD TR CHANGER		
PSP #	2131539749	
SKU #	5259025	
1980887	CARMP 4YR	29.99
4YR CAR AMP/EO/MTSC PSP		
PSP #	2131540783	
SKU #	5271903	

SUBTOTAL 1,190.04  
 SALES TAX 7.00 X 03.30  
 TOTAL 1,273.34  
 CASH 900.00  
 DEBIT 373.34

XXXXXXXXXXXXXXXXXXXX  
 MATT SHAWDY  
 EXP 10/05 APPROXIM  
 REFERENCE NUMBER: 046200700324

1 PSP #2131540628  
 MATT SHAWDY

BASE CHARGES DO NOT INCLUDE  
 MATERIALS FEES, EXTENSIVE LABOR,  
 MATERIALS FEE, OR ANY CUSTOM  
 MODIFICATIONS.  
 INSTALLATION CHARGES MAY VARY  
 DEPENDING UPON INDIVIDUAL VEHICLES  
 AND WILL BE  
 FINALIZED UPON INSPECTION.

SPECIAL INSTRUCTIONS  
 6/1 PURCHASES MADE NOVEMBER 1 - DECEMBER  
 7/1 2003 WITH IT'S FOR AN 1 - RECEIVERS  
 FRTICY COMPACTS, CTR AND NOTBOOKS DO  
 NOT QUALIFY FOR THIS EXTENDED SERVICE  
 RECEIPT AND POSTED IN THE STORE. I HAVE  
 RECEIVED GOODS AND/OR SERVICES IN THE  
 AMOUNT SHOWN ABOVE

CUSTOMER RECEIPT YELLOW & GOLD  
 RECEIPT FOR INSTALLATION  
 HAVE RECEIVED AND APPROVED PURCHASE AND  
 RETURN TO THE BACK OF THIS

























WEIGHT CAPACITY 5000 500  
RAMP POINT  
WARNING DO NOT CUT, DRILL, WELD OR MODIFY  
V-5  
MADE IN U.S.A.

75128

STATE MATHS











TR2VE2821A0695  
P56010319A8  
307540



This Diagnostic Control  
Module is not supported by  
this software. Please use the  
DRB III with the Supercard  
software to diagnose this  
vehicle.

F1  
HELP

F2  
SYS

F3  
MAIN

64.1



DRB III CDRB Application  
Chrysler Corp.

Copyright © 1993-2006

All Rights Reserved

RELEASE 64.1 01

Released: 15:51:24 10/11/2007

Bios Version: 4.02

Database: 8:18:38 7/19/2007

Cable in use: J1962 (CH7000A)





# SELECT FUNCTION

1. System Tests
2. Read DTCs
3. Module Display
4. Sensor Display
5. Input/Output Display
6. Monitor Display
7. Custom Display
8. Actuator Tests
9. Miscellaneous

Page 1 of 1

BCM

F1  
HELP

F2  
SYS

F3  
MAIN



-- BCM DTCs --

NO DTCs DETECTED

Page back to exit



# SELECT FUNCTION

- 1. System Tests
- 2. Read DTCs
- 3. Module Display
- 4. Sensor Display
- 5. Input/Output Display
- 6. Monitor Display
- 7. Custom Display
- 8. Actuator Tests
- 9. Miscellaneous

F1  
HELP

F2  
SYS

F3  
MAIN

64.1



-- MIC DTCs 1 of 1 --

NO ORC BUS  
MESSAGES RECEIVED



Electro/Mech Cluster

Software Version 6.4  
KJ Body

Part #: 56010151AH  
Airbag Present  
W/Tach  
Gas



EA12-001

CHRYSLER

10-4-2012

ENCLOSURE 4

FIELD DATA SUBJECT

CAIRs Backup



1J4GK48K52W



CORPORATION

5-02

2427 KG

GAWR FRONT

WITH TIRES

RIMS AT

COL

1248 KG(2750 LB)

P215/75SR16

16X7

227

GAWR REAR

WITH TIRES

RIMS AT

COLD

1339 KG(2950 LB)

P215/75SR16

16X7

227

THIS VEHICLE CONFORMS TO ALL APPLICABLE FEDERAL MOTOR VEHICLE SAFETY  
 PREVENTION STANDARDS IN EFFECT ON THE DATE OF MANUFACTURE SHOWN A

VIN: 1J4GK4BK52

TYPE:

MPV

SINGLE

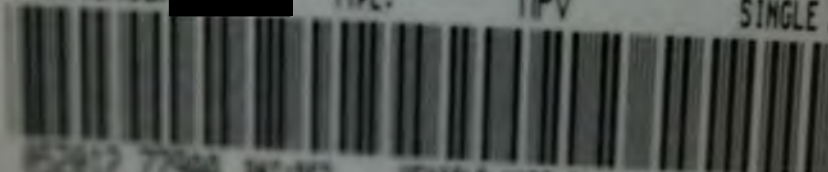

VIN:

052012 779AA INT:MS2

VEHICLE MADE IN U.S.A. TRN:MSDU





































SCARLETT  
KOERNER













18 18" 18"  
19 19" 19"  
20 20" 20"  
21 21" 21"  
22 22" 22"  
23 23" 23"  
24 24" 24"  
25 25" 25"  
26 26" 26"  
27 27" 27"  
28 28" 28"  
29 29" 29"  
30 30" 30"

















































































TC065















































MIC DTGs 1 of 1

NO ORC BUS  
MESSAGES RECEIVED

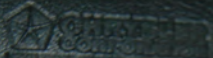

Modules Present on the Bus

PCM  
EATX  
BCM/FCM  
MIC  
Radio

Page 1 of 1

HELP

SYS

HOME





## SELECT RESTRAINT SYSTEM

1. Airbag
2. Side Airbags
3. Airbag On/Off Switch System
4. Occupant Classification Sys

Page 1 of 1

HELP

SYS

MAIN

This Diagnostic Control  
Module is not supported by  
this software. Please use the  
DRB III with the Supercard  
software to diagnose this  
vehicle.

F1  
HELP

F2  
SYS

F3  
MAIN

64.1





**⚠ WARNING**

**DEATH OR SERIOUS INJURY CAN OCCUR**



- CHILDREN OR INFANTS SHOULD NEVER BE KEPT IN THE AIR BAG.
- THE BACK SEAT IS THE SAFEST PLACE FOR CHILDREN.
- NEVER PUT A REAR-FACING CHILD SEAT IN THE FRONT.
- SIT AS FAR BACK AS POSSIBLE FROM THE AIR BAG.
- ALWAYS USE SEAT BELTS AND CHILD RESTRAINTS.

**⚠ WARNING: HIGHER ROLLOVER RISK**



AVOID ABRUPT MANEUVERS AND EXCESSIVE SPEED.

ALWAYS BUCKLE UP

SEE OWNER'S MANUAL FOR FURTHER INFORMATION.





**⚠ WARNING**

**DEATH OR SERIOUS  
INJURY CAN OCCUR**



- CHILDREN 12 AND UNDER CAN BE KILLED BY THE AIR BAG.
- THE BACK SEAT IS THE SAFEST PLACE FOR CHILDREN.
- NEVER PUT A REAR-FACING CHILD SEAT IN THE FRONT.
- SIT AS FAR BACK AS POSSIBLE FROM THE AIR BAG.
- ALWAYS USE SEAT BELTS AND CHILD RESTRAINTS.











 ROTARY LIFT









ROTARY

100

EA12-001

CHRYSLER

10-4-2012

ENCLOSURE 4

FIELD DATA SUBJECT

CAIRs Backup









164

Jeep





164

Jeep

Jeep

STANBRO  
R1000





CUSTOMER  
PARKING

CUSTOMER  
PARKING

LIBERTY LIMITED

RADIAL SUV  
STAMPEDE

RADIAL SUV  
STAMPEDE



CUSTOMER  
PARKING

ED TOMKO

CHRYSLER

Jeep



AVON LAKE - OH

3.7L

STAMPED





ED TOMKO

CHRYSLER

Jeep



AVON LAKE - OH

EdTomko  
CHRYSLER-JEEP INC.  
AVON LAKE, OH  
Jeep  
4x4

3.7L









ED TOMKO

CHRYSLER

Jeep



AVON LAKE - OH

Ed Tomko  
CHRYSLER-JEEP INC.  
AVON LAKE, OHIO

Jeep  
4x4

18 AVON

RADIAL AIR  
STAMPED









164

Jeep

LIBERTY

RADIAL SUV





STAMPED

RADIAL SUV







MFD BY DAIMLERCHRYSLER CORPORATION DATE OF MFR 4-02 GVWR 2541 KG(05600 LB)

GVWR FRONT	WITH TIRES	RIMS AT	COLD
1248 KG(2750 LB)	235/70R16	16X7	227 KPA(33 PSI)
GVWR REAR	WITH TIRES	RIMS AT	COLD
1429 KG(3150 LB)	235/70R16	16X7	227 KPA(33 PSI)

THIS VEHICLE CONFORMS TO ALL APPLICABLE FEDERAL MOTOR VEHICLE SAFETY AND THEFT PREVENTION STANDARDS IN EFFECT ON THE DATE OF MANUFACTURE SHOWN ABOVE.

VIN: 1J4GL58K02W [REDACTED] TYPE: MPV SINGLE X DUAL



MDH: 042618 779AA PNT:PS2 VEHICLE MADE IN U.S.A. TRM:DLD2 4648503



MFD BY DAIMLERCHRYSLER  
CORPORATION

DATE OF MFR  
4-02

GVWR  
2541 KG(05600 LB)

GAWR FRONT	WITH TIRES	RIMS AT	COLD
1248 KG(2750 LB)	235/70R16	16X7	227 KPA(33 PSI)
GAWR REAR	WITH TIRES	RIMS AT	COLD
1429 KG(3150 LB)	235/70R16	16X7	227 KPA(33 PSI)

THIS VEHICLE CONFORMS TO ALL APPLICABLE FEDERAL MOTOR VEHICLE SAFETY AND THEFT PREVENTION STANDARDS IN EFFECT ON THE DATE OF MANUFACTURE SHOWN ABOVE.

VIN: 1J4GL58K02V [REDACTED] TYPE: MPV SINGLE X DUAL



MDH: 042618 779AA PNT:PS2 VEHICLE MADE IN U.S.A. TRM:DLD2 4648503





58K02W

AMATS



1J4GL58K02W







IMPED





164

YOU!  
ASURE





ON • OFF  
CRUISE  
SET

50 80 70 80 90 100 110 120

PULL MIST  
MIST





AIR BAG







PART  
TIME

TYPE 35

144481



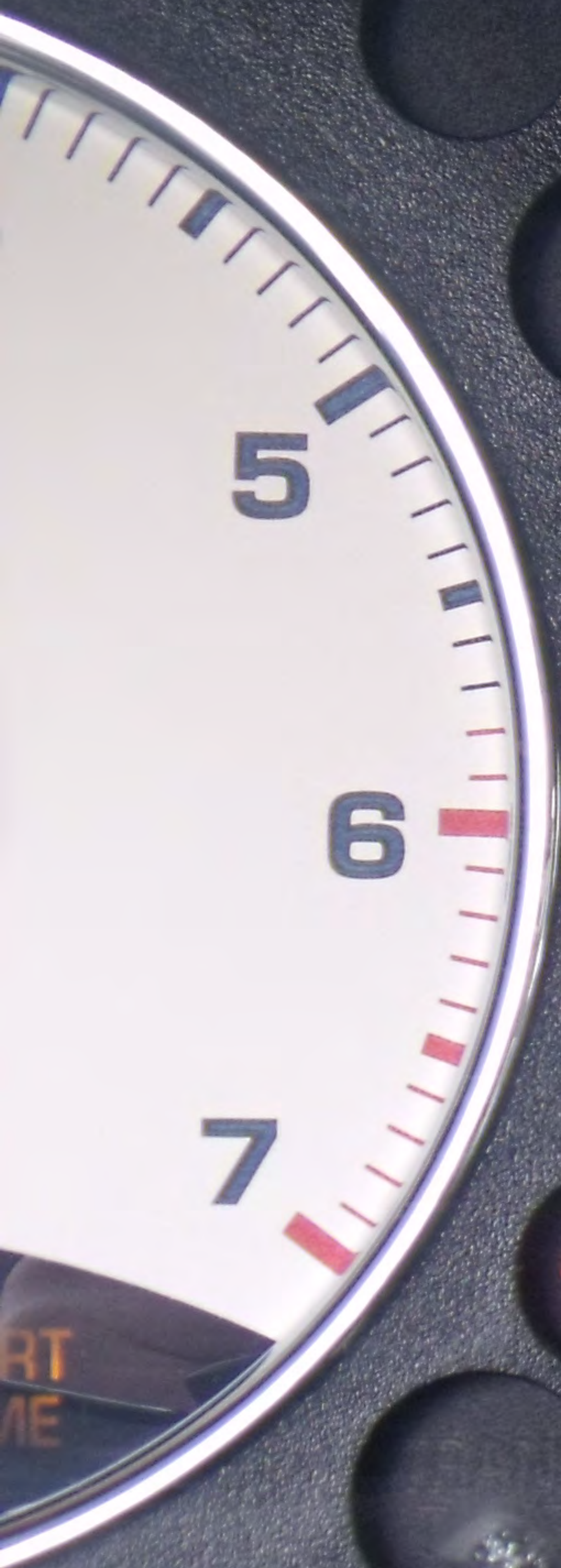



AIR  
BAG







THANK YOU!  
BEEN A PLEASURE  
SERVE YOU

**Initial Case Questions**

Date of call to owner \_\_\_\_\_  
Owners Name \_\_\_\_\_  
Was there a Recall on vehicle \_\_\_\_\_  
Was recall completed \_\_\_\_\_

2014  
4400-110-01  
01/20/14  
01/20/14











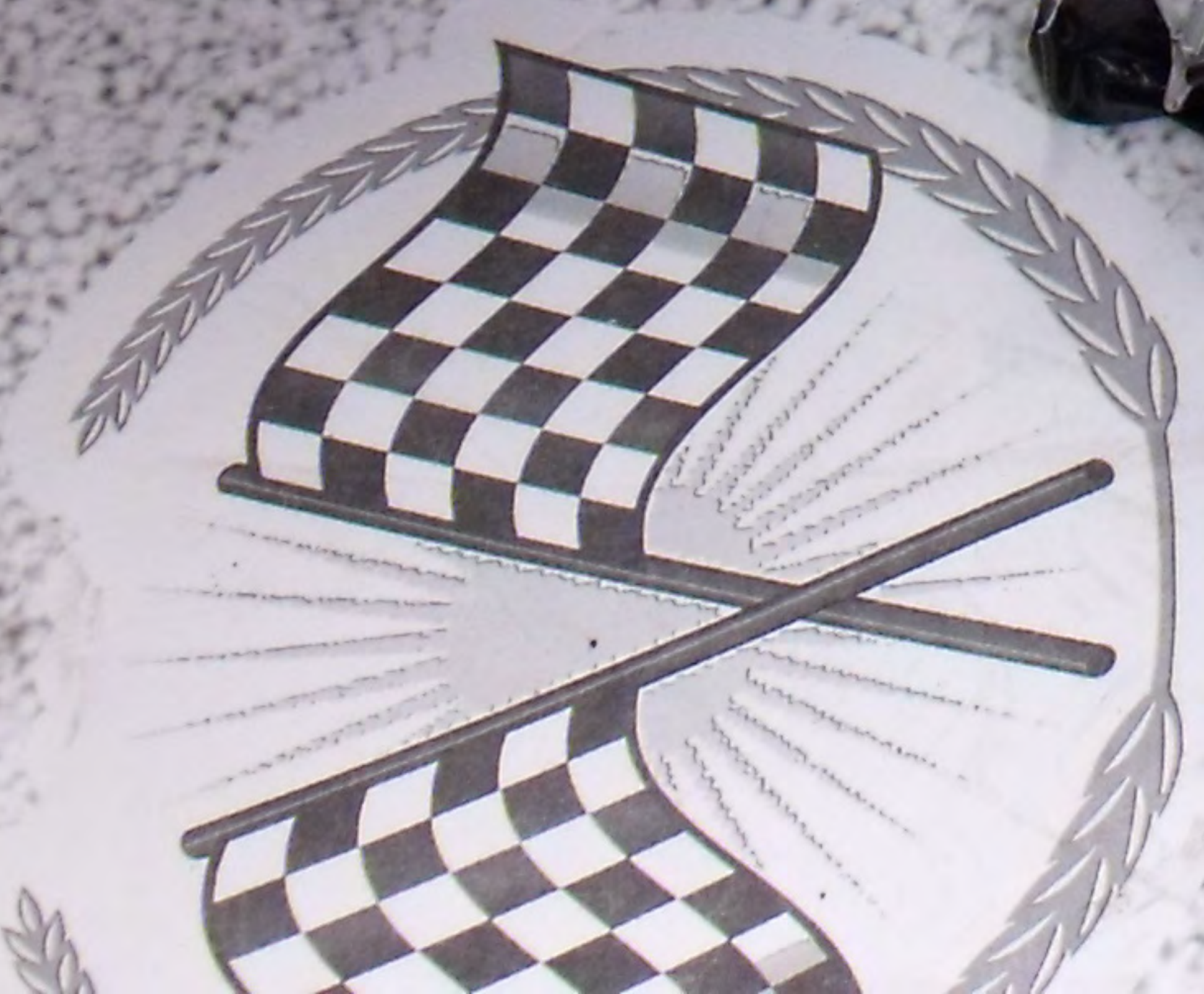

SERVE YOU  
  
 Your Patronage is  
 Appreciated - Very Much!  
 We have tried our best to keep your carpeting  
 with this durable protective mat. Please drive  
 USA  
 Detailing  
 acts



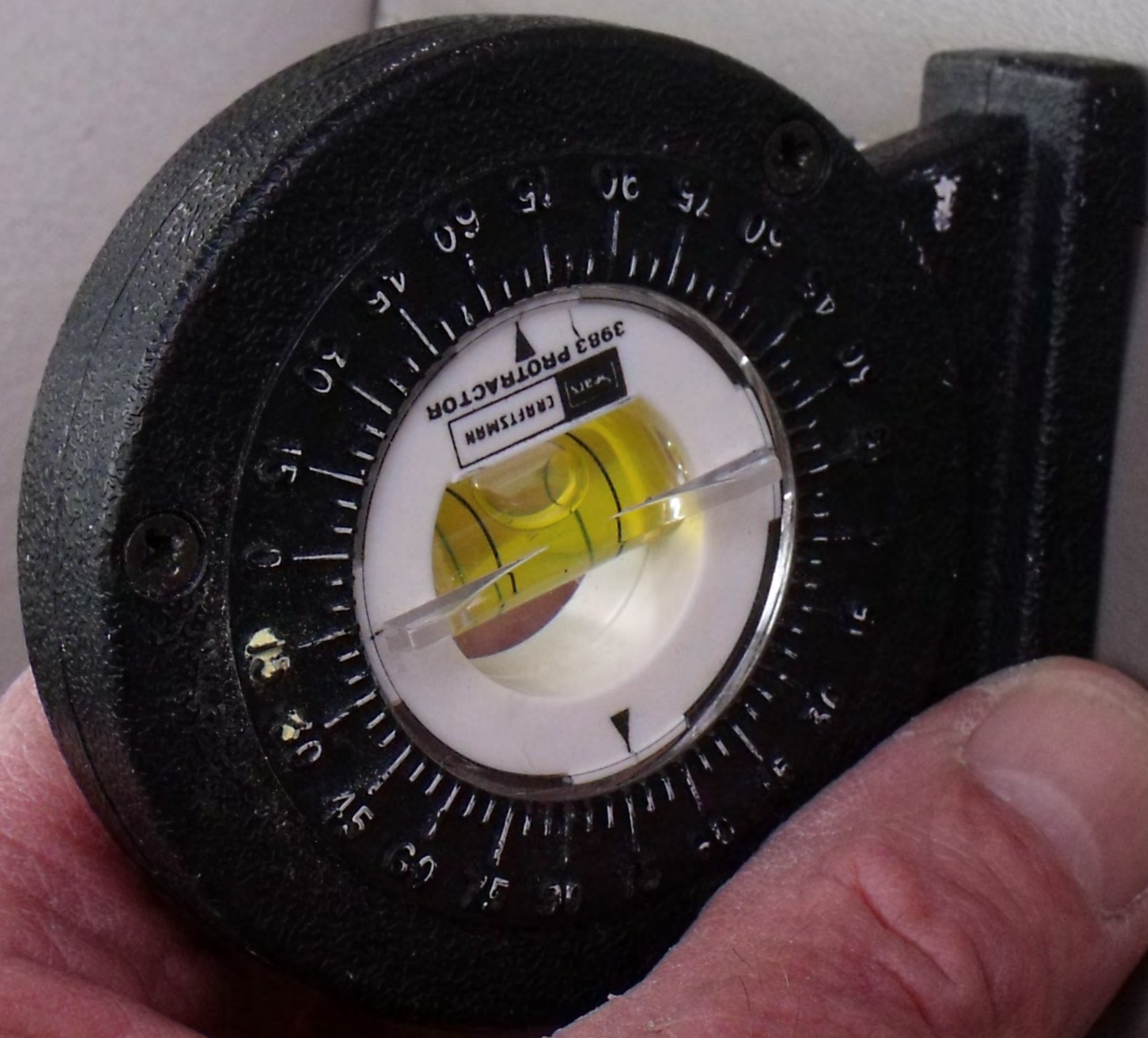













1584









PRESS



















**⚠ WARNING**  
**DEATH OR SERIOUS INJURY CAN OCCUR**

- CHILDREN 12 AND UNDER CAN BE KILLED BY THE AIR BAG.
- THE BACK SEAT IS THE SAFEST PLACE FOR CHILDREN.
- NEVER PUT A REAR-FACING CHILD SEAT IN THE FRONT.
- SIT AS FAR BACK AS POSSIBLE FROM THE AIR BAG.
- ALWAYS USE SEAT BELTS AND CHILD RESTRAINTS.

**⚠ WARNING: NEVER BELT IN**



READ CAREFULLY INSTRUCTIONS AND OCCUPANT GUIDE.

ALWAYS BELT UP.



SEE OWNER'S MANUAL FOR FURTHER INFORMATION.











18A

P  
R  
N  
D  
2  
1

WARNING

ep

















MERCEDES-BENZ  
HALEY SCULLIN  
NORTH COLONY

PUSH  
56010321A5  
PUSH









HAL  
NG

5  
HI













164  
Key Tag

PUSH ON/VOL  
SEEK  
BASS TREB  
AM FM  
TAP  
MODE  
DISC  
L1 | L2 | L3 | L4 | L5 | L6 | L7 | L8 | L9 | L10 | L11 | L12 | L13 | L14 | L15 | L16 | L17 | L18 | L19 | L20 | L21 | L22 | L23 | L24 | L25 | L26 | L27 | L28 | L29 | L30 | L31 | L32 | L33 | L34 | L35 | L36 | L37 | L38 | L39 | L40 | L41 | L42 | L43 | L44 | L45 | L46 | L47 | L48 | L49 | L50 | L51 | L52 | L53 | L54 | L55 | L56 | L57 | L58 | L59 | L60 | L61 | L62 | L63 | L64 | L65 | L66 | L67 | L68 | L69 | L70 | L71 | L72 | L73 | L74 | L75 | L76 | L77 | L78 | L79 | L80 | L81 | L82 | L83 | L84 | L85 | L86 | L87 | L88 | L89 | L90 | L91 | L92 | L93 | L94 | L95 | L96 | L97 | L98 | L99 | L100 | L101 | L102 | L103 | L104 | L105 | L106 | L107 | L108 | L109 | L110 | L111 | L112 | L113 | L114 | L115 | L116 | L117 | L118 | L119 | L120 | L121 | L122 | L123 | L124 | L125 | L126 | L127 | L128 | L129 | L130 | L131 | L132 | L133 | L134 | L135 | L136 | L137 | L138 | L139 | L140 | L141 | L142 | L143 | L144 | L145 | L146 | L147 | L148 | L149 | L150 | L151 | L152 | L153 | L154 | L155 | L156 | L157 | L158 | L159 | L160 | L161 | L162 | L163 | L164 | L165 | L166 | L167 | L168 | L169 | L170 | L171 | L172 | L173 | L174 | L175 | L176 | L177 | L178 | L179 | L180 | L181 | L182 | L183 | L184 | L185 | L186 | L187 | L188 | L189 | L190 | L191 | L192 | L193 | L194 | L195 | L196 | L197 | L198 | L199 | L200 | L201 | L202 | L203 | L204 | L205 | L206 | L207 | L208 | L209 | L210 | L211 | L212 | L213 | L214 | L215 | L216 | L217 | L218 | L219 | L220 | L221 | L222 | L223 | L224 | L225 | L226 | L227 | L228 | L229 | L230 | L231 | L232 | L233 | L234 | L235 | L236 | L237 | L238 | L239 | L240 | L241 | L242 | L243 | L244 | L245 | L246 | L247 | L248 | L249 | L250 | L251 | L252 | L253 | L254 | L255 | L256 | L257 | L258 | L259 | L260 | L261 | L262 | L263 | L264 | L265 | L266 | L267 | L268 | L269 | L270 | L271 | L272 | L273 | L274 | L275 | L276 | L277 | L278 | L279 | L280 | L281 | L282 | L283 | L284 | L285 | L286 | L287 | L288 | L289 | L290 | L291 | L292 | L293 | L294 | L295 | L296 | L297 | L298 | L299 | L300 | L301 | L302 | L303 | L304 | L305 | L306 | L307 | L308 | L309 | L310 | L311 | L312 | L313 | L314 | L315 | L316 | L317 | L318 | L319 | L320 | L321 | L322 | L323 | L324 | L325 | L326 | L327 | L328 | L329 | L330 | L331 | L332 | L333 | L334 | L335 | L336 | L337 | L338 | L339 | L340 | L341 | L342 | L343 | L344 | L345 | L346 | L347 | L348 | L349 | L350 | L351 | L352 | L353 | L354 | L355 | L356 | L357 | L358 | L359 | L360 | L361 | L362 | L363 | L364 | L365 | L366 | L367 | L368 | L369 | L370 | L371 | L372 | L373 | L374 | L375 | L376 | L377 | L378 | L379 | L380 | L381 | L382 | L383 | L384 | L385 | L386 | L387 | L388 | L389 | L390 | L391 | L392 | L393 | L394 | L395 | L396 | L397 | L398 | L399 | L400 | L401 | L402 | L403 | L404 | L405 | L406 | L407 | L408 | L409 | L410 | L411 | L412 | L413 | L414 | L415 | L416 | L417 | L418 | L419 | L420 | L421 | L422 | L423 | L424 | L425 | L426 | L427 | L428 | L429 | L430 | L431 | L432 | L433 | L434 | L435 | L436 | L437 | L438 | L439 | L440 | L441 | L442 | L443 | L444 | L445 | L446 | L447 | L448 | L449 | L450 | L451 | L452 | L453 | L454 | L455 | L456 | L457 | L458 | L459 | L460 | L461 | L462 | L463 | L464 | L465 | L466 | L467 | L468 | L469 | L470 | L471 | L472 | L473 | L474 | L475 | L476 | L477 | L478 | L479 | L480 | L481 | L482 | L483 | L484 | L485 | L486 | L487 | L488 | L489 | L490 | L491 | L492 | L493 | L494 | L495 | L496 | L497 | L498 | L499 | L500 | L501 | L502 | L503 | L504 | L505 | L506 | L507 | L508 | L509 | L510 | L511 | L512 | L513 | L514 | L515 | L516 | L517 | L518 | L519 | L520 | L521 | L522 | L523 | L524 | L525 | L526 | L527 | L528 | L529 | L530 | L531 | L532 | L533 | L534 | L535 | L536 | L537 | L538 | L539 | L540 | L541 | L542 | L543 | L544 | L545 | L546 | L547 | L548 | L549 | L550 | L551 | L552 | L553 | L554 | L555 | L556 | L557 | L558 | L559 | L560 | L561 | L562 | L563 | L564 | L565 | L566 | L567 | L568 | L569 | L570 | L571 | L572 | L573 | L574 | L575 | L576 | L577 | L578 | L579 | L580 | L581 | L582 | L583 | L584 | L585 | L586 | L587 | L588 | L589 | L590 | L591 | L592 | L593 | L594 | L595 | L596 | L597 | L598 | L599 | L600 | L601 | L602 | L603 | L604 | L605 | L606 | L607 | L608 | L609 | L610 | L611 | L612 | L613 | L614 | L615 | L616 | L617 | L618 | L619 | L620 | L621 | L622 | L623 | L624 | L625 | L626 | L627 | L628 | L629 | L630 | L631 | L632 | L633 | L634 | L635 | L636 | L637 | L638 | L639 | L640 | L641 | L642 | L643 | L644 | L645 | L646 | L647 | L648 | L649 | L650 | L651 | L652 | L653 | L654 | L655 | L656 | L657 | L658 | L659 | L660 | L661 | L662 | L663 | L664 | L665 | L666 | L667 | L668 | L669 | L670 | L671 | L672 | L673 | L674 | L675 | L676 | L677 | L678 | L679 | L680 | L681 | L682 | L683 | L684 | L685 | L686 | L687 | L688 | L689 | L690 | L691 | L692 | L693 | L694 | L695 | L696 | L697 | L698 | L699 | L700 | L701 | L702 | L703 | L704 | L705 | L706 | L707 | L708 | L709 | L710 | L711 | L712 | L713 | L714 | L715 | L716 | L717 | L718 | L719 | L720 | L721 | L722 | L723 | L724 | L725 | L726 | L727 | L728 | L729 | L730 | L731 | L732 | L733 | L734 | L735 | L736 | L737 | L738 | L739 | L740 | L741 | L742 | L743 | L744 | L745 | L746 | L747 | L748 | L749 | L750 | L751 | L752 | L753 | L754 | L755 | L756 | L757 | L758 | L759 | L760 | L761 | L762 | L763 | L764 | L765 | L766 | L767 | L768 | L769 | L770 | L771 | L772 | L773 | L774 | L775 | L776 | L777 | L778 | L779 | L780 | L781 | L782 | L783 | L784 | L785 | L786 | L787 | L788 | L789 | L790 | L791 | L792 | L793 | L794 | L795 | L796 | L797 | L798 | L799 | L800 | L801 | L802 | L803 | L804 | L805 | L806 | L807 | L808 | L809 | L810 | L811 | L812 | L813 | L814 | L815 | L816 | L817 | L818 | L819 | L820 | L821 | L822 | L823 | L824 | L825 | L826 | L827 | L828 | L829 | L830 | L831 | L832 | L833 | L834 | L835 | L836 | L837 | L838 | L839 | L840 | L841 | L842 | L843 | L844 | L845 | L846 | L847 | L848 | L849 | L850 | L851 | L852 | L853 | L854 | L855 | L856 | L857 | L858 | L859 | L860 | L861 | L862 | L863 | L864 | L865 | L866 | L867 | L868 | L869 | L870 | L871 | L872 | L873 | L874 | L875 | L876 | L877 | L878 | L879 | L880 | L881 | L882 | L883 | L884 | L885 | L886 | L887 | L888 | L889 | L890 | L891 | L892 | L893 | L894 | L895 | L896 | L897 | L898 | L899 | L900 | L901 | L902 | L903 | L904 | L905 | L906 | L907 | L908 | L909 | L910 | L911 | L912 | L913 | L914 | L915 | L916 | L917 | L918 | L919 | L920 | L921 | L922 | L923 | L924 | L925 | L926 | L927 | L928 | L929 | L930 | L931 | L932 | L933 | L934 | L935 | L936 | L937 | L938 | L939 | L940 | L941 | L942 | L943 | L944 | L945 | L946 | L947 | L948 | L949 | L950 | L951 | L952 | L953 | L954 | L955 | L956 | L957 | L958 | L959 | L960 | L961 | L962 | L963 | L964 | L965 | L966 | L967 | L968 | L969 | L970 | L971 | L972 | L973 | L974 | L975 | L976 | L977 | L978 | L979 | L980 | L981 | L982 | L983 | L984 | L985 | L986 | L987 | L988 | L989 | L990 | L991 | L992 | L993 | L994 | L995 | L996 | L997 | L998 | L999 | L1000

















Jeep

POWERTECH  
2.4L

ENGINE OIL  
FOR CLASS ENGINE  
SEE OWNERS MANUAL

CAUTION  
COOLING SYSTEM

13/32 IN - GY 4860 - 42392 - AC - 13/32 IN

ATTENTION





POWER TECH  
3.7L V6

56041693AA  
TNT21000-4440  
DENSO

CAUTION FAN

ENGINE OIL  
FOR GASOLINE  
ENGINES  
SEE OWNERS MANUAL

CAUTION





**⚠ DANGER / POISON**

SHIELD EYES FROM SPARKS  
NO SMOKE OR FLAMES  
CAN CAUSE BURNING OR INJURY ON CONTACT

MEGA-TRON II  
55

DO NOT GET ON THE FACE OF SPARKS  
FLUSH EYES IMMEDIATELY  
WITH WATER FOR 15 MIN  
SEEK MEDICAL HELP IF NECESSARY  
POLYMER BATTERY CASE IS NOT TO BE REPAIRED  
BEST SERVICE PERFORMANCE

GLOBE ALPHA

RELEASE LATCH  
FOR ACCESS TO  
FUSES AND RELAYS

56009951AJ  
56009951AJ  
56009951AJ

2 3 094









RELEASE LATCH FOR ACCESS TO FUSES AND RELAYS

1-800-853-8338  
P1 8400951A3  
17 8400951A3000

Jeep

BELT ROUTING



5300 950

CATALYST

2 3 094



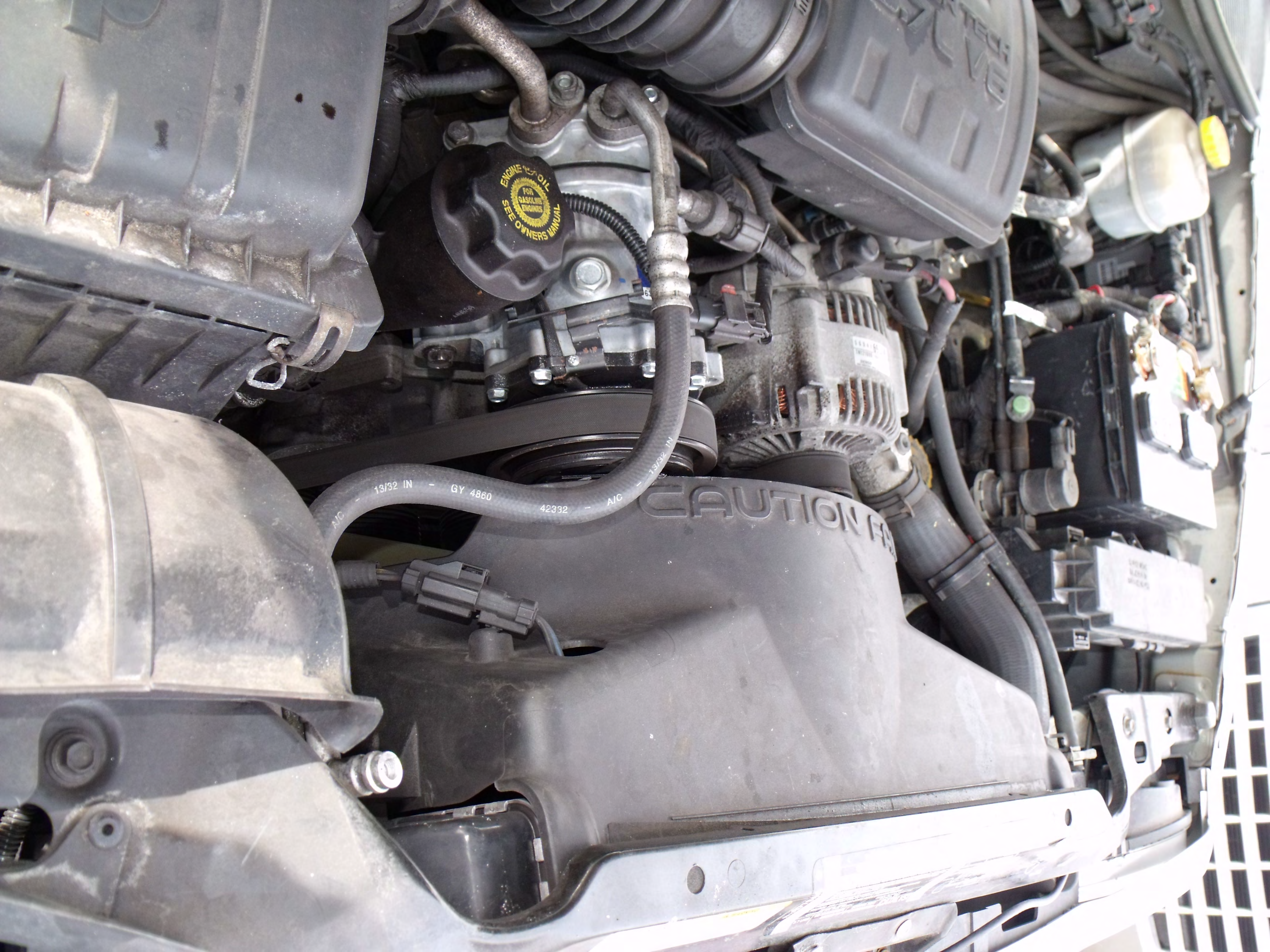

ENGINE OIL  
FOR GASOLINE ENGINES  
SEE OWNERS MANUAL

1 3/32 IN - GY 4860

42332 - A/C

CAUTION

E-TECH  
VTEC

WATER PUMP  
REPLACE



# **⚠ WARNING**

## **DEATH OR SERIOUS INJURY CAN OCCUR**



- CHILDREN 12 AND UNDER CAN BE KILLED BY THE AIR BAG.
- THE BACK SEAT IS THE SAFEST PLACE FOR CHILDREN.
- NEVER PUT A REAR-FACING CHILD SEAT IN THE FRONT.
- SIT AS FAR BACK AS POSSIBLE FROM THE AIR BAG.
- ALWAYS USE SEAT BELTS AND CHILD RESTRAINTS.















P R N D 2 1

2WD  
4WD  
4WD Lock

POWER  
OUTLET





PLEASE DO NOT  
REMOVE THIS  
LABEL FROM THE  
SEAT

PRESS

























**Radio and Climate Control Panel**

**Radio Section:**

- Left: Volume knob (PUSH ON/VOL), SEEK buttons (up/down), RBP (Repeat) button.
- Center: Digital display showing **3:36**, COMPACT disc DIGITAL AUDIO indicator, H (Hold) and M (Memory) buttons, EJT CD (Eject Compact Disc) button.
- Right: FF (Fast Forward) TUNE, RW (Reverse Wind) buttons.

**Radio Presets and Features:**

- Left: BAL (Balance) and FADE (Fader) knobs (R/F), BASS and TREB (Trebble) sliders.
- Center: AM FM, TAPE, MODE, DOLBY B NR, AUTO METAL, RDS (Radio Data System) indicator.
- Right: EJT TAPE (Eject Tape), PTY (Program Type) button, SCAN, SET buttons.

**Radio Presets:** DISC 1, 2, 3, 4, 5, RND (Random), TIME.

**Climate Control Section:**

- Left: Fan speed knob (1-4), fan icon.
- Center: Temperature knob, gear icons for fan speed.
- Right: Temperature knob with blue (cool) and red (warm) indicators.

ANK YOU  
EEN A PL



SEE OWNER'S MANUAL FOR DETAILS

HIGH  
BEAM

DAYTIME  
RUNNING  
LIGHTS

1

16

26

2

17

27

3

18

28

4

19

29

5

20

30

6

21

31

7

22

32

8

23

33

9

34

10

35

11

36

12

37

13

14

24

38

15

25

39















Unable to ID Module for  
ORC

press any key to continue



NO RESPONSE from SRM  
Please make certain of the  
following items:

- 1) Ignition is turned on.
- 2) DRB III is properly  
connected to the Data  
connector.

F1  
HELP

F2

F3

64.1

F1

F2

F3

F4







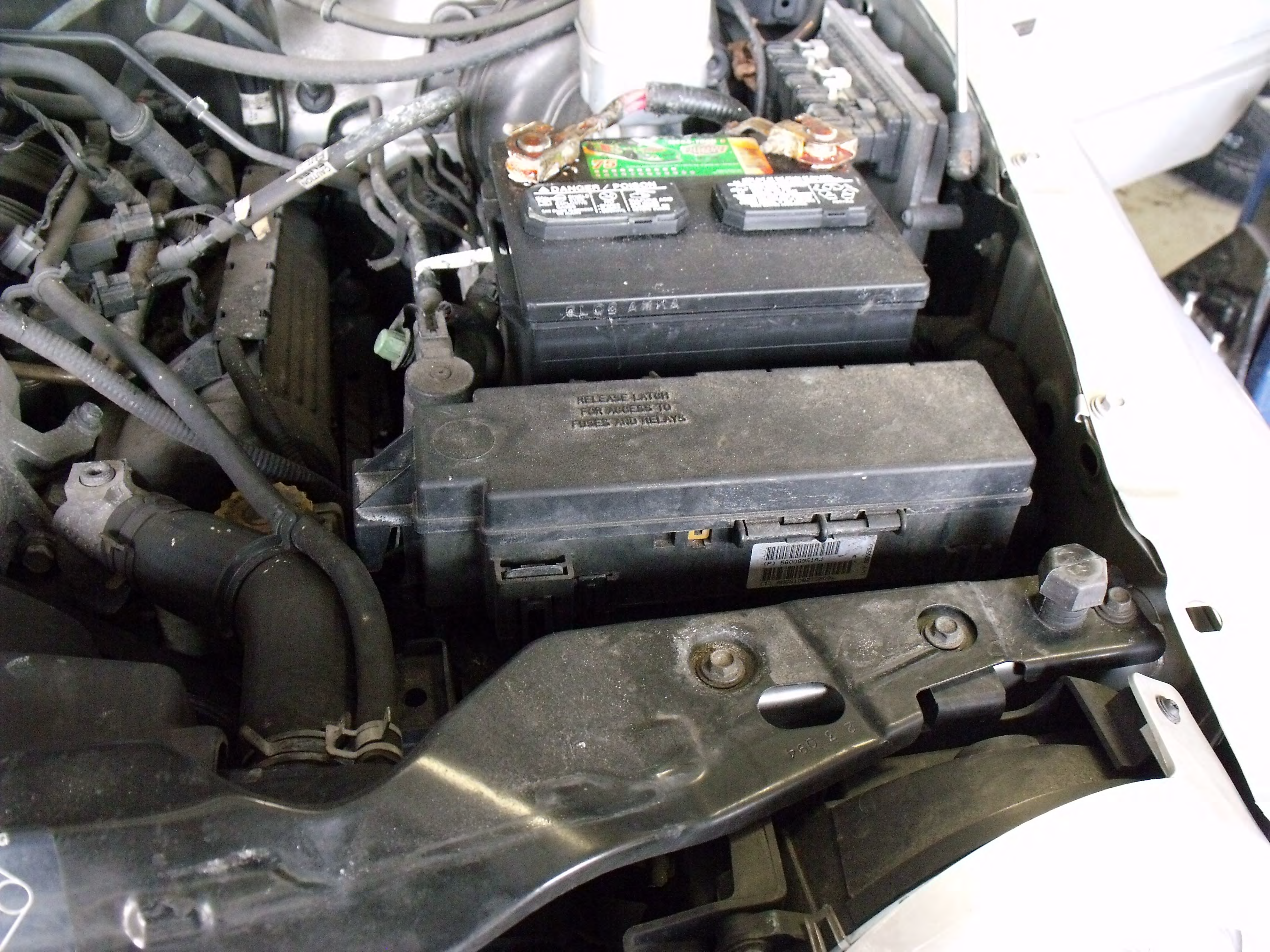

DANGER / POISON  
DO NOT TOUCH  
DO NOT OPEN  
DO NOT REMOVE  
DO NOT DISCONNECT

GL 08 A M M A

RELEASE LATCH  
FOR ACCESS TO  
FUSES AND RELAYS

(P) 56008951AJ  
CT 1 4331082 800

2 7 094



CLORANNA

40	40	50	15	4671168E	04848879AA	4671168E
40	40	50	DE	4671168E	VF4-15F21-Z05	4671168E
40	30	30	30	72472M	04848879AA	72472M
40	30	30	30	4671168E	VF4-15F21-Z05	72472M
40	50	30	30	4671168E	04848879AA	4671168E
50	40	40	30	72472M	72472M	72472M

FUEL PUMP

BLOWER MOTOR

ARC CLUTCH





**⚠ DANGER / POISON**  
SHIELD EYES  
EXPLOSIVE  
GASES  
CAN CAUSE BURNING  
OR BLINDNESS  
ON HEAVY

DO NOT GET ON THE FACE OF CAR BATTERY  
ALWAYS WEAR PROTECTIVE  
EYEWEAR AND GLOVES  
NEVER POUR ON HOT  
SURFACES  
NEVER POUR ON  
FLAMMABLE LIQUIDS  
NEVER POUR ON  
OILS  
NEVER POUR ON  
HOT SURFACES  
NEVER POUR ON  
HOT SURFACES  
NEVER POUR ON  
HOT SURFACES

**MEGA-TRON II**  
75

GLOB ANNA

2A/20A  
5A/15A  
10A/10A  
15A/10A  
20A/10A  
25A/10A  
30A/10A  
35A/10A  
40A/10A  
45A/10A  
50A/10A  
55A/10A  
60A/10A  
65A/10A  
70A/10A  
75A/10A  
80A/10A  
85A/10A  
90A/10A  
95A/10A  
100A/10A



ENGINE OIL  
FOR  
GASOLINE  
ENGINES  
SEE OWNERS MANUAL

56041693AA  
TN121000-4440 12V  
DENSO  
DENSO MANUFACTURING, TENNESSEE, U.S.A. 70113

42332  
19132 IN

CAUTION



ENGINE OIL  
FOR GASOLINE  
ENGINES  
CERTIFIED  
OWNERS MANUAL

COMI

5604  
TN12100  
DENSO  
DENSO MANUFACTURING

13/32 IN

CAUTION





52128779AA



### DaimlerChrysler Corporation IMPORTANT VEHICLE INFORMATION

THIS VEHICLE CONFORMS TO U.S. EPA NLEV REGULATIONS APPLICABLE TO 2002 MODEL YEAR NEW LEV LIGHT DUTY TRUCKS AND CALIFORNIA REGULATIONS APPLICABLE TO 2002 MODEL YEAR NEW LEV LIGHT-DUTY TRUCKS. SFTP COMPLIANT.

\*BASIC IGNITION TIMING AND THE FACTORY. SEE THE OTHER ADDITIONAL INFORMATION. ADJUSTMENTS MADE BY OTHER PROCEDURES MAY VIOLATE CAUTION: APPLY

3.7 LITER  
NO ADJUSTMENTS NEEDED

2CRXRO155GCH

CATALYST

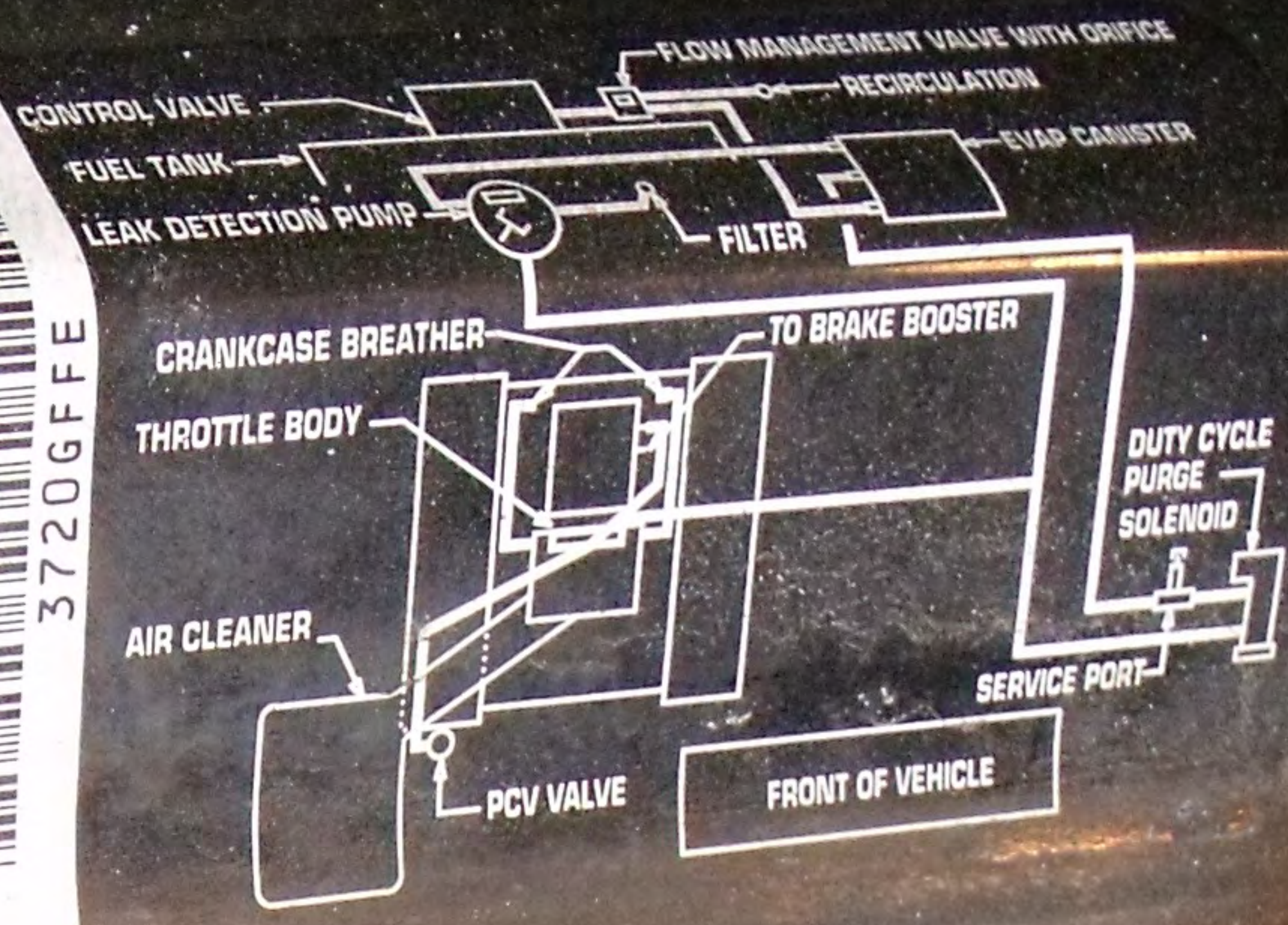



52128779AA

DaimlerChrysler Corporation

**IMPORTANT VEHICLE INFORMATION**

THIS VEHICLE CONFORMS TO U.S. EPA NLEV REGULATIONS APPLICABLE TO 2002 MODEL YEAR NEW LEV LIGHT DUTY TRUCKS AND CALIFORNIA REGULATIONS APPLICABLE TO 2002 MODEL YEAR NEW LEV LIGHT-DUTY TRUCKS. SFTP COMPLIANT.

\*BASIC IGNITION THE F... OTHER...  
...ANTS ...ES M...  
...APPLY

...HO2S(2), OBDII  
...CERTIFIED, SFI, TWC 2AWHC  
...2CRXR0155GCH

3.7 LITER NO ADJUSTMENTS NEEDED

CATALYST

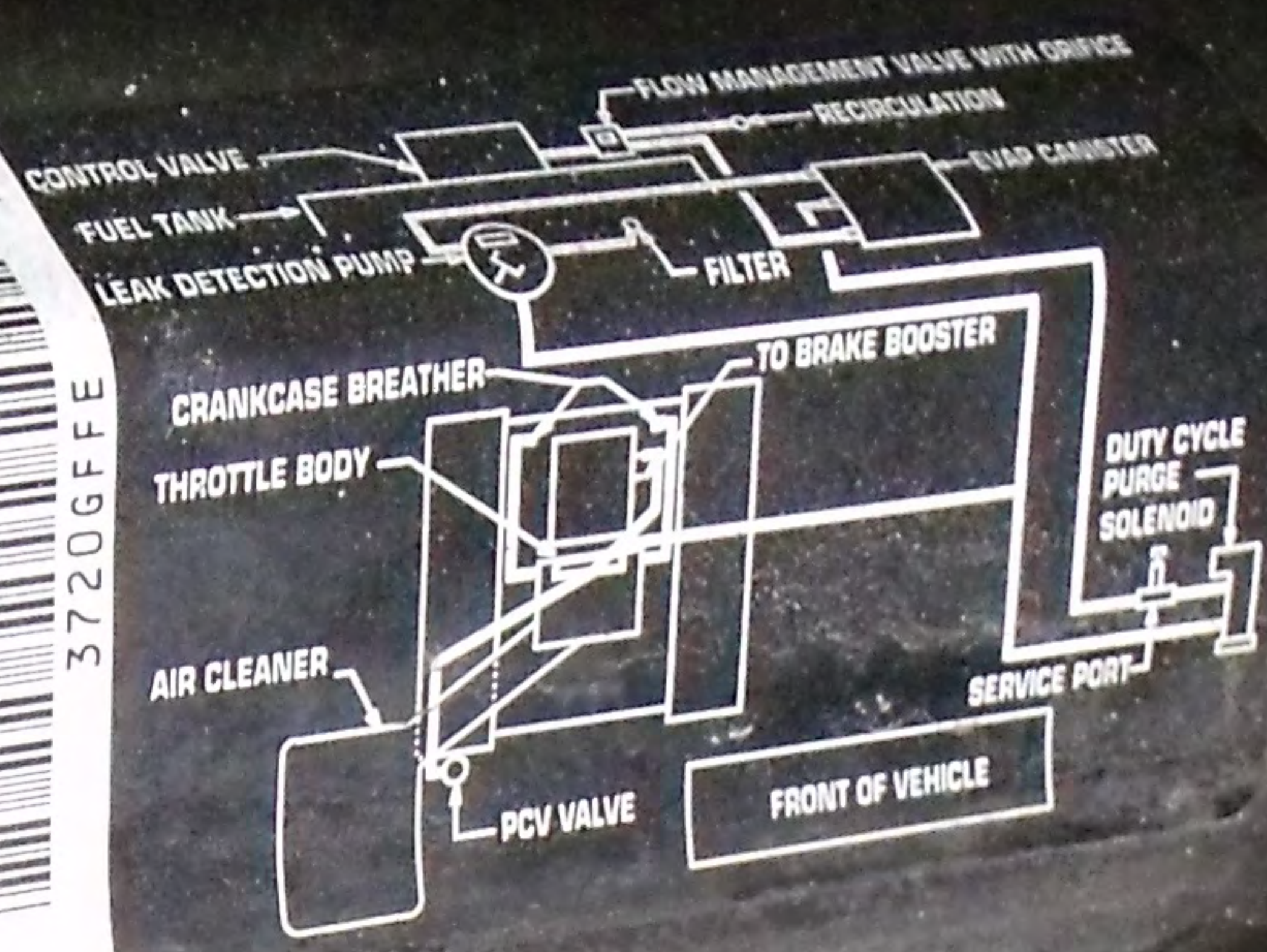





LIBERTY LIMITED EDITION

STAMPED

SW







SAE F98 24-00





PS2-117-9

PS2-117-9  
TBC-0224-00

GOODYEAR  
STAMPED















TRACTION  
TREADWEAR 550

6856  
10S1092L0605  
P5211178AB

Handwritten white mark on the tire tread.





100001

BIEN

ASSURANCE

GOODYEAR

MS













A man in a white shirt and tie standing in the background of the workshop.

A red jack stand used for supporting the vehicle.

A large industrial fan in the background.

A stack of tires in the background.

Cardboard boxes stacked in the background.

Another person in a white shirt and dark pants in the background.





SIGMA

L2

L2

R

5





RR

RR

RR

SIGMA

EXIT

EXIT





RR

RR



RADIAL SUN

STAMPED

RF





STAMPED

RADIAL SUV

Jeep

TREEDWEAR (640) TRACTION (A) TEMPERATURE (E)







RADIAL

AIS

GOODYEAR

P235/70R16 M+S

Jeep

TM





STAMPEDE



RADIAL

RR  
AS























**EDJOMKO**  
CHRYSLER GROUP LLC  
AVON LAKE, OHIO

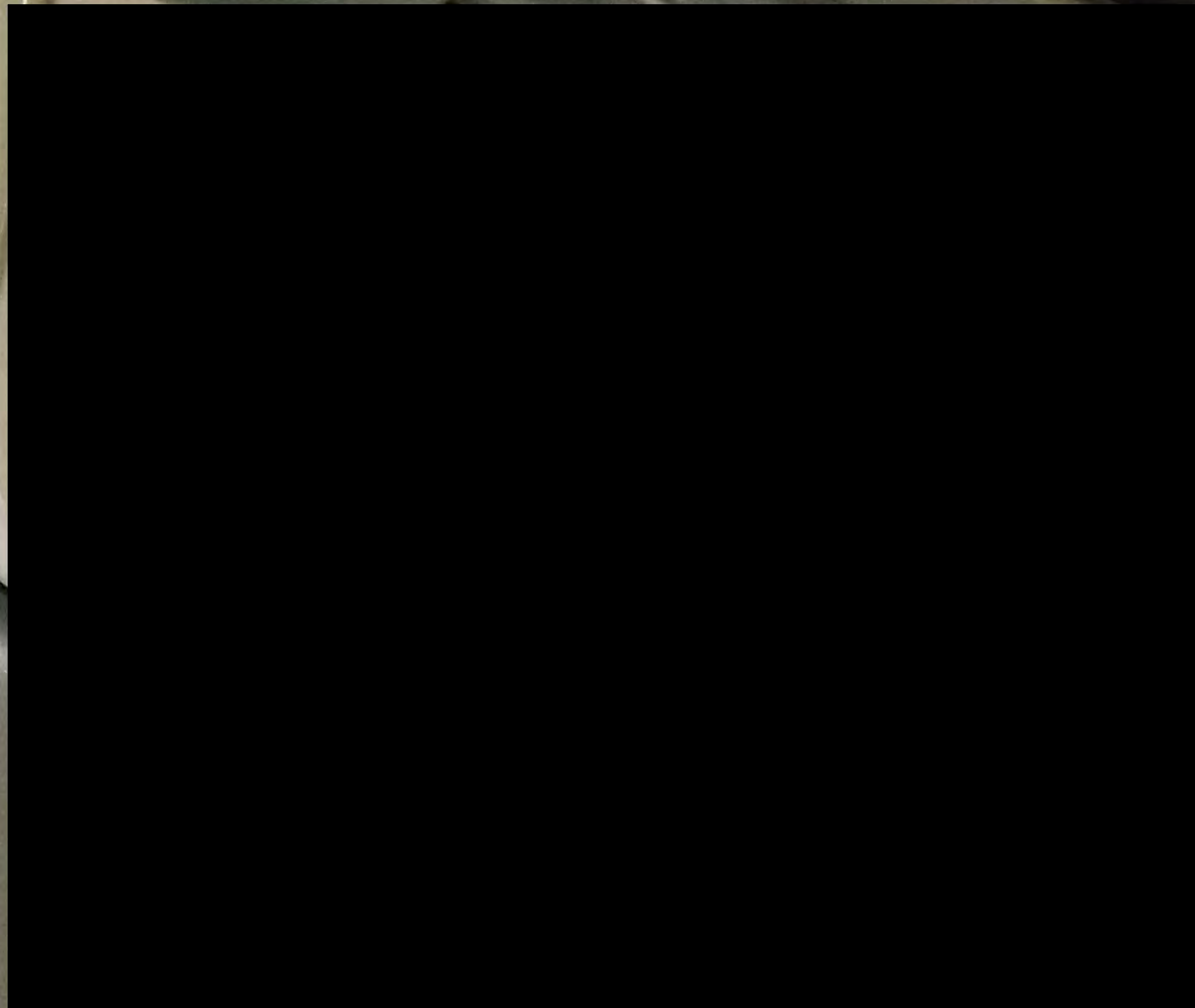



Occupant Classification Module

Body Style:

S/W Version: 0.0



EA12-001

CHRYSLER

10-4-2012

ENCLOSURE 4

FIELD DATA SUBJECT

CAIRs Backup



MFD BY DAIMLERCHRYSLER CORPORATION DATE OF MFR 5-02 GVWR 2427 KG(05350 LB)

GVWR FRONT	WITH TIRES	RIMS AT	COLD
1248 KG(2750 LB)	P215/75SR16	16X7	227 KPA(33 PSI)
GVWR REAR	WITH TIRES	RIMS AT	COLD
1339 KG(2950 LB)	P215/75SR16	16X7	227 KPA(33 PSI)

THIS VEHICLE CONFORMS TO ALL APPLICABLE FEDERAL MOTOR VEHICLE SAFETY AND THEFT PREVENTION STANDARDS IN EFFECT ON THE DATE OF MANUFACTURE SHOWN ABOVE.

VIN: 1J4GK4BK32L [REDACTED] TYPE: MPV SINGLE X DUAL



NOI: 051020 779AA PNT:PW1 VEHICLE MADE IN U.S.A. TRN:MSLS -0040503





54935









LIBERTY 4x4





LIBERTY sport









Jeep

Jeep





Jeep

Jeep

87L

































Jeep

























Lock Release ← → Lock Engage







**CAUTION**

Do not use the  
lowering jack  
to lift the  
vehicle.

**CAUTION**

Do not use the  
lowering jack  
to lift the  
vehicle.









HUNTER

HSP400

8

8

Lock

Lock











A close-up photograph of a person's hand, wearing a grey suit jacket and a white shirt cuff, touching a grey plastic bumper of a white vehicle. The vehicle's red taillight is visible on the left. On the white body panel above the bumper, the word "Jeep" is printed in a bold, black, sans-serif font. Below "Jeep", there is smaller, less legible text, possibly "4x4" and "1000000000". A large black rectangular redaction box covers the lower right portion of the image, obscuring the person's face and the lower part of the bumper.

**Jeep**  
4x4  
1000000000















Lock  
Engage

Warning

Lower

↑  
Raise





































RR





REF













NEW YORK  
G35838











































**WARNING**

**DEATH OR SERIOUS  
INJURY CAN OCCUR**



NEVER ALLOW SEAT BACK TO LEAN REARWARD.  
THE SEAT BACK IS THE SAFEST PLACE FOR PASSENGERS.  
REARWARD LEANING MAY OCCUR DUE TO THE FORCE  
OF A COLLISION. EXCESSIVE REARWARD LEANING  
MAY BE THE CAUSE OF SERIOUS INJURY.

**WARNING: HIGHER ROLLOVER RISK**



AVOID ABRUPT MANEUVERS  
AND EXCESSIVE SPEED.

ALWAYS BUCKLE UP.

SEE OWNER'S MANUAL  
FOR FURTHER INFORMATION.























♿  
015807

Jeep











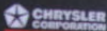

CHRYSLER  
CORPORATION

DRB III™

This Diagnostic Control  
Module is not supported by  
this software. Please use the  
DRB III with the Supercard  
software to diagnose this  
vehicle.

KEEP

SYS

MAIN





CHRYSLER  
CORPORATION

DRB III™

Unable to ID Module for  
ORC

press any key to continue









BRAKE

OIL

door



EA12-001

CHRYSLER

10-4-2012

ENCLOSURE 4

FIELD DATA SUBJECT

CAIRs Backup





Jeep  
*Deluxe*

3.7L

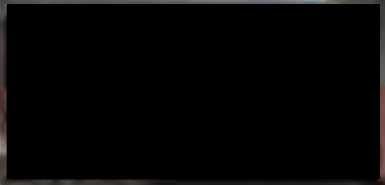









3654

Jeep

















Jeep





























MFD BY DAIMLERCHRYSLER CORPORATION

DATE OF MFR  
2-02

GWR  
2427 KG(05350 LB)

GWR FRONT WITH TIRES  
1248 KG(2750 LB) 235/70R16

RIMS AT COLD  
16X7 227 KPA(33 PSI)

GWR REAR WITH TIRES  
1339 KG(2950 LB) 235/70R16

RIMS AT COLD  
16X7 227 KPA(33 PSI)

THIS VEHICLE CONFORMS TO ALL APPLICABLE FEDERAL MOTOR VEHICLE SAFETY AND THEFT PREVENTION STANDARDS IN EFFECT ON THE DATE OF MANUFACTURE SHOWN ABOVE.

VIN: 1J4GK58K72W [REDACTED] TYPE: MPV SINGLE X DUAL



MDK: 020500 387AA PNT:PRV VEHICLE MADE IN U.S.A. TRM:DL2 4048503



MPH km/h

120

TYPE 35

097872

TRIP













ON - OFF

CRUISE

SET

Jeep









PRESS







042021R

MEETS FMVSS 200  
ASSEMBLED IN MEXICO

101-07



DAIMLER



P5HG331L8AF



**TRW**

H01-06

034023R

MEETS FMVSS 209  
ASSEMBLED IN MEXICO







PRESS



It's a day  
I'm  
I'm  
I'm

Jeep t









2



DNR







**TRW**

H01-08

042021N

MEETS FMVSS 209  
ASSEMBLED IN MEXICO











**TRW**

H01-10

034021N

MEETS FMVSS 209  
ASSEMBLED IN MEXICO











**AIR  
BAG**



**7**













4 8 12 16 20 24 28  
8 16 24 32 40 48 56

**1**

4 8 12 16 20 24 28  
8 16 24 32 40 48 56

NO. 300

**2**

4 8 12 16 20 24 28  
8 16 24 32 40 48 56

**3**

4 8







DAIMLER CHRYSLER



P5HG341L8AE





DAIMLER CHRYSLER



P5HG361L8AF



TR5022236740



DAIMLER CHRYSLER

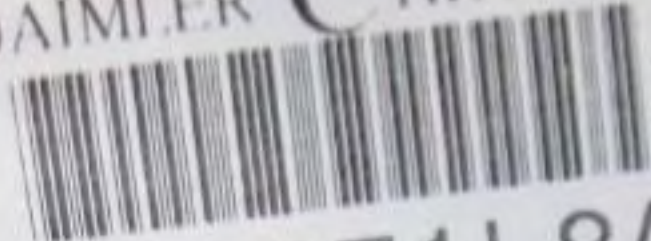

P5HG371L8AF



TR4017228796



312950

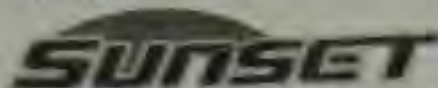

DODGE • CHRYSLER • JEEP • RAM

141 SOUTH TAMM LANE • SARASOTA, FLORIDA 34231  
STATE OF FLORIDA REGISTRATION MV-60017 • (800) 451-1000  
www.sunsetautorepair.com

MEMBER OF THE "OF OUR MINDS"  
O.C.

By \_\_\_\_\_

STATE REG. MV-60271

WE SHOPTS AND OUR OWNERS STRONGLY URGES:

WE WANT OUR CUSTOMER CUSTOMER  
SATISFACTION SCORES HERE

THE HIGHEST SERVICES

DATE	REPAIR ORDER	INVOICE	ADVISOR	TECHNICIAN	WVE

SERVICE

1J4GK58K72W [REDACTED] 02/JEEP/LIBERTY/2ND LIMITED  
 SARASOTA, FL [REDACTED] 03/02/03  
 GARNET RED/  
 N CH22 Y Y 37,673 KM  
 09:49am  
 04/25/11 02:00pm  
 ADVISOR: DAVID PEREZ

LABOR INSTRUCTIONS

COMMENTS:  
 WAIT (SHUTTLE RIDE)  
 C 02CH2 ENGINE DRIVABILITY  
 CIS: WAS DRIVING CAR IN PARKING LOT, WENT OVER A SPEED BUMP  
 AND THE AIRBAG WENT OFF...ADVISE

PLEASE READ CAREFULLY, CHECK ONE OF THE STATEMENTS BELOW, AND SIGN: I UNDERSTAND THAT UNDER STATE LAW, I AM ENTITLED TO A WRITTEN ESTIMATE, IF MY FINAL BILL WILL EXCEED \$100.00

I REQUEST A WRITTEN ESTIMATE.

I DO NOT REQUEST A WRITTEN ESTIMATE AS LONG AS THE REPAIR COSTS DO NOT EXCEED \$ . THE SHOP MAY NOT EXCEED THIS AMOUNT WITHOUT MY WRITTEN OR ORAL APPROVAL.

I DO NOT REQUEST A WRITTEN ESTIMATE.



ORG DTGS 1 01 3

INTERNAL 1

MINUTES: 751 16N CNTS: 0

DTG 2 01 3

DRIVER SHORT

SHORT TO BILL

MINUTES: 23759 16N



126 11/15/00

DRIVER: [illegible]

DTC: 2

DRIVER: 30500

SHORT TO BATTERY

MINUTES: 23759





ORV DTG 1 of 3

STORED ENERGY

FIRING 1

MINUTES: 720 IGN CNTS: 0

DTG 1 of 3

INTERNAL 1

MINUTES: 753 IGN CNTS: 0



DRG 115 2 of 3

DRIVER SOUB 1

SHORT TO BATTERY

MINUTES: 23759 IGN CNTS: 99

- DIC 3 of 3 -

STORED ENERGY

FIRING

MINUTES: 724 IGN CNTS: 1















25

20

15









Wheeler

30  
25  
20  
15  
10





32

28

24

20

16

12

8





• 35

• 30

• 25

• 20





19

15

11

7



40

35

30

25















TRZME028244  
PSC01031044







TRZME0282A4261  
P56010319AB  
39754C































**jiffylube**



**Your next Jiffy Lube  
Signature Service<sup>®</sup>  
Oil Change is due at:**

**98712 MILES**

**Date of last service:  
2/1/2011**

**2049 BEE RIDGE RD.  
FL- [REDACTED]**