

PE11-020

NISSAN

8/31/2011

ATTACHMENT A

C PAGE 114

D PAGE 117

E PAGE 125

F PAGE 127

G PAGE 132

List of Actions PAGE 147

PE11-020

NISSAN

8/31/2011

ATTACHMENT A

QUESTION 5



2007 WARRANTY INFORMATION BOOKLET

NOTICE:

The coverage period of the New Vehicle Limited Warranty applicable to your Nissan vehicle equipped with Continuously Variable Transmission is extended to 10 years/120,000 miles, whichever comes first, for transmission repairs, replacement and related towing only. The warranty, including all terms, limitations and conditions, otherwise remains unchanged.

| | | | |
|-----------|--|-----------|--|
| 1 | SUMMARY OF WARRANTY COVERAGE AT A GLANCE | 14 | SEAT BELT LIMITED WARRANTY |
| 2 | NISSAN'S CUSTOMER CARE PROGRAM | 15 | BFGOODRICH TIRE LIMITED WARRANTY |
| 3 | NISSAN'S COMMITMENT TO CUSTOMER SATISFACTION | 17 | BRIDGESTONE / FIRESTONE TIRE LIMITED WARRANTY |
| 4 | 2007 NEW VEHICLE LIMITED WARRANTY | 19 | DUNLOP PASSENGER TIRE LIMITED WARRANTY |
| 7 | FEDERAL VEHICLE EMISSION CONTROL LIMITED WARRANTIES | 23 | GENERAL TIRE LIMITED WARRANTY |
| 10 | CALIFORNIA VEHICLE EMISSION CONTROL WARRANTIES | 26 | GOODYEAR TIRE LIMITED WARRANTY |

TABLE OF CONTENTS

| | | | |
|----|--|----|--|
| 28 | MICHELIN TIRE LIMITED WARRANTY | 41 | GENUINE NISSAN ORIGINAL EQUIPMENT MUFFLER, GENUINE NISSAN SHOCK ABSORBER AND STRUT LIFETIME LIMITED WARRANTY |
| 30 | TOYO TIRE LIMITED WARRANTY | | |
| 32 | ORIGINAL EQUIPMENT TIRE LIMITED WARRANTIES | 43 | REPLACEMENT BATTERY LIMITED WARRANTY |
| 33 | IMPORTANT TIRE SAFETY INFORMATION | 44 | GENUINE NISSAN PARTS AND ACCESSORIES |
| 38 | LIMITED WARRANTY ON GENUINE NISSAN REPLACEMENT PARTS, GENUINE NISMO S-TUNE PARTS, AND GENUINE NISSAN ACCESSORIES | 45 | CORROSION PROTECTION GUIDELINES |
| 40 | SUMMARY OF NISSAN LIFETIME REPLACEMENT PANEL CORROSION WARRANTY | 46 | NISSAN'S SECURITY+PLUS [®] VEHICLE PROTECTION PLAN |

Summary of Warranty Coverage*

| | 0 miles | 90,000 miles |
|---|--------------------------------------|--------------|
| Basic Coverage | 36 months / 36,000 miles | |
| Corrosion Coverage (Perforation) | 60 months / UNLIMITED MILEAGE | |
| Powertrain Coverage | 60 months / 60,000 miles | |
| Federal Emission Performance | 24 months / 24,000 miles | |
| Federal Emission Defect | 36 months / 36,000 miles | |
| Federal Emission Long Term Defect | 96 months / 80,000 miles | |
| California Emission Performance | 36 months / 50,000 miles** | |
| California Emission Defect | 36 months / 50,000 miles** | |
| California Emission Long Term Defect | 84 months / 70,000 miles** | |
| Seat Belt | 120 months/unlimited mileage | |

* See the express terms of the appropriate warranty printed in this booklet, which terms control if there is a conflict with this chart.

California Emission Altima with 2.5 engine **ONLY: Warranty coverage is 15 years/150,000 miles, whichever occurs first.

NISSAN CARES...

Both Nissan and your Nissan dealer are dedicated to serving all your automotive needs. Your complete satisfaction with your vehicle and your Nissan dealer are our primary concerns. Your Nissan dealer is always available to assist you with all your automobile service requirements.

If, however, a situation arises that you believe has not been addressed to your satisfaction, we ask that you take the following steps:

STEP 1:

Discuss the situation with the dealership's manager. If a problem still exists, contact the dealership's Consumer Affairs Manager or owner. They are best equipped to resolve the matter for you.

STEP 2:

If the concern has still not been addressed to your satisfaction, please contact our (Nissan's) Consumer Affairs Department using our toll free number:



1-800-NISSAN-1
(1-800-647-7261)

The Consumer Affairs Department will ask for the following information:

- Your name, address, and telephone number
- Vehicle identification number (on dashboard)
- Date of purchase
- Current odometer reading
- Your Nissan dealer's name
- Details of the concern

Or you can write to Nissan with the above information at:

Nissan North America, Inc.
Consumer Affairs Department
P.O. Box 685003
Franklin, TN 37068-5003

STEP 3:

In the event that you believe Nissan has been unable to satisfactorily address the issue with your vehicle, a special automotive complaint resolution program called BBB AUTO LINE is available to you. The BBB AUTO LINE program is independently operated by the Council of Better Business Bureaus, Inc. (BBB).

For information about the BBB AUTO LINE in your area, please call us (Nissan) at the same toll free number (1-800-NISSAN-1). We will be happy to provide you with information about BBB AUTO LINE. Or, you may contact the BBB directly at:

BBB Auto Line
Council of Better Business Bureaus, Inc.
4200 Wilson Blvd.
Arlington, VA 22203
1 (800) 955-5100

If you call the BBB, its staff will take down details of your complaint by telephone. They will ask for the same information as described in Step 2.

The BBB AUTO LINE program consists of two parts, **mediation** and **arbitration**. The BBB will attempt to assist you to resolve the problem during mediation. If a satisfactory resolution has not been achieved during mediation, you will have the opportunity to personally present your case before an impartial arbitrator or three-person panel. The arbitrator(s) will make a decision after the arbitration hearing.

The BBB will, in most cases, send you a final decision within forty (40) days (plus 7 if you have not contacted the proper person from the dealership or Nissan) unless you delay the process. If you accept the decision, it will be legally binding on you and Nissan. If you do not accept the decision, it will not be legally binding on you or Nissan. (However in some states, if the decision is not accepted, it may be introduced either by you or by Nissan, as evidence in any potentially related court action.)

BBB AUTO LINE is an informal dispute settlement mechanism operated to comply with applicable Federal law and regulations. In states where BBB AUTO LINE is available, you are required to use BBB AUTO LINE before exercising rights or seeking remedies under Title I of the Federal Magnuson-Moss Warranty Act, 15 U.S.C. §2301, et. seq. If you choose to seek remedies other than those created by Title I of the Magnuson-Moss Warranty Act, (for example, under state law), that Federal Act does not require you to first use BBB AUTO LINE. The program is still available to you, however, and may be of considerable assistance. Some states specify that informal dispute settlement mechanisms such as BBB AUTO LINE must be used before you may use state-operated complaint resolution processes, before you may file a lawsuit under state law, and/or before you may have certain other rights or remedies available under state law. In accordance with those states' laws, Nissan requires the prior use of BBB AUTO LINE in good faith before you resort to such other processes, file a lawsuit, or seek other remedies provided by state law. Please see the "2007 Nissan Warranty Information Booklet & 2007 Nissan Owner's Manual" for additional information.

BBB AUTO LINE may not be available in all states. We, Nissan, would be pleased to provide you with information about the availability of BBB AUTO LINE in your state, or call the BBB AUTO LINE number listed above.

Nissan vehicles less than three years old from date of original delivery with fewer than 36,000 miles, are eligible for the BBB AUTO LINE program.

ASSISTANCE OUTSIDE OF WARRANTY

In our continuing effort to convey our commitment to service and customer satisfaction, Nissan may occasionally offer to pay or reimburse for part or all of the cost of making certain, specific repairs beyond or outside of the terms of the warranty for some specific vehicle models. (Some states refer to such programs as "adjustment programs"). In such circumstances Nissan mails notices to all known registered owners of affected vehicles. You may additionally inquire of your authorized Nissan Dealer or of Nissan directly at the number listed below of the applicability of such programs to your vehicle.

Nissan may occasionally offer special assistance that may pay for part or all of vehicle repairs beyond the expiration of the limited warranty period on a case by case basis. Should you experience unusual difficulties with your vehicle please discuss the situation with your dealer. If your dealer is unable to assist you, you may call the Nissan Consumer Affairs Department at 1-800-NISSAN-1 to discuss your concern. You will need to provide the Model, Model Year, VIN (Vehicle Identification Number), mileage, maintenance history, a detailed explanation of the concern, and why you believe that Nissan should be responsible for the repair. Your request will be individually investigated and you will be informed of Nissan's decision.



1-800-NISSAN-1
(1-800-647-7261)

Please also review the "Supplement to the 2007 Nissan Warranty Information Booklet & 2007 Nissan Owner's Manual" for important information concerning consumer rights in your state.

WHO IS THE WARRANTOR

Nissan¹ warrants all parts of your 2007 Nissan vehicle supplied by Nissan, except for those listed elsewhere under the caption "WHAT IS NOT COVERED."

APPLICABILITY

- This warranty is provided to the original and subsequent owner(s) of a Nissan vehicle originally distributed by Nissan which is originally sold by a Nissan authorized Nissan dealership in the United States, and which is registered in the U.S. and normally operated in the United States (including Alaska and Hawaii), the United States territories (specifically Guam, Saipan, American Samoa, Puerto Rico and the U.S. Virgin Islands), and Canada.
- This warranty is generally transferable from the original 'owner other than a Nissan dealer' (OWNER) to subsequent owners of the vehicle at any time ownership of the vehicle is transferred, without any action on your part; except that this warranty is not transferable but is instead void if during the first six months after delivery to the original OWNER: (1) ownership of the vehicle is transferred from the original OWNER, and (2) the vehicle is registered outside of the United States.
- Your Nissan vehicle is manufactured to meet U.S. regulations and environmental requirements. With the exception of privately owned vehicles belonging to members of the U.S. military or employees and officers of the United States Government stationed abroad, this warranty does not apply if an otherwise covered vehicle is operated in, or relocated to, a country other than those listed above under this caption, except that it continues to apply if the vehicle is operated in full compliance with its proper use as described in the applicable OWNER'S MANUAL² while touring outside of the United States, the U.S. territories or Canada for a period not exceeding sixty (60) consecutive days or sixty (60) days in any one 12 month period. Subject to the transferability restriction described above, this

warranty applies to a relocated vehicle which is returned to, and is registered and normally operated in the United States, the U.S. territories or Canada, except for conditions due to the vehicle's foreign operation, e.g., use of inappropriate fuels or other fluids.

LIMITATION OF WARRANTIES AND OTHER WARRANTY TERMS AND STATE LAW RIGHTS**EXTRA EXPENSES - LIMITATIONS OF DAMAGES**

This warranty does not cover incidental or consequential damages such as loss of the use of the vehicle, inconvenience or commercial loss.

ANY IMPLIED WARRANTY OF MERCHANTABILITY AND FITNESS FOR A PARTICULAR PURPOSE SHALL BE LIMITED TO THE DURATION OF THIS WRITTEN WARRANTY.

Some states do not allow the exclusion or limitation of incidental or consequential damages or limitations on how long an implied warranty lasts, so the above limitations or exclusions may not apply to you. This warranty gives you specific legal rights, and you may also have other rights which vary from state to state.

Nissan does not authorize any person to create for it any other warranty, obligation or liability in connection with this vehicle.

Nissan makes available to you, and you are specifically required by Federal Law to use BBB AUTO LINE [(800) 955-5100] before exercising rights or seeking remedies under the Federal Magnuson-Moss Warranty Act, 15 U.S.C. §2301, et. seq. You are not required to first use BBB AUTO LINE if you seek remedies not created by Title I of that Federal law, but are required to first use BBB AUTO LINE if you seek remedies created by state law, including your state's lemon law, if applicable state law provides for using a 703 compliant or similar process before filing suit. Please refer to pp. 2-3 of this booklet and the "Supplement to 2007 Nissan Warranty Information Booklet & 2007 Nissan Owner's Manual" for additional information.

THE WARRANTY BEGINS

The warranty period begins on the date the vehicle is delivered to the first retail buyer or put into use, whichever is earlier.

FOR HOW LONG AND WHAT IS COVERED**■ BASIC COVERAGE**

- The basic coverage period is 36 months or 36,000 miles, whichever comes first.
- This warranty covers any repairs needed to correct defects in materials or workmanship of all parts and components of each new Nissan vehicle supplied by Nissan except for the exclusions or items listed under the caption "WHAT IS NOT COVERED" or, if the part is covered by one of the separate coverages described in the following sections of this warranty, that specific coverage applies instead of the basic coverage.
- Bedliners will be repaired to commercially acceptable standards subject to the conditions and limitations listed in "WHAT IS NOT COVERED."

■ POWERTRAIN COVERAGE

- The Powertrain coverage period is 60 months or 60,000 miles, whichever comes first.
- This warranty covers any repairs needed to correct defects in materials or workmanship.
- Powertrain coverage applies to components listed below, supplied by Nissan except for those items listed under the caption "WHAT IS NOT COVERED".

ENGINE

Cylinder heads and block and all internal parts, rocker covers and oil pan, valve train and front cover, timing chain and tensioner, oil pump, water pump and fuel pump, fuel injectors, intake and exhaust manifolds and supercharger, flywheel, seals, and gaskets.

TRANSMISSION AND TRANSAXLE

Case and all internal parts, torque converter and converter housing, automatic transmission control module, transfer

¹ Nissan indicates Nissan North America, Inc., P.O. Box 685003, Franklin, TN 37068-5003 which distributes Nissan vehicles in the United States.

² See the Owner's Manual for information relevant to proper operation of the vehicle, including the recommended fuels and fluids.

case and all internal parts, seals and gaskets, clutch cover and housing, and electronic transmission controls.

DRIVETRAIN

Drive shafts, final drive housing and all internal parts, propeller shafts, universal joints, bearings, seals and gaskets.

RESTRAINT SYSTEM

Air bags and related electronic control systems.

■ **CORROSION COVERAGE (PERFORATION FROM CORROSION)**

Any body sheet metal panel supplied by Nissan found to have developed perforation (rust-through) due to corrosion in normal use is covered for 60 months, regardless of mileage, except for those items listed under "WHAT IS NOT COVERED". No additional rust proofing applications are required. Perforation is a condition in which any body sheet metal panel has corroded from one surface through to another.

■ **ORIGINAL EQUIPMENT BATTERY COVERAGE**

The coverage period is 36 months or 36,000 miles, whichever comes first. A defective original equipment battery which is unserviceable within the first 12 months and 36,000 miles will be replaced free of charge. After 12 months but within 24 months and 36,000 miles, you will pay 50% of the replacement battery's suggested retail price plus any applicable taxes. After 24 months but within 36 months and 36,000 miles, you will pay 75% of the replacement battery's suggested retail price plus any applicable taxes. Nissan will pay the rest, including all labor to remove and replace the defective battery.

■ **TOWING COVERAGE**

If your vehicle is inoperative due to the failure of a warranted part, towing service to the nearest authorized Nissan dealer is covered for 36 months or 36,000 miles, whichever comes first.

■ **ADJUSTMENT COVERAGE**

Service adjustments not usually associated with the replacement of parts, such as wheel alignment, are covered only during the first 12 months or 12,000 miles, whichever comes first.

■ **REFRIGERANT RECHARGE ONLY COVERAGE**

Refrigerant recharge not associated with the repair or replacement of a warranted part is covered only during the first 12 months, regardless of the mileage.

NO CHARGE

Warranty repairs will be made at no charge for parts and/or labor (except for batteries and tires, in which case you may pay certain charges as noted above or as described in the applicable tire warranty found later in this booklet). **Any needed parts replacement will be made using genuine Nissan or Nissan approved new or remanufactured parts.**

OBTAINING WARRANTY SERVICE

- You must take the vehicle to an authorized Nissan dealer in the United States or Canada during regular business hours at your expense in order to obtain warranty service. The names and addresses of authorized Nissan dealers are listed in telephone directories.
- If you require warranty service outside of the United States (see terms under caption "APPLICABILITY"), contact an authorized Nissan dealer in that country. Note that complaints related to failure to comply with proper use of the vehicle as described in the applicable OWNER'S MANUAL (including the lack of availability or use of proper

fuel and fluids), or the vehicle's lack of compliance with local regulations or environmental requirements of any country (other than the U.S., the listed U.S. territories or Canada) are not covered by this warranty.

MAINTENANCE AND RECORDS

As a condition of this warranty, you are responsible for properly using, maintaining and caring for your vehicle as outlined in your OWNER'S MANUAL and your NISSAN SERVICE & MAINTENANCE GUIDE, and maintaining copies of all maintenance records & receipts for review by Nissan. Failure to do so is likely to result in the denial of warranty coverage.

Evidence of the performance of the required maintenance should be kept and presented as proof of such maintenance in connection with related warranty repairs. To assist you in maintaining appropriate records, the maintenance log located in your NISSAN SERVICE & MAINTENANCE GUIDE can be used along with supporting repair invoices, receipts and other such records.

(Continued on page 6)

**(See following page for
"WHAT IS NOT COVERED.")**

WHAT IS NOT COVERED **DAMAGE, FAILURES OR CORROSION DUE TO** **ACCIDENTS, MISUSE OR ALTERATIONS**

This warranty does not cover damage, failures or corrosion resulting from:

- Accident, theft, fire, driving through water (including engine water ingestion) or misuse, which includes racing of any sort whatsoever (Proper use is outlined in your OWNER'S MANUAL).
- Alteration, tampering or improper repair.
- Installation of non-Nissan approved accessories or components.
- Improper installation of any Nissan approved or aftermarket accessory or component.
- Glass breakage, unless resulting from defects in material or workmanship.
- Normal wear and tear, including dings, dents, chips or scratches.

ALTERED OR UNCERTAIN ODOMETER MILEAGE

This warranty does not cover repair of any vehicle or any part of a vehicle of which the odometer mileage has been altered, or the odometer repaired or replaced and the actual vehicle mileage cannot be correctly and readily determined.

SALVAGE TITLE

This limited warranty does not apply to any vehicle, and is rendered void if the vehicle is (or ever has been) issued a "salvage" or similar title under any state's law; or has ever been determined to be a "total loss" or equivalent by any insurance company, such as by payment of a cash payment of claim in lieu of repairs because of a determination that the cost of repairs exceeded the actual cash value of the vehicle.

DAMAGE, FAILURES OR CORROSION FROM **ENVIRONMENTAL CONDITIONS**

This warranty does not cover damage, failures or corrosion resulting from:

- Stone chipping, chemical fallout (acid rain), tree sap, salt, hail, wind-storm, lightning, flood or other environmental conditions.

- The items listed below are not covered under corrosion coverage (perforation from corrosion).
 - Exhaust system components.
 - Corrosion of outer trim parts, such as moldings. However, corrosion of outer trim parts is warranted for 12 months or 12,500 miles, whichever comes first.
 - Corrosion other than perforation, such as cosmetic or surface corrosion due to defects in materials or workmanship. This is covered under the Basic Coverage of the New Vehicle Limited Warranty.
 - Special bodies or equipment not manufactured or supplied by Nissan.

DAMAGE, FAILURES OR CORROSION DUE TO LACK **OF OR IMPROPER MAINTENANCE**

This warranty does not cover damage, failures or corrosion resulting from:

- Lack of performance of proper maintenance services as outlined in your NISSAN SERVICE & MAINTENANCE GUIDE.
- Use of improper or dirty fuel, fluids or lubricants.
- Use of parts not equivalent in quality or design to parts supplied by Nissan.

MAINTENANCE SERVICE EXPENSE

This warranty does not cover normal maintenance services as specified in your NISSAN SERVICE & MAINTENANCE GUIDE such as engine tune-up; cleaning and polishing; wheel alignment; headlight aiming; replacement of filters, replacement of windshield wiper inserts, replacement of key fob batteries, lubricants, coolant; worn brake shoes, pads, drums and rotors and worn clutch discs.

SEAT BELTS, TIRES, DROP-IN BEDLINERS AND **EMISSION CONTROL SYSTEM**

Seat belts, tires, drop-in bedliners and the emission control system are not covered by this warranty, but are covered by separate warranties.

NISSAN SPRAY-IN BEDLINERS

Nissan Spray-in Bedliners will be repaired to commercially acceptable standards which may include minor appearance differences from the original bedliner.

(See following pages for separate warranties which may apply to your Nissan, such as those covering vehicle emissions, seat belts, and tires.)

EMISSION DEFECTS WARRANTY

Nissan¹ warrants that your vehicle was designed, built and equipped to conform at the time of sale with all applicable United States emission standards.

This warranty covers any repairs needed to correct defects in materials or workmanship which would cause your vehicle not to meet these standards.

WHAT IS COVERED UNDER THE DEFECTS WARRANTY

Covered components are listed below under the caption "WARRANTY PARTS LIST." Exceptions to this warranty are listed below under the caption "WHAT IS NOT COVERED UNDER EITHER THE DEFECTS OR PERFORMANCE WARRANTIES."

HOW LONG IS THE DEFECTS WARRANTY

This warranty is for 3 years or 36,000 miles, whichever occurs first. The warranty begins the date the vehicle is delivered to the first retail buyer or put into use, whichever is earlier. Additionally, the engine control module/onboard diagnostic device and catalytic converter(s) listed below and indicated by an "O" under the caption "Warranty Parts List" are covered for 8 years or 80,000 miles, whichever occurs first.

EMISSIONS PERFORMANCE WARRANTY WHEN DOES THIS WARRANTY APPLY

The Emission Performance warranty applies to your 2007 Nissan vehicle ONLY when both of the following occur.

1. The vehicle fails to meet applicable emissions standards as judged by an emissions test approved by the Environmental Protection Agency (EPA).

2. This failure results or will result in some penalty to you, such as a monetary fine or the denial of the right to use your vehicle, under local, state or federal law.

For example, if your state requires an EPA approved yearly vehicle inspection before you receive a renewed license, this warranty applies to your vehicle. In areas where there is no approved test program, this warranty does not apply.

WHAT IS COVERED AND FOR HOW LONG UNDER THE PERFORMANCE WARRANTY

Nissan¹ warrants that it will remedy any non-conformity in your vehicle which causes it to fail an approved emissions test during the first 24 months or 24,000 miles, whichever occurs first. This warranty begins the date the vehicle is delivered to the first retail buyer or put in to use, whichever is earlier.

Additionally, failure of an approved emissions test resulting from the failure of those parts listed below under the caption "Warranty Parts List" are covered by the Emissions Defects Warranty described above.

Exceptions to this warranty are listed below under the caption "WHAT IS NOT COVERED UNDER EITHER THE DEFECTS OR PERFORMANCE WARRANTIES."

LIMITATION OF WARRANTIES AND OTHER WARRANTY TERMS AND STATE LAW RIGHTS**EXTRA EXPENSES - LIMITATIONS OF DAMAGES**

These emissions warranties do not cover incidental or consequential damages such as loss of the use of the vehicle, inconvenience or commercial loss.

ANY IMPLIED WARRANTY OF MERCHANTABILITY AND FITNESS FOR A PARTICULAR PURPOSE SHALL BE LIMITED TO THE DURATION OF THESE WRITTEN WARRANTIES.

Some states do not allow the exclusion or limitation of incidental or consequential damages or limitations on how long an implied warranty lasts, so the above limitations or exclusions may not apply to you. These warranties give you specific legal rights, and you may also have other rights which vary from state to state.

Nissan does not authorize any person to create for it any other warranty, obligation or liability in connection with this vehicle.

(Continued on page 8)

¹ Nissan indicates Nissan North America, Inc., P.O. Box 685003, Franklin, TN 37068-5003 which distributes Nissan vehicles in the United States.

WHAT IS NOT COVERED UNDER EITHER THE DEFECTS OR PERFORMANCE WARRANTIES

These warranties do not cover:

1. Normal maintenance, service and parts replacement as outlined in the emissions control maintenance instructions of your OWNER'S MANUAL and your NISSAN SERVICE & MAINTENANCE GUIDE.
2. Failures directly as a result of:
 - Failure to perform required emission control maintenance as outlined in your OWNER'S MANUAL and your NISSAN SERVICE & MAINTENANCE GUIDE.
 - Misuse, accident or modification.
 - Improper adjustment or installation of parts during the performance of maintenance services.
 - Tampering with or disconnecting any part affecting vehicle emissions.
 - The use of contaminated fuel or fuel other than that specified in your OWNER'S MANUAL.
3. In the case of the Performance Warranty, the use of any part not certified in accordance with Federal requirements which is defective or not equivalent from an emissions standpoint to the original equipment part.
4. In the case of the Performance Warranty, costs of determining the cause of a vehicle failing an EPA approved emissions test if such failure is found not to be covered.
5. In the case of the Defects Warranty, parts not supplied by Nissan or damage to other parts caused directly by non-Nissan parts.

WHAT YOU MUST DO

In order to obtain warranty service you must deliver the vehicle to an authorized Nissan dealer in the United States at your expense.

You must also maintain your vehicle as outlined in the maintenance instructions in your NISSAN SERVICE & MAINTENANCE GUIDE.

WHAT NISSAN WILL DO

Warranty repairs will be made at no charge for parts and/or labor, including diagnosis and tax. Any needed parts replacement will be made using new or remanufactured parts.

OTHER WARRANTY TERMS PERFORMANCE WARRANTY CLAIMS PROCEDURE

You may make a claim under the Performance Warranty immediately after the failure of an EPA approved emissions test. You must provide proof of this failure when making your claim.

You will be told whether Nissan will honor your claim within 30 days of the date you make the claim unless a shorter time period is required by law. If your claim is denied, Nissan will notify you in writing of the reason. If we do not notify you within this time period, we will repair your vehicle under this warranty at no cost to you. The time period for notification will not apply if you request a delay or a delay is caused by events not under the control of Nissan dealers.

No claim will be denied under the Performance Warranty

because you use a non-Nissan but EPA certified part for maintenance or repair.

MAINTENANCE SERVICE AND REPLACEMENT PARTS

Important information concerning maintenance service and replacement parts is in the Limited Warranty on Nissan Parts and Accessories section of this booklet.

MAINTENANCE RECORDS

Receipts covering the performance of regular maintenance should be kept in the event questions arise concerning maintenance. The receipts should be transferred to subsequent owners.

IF YOU HAVE QUESTIONS

You may obtain further information concerning these warranties by following the procedure outlined in the "CUSTOMER CARE" section of this booklet. In the case of the Performance Warranty, you may also contact or report any violations to the Office of Transportation and Air Quality, Vehicle Compliance Programs Group, U.S. Environmental Protection Agency, Ariel Rios Building (6405J), 1200 Pennsylvania Avenue, N.W, Washington, D.C. 20460

(Continued on page 9)

WARRANTY PARTS LIST

- Fuel injection system
- Engine control module/onboard diagnostic device
- Oxygen sensor(s)
- Mass air flow sensor
- Intake manifold
- Throttle body
- Catalytic converter(s)
- Exhaust manifold(s)
- Exhaust tube from manifold to catalytic converter
- Camshaft position sensor(s)
- Crankshaft position sensor(s)
- Spark plugs, ignition coil and wires
- Ignition control module
- Evaporative emission control system
- Fuel filler neck restrictor and check valve
- Fuel tank and filler cap
- Idle air control system
- Positive crankcase ventilation system
- Exhaust gas recirculation (EGR) control system
- Pulsed secondary air injection system and valves
- Hoses, clamps, fittings, tubing, sealing gaskets or devices and mounting hardware used in above systems
- Vacuum and temperature sensitive valves and switches used in above systems
- Electronic sensors and controls used in above systems

The Emission Performance or Defect Warranty may be subject to future governmental administrative action. Nissan reserves the right to change the terms of the warranty to be consistent with these actions. See your dealer for information regarding possible changes.

The following statement is required to be provided by regulations of the California Air Resources Board.

YOUR WARRANTY RIGHTS AND OBLIGATIONS

The California Air Resources Board is pleased to explain the emission control system warranty on your 2007 vehicle.³ In California, new motor vehicles must be designed, built and equipped to meet the State's stringent anti-smog standards. Nissan⁴ must warrant the emission control system on your vehicle for the periods of time listed below provided there has been no abuse, neglect or improper maintenance of your vehicle.

Your emission control system may include parts such as the fuel-injection system, the ignition system, catalytic converter and engine computer. Also included may be hoses, belts, connectors and other emission-related assemblies.

Where a warrantable condition exists, Nissan will repair your vehicle at no cost to you including diagnosis, parts and labor.

MANUFACTURER'S WARRANTY COVERAGE⁵

For 3 years or 50,000 miles (whichever occurs first):

- 1) If your vehicle fails a Smog Check inspection, all necessary repairs and adjustments will be made by Nissan to ensure that your vehicle passes the inspection. This is your emission control system

PERFORMANCE WARRANTY.

- 2) If any emission-related part on your vehicle is defective, the part will be repaired or replaced by Nissan. This is your short-term emission control system DEFECTS WARRANTY.

For 7 years or 70,000 miles (whichever occurs first):

If an emission-related part listed in this warranty booklet specially noted with coverage for 7 years or 70,000 miles is defective, the part will be repaired or replaced by Nissan. This is your long-term emission control system DEFECTS WARRANTY.

OWNER'S WARRANTY RESPONSIBILITIES

As the vehicle owner, you are responsible for the performance of the required maintenance listed in your owner's manual. Nissan recommends that you retain all receipts covering maintenance on your vehicle, but Nissan cannot deny warranty solely for the lack of receipts or for your failure to ensure the performance of all scheduled maintenance.

You are responsible for presenting your vehicle to a Nissan dealer as soon as a problem exists. The warranty repairs should be completed in a reasonable amount of time, not to exceed 30 days.

As the vehicle owner, you should also be aware that Nissan may deny you warranty coverage if your vehicle or a part has failed due to abuse, neglect, improper maintenance or unapproved modifications.

If you have any questions regarding your warranty rights and responsibilities, you should contact Nissan's Consumer Affairs Department at 1-800-NISSAN-1 (1-800-647-7261) or the California Air Resources Board at 9528 Telstar Avenue, El Monte CA 91731.

(Continued on page 11)

¹ These warranties apply to all California and 50-state emission equipped 2007 model year Nissan vehicles sold for registration as new vehicles in California, Maine, Massachusetts, or Vermont only.

² These warranties also apply to all Model Year 2007 Partial Zero Emissions Vehicles (PZEVs) sold in the states of New York, Maine, Massachusetts, Rhode Island, Connecticut or Vermont.

³ Throughout this Limited Emission Control Warranty, "vehicle" means a Nissan model vehicle.

⁴ Nissan indicates Nissan North America, Inc., P.O. Box 685003, Franklin, TN 37068-5003 which distributes Nissan vehicles in the United States.

⁵ The performance and defect warranty coverage for the California Emission Altima with 2.5 engine ONLY is 15 years/150,000 miles, whichever occurs first.

The following is Nissan's new vehicle emission control warranty statement for vehicles certified for sale in California and sold for registration as a new vehicle in California, Maine, Massachusetts, or Vermont only.

LIMITATION OF WARRANTIES AND OTHER WARRANTY TERMS AND STATE LAW RIGHTS

EXTRA EXPENSES - LIMITATIONS OF DAMAGES
These emissions warranties do not cover incidental or consequential damages such as loss of the use of the vehicle, inconvenience or commercial loss.

ANY IMPLIED WARRANTY OF MERCHANTABILITY AND FITNESS FOR A PARTICULAR PURPOSE SHALL BE LIMITED TO THE DURATION OF THESE WRITTEN WARRANTIES.

Some states do not allow the exclusion or limitation of incidental or consequential damages or limitations on how long an implied warranty lasts, so the above limitations or exclusions may not apply to you. These warranties give you specific legal rights, and you may also have other rights which vary from state to state.

Nissan does not authorize any person to create for it any other warranty, obligation or liability in connection with this vehicle.

EMISSIONS DEFECTS WARRANTY

WHAT IS COVERED

Nissan warrants that your vehicle was designed, built and equipped to conform with all applicable requirements of the California Air Resources Board. This warranty covers any part which affects applicable regulated emission(s).

Exceptions to this warranty are listed below under the caption "WHAT IS NOT COVERED."

HOW LONG IS THE WARRANTY⁵

This warranty is for 3 years or 50,000 miles, whichever occurs first. Additionally, the components listed under the caption "Long-Term Emission System Defects Warranty Parts List" are covered for 7 years or 70,000 miles, whichever occurs first, except that the catalytic converter and engine control module (ECM) are warranted for 8 years or 80,000 miles, whichever occurs first. The warranty begins the date the vehicle is delivered to the first retail buyer or put into use, whichever is earlier.

Some items require scheduled replacement before 50,000 miles. These items are warranted only up to the replacement interval. The replacement intervals are outlined in the maintenance instructions in your NISSAN SERVICE & MAINTENANCE GUIDE.

LONG-TERM EMISSION SYSTEM DEFECTS WARRANTY PARTS LIST

- Engine control module (all models).
- Catalytic converter(s) (Altima w/3.5 engine, Maxima, 350Z, Quest, Murano, Frontier w/4.0 engine, Xterra, Pathfinder).
- Intake manifold (Versa, Sentra, 350Z, Murano, Frontier w/2.5 engine).
- Intake manifold collector (Murano lower only).
- Exhaust manifold (Versa, Sentra, Maxima rear only, 350Z, Frontier w/4.0 engine RH only, Xterra RH only, Pathfinder RH only).
- Exhaust manifold with catalytic converter (Titan, Armada).
- Front exhaust tube (350Z).
- Front exhaust tube with catalytic converter (Versa, Sentra, Altima w/3.5 engine, Murano).
- Throttle body (Versa, Sentra, Altima w/3.5 engine, Maxima, 350Z, Quest, Murano, Frontier, Xterra, Pathfinder, Titan, Armada).

- Mass air flow sensor (Maxima, Quest, Murano).
- EGI wiring harness (Versa, Sentra, Altima w/3.5 engine, 350Z, Murano, 2WD Titan).
- Fuel tank (Altima w/3.5 engine, Maxima, 350Z, Quest, Murano, Frontier, Xterra, Pathfinder, Titan, Armada).
- Flywheel (Versa, Sentra, Altima w/3.5 engine, 350Z, Frontier, Xterra).
- Torque converter drive plate (Versa, Sentra, Altima w/3.5 engine, Maxima, 350Z, Quest, Murano, Frontier, Xterra, Pathfinder).
- Knock sensor (Frontier w/4.0 engine, Xterra, Pathfinder).
- Automatic transmission control module (Versa, Sentra, Altima w/3.5 engine, Maxima, Quest, Murano).
- Air fuel ratio sensor (Murano).

EMISSIONS PERFORMANCE WARRANTY WHEN DOES THIS WARRANTY APPLY

This warranty applies to your 2007 Nissan vehicle only if it fails to pass a California "smog check" test or equivalent.

WHAT IS COVERED AND FOR HOW LONG⁵

Nissan* warrants that if your vehicle fails to pass a California "smog check" test, it will make the necessary repairs so that your vehicle will pass. This warranty is for 3 years or 50,000 miles, whichever occurs first. The warranty begins the date the vehicle is delivered to the first retail buyer or the date it is first put in to service, whichever is earlier.

Exceptions to this warranty are listed under the caption "WHAT IS NOT COVERED".

(Continued on page 12)

WHAT IS NOT COVERED

These warranties do not cover:

1. Normal maintenance, service and parts replacement as outlined in the emission control maintenance instructions of your OWNER'S MANUAL and your NISSAN SERVICE & MAINTENANCE GUIDE.
2. Failures directly as a result of:
 - Lack of performance of required emission control maintenance as outlined in your OWNER'S MANUAL and your NISSAN SERVICE & MAINTENANCE GUIDE.
 - Misuse, accident or modification.
 - Improper adjustment or installation of parts during the performance of maintenance (non-warranty) services.
 - Tampering with or disconnecting any part affecting vehicle emissions.
 - The use of fuel other than that specified in your OWNER'S MANUAL or fuel with contaminants which the fuel filter is not designed to remove.
3. In the case of the Performance Warranty, the use of any non-Nissan part not certified in accordance with Federal requirements which is defective or not equivalent from an emissions stand point to the original equipment part.
4. In the case of the Defects Warranty, parts not supplied by Nissan or damage to other parts caused directly by non-Nissan parts.
5. In the case of the Performance Warranty, costs of determining the cause of a vehicle failing a California "smog check" test if such failure is found not to be covered.

WHAT YOU MUST DO

In order to obtain warranty service you must deliver the vehicle to any authorized Nissan dealer in the United States at your expense. You are responsible for the required maintenance on your vehicle as outlined in the maintenance instructions in your NISSAN SERVICE & MAINTENANCE GUIDE. Nissan recommends that you retain all receipts covering maintenance on your vehicle, but Nissan cannot deny warranty solely for the lack of receipts or for your failure to ensure the performance of all scheduled maintenance.

WHAT NISSAN WILL DO

Warranty repairs will be made at no charge for parts and/or labor, including diagnosis and tax. Any needed parts re-placement will be made using new or remanufactured parts.

OTHER WARRANTY TERMS**Performance Warranty Claims Procedure**

You may make a claim under the Performance Warranty immediately after the failure of a "smog check" test. You must provide proof of this failure when making your claim in order to avoid additional "smog check" test charges.

You will be told whether Nissan will honor your claim within 30 days of the date you make the claim, unless a shorter time period is required by law. If your claim is denied, Nissan will notify you in writing of the reason. If we do not notify you within this time period, we will repair your vehicle under this warranty at no cost to you. The time period for notification will not apply if you request a delay or a delay is caused by events not under the control of Nissan dealers. No claim will be denied under the Performance Warranty because you use a certified part for maintenance or repair.

Maintenance Service and Replacement Parts

Important information concerning maintenance service and replacement parts is in the Limited Warranty on Nissan Replacement Parts and Accessories section of this booklet. No warranty claim will be denied solely because a non-Nissan part was used for maintenance or repair.

California Vehicle Inspection Program

Under this program, if your vehicle fails a "smog check" test, you may choose to have diagnosis of the failure and repairs made at a Nissan dealer or at another service facility. If the inspection failure is the result of a condition covered by these warranties, you must take your vehicle to an authorized Nissan dealer for warranty repairs. This includes parts, labor and diagnosis. You must pay for diagnostic costs if performed at another service facility except in the case of emergency repairs as outlined below.

You must pay for all diagnostic and repair costs of an inspection failure as required by law if the failure was caused by conditions not covered by these warranties. If the failure is the result of a combination of conditions, you must pay for only the diagnostic and repair costs related to items not covered by these warranties.

After the 3 year/50,000 mile performance warranty has passed, a "smog check" test failure due to a defect in a part which is warranted for 7 years/70,000 miles is covered.⁵

Emergency Repairs

In case of an emergency, when an authorized Nissan dealer is not reasonably available, warranty repairs may be performed at any service facility or by the owner using any replacement parts. Nissan will reimburse you for such repairs, including diagnosis, up to the amount of Nissan's suggested retail price for parts and labor charges based on Nissan's recommended time allowance for the warranty repair and the geographically appropriate hourly

labor rate. A part not being available or a repair not being complete within 30 days also constitutes an emergency. You must take the replaced part and paid receipts to an authorized Nissan dealer for repayment in such emergency situations.

Maintenance Records

Receipts covering the performance of regular maintenance are not required but should be kept in the event questions arise concerning maintenance. The receipts should be transferred to subsequent owners.

If you have Questions

You may obtain further information concerning these warranties by following the procedure outlined in the "CUSTOMER CARE" section of this booklet. You may also contact or report any violations to the Office of Transportation and Air Quality, Vehicle Compliance Programs Group, U.S. Environmental Protection Agency, Ariel Rios Building (6405J), 1200 Pennsylvania Avenue, N.W, Washington, D.C. 20460 or the Chief, Mobile Source Division, Air Resources Board, 9528 Telstar Ave., El Monte, CA. 91731.

Other Obligations

Nissan does not authorize any person to create for it any other warranty, obligation or liability in connection with this vehicle.

Warranty for 2007 vehicles certified for sale in California may be subject to future governmental administrative or judicial action. As a result, this warranty may be changed because Nissan reserves the right to, and, will make those changes required by future law, regulation, or judicial or administrative action in order to be consistent with such governmental actions.

WHO IS THE WARRANTOR

Nissan* warrants all parts of your 2007 Nissan vehicle seat belt system supplied by Nissan.

*Nissan indicates Nissan North America, Inc., P.O. Box 685003, Franklin, TN 37068-5003, which distributes Nissan vehicles in the United States.

WHAT IS COVERED AND FOR HOW LONG

This warranty covers any Nissan supplied seat belt or related component, that fails to function properly during normal use within ten (10) years of the date the vehicle is delivered to the first retail buyer or put into service, whichever is earlier. Warranty repairs are free of charge for parts and labor.

OBTAINING WARRANTY SERVICE

You must take the vehicle to an authorized Nissan dealer in the United States or Canada during regular business hours at your expense in order to obtain warranty service. The names and addresses of authorized Nissan dealers are listed in telephone directories.

WHAT IS NOT COVERED

- Damage or failure due to misuse, alteration, accident or collision damage. (Proper use is outlined in your OWNER'S MANUAL).
- Color fading, spotting or other cosmetic items when the belt is otherwise functioning properly.
- Air bags and related electronic control systems which are covered by the Powertrain warranty.

LIMITATION OF WARRANTIES AND OTHER WARRANTY TERMS AND STATE LAW RIGHTS

EXTRA EXPENSES - LIMITATIONS OF DAMAGES

This warranty does not cover incidental or consequential damages such as loss of the use of the vehicle, inconvenience or commercial loss.

ANY IMPLIED WARRANTY OF MERCHANTABILITY AND FITNESS FOR A PARTICULAR PURPOSE SHALL BE LIMITED TO THE DURATION OF THIS WRITTEN WARRANTY.

Some states do not allow the exclusion or limitation of incidental or consequential damages or limitations on how long an implied warranty lasts, so the above limitations or exclusions may not apply to you. This warranty gives you specific legal rights, and you may also have other rights which vary from state to state.

Nissan does not authorize any person to create for it any other warranty, obligation or liability in connection with this vehicle.

WHO IS COVERED

The owner of a BFGoodrich Passenger or Light Truck tire which bears the BFGoodrich name and complete DOT identification number.

WHAT IS COVERED AND FOR HOW LONG

BFGoodrich Passenger and Light Truck tires, used in normal service on the vehicle on which they were originally fitted and in accordance with the maintenance recommendations and safety warnings contained in the owner's manual and in the Important Tire Safety Information Section of this booklet, are covered by this warranty against defects in workmanship and material for the life of the original usable tread, or 6 years from the date of purchase, whichever comes first. At that time, all warranties, express or implied, are terminated. The usable tread is the original tread down to the level of the tread wear indicators - 2/32nds of an inch (1.6mm) of tread remaining. Date of purchase is documented by new vehicle registration or tire sales invoice. If no proof of purchase, coverage will be based on date of manufacture.

WHAT IS NOT COVERED

Tires which become unserviceable due to:

- Road hazard injury (e.g., a cut, snag, bruise, impact damage, puncture, whether repairable or not);
- Incorrect mounting of the tire, tire/wheel imbalance, or improper repair;
- Underinflation, overinflation, improper maintenance or other abuse;
- Mechanical irregularity in the vehicle such as wheel misalignment resulting in uneven or rapid wear;
- Accident, fire, chemical corrosion, tire alteration, or vandalism;
- Ozone or weather cracking.

WHAT BFGOODRICH WILL DO**PASSENGER AND LIGHT TRUCK TIRES**

A tire which becomes unserviceable due to a condition covered by this warranty will be replaced with a comparable new BFGoodrich tire, free of charge, when 2/32nds of an inch (1.6mm) or less of the original tread is worn, (or 25% or less, whichever is most beneficial to the user) and within 12 months of the date of purchase. Mounting and balancing of tires is included. The cost of any other service charges and applicable taxes are payable by the user.

When more than 2/32nds of an inch of original tread has been worn (or more than 25%, whichever is most beneficial to the user) or after 12 months from date of purchase, the user must pay the cost of a comparable new BFGoodrich passenger or light truck replacement tire on a *pro rata* basis. The dealer shall determine the charge by multiplying the percentage of the original usable tread worn by the current actual selling price at the adjustment location or the price on the current BFGoodrich Brand Base Price List, whichever is lower. This List is based on a predetermined price intended to fairly represent the actual selling price of the tire. The cost of mounting, balancing and any other service charges and applicable taxes are payable by the user.

(Continued on page 16)

WHAT THE CONSUMER MUST DO

When making a claim under the terms of this warranty, the consumer must present the tire to an authorized BFGoodrich Dealer. To locate an Authorized Tire Dealer, check the yellow pages under "Tire Dealers - Retail."

The vehicle on which the tire was used should be available for inspection.

It is essential that you read and understand the safety and maintenance recommendations (see Safety Maintenance Information) for your tires.

CONDITIONS AND EXCLUSIONS

THIS WARRANTY DOES NOT PROVIDE COMPENSATION FOR LOSS OF TIME, LOSS OF USE OF VEHICLE, INCONVENIENCE OR CONSEQUENTIAL DAMAGE.

TIRES PRESENTED FOR CLAIM REMAIN THE PROPERTY OF THE CONSUMER AND BFGOODRICH BRAND ACCEPTS NO RESPONSIBILITY FOR LOSS OF, OR DAMAGE TO, TIRES WHICH ARE IN THE CUSTODY OR CONTROL OF A BFGOODRICH TIRE DEALER FOR THE PURPOSE OF INSPECTION FOR WARRANTY ADJUSTMENT. IN THE EVENT OF A DISPUTED CLAIM, THE CONSUMER MUST MAKE THE TIRE AVAILABLE FOR FURTHER INSPECTION.

NO BFGOODRICH REPRESENTATIVE, EMPLOYEE OR DEALER HAS THE AUTHORITY TO MAKE OR IMPLY ANY REPRESENTATION, PROMISE OR AGREEMENT, WHICH IN ANY WAY VARIES THE TERMS OF THIS WARRANTY.

THIS WARRANTY APPLIES ONLY IN THE UNITED STATES AND CANADA.

CONSUMER RIGHTS

THIS WARRANTY GIVES YOU SPECIFIC LEGAL RIGHTS, AND YOU MAY ALSO HAVE OTHER RIGHTS WHICH VARY FROM STATE TO STATE AND PROVINCE TO PROVINCE.

SAFETY MAINTENANCE INFORMATION

Read your vehicle owners manual, the information on the sidewall of your tires, the vehicle tire information placard and the Important Tire Safety Information section of this booklet for essential safety and maintenance information.

THE WARRANTOR

The warrantor of BFGoodrich Tires is Michelin North America, Inc. 1 Parkway South, P.O. Box 19001, Greenville, South Carolina 29602-9001.

For Consumer Assistance, Please Call Toll Free:
1-877-788-8899

Or Write:

Consumer Relations
P.O. Box 19026, Greenville, SC 29602-9026

DANGER

Disregarding any of the safety precautions and instructions contained in the Owner's Manual or the Important Tire Safety Information in this booklet may result in tire failure or explosion causing serious personal injury or death.

ELIGIBILITY

You are covered under the terms of this warranty if you are the first retail purchaser or authorized agent of the first retail purchaser of any new Bridgestone or Firestone tire bearing the Bridgestone or Firestone name and Department of Transportation (DOT) assigned identification number, produced after July 3, 1994 (274), and if your tire has been used only on the vehicle on which it was originally installed in non-commercial service and is of a size equivalent to or greater than that specified by the vehicle's manufacturer.

WHAT THIS WARRANTY COVERS & FOR HOW LONG

If, (i) before wearing down to 2/32nds of an inch of tread depth remaining (i.e., worn down to the top of the built-in indicators in the tread grooves), (ii) before 6 years from the date of purchase (proof of purchase required), or (iii) before 6 years from the date of manufacture (whichever occurs first), any Bridgestone or Firestone tire covered by this warranty becomes unusable for any reason within the manufacturer's control, such tire will be replaced with an equivalent Bridgestone or Firestone tire on the basis set forth below.

WHAT THE WARRANTY DOES NOT COVER

1. Tire damage or irregular wear due to:

A. Road Hazards.

Including, without limitation, puncture, cut, impact break, bruise, bulge, snag, etc.

B. Continued use while run flat or under acute under-inflation.**C. Improper Use or Operation.**

Including, without limitation, improper inflation pressure, overloading, use of an improper rim, vehicle misalignment, tire/wheel assembly imbalance or other vehicle conditions, worn suspension components, improper mounting or demounting, misuse, misapplication, negligence, tire spinning, tire chain damage, chemical contamination, fire or other externally generated heat, water or other material trapped inside the tire during mounting, tire alteration, racing or competition purposes, improper insertion of sealant, balance or filler materials.

D. Improper Repair.

2. Ride disturbance claims submitted after 1/32nd inch of treadwear or for 4 or more tires from the same vehicle.
3. The cost of applicable federal, state, and local taxes.
4. Tires purchased and normally used outside the continental United States.
5. Claims for weather/ozone cracking after 4 years from the date of purchase (proof of purchase required) or if not known, 4 years from the date of manufacture.
6. Failure to observe any of the safety and maintenance precautions contained in the "Important Tire Safety Information" section of this booklet.

This warranty is in addition to and/or may be limited by any other applicable written warranty concerning special tires or situations you may have received.

"LIMITED WARRANTY" Bridgestone and Firestone Brand Passenger & Light Truck Tires**REPLACEMENT PRICE**

Radial passenger and light truck tires adjusted under this warranty will be replaced free of charge during the first 25% of treadwear or within the first 12 months after purchase (Proof of Purchase and Purchase Date are required), whichever occurs first.

During the free replacement period, mounting and balancing are included free of charge.

After the free replacement period, to determine the replacement price, the percent of used treadwear is multiplied by the owner-user's regular buying price. Taxes, mounting, balancing, and other service charges will be added to the adjustment replacement price.

IN CANADA, the tire will be adjusted at dealerships (subject always to dealer discretion) at a predetermined "Adjustment Price".

Replacement Warranty. If you receive a tire under this warranty, it will be covered by the warranty then given on that tire.

Where to go. See your Bridgestone or Firestone retailer listed in Yellow Pages under Tire Dealers-Retail.

CONSUMER RIGHTS

This warranty gives you specific legal rights, and you may also have other rights which vary from state to state and in Canada from province to province.

(Continued on page 18)

CONDITIONS & EXCLUSIONS

TO THE EXTENT PERMITTED BY LAW, BRIDGESTONE/FIRESTONE, INC. DISCLAIMS LIABILITY FOR ANY CONSEQUENTIAL DAMAGES, LOSS OF TIME, OR LOSS OF VEHICLE USE, OR INCONVENIENCE.

Some states do not allow the exclusion or limitation of incidental or consequential damages, so the above limitation or exclusion may not apply to you.

This warranty applies only to consumers actually using the tire in the United States and Canada. For warranty conditions outside the United States and Canada, see your local Bridgestone or Firestone distributor.

Obligations under this policy may not be enlarged or altered by anyone.

Important: In accordance with Federal Law, this warranty has been designated as a "Limited Warranty". Nothing in this warranty is intended to be a representation that tire failures cannot occur. This warranty is given by Bridgestone/Firestone, Inc., One Bridgestone Park, Nashville, TN 37214 and in Canada by Bridgestone Canada, Inc., 5770 Hurontario St. Suite 400, Mississauga, Ontario, Canada L5R 3G5.

OWNER-USER'S OBLIGATION

It is owner-user's obligation to operate tires within tire load and specification limits and at cold air pressures

specified by your vehicle manufacturer for load and speed according to individual tire size, type, and load capacity. It is also the owner-user's obligation to maintain proper alignment of wheels, and to maintain proper tire/wheel assembly balance.

In case of adjustment claim, owner-user must present the tire to a Bridgestone or Firestone retailer, complete and sign the customer section of the Bridgestone/Firestone, Inc. warranty claim form, and pay appropriate replacement price, taxes and service charges.

We strongly recommend that you have your Bridgestone or Firestone retailer inspect tires any time you notice irregular or uneven treadwear or every 5,000 miles or at vehicle manufacturer's recommended mileage, if sooner.

Note: For your convenience, your nearest authorized Nissan Dealership will also assist you with your Tire Service Requirements or in obtaining tire warranty service from the tire manufacturer.

THE WARRANTOR

The warrantor of Bridgestone and Firestone tires is: Bridgestone/Firestone, Inc., ATTN: Technical Services, One Bridgestone Park, Nashville, TN 37214.

For Customer Assistance:
1-800-847-3272

SAFETY INFORMATION

Any tire, no matter how well constructed, may fail in use as a result of punctures, impact damage, improper inflation, overloading, or other conditions resulting from use or misuse. Tire failure may create a risk of serious personal injury or property damage. To reduce risk of tire failure, we strongly recommend you read and follow all safety information contained in the Important Tire Safety Information section contained in this booklet, the tire placard in the vehicle or the Owner's Manual.

WHO IS ELIGIBLE?

You are eligible for the benefits of this Limited Warranty if:

- You are the owner or authorized agent of the owner of new Dunlop highway auto, light truck or temporary spare tires supplied as original equipment on your vehicle, and
- Your tires bear Department of Transportation prescribed tire identification numbers and your tires have been used only on the vehicle on which they were originally installed according to the vehicle manufacturer or Dunlop recommendations, and
- Your vehicle was purchased on or after March 1, 2003.

WHAT IS COVERED AND FOR HOW LONG?**FREE TIRE REPLACEMENT**

Any Dunlop tire eligible under the provisions of this limited warranty and removed from service due to a covered warranty condition during the first 2/32" treadwear or 12 months from date of purchase, whichever occurs first, will be replaced with a comparable new Dunlop tire at no charge. Mounting and balancing are included. (Without proof of purchase, date of manufacture will be used to determine age.)

TEMPORARY SPARE TIRES

Any Dunlop temporary spare tire eligible under the provisions of this limited warranty and removed from service due to a covered warranty condition during the first 50 percent of usable treadwear will be replaced with a comparable new Dunlop temporary spare tire at no charge, including mounting.

PRORATED ADJUSTMENT

A tire not eligible for no-charge replacement that is removed from service due to a covered warranty condition will be replaced with a comparable new Dunlop tire on a prorated basis.

HOW WILL PRORATED CHARGES BE CALCULATED?

Replacement price will be calculated by multiplying the tire's advertised retail selling price at the time of adjustment by the percentage of usable original tread that has been worn off. You pay for mounting, balancing and applicable taxes.

Example: If your disabled tire had an original 8/32" of usable treadwear and is worn to 4/32" usable tread remaining, you have used 50 percent and, therefore, must pay 50 percent of the current advertised selling price of the replacement tire. If the price of the new replacement tire is \$80, the cost to you would be \$40 plus any additional charges such as mounting, balancing and applicable taxes.

WHAT IS A COMPARABLE TIRE?

A comparable new Dunlop tire may either be the same line of tire or, in the event that the tire is not available, a tire of the same basic construction and quality with a different side-wall or tread configuration. If a higher priced tire is accepted as replacement, the difference in price will be at an additional charge to you.

ADDITIONAL PROVISIONS

A tire has delivered its full original treadlife and the coverage of this warranty ends when the treadwear indicators become visible (worn to 2/32"), or six (6) years from the date of original tire manufacture or new tire purchase date. (Without proof of purchase, date of manufacture will be used to determine age.)

Any replacement tire provided pursuant to this warranty will be covered by the Dunlop warranty in effect at the time of replacement.

LIMITATIONS

This limited warranty is applicable only in the United States and Canada.

WHAT IS NOT COVERED BY THIS WARRANTY?

This limited warranty does not cover the following:

- Tires submitted for ride disturbance complaints that are worn beyond the first two thirty-seconds of an inch (2/32") tread depth.
- Dunlop does not warrant or give credit in any adjustment transaction for any kind of material added to a tire (e.g., tire fillers, sealants, balancing substances) after the tire leaves a factory producing Dunlop tires, nor will it adjust any tire that has failed as a result of adding such material.
- Irregular wear or damage due to mechanical condition of the vehicle, improper inflation, overloading, high speed spin-up, misapplication, misuse, negligence, racing, use of tire chains, improper mounting or demounting, improper repair, wreck, collision or fire.
- Road hazards (includes, but not limited to, punctures, cuts, snags, impact breaks, etc.).
- Any tire that after leaving a factory producing Dunlop tires has been intentionally altered to change its appearance (e.g., white inlay on a black tire, regrooving or siping).
- Tires with weather-cracking that were purchased more than four (4) years prior to presentation for adjustment or, if purchase date cannot be verified, manufactured more than four (4) years prior to presentation for adjustment.
- Loss of time, inconvenience, loss of vehicle use, incidental or consequential damages.

(Continued on page 20)

WHAT ARE YOUR LEGAL RIGHTS?

Some states and provinces do not allow the exclusion or limitation of incidental or consequential damages, so the above limitations or exclusions may not apply to you. No representative or dealer has authority to make any representation, promise, or agreement on behalf of Goodyear Dunlop Tires North America, Ltd. (GDTNA), except as stated herein.

Any tire, no matter how well constructed, may fail in service or otherwise become unserviceable due to conditions beyond the control of the manufacturer. Under no circumstances is this warranty a representation that a tire failure cannot occur.

This warranty gives you specific legal rights, and you may also have other rights that vary from state to state and in Canada province to province.

HOW DO YOU OBTAIN AN ADJUSTMENT?

- A. You must present the tire to be adjusted to an authorized Dunlop service facility. Tires replaced on an adjustment basis become the property of Goodyear Dunlop Tires North America, Ltd. or Goodyear Canada Inc.
- B. You must pay for taxes and any additional services you order at the time of adjustment.
- C. You must submit your claim on a GDTNA claim form supplied by an authorized Dunlop service facility. The form must be filled out completely and signed by you, the owner of the tire presented for adjustment, or your authorized agent.

TIRE CARE AND MAINTENANCE GUIDE

The easiest way to help ensure satisfactory mileage and performance from your Dunlop tires is to give them a simple but frequent inspection for proper inflation, even treadwear, and the presence of any damage.

DO MAINTAIN PROPER INFLATION PRESSURE IN YOUR TIRES

Proper inflation pressure is necessary for optimum tire performance, safety and fuel economy. To maintain proper inflation pressure, frequently check tires (when they are cool) with an accurate tire pressure gauge.*

For example, it is difficult to tell just by looking at radial tires whether they are underinflated.

Furthermore, when operating a vehicle equipped with radial tires, it is difficult to notice when a tire has gone flat or nearly flat since the "feel" of the vehicle does not change significantly.

***Evidence of air loss or repeated underinflation always requires expert inspection to determine the source of leakage and tire removal to determine repairability.** To avoid injury, **NEVER** attempt to reinflate a tire that has been run severely underinflated.

Progressive air loss may result from punctures, cuts, curbing, impacts or partial bead unseating. Some fitment causes for air loss are (1) incomplete bead seating, (2) bead tearing caused by a machine tool due to insufficient lubrication or improper adjustment, (3) leaking valve core or rubber valve components. These should be replaced when problems are detected and whenever tires are replaced.

Always maintain inflation pressure at the level recommended by the vehicle manufacturer as shown on the vehicle placard or in the owner's manual:

Underinflation is the leading cause of tire failure and may result in severe cracking, component separation or "blowout." It reduces tire load capacity, allows excessive sidewall flexing and increases rolling resistance, resulting in heat and mechanical damage. Maintaining proper inflation pressure is the single most important thing you can do to ensure tire durability and maximum treadlife.

Overinflation increases stiffness, which may deteriorate ride and generate unwanted vibration. Overinflation also increases the chances of impact damage.

DON'T OVERLOAD YOUR VEHICLE

Check your vehicle owner's manual to determine the load limits. Overloading your vehicle places stress on your tires and other critical vehicle components. Overloading a vehicle can cause poor handling, increased fuel consumption and may cause tire failure.

Never fit your vehicle with new tires that have less load capacity than shown on the vehicle tire placard and remember that optimum rim width is important for proper tire load distribution and function.

The maximum load capacity stamped on the sidewalls of P-Metric tires is reduced by 10 percent when used on a light truck, utility vehicle or trailer. Never fit P-Metric tires to light trucks that specify LT-type replacement tires.

DON'T SPIN YOUR TIRES EXCESSIVELY

Avoid excessive tire spinning when your vehicle is stuck in snow, ice, mud or sand. The centrifugal forces generated by a free-spinning tire/wheel assembly may cause sudden tire explosion resulting in vehicle damage and/or serious

(Continued on page 21)

personal injury to you or a bystander. Never exceed 35 mph/60 km/h as indicated on your speedometer. Use a gentle backward and forward rocking motion to free your vehicle for continued driving. Never stand near or behind a tire spinning at high speed as, for example, while attempting to push a vehicle that is stuck or when an on-the-car spin balance machine is in use.

DO CHECK YOUR TIRES FOR WEAR

Always remove tires from service when they reach two thirty-seconds of an inch (2/32") remaining tread depth. All new tires have treadwear indicators which appear as smooth banks in the tread grooves when they wear to the two thirty-seconds of an inch (2/32") level. Many wet weather accidents result from skidding on bald or nearly bald tires. Excessively worn tires are also more susceptible to penetrations.

SIDEWALL TREATMENTS

Dunlop sidewalls are specially compounded to resist ozone cracking or weather-cracking.

Use a mild soap solution to clean sidewalls, white striping or lettering, and rinse off with plain water. Instruct service personnel and customers never to apply any other material to enhance sidewall appearance. These may degrade rubber and remove inherent ozone resistance.

DO CHECK YOUR TIRES FOR DAMAGE

Frequent inspection of your tires for signs of damage and their general condition is important for safety. If you have any questions, have your tire dealer inspect them. Impacts, penetrations, cracks, knots, bulges, or air loss always require tire removal and expert inspection. Never perform a temporary repair or use an innertube as a substitute for a proper repair. Only qualified persons should repair tires.

PROPER TIRE REPAIR

NOTE: Dunlop does not warrant any inspection or repair process. The repair is entirely the responsibility of the repairer and should be made in accordance with established Rubber Manufacturers Association (RMA) procedures.

DON'T ATTEMPT TO MOUNT YOUR OWN TIRES

Serious injury may result from explosion of tire/rim assembly due to improper mounting procedures. Follow tire manufacturer's instructions and match tire diameter to rim surfaces. Lock assembly on mounting machine or place in safety cage. **STAND BACK** and never exceed 40 psi to seat beads. Never use a volatile substance or a rubber "donut" (also known as a bead expander or "O-Ring") to aid bead seating. Only specially trained persons should mount tires.

DON'T MIX TIRES OF DIFFERENT SIZES AND TYPES ON THE SAME AXLE

For optimum handling and control, Dunlop recommends fitment of four (4) tires of the same type and size unless otherwise specified by the vehicle manufacturer.

FOLLOW THESE ADDITIONAL GUIDELINES:

Fit newest tires on rear axle. If radials and non-radials must be fitted to the same vehicle, fit radials on rear axle. Never mix radials and non-radials on the same axle. When fitting snow tires or all-season tires to performance vehicles, always fit in sets for four. Do not fit tires with different speed ratings. Use of lift kits with some vehicle/tire combinations can cause instability. When changing tire sizes, always consult dealer for optimum rim width and carefully check vehicle/tire clearances.

RETREADED TIRES

Retreaded passenger and light truck tires are not warranted by Dunlop for any reason. Dunlop speed ratings and U.S. Department of Transportation test compliance certifications are voided for retreaded tires.

DO MAINTAIN VEHICLE SUSPENSION, WHEEL ALIGNMENT AND BALANCE AND ROTATE YOUR TIRES

Lack of rotation, worn suspension parts, underinflation/overinflation, wheel imbalance, and misalignment can cause vibration or irregular tire wear. Rotate your tires according to your vehicle manufacturer's recommendations or at maximum intervals of 6,000 miles/10,000 km.

LIGHTWEIGHT TEMPORARY SPARE TIRES IMPORTANT SAFETY INSTRUCTIONS

- Limit vehicle speed when using the lightweight temporary spare tire to 50 mph/80 km/h or less.
- Check the inflation pressure before using and at least weekly. Maintain cold tire pressure in accordance with that molded on the tire sidewall or found in your vehicle owner's manual. When inflating or adding air to lightweight temporary spare tire, be very careful, since the smaller tire volume can gain pressure quickly. Leave valve core in place and add inflation air in short bursts. Check the pressure often with an in-line or hand gauge until the specified pressure is reached.
- The lightweight temporary spare tire may lower ground clearance when used. Reduce speed and avoid driving over large obstacles or through chuckholes and other road hazards.
- Check your car owner's manual for other special clearance precautions when using the lightweight

(Continued on page 22)

temporary spare tire provided in your vehicle.

- Because your lightweight temporary spare tire was specifically designed for your car, it should not be used on any other vehicle.
- Do not use snow chains on your lightweight temporary spare tire. This could cause damage to your vehicle.
- Your lightweight temporary spare has very limited wear potential (up to 300 miles/500 km).
- In order to conserve tire treadlife, the lightweight temporary spare tire should be returned to your trunk as soon as the standard tire has been repaired or replaced. Never use the spare if treadwear indicator (TWI) bars are exposed or it is worn to the last 2/32" tread depth.
- Do not use your original equipment lightweight temporary spare tire on any other than its original equipment rim. The replacement lightweight temporary spare tire must match the original equipment tire removed from your lightweight temporary spare rim. Check the tire for the lightweight temporary spare tire size marking designation and compare size markings with those found on both your original lightweight temporary spare and rim.

NOTE: Your original equipment lightweight temporary spare tire and rim combination is not the same size as the other tires and rims with which your vehicle is equipped. Standard tires, snow tires, conventional wheel covers or rim rings should not be fitted to your lightweight temporary spare tire rim or assembly.

- Improper mounting can cause tire/rim assembly explosion and serious injury. Tire Fitters: Follow tire manufacturer's instructions and match tire diameter to rim diameter. Mount the lightweight temporary spare tire only on a rim originally fitted with a temporary spare of the same size. Lubricate beads and rim contact surfaces. Lock assembly on mounting machine or place in a safety cage. **STAND BACK;** inflate in short

bursts with extension hose, clip-on chuck on in-line gauge. Never exceed 40 psi to seat beads or use a volatile substance or a rubber "donut" to aid bead seating. Only specially trained persons should mount lightweight temporary spare tires.

Dunlop brand tires are serviced by The Goodyear Tire & Rubber Company and Goodyear Canada Inc. through authorized Dunlop outlets.

You must go to an authorized Dunlop outlet for replacement tires and all warranty service.

THE WARRANTOR

The warrantor of Dunlop tires is Goodyear/Dunlop N.A. Limited at 1144 East Market Street, Akron, Ohio 44136-0001

FOR SERVICE ASSISTANCE OR INFORMATION:

- FIRST CONTACT THE NEAREST DUNLOP RETAILER.
- IF ADDITIONAL ASSISTANCE IS REQUIRED:
IN THE UNITED STATES:
Call (800) 321-2136, or write:
Goodyear/Dunlop Consumer Relations
Dept. 728
1144 East Market Street, Akron, OH 44316-0001
IN CANADA:
Call (800) 387-3288, or write:
Goodyear/Dunlop Consumer Relations Department
450 Kipling Avenue
Toronto, Ontario M8Z 5E1

SAFETY WARNINGS

Serious injury or property damage may result from:

- **TIRE FAILURE DUE TO UNDERINFLATION/OVERLOADING:**
Follow the owner's manual, tire placard in vehicle, or Important Tire Safety Information located in this booklet.
- **EXPLOSION OF TIRE/RIM ASSEMBLY DUE TO IMPROPER MOUNTING:**
Only specially trained persons should mount tires.
- **FAILURE TO MOUNT RADIAL TIRES ON APPROVED RIMS.**
- **FAILURE TO DEFLATE SINGLE OR DUAL ASSEMBLIES COMPLETELY BEFORE DEMOUNTING.**
- **TIRE SPINNING ON SLIPPERY SURFACES SUCH AS SNOW, MUD, ICE, ETC. DO NOT SPIN TIRES IN EXCESS OF 35 MPH (55 KPH), AS INDICATED ON THE SPEEDOMETER. PERSONAL INJURY AND SEVERE DAMAGE MAY RESULT FROM EXCESSIVE WHEEL SPINNING, INCLUDING TIRE DISINTEGRATION OR AXLE FAILURE.**

GENERAL TIRE LIMITED WARRANTY AND ADJUSTMENT POLICY

This Limited Warranty and Adjustment (the "Policy") is issued by Continental Tire North America, Inc. (the "Company") and is applicable for General-brand original equipment tires and is a promise of replacement under certain specified conditions. This Policy applies to tires in normal service displaying adjustable conditions (see Section 4) and does not require the existence of a workmanship or material related condition in order to qualify for adjustment. THIS POLICY IS NOT A WARRANTY THAT YOUR TIRE WILL NOT FAIL OR BECOME UNSERVICEABLE IF NEGLECTED OR MISTREATED.

1. ELIGIBILITY

- This Policy applies to the owner of Passenger Car, Light Truck and Serva-Spare tires bearing the General brand name and serial numbers, and operated in normal service.
- Eligible tires must be the original equipment tires, used on the vehicle on which they were originally installed by the vehicle manufacturer.
- Tires branded "used" are not eligible under this Policy.

2. WHAT IS THE ADJUSTMENT POLICY AND FOR HOW LONG?

Limited warranty coverage is for a maximum period of 72 months from the date of purchase*, determined by the new vehicle registration date or new vehicle sales invoice showing date of purchase.

If an eligible Passenger or Light Truck or Serva-Spare tire, used in normal service, becomes unserviceable from a condition other than those listed under Section 4, during or after the time or treadwear periods shown below, it will be replaced with a comparable** new General brand tire according to (A) and (B) below.

(A) Free Replacement Policy:

| | <u>Time*</u> | <u>Treadwear</u> |
|------------------------------|---|------------------|
| Passenger Tire | First 12 Months or First 2/32nds, (whichever comes first). Mounting & balancing included free of charge. Owner pays all applicable taxes. | |
| Light Truck Tire | First 12 Months or First 3/32nds, (whichever comes first). Mounting & balancing included free of charge. Owner pays all applicable taxes. (Excluding F.E.T.) | |
| Serva-Spare Tires | No Time Limit First 1/32nd Mounting & balancing included free of charge. Owner pays all applicable taxes. | |

(B) Pro Rata Replacement Policy:

Passenger/Light Truck Tires

After the "Free Replacement Policy" expires (set forth in section 2A), and the tire is still within 72 months from the date of purchase*, you will pay, on a pro rata basis, for a comparable** new General brand replacement tire. A tire is eligible for an adjustment on a pro rata basis until the tread is worn down to the tread wear indicators (2/32nds of an inch of tread remaining). The tire tread is worn out at this point and this Policy ends regardless of time period. Owner pays all applicable taxes (including F.E.T.), mounting and balancing charges.

Serva-Spare Tires

After the "Free Replacement Policy" expires (set forth in section 2A), no adjustment will be made.

* At the time of claim, you need to present your new vehicle registration or new vehicle sales invoice showing date of purchase. If satisfactory proof-of-purchase date is not provided, the D.O.T. certification date of manufacture (tire serial number) will be used.

** A "comparable" new General brand tire may be either the same tire line or the same basic construction but with a different sidewall or tread configuration. If a higher-priced tire is accepted as replacement, the owner will pay the difference in price. Any tire replaced under this Policy will be covered by the current General Tire Limited Warranty and Adjustment Policy

3. HOW A PRO RATA PRICE IS CALCULATED

The replacement tire price will be determined by multiplying the percentage of the usable tread worn by the Dealers Selling Price (excluding all applicable taxes) at the time of the adjustment or the General brand current published Adjustment Base Price, whichever is lower. The usable tread is the original tread down to the tread wear indicators (2/32nds of an inch of tread remaining). The Adjustment Base Price is intended to fairly represent a Dealer's Selling Price for the same or comparable tire.

(Continued on page 24)

4. WHAT IS NOT COVERED BY THE ADJUSTMENT POLICY

a. The following conditions are not covered:

Road Hazard: Cuts, snags, punctures, bruises or impact breaks and any damage caused by puncture or tire repair.

Ride/Vibration: After "Free Replacement Policy" (set forth in section 2A) expires.

Tire Damage or Failure Resulting From Improper Operation or Maintenance: Load, speed, and inflation practices causing excessive operational temperatures to exceed the tire capabilities.

Tire damage (including irregular treadwear) or failure resulting from: improper mounting or demounting, damaged rim, wheel alignment, tire trueing, chain damage, brakes or any similar mechanical problem, extreme temperature exposure, misuse, negligence, and abusive driving such as tire spinning, racing or accident damage.

Tire failure resulting from intentional alterations: such as adding a white inlay on a blackwall or sealant materials.

Age Conditions: Weather checking/cracking coverage is for a maximum period of 48 months from the date of purchase.

b. General Exclusions -

Tire(s) submitted for an adjustment in service for longer than 72 months from date of purchase*, are not covered by this policy.

Tire(s) on any vehicle registered and normally operated outside the United States and Canada are not covered under this Policy. For tires on vehicles normally operated outside the United States and Canada, see the nearest General Tire dealer or distributor for local coverage.

Tire(s) transferred from the vehicle on which they were originally installed are not covered under this Policy.

Company does not offer tread wearout coverage up to a predetermined mileage under this Policy.

Tire(s) used in racing related activities or competitive events are not covered by this Policy.

THIS LIMITED WARRANTY IS IN LIEU OF ALL OTHER WARRANTIES, EXPRESS OR IMPLIED, INCLUDING, BUT NOT LIMITED TO, WARRANTIES OF MERCHANTABILITY OR FITNESS FOR A PARTICULAR PURPOSE. NO OTHER WARRANTIES, EXPRESS OR IMPLIED, INCLUDING, BUT NOT LIMITED TO, WARRANTIES OF MERCHANTABILITY OR FITNESS FOR A PARTICULAR PURPOSE, ARE MADE OR INTENDED BY COMPANY. COMPANY DISCLAIMS ALL IMPLIED WARRANTIES, INCLUDING WARRANTIES OF MERCHANTABILITY OR FITNESS FOR A PARTICULAR PURPOSE. ANY IMPLIED WARRANTIES, INCLUDING, BUT NOT LIMITED TO, ANY WARRANTY OF MERCHANTABILITY OR FITNESS FOR A PARTICULAR PURPOSE, ARE LIMITED IN DURATION TO THE DURATION OF THIS WRITTEN WARRANTY. SOME STATES DO NOT ALLOW LIMITATIONS ON HOW LONG AN IMPLIED WARRANTY LASTS, SO THE ABOVE LIMITATION MAY NOT APPLY TO YOU.

NO COMPANY EMPLOYEE, RETAILER OR DEALER HAS THE AUTHORITY TO MAKE ANY WARRANTY, REPRESENTATION, PROMISE OR AGREEMENT ON BEHALF OF COMPANY EXCEPT AS STATED IN THIS LIMITED WARRANTY.

TO THE EXTENT PERMITTED BY LAW, COMPANY DISCLAIMS LIABILITY FOR ALL CONSEQUENTIAL AND INCIDENTAL DAMAGES. THE REMEDIES SET FORTH IN THIS LIMITED WARRANTY ARE THE SOLE AND

EXCLUSIVE REMEDIES FOR BREACH OF WARRANTY. SOME STATES DO NOT ALLOW THE EXCLUSION OR LIMITATION OF INCIDENTAL OR CONSEQUENTIAL DAMAGES SO THE ABOVE LIMITATIONS OR EXCLUSION MAY NOT APPLY TO YOU. THIS WARRANTY GIVES YOU SPECIFIC LEGAL RIGHTS, AND YOU MAY ALSO HAVE OTHER RIGHTS WHICH MAY VARY FROM STATE TO STATE.

5. COMPANY'S OBLIGATIONS

Any replacement qualifying under this Adjustment Policy will be made by any General brand authorized dealer or vehicle dealer authorized to handle General brand tire adjustments. Company will replace the tire pursuant to the terms of this Adjustment Policy.

6. OWNER'S OBLIGATIONS

To make a claim under this Policy concerning any tire which is covered by this Policy, you must present your claim with the tire to any General brand tire dealer or vehicle dealer authorized to handle General brand tires. For the nearest General brand tire dealer, check the Yellow Pages, or use the General brand Internet address, or one of the "800" numbers shown under "For Customer Assistance." To be eligible for the terms of this Policy, you need to present your new vehicle registration form or new vehicle sales invoice showing date of purchase. Tires replaced on an adjustment basis become the property of Company. You will be required to sign the Company Limited Warranty Claim Form or dealer replacement sales receipt.

You are responsible for payment of all applicable taxes demounting, mounting and balancing charges set forth under this Policy. You are also responsible for payment of local tire-disposal fees and any parts or service regardless of mileage or months of service. This includes payment for tire rotation, alignment, towing, road service, valve stems and tire repairs.

(Continued on page 25)

Owner is responsible for maintaining proper tire air pressure and for proper maintenance of the tire.

THE WARRANTOR

The warrantor of General brand tires is Continental Tire North America, Inc., 1800 Continental Blvd., Charlotte, NC 28273.

For Customer Assistance:

1-800-847-3349 (Nationwide)

1-800-461-1776 (In Canada)

<http://www.generaltire.com>

SAFETY WARNING

Disregarding any of the safety precautions and instructions contained in the Owner's Manual or the Important Tire Safety Information in this booklet may result in tire failure or explosion causing serious personal injury or death.

ELIGIBILITY

You are eligible for the benefits of this policy if you are the owner or authorized agent of the owner of new Goodyear highway auto and light truck tires bearing Department of Transportation prescribed tire identification numbers, and if your tires have been used only on the vehicle on which they were originally installed according to the vehicle manufacturer's recommendations.

COVERAGE (REPLACEMENT FREE)

Any new Goodyear highway radial auto tire or radial light truck tire, except Unisteel radial light truck tires, covered by this policy, that does not deliver satisfactory highway service due to a workmanship or material related condition (see Adjustment Policy Limitations) during the first 25% of usable treadwear, or twelve months from date of purchase, whichever comes first, will be replaced with a comparable new Goodyear tire without charge. Mounting and balancing are included.

Any Goodyear temporary spare tire that does not deliver satisfactory highway service due to a workmanship or material related condition during the first 50% of usable tread depth (1/32 of an inch) will be replaced with a comparable new Goodyear temporary spare tire without charge. Mounting is included. After the first 50% of usable treadwear, you pay only an adjustment charge for the treadwear received, plus any mounting charge.

COVERAGE (PRORATED ADJUSTMENT)

Tires not eligible for no charge adjustment that do not deliver satisfactory service due to a workmanship or material related condition will be replaced with comparable new Goodyear tires on a pro rata basis. The replacement price will be calculated by multiplying the current Goodyear "predetermined price for adjustment" or current advertised price at adjustment location (whichever is lower) by the percentage of usable original tread that has been worn off at the time of the adjustment. You pay for mounting, balancing, and an amount equal to the full current Federal Excise Tax applicable to the comparable new replacement tire.

The "predetermined price for adjustment," available at all Goodyear Auto Service Centers and participating dealers, fairly represents the actual regular retail selling price of the comparable tire at the time of adjustment. If a "predetermined price for adjustment" is not available, adjustment will be based on the price at which you are entitled to buy at the time of adjustment.

A tire has delivered its full original tread life and this warranty ends when the treadwear indicators become visible, regardless of age or mileage.

DEFINITION OF COMPARABLE TIRE

A "comparable" new Goodyear tire may either be the same line of tire or, in the event the disabled tire is out of production, the same basic construction and quality with different sidewall or tread configuration.

If a higher priced tire is accepted as replacement, the difference in price will be additional.

Any tire replacement under this warranty will be covered by the Goodyear warranty in effect at time of replacement.

ADJUSTMENT POLICY LIMITATIONS

This limited warranty is applicable only in the United States and Canada.

No representative or dealer has authority to make any representation, promise, or agreement on behalf of Goodyear, except as stated herein.

The following are not covered by this policy:

- Goodyear does not warrant and will not give credit in any adjustment transaction for any kind of material added to the tire after leaving a Goodyear factory, nor will it adjust any tire which has failed as a result of adding any such material. (Example: Tire fillers, sealants, or balancing substances.)

- Irregular wear or tire damage due to:
 - Road hazards (including punctures, cuts, snags, impact breaks, etc.).
 - Wreck, collision, or fire.
 - Improper inflation, overloading, high speed spinup, mis-application, misuse, negligence, racing, chain damage or improper mounting or demounting.
 - Mechanical condition of the vehicle.
 - Ride disturbance after the first 25% of usable treadwear or due to damaged wheels or any vehicle condition.
 - Temporary spare tires used on vehicle used in racing and on passenger cars in special applications, such as police pursuit service.
 - Any tire intentionally altered after leaving a Goodyear factory to change its appearance. (Example: White inlay on a black tire.)
 - Tires with weather cracking which were purchased more than four (4) years prior to presentation for adjustment. If you have no proof of purchase date, tires manufactured four (4) or more years prior to presentation are not covered.
- Loss of time, inconvenience, loss of use of the vehicle or consequential damage.

Some states do not allow the exclusion or limitation of incidental or consequential damages so the above limitations or exclusion may not apply to you.

Any tire, no matter how well constructed, may fail in service or otherwise become unserviceable due to conditions beyond the control of the manufacturer. This warranty is not intended as a representation that a tire failure cannot occur.

OWNER'S OBLIGATIONS

- a. You must present the tire to be adjusted to a Goodyear Auto Service Center or Goodyear Tire Dealer. (Please consult your telephone directory for locations.) Tires replaced on an adjustment basis become the property of The Goodyear Tire & Rubber Company.
- b. You must pay for taxes or any additional service you order at the time of adjustment.
- c. No claim will be recognized unless submitted on a Goodyear claim form (supplied by Goodyear dealer or Auto Service Center) completely filled out and signed by you, the owner of the tire presented for adjustment, or your authorized agent.

LEGAL RIGHTS

This warranty gives you specific legal rights, and you may also have other rights which vary from state to state.

THE WARRANTOR

The warrantor of Goodyear tires is The Goodyear Tire & Rubber Company, 1144 E. Market Street, Akron, Ohio 44316.

For Customer Assistance:
1-800-321-2136 (Nationwide)

SAFETY WARNING

Follow safety precautions and instructions contained in the Owner's Manual, tire placard in the vehicle or the Important Tire Safety Information in this booklet. Disregarding tire safety information may result in tire failure or explosion causing serious personal injury or death.

WHO IS COVERED

The owner of a Michelin Passenger or Light Truck tire which bears the Michelin name and complete DOT identification number.

WHAT IS COVERED AND FOR HOW LONG

Michelin Passenger and Light Truck tires, used in normal service on the vehicle on which they were originally fitted and in accordance with the maintenance recommendations and safety warnings contained in the owner's manual and in the Important Tire Safety Information Section of this booklet, are covered by this warranty against defects in workmanship and material for the life of the original usable tread, or 6 years from the date of purchase, whichever comes first. At that time, all warranties, express or implied, are terminated. The usable tread is the original tread down to the level of the tread wear indicators - 2/32nds of an inch (1.6mm) of tread remaining. Date of purchase is documented by new vehicle registration or tire sales invoice. If no proof of purchase, coverage will be based on date of manufacture.

WHAT IS NOT COVERED

Tires which become unserviceable due to:

- Road hazard injury (e.g., a cut, snag, bruise, impact damage, puncture, whether repairable or not);
- Incorrect mounting of the tire, tire/wheel imbalance, or improper repair;
- Underinflation, overinflation, improper maintenance or other abuse;
- Mechanical irregularity in the vehicle such as wheel misalignment resulting in uneven or rapid wear;
- Accident, fire, chemical corrosion, tire alteration, or vandalism;
- Ozone or weather cracking.

WHAT MICHELIN WILL DO**PASSENGER AND LIGHT TRUCK TIRES**

A tire which becomes unserviceable due to a condition covered by this warranty will be replaced with a comparable new Michelin tire, free of charge, when 2/32nds of an inch (1.6mm) or less of the original tread is worn, (or 25% or less, whichever is most beneficial to the user) and within 12 months of the date of purchase. Mounting and balancing of tires is included. The cost of any other service charges or applicable taxes are payable by the user.

When more than 2/32nds of an inch of original tread has been worn (or more than 25%, whichever is most beneficial to the user) or after 12 months from date of purchase, the user must pay the cost of a comparable new Michelin passenger or light truck replacement tire on a pro-rata basis. The dealer shall determine the charge by multiplying the percentage of the original usable tread worn by the current actual selling price at the adjustment location or the price on the current Michelin Base Price List, whichever is lower. This List is based on a predetermined price intended to fairly represent the actual selling price of the tire. The cost of mounting, balancing and any other service charges or applicable taxes are payable by the user.

(Continued on page 29)

WHAT THE CONSUMER MUST DO

When making a claim under the terms of this warranty, the consumer must present the tire to an authorized Michelin Dealer. To locate an Authorized Tire Dealer, check the yellow pages under "Tire Dealers - Retail."

The vehicle on which the tire was used should be available for inspection.

It is essential that you read and understand the safety and maintenance recommendations (see Safety Maintenance Information) for your tires.

CONDITIONS AND EXCLUSIONS

THIS WARRANTY DOES NOT PROVIDE COMPENSATION FOR LOSS OF TIME, LOSS OF USE OF VEHICLE, INCONVENIENCE OR CONSEQUENTIAL DAMAGE.

TIRES PRESENTED FOR CLAIM REMAIN THE PROPERTY OF THE CONSUMER AND MICHELIN ACCEPTS NO RESPONSIBILITY FOR LOSS OF, OR DAMAGE TO, TIRES WHICH ARE IN THE CUSTODY OR CONTROL OF A MICHELIN TIRE DEALER FOR THE PURPOSES OF INSPECTION FOR WARRANTY ADJUSTMENT. IN THE EVENT OF A DISPUTED CLAIM, THE CONSUMER MUST MAKE THE TIRE AVAILABLE FOR FURTHER INSPECTION.

NO MICHELIN REPRESENTATIVE, EMPLOYEE OR DEALER HAS THE AUTHORITY TO MAKE OR IMPLY ANY REPRESENTATION, PROMISE OR AGREEMENT, WHICH IN ANY WAY VARIES THE TERMS OF THIS WARRANTY.

THIS WARRANTY APPLIES ONLY IN THE UNITED STATES AND CANADA.

CONSUMER RIGHTS

THIS WARRANTY GIVES YOU SPECIFIC LEGAL RIGHTS, AND YOU MAY ALSO HAVE OTHER RIGHTS WHICH VARY FROM STATE TO STATE AND PROVINCE TO PROVINCE.

SAFETY MAINTENANCE INFORMATION

Read your vehicle owners manual, the information on the sidewall of your tires, the vehicle tire information placard and the Important Tire Safety Information section of this booklet for essential safety and maintenance information.

THE WARRANTOR

The warrantor of Michelin Tires is Michelin North America, Inc. 1 Parkway South, P.O. Box 19001, Greenville, South Carolina 29602-9001.

For Customer Assistance:

1-800-TIRE HELP (800-847-3435) - U. S.

1-800-461-8473 - Canada (outside Quebec)

1-800-565-7638 - Canada (Quebec)

DANGER

Disregarding any of the safety precautions and instructions contained in the Owner's Manual or the Important Tire Safety Information in this booklet may result in tire failure or explosion causing serious personal injury or death.

PASSENGER TIRES AND LIGHT TRUCK TIRES LIMITED WARRANTY

Toyo Tire (U.S.A.) Corporation warrants Toyo brand passenger tires and light truck tires mounted on vehicles as original equipment for adjustable conditions as follows:

1. What is covered by the warranty:

Toyo brand passenger and light truck tires are warranted for adjustable conditions other than those listed under "What Is Not Covered" for the new original usable tread down to the treadwear indicators (2/32nd" tread remaining) or for 60 months from the date of manufacture, whichever comes first. The DOT serial number on the sidewall of the tire will be used to determine date of manufacture. This time limit does not apply to Toyo temporary spare tires. Presence of a manufacturing anomaly is not necessarily required to qualify for adjustment.

- (A) When less than 25% of the original usable tread of a radial tire, or less than 50% of the original usable tread of a temporary spare tire has been worn, the tire will be replaced with a new Toyo tire free of charge, including mounting and balancing. (Adjustments for ride disturbances or vibration, which cannot be corrected by balancing are only adjustable in the first 25% of usable tread.) Service charges or any applicable taxes are payable by you.
- (B) When more than 25% of the original usable tread of a radial tire, or more than 50% of the original usable tread of a temporary spare tire has been worn the user must pay for the cost of a replacement tire based on the amount of tread used. This is

calculated by dividing the number of 32nds of an inch used by the original usable tread depth and multiplying by the actual current dealer selling price. Service charges or any applicable taxes are payable by you.

2. What is not covered by the warranty:

- (A) Mileage is not warranted.
- (B) Damage due to road hazards whether repairable or not (such as cuts, snags, bruises, impact or punctures, improper tire chains).
- (C) Irregular tread wear or rapid tread wear due to failure to rotate the tires at recommended intervals, or from vehicle misalignment.
- (D) Damage resulting from improper repair materials or procedures.
- (E) Damage from incorrect mounting or dismounting of the tire, incorrect wheel size, or failure to balance the tires.
- (F) Damage or uneven tread wear from incorrect inflation, overloading, fire, theft, defective mechanical conditions such as brakes, shocks, rims, wreck or collision, and willful damage or abuse.
- (G) Damage, corrosion, or rubber deterioration due to the use of oil-based chemicals, water-based sealers, balancing substances, or flammable gases.
- (H) Ride, balance, or vibration complaints after the first 25% of tread wear.
- (I) Minor surface blemishes due to weathering and normal wear and tear which do not affect the serviceability of the tire.

- (J) Any tire which has been run to destruction while flat.
- (K) Tires used in commercial service.
- (L) Claims after 5 years from the date the tire was manufactured.
- (M) Tires on vehicles normally operated outside the United States.
- (N) Claims made by anyone other than the original retail purchaser of the vehicle.
- (O) Tires with the D.O.T. identification number removed or rendered illegible, or branded "used".
- (P) Any claim where the tire is not presented and available for Toyo's inspection.
- (Q) Any tire for which mileage and tire rotation records are not available or verifiable.
- (R) Any tires worn beyond the wear bars (less than 2/32" remaining tread).
- (S) Temporary spare tires used at speeds over 50 miles per hour.
- (T) Dealer service charges are not covered for routine or required maintenance of the tires such as alignments or rotation.

CONSUMER'S OBLIGATION

The consumer is responsible for proper tire care and maintenance:

- (1) Tires must be rotated every 7,500 miles or sooner if upon inspection, irregular or erratic tread wear is beginning to appear. Keep a record of the rotation.
- (2) The consumer must maintain the recommended

air pressure in the tires according to Nissan's recommendation.

- (3) The consumer must maintain the vehicle's alignment in accordance with Nissan's specifications.
- (4) The load capacity of the tires must not be exceeded.
- (5) The tire's maximum speed capability must not be exceeded.

TO MAKE A CLAIM UNDER THIS LIMITED WARRANTY

In the event that you make a claim under the terms of the warranty, you must:

- (1) Present your tires, and your vehicle to an authorized Toyo Dealer. (Call consumer relations at (800) 442-8696 or check dealer locator at <http://www.toyo.com> for the nearest dealer location.)
- (2) Complete and sign the Toyo Standard Claim form provided by the dealer and leave the tire with the dealer for warranty processing.

NOTE: For your convenience, your nearest authorized Nissan Dealership will also assist you with your tire service requirements or in obtaining tire warranty service from the tire manufacturer.

The consumer is entitled to an adjustment in accordance with the warranty that was in effect when the tire was installed on the vehicle as original equipment. The adjustment policy provides for replacement with a comparable new Toyo tire if a Toyo tire becomes unserviceable due to an adjustable condition verified by Toyo's inspection of the tire. Free replacement or a pro-rated charge depends

on the remaining usable tread when the tire is presented for adjustment.

EXCLUSIONS AND LIMITATIONS

This warranty is limited to the 50 United States, and the District of Columbia. All implied warranties, including warranty of merchantability or fitness for a particular purpose are expressly limited to the duration of this warranty. All obligations or liabilities for incidental or consequential damages are hereby excluded (such as loss of time, loss of use of vehicle, towing charges or road service or inconvenience). Some states do not allow limitations on how long an implied warranty lasts, or the exclusion or limitation of incidental or consequential damages, so the above limitations or exclusions may not apply to you. No Toyo employee, representative or dealer has the authority to make or imply any representation, promise or agreement which in any way varies the terms of this warranty. This warranty gives you specific legal rights and you may also have other rights which vary from state to state.

Important: In accordance with Federal Law, this warranty has been designated as a "Limited Warranty". Nothing in this warranty is intended to be a representation that tire failures cannot occur.

THE WARRANTOR

The warrantor of Toyo Tires is Toyo Tire U.S.A. Corp., 6415 Katella Ave., Suite 200, Cypress, CA 90630.

IMPORTANT SAFETY AND MAINTENANCE INFORMATION!

Any tire, no matter how well constructed, can fail as a result of punctures, impact damage, improper inflation or other conditions resulting from use. Tire failures may create a risk of property damage or personal injury. To reduce the risk of tire failure, we strongly recommend the following:

WARNING!

SERIOUS INJURY MAY RESULT FROM:

1. Tire failure due to underinflation, vehicle overloading, or use in excess of legal speeds – follow owner's manual or tire information placard in your vehicle.
2. Explosion of tire/rim assembly due to improper mounting – only specially trained persons should mount tires.

Refer to Important Tire Safety Information and instructions contained in this booklet, the tire placard in the vehicle or the Owner's Manual.

WHO IS THE WARRANTOR

The warrantor of the tires supplied as original equipment on your new Nissan vehicle is the tire manufacturer or tire distributor of your specific tires. Nissan is **NOT** the warrantor of your original equipment tires. The warrantor for each of the tire brands which may be installed as original equipment on your new Nissan is listed below.

■ **BFGoodrich Tires**

P.O. Box 19026
Greenville, South Carolina 29602-9026
1-877-788-8899

■ **Bridgestone and Firestone Tires**

Bridgestone/Firestone, Inc.
Attn: Technical Services
One Bridgestone Park
Nashville, Tennessee 37214
1-800-TIREBSA (1-800-847-3272)

■ **Continental General Tire, Inc.**

1800 Continental Blvd.
Charlotte, North Carolina 28273
1-800-847-3349
1-800-461-1776 (In Canada)
<http://www.contigentire.com>

■ **Goodyear Tire & Rubber Company (Goodyear and Dunlop Tires)**

1144 E. Market Street
Akron, Ohio 44316
1-800-321-2136

■ **Michelin North America, Inc.**

1 Parkway South
P.O. Box 19001
Greenville, South Carolina 29602-9001
1-800-TIRE HELP
(1-800-847-3435) - U. S.
1-800-461-8473 - Canada (outside Quebec)
1-800-565-7638 - Canada (Quebec)

■ **Toyo (U.S.A.) Corporation**

6415 Katella Ave., Suite 200
Cypress, California 90630
1-800-442-8696
<http://www.toyo.com>

WHAT IS COVERED

The tire manufacturer's warranty for the specific tires supplied as original equipment on your vehicle may be found on the preceeding pages.

Please refer to the following pages for important safety information.

WHAT YOU MUST DO

To obtain information on tire warranties and tire dealer service locations or for customer service, contact the appropriate warrantor listed above.

In order to obtain warranty service, you must present the unserviceable tire to an authorized Nissan dealer or to an authorized dealer of the warrantor in the United States or Canada. Their names and addresses are listed in your local telephone directory. Your Nissan dealer will also assist you with your tire service requirements or in obtaining tire warranty service from the tire manufacturer.

Any tire, no matter how well constructed, may fail due to improper maintenance or service factors. This could create a risk of property damage and serious or fatal injury. Disregarding any of the safety precautions and instructions contained in this manual may result in tire failure or explosion causing serious personal injury or death. For your safety, comply with the following:

TIRE INFLATION

Keep tires inflated to the pressures recommended on the tire data placard. (See your OWNER'S MANUAL for location.) These inflation pressures must be maintained as a minimum. However, do not exceed the maximum pressure rating indicated on the tire sidewall.

CHECK INFLATION PRESSURES ON ALL YOUR TIRES, INCLUDING THE SPARE, WHEN TIRES ARE COLD, AT LEAST ONCE A MONTH BEFORE DRIVING.

Failure to maintain correct inflation may result in improper vehicle handling and may cause rapid and irregular tire wear, sudden tire destruction, loss of vehicle control and serious personal injury. Therefore, inflation pressures should be checked at least once a month and always prior to long distance trips.

Pressures should be checked when tires are cold. The tires are cold when your vehicle has been driven less than a mile at moderate speed after being stopped for three or more hours.

CHECKING PRESSURE WHEN TIRES ARE HOT

If you must add air when your tires are hot, add four pounds per square inch (psi) (28kPa) above the recommended cold air pressure. Recheck the inflation pressure when the tire is cold.

For Example Only:

Gauge reading of hot tire: 32psi

If recommended pressure is: 30psi

Desired gauge reading of hot tire $30 + 4\text{psi} = 34\text{psi}$

Check cold pressures as soon as possible, at least by the next day. Never "bleed" air from hot tires as your tire will be underinflated. Use an accurate tire gauge to check pressures. Never allow children to air up tires.

DRIVING ON ANY TIRE THAT DOES NOT HAVE THE CORRECT INFLATION PRESSURE IS DANGEROUS.

For replacement tires, the correct inflation pressure will be provided by your tire dealer, if not, refer to the vehicle decal.

Underinflation produces extreme flexing of the sidewalls and builds up heat which may result in sudden tire destruction and serious personal injury. Overinflation can cause the tire to be more susceptible to impact damage.

LOAD LIMITS

DONOT OVERLOAD. DRIVING ON ANY OVERLOADED TIRE IS DANGEROUS. Never load your tires beyond the load carrying limits molded into the sidewall of the tires or the maximum vehicle load limit as shown on the vehicle tire data placard, whichever is less. Overloading causes heat to build up which can lead to sudden tire failure and

serious personal injury.

SPEED LIMITS AND SPEED RATED TIRES

HIGH SPEED DRIVING CAN BE DANGEROUS.

Never operate your vehicle in excess of lawful speeds or the maximum speeds justified by the driving conditions. Excessive speeds or racing can cause heat buildup in a tire leading to possible failure and serious personal injury.

Correct inflation pressure is especially important.

However, at high speeds, even with the correct inflation pressure, a road hazard, for example, is more difficult to avoid and if contact is made, there is a greater chance of causing tire damage than at the lower speed. Moreover, driving at high speed reduces the reaction time available to avoid accidents and bring your vehicle to a safe stop. If you see any damage to a tire or wheel, replace it with your spare tire and see your tire dealer at once.

Tire speed ratings do not imply that a vehicle can be safely driven at the maximum speed for which the tire is rated. In addition, some damages or improper repairs may cause a speed-rated tire to lose its speed rating. Exceeding the tire's maximum speed rating will cause the tire to build up excessive heat which can cause tire damage that could result in sudden tire destruction and rapid air loss. Failure to control a vehicle with sudden air loss can lead to an accident. In any case, you should not exceed reasonable speeds as indicated by the legal limits and driving conditions.

(Continued on page 34)

* Provided by and published at the request of the tire manufacturers/warrantors.

SPEED SYMBOLS - are shown on the sidewall of some tires. The following table shows the maximum speed corresponding to the symbol.

SPEED RATINGS

| †Speed Rating | Speed mph | Maximum km/Hr |
|---------------|-----------|---------------|
| M | 81 | 130 |
| N | 87 | 140 |
| P | 93 | 150 |
| Q | 99 | 160 |
| R | 106 | 170 |
| S | 112 | 180 |
| T | 118 | 190 |
| H | 130 | 210 |
| V* | 149 | 240 |
| Z** | 149 | 240 |

***Some V (or VR) rated tires may have a speed capacity of greater than 149 mph (240 km/h).** Consult your tire manufacturer for maximum speed ratings if your vehicle capability exceeds this speed.

****Z (or ZR) rated tires are designed for use on cars with maximum speed capabilities in excess of 149 mph (240 km/h).** Consult your tire manufacturer for maximum speed capabilities.

†Although a tire may be speed rated, we do not endorse the operation of any vehicle in an unsafe or unlawful manner.

Speed ratings are based on laboratory tests which relate to performance on the road, but are not applicable if tires are underinflated, overloaded, worn out, damaged, altered, improperly repaired, or retreaded. Furthermore, tire speed ratings do not imply that vehicles can be safely driven at the maximum speed for which the tire is rated, particularly under adverse road and weather conditions or if the vehicle has unusual characteristics. Most highway passenger tires that do not have a speed symbol in the sidewall have a maximum speed rating of 105 mph. Light truck highway tires that do not have a speed symbol on the sidewall of the tire have a maximum speed of 87 mph. Some light truck tires may have higher maximum speeds; consult your tire dealer. The speed and other ratings of retreaded tires are assigned by the retreader and voids the original manufacturer's ratings.

IMPORTANT: *In order to maintain the speed capability of the vehicle, replacement tires must have speed ratings equal to or higher than those fitted as original equipment (as indicated on the vehicle placard or owners manual). If tires with lower speed ratings are fitted, the speed capability of the vehicle will be lowered to the maximum speed capability of the replacement tire as indicated on the above table.*

Remember...High speed driving can be dangerous and may be damaging to your tires. And...When driving at highway speeds, correct inflation pressure is especially important.

Contact the manufacturer of your tires for their position and assistance on the repair of speed-rated tires. When you are replacing tires that have a speed rating, you must replace with tires of the same or higher speed rating if the speed capability of the vehicle is to be maintained.

VISUAL INSPECTION

INSPECT YOUR TIRES. DO NOT DRIVE ON A DAMAGED TIRE OR WHEEL. Check your tires frequently for scrapes, bulges, separations, cuts, snags, cracks, penetrations or excessive localized wear from hard braking. Also check for abnormal tire wear, particularly on the edges of the tire tread which may be caused by misalignment or underinflation. Impacts can damage the inner portion of the tire without being visible on the outside. If damage can be seen on the tires or wheels, or if you suspect that possible impact damage may have occurred, replace with spare at once and have your tire store or dealer inspect your tires immediately. Use of a damaged tire could result in tire destruction. When inspecting your tires, including the spare, check your air pressures. If your pressure check indicates that one of your tires has lost pressure of two pounds or more, look for signs of penetrations, valve leakage, or wheel damage that may account for the air loss.

All tires will wear out faster when subjected to high speeds as well as hard cornering, rapid starts, sudden stops, frequent driving on roads which are in poor condition, and off-road use. Roads with holes and rocks or other objects can damage tires and cause misalignment of your vehicle. When you drive on such roads, drive on them carefully and slowly, and before driving again at normal or highway speeds, examine your tires for any damage, such as cuts, bulges, penetrations, unusual wear patterns, etc.

(Continued on page 35)

* Provided by and published at the request of the tire manufacturers/warrantors.

TREAD WEAR INDICATORS (WEAR BARS): Tires contain Tread Wear Indicators (Wear Bars) in the grooves of the tire tread which **show up when only 2/32nds of an inch (1.6mm) of tread is remaining. At this stage, your tires must be replaced. Tires worn beyond this stage are dangerous.**

HAZARDS

Objects in the road that threaten a tire should be safely avoided. These objects are potholes, glass, metal, rocks, wood debris and the like. Unavoidable contact should prompt a thorough tire inspection.

You may not always recall hitting an object that can damage or injure your tires. If while driving your vehicle experiences any unusual vibrations, ride disturbance or noise and/or you suspect that possible damage to the tires or vehicle has occurred. **DO NOT JAM OR LOCK YOUR BRAKES!** Rather reduce your speed and drive with caution until you can safely pull off the road. Stop and inspect the tires. If the tire is underinflated or damaged, deflate, remove the tire and rim assembly and replace it with your spare. If you cannot detect a cause, have the vehicle towed to the nearest vehicle or tire dealer to have the vehicle inspected.

REPAIRING, MOUNTING AND DEMOUNTING OF TIRES

Do not attempt to repair, mount or demount a tire yourself. Tire changing can be dangerous and must be done by professionally trained persons using proper tools and procedures as specified by the Rubber Manufacturers Association (RMA). **Follow these mounting recommendations.** Your tires should be mounted on wheels of correct size and type and which are in good, clean condition. Bent, chipped or rusted wheels may cause tire damage. The inside of the tire must be free

from foreign materials. **Have your dealer check the wheels before mounting new tires.** Mismatched tires and rims can explode during mounting. Also, mismatched tires and rims can result in dangerous tire failure on the road. If a tire is mounted by error on the wrong-sized rim, do not remount it on the proper rim - scrap it. It may be damaged internally (which is not externally visible) by being dangerously stretched and could fail on the highway.

Old valves may leak. When new tubeless tires are mounted, have new valves of the correct type installed. Tubeless tires must be mounted only on wheels designed for tubeless tires, i.e., wheels which have safety humps or ledges.

Never perform a temporary repair, use an innertube or inject sealant as a permanent substitute for a proper repair. Only qualified persons should repair tires.

Be sure that all your valves have suitable valve caps. This will keep valve cores clean and clear and guard against leakage.

REPAIRS - WHENEVER POSSIBLE, SEE A TIRE DEALER AT ONCE. *Some tire manufacturers do not warrant any inspection or repair process. The repair is entirely the responsibility of the repairer.* Punctures in the tread of a passenger tire which do not exceed 1/4 of an inch (6mm) in diameter can usually be repaired by following the Rubber Manufacturer's Association (RMA) Passenger and Light Truck Repair procedures. *Contact the manufacturer of your tires for its position and assistance as to the acceptable location for a proper repair and the repair of speed rated tires.* **Do not use plug repairs. They may cause further damage to the tire. They are not always air tight and the plug may fail.** *Do not exceed posted speed limits on any repaired tire. Certain tire manufacturers speed ratings*

are voided if the tire is repaired.

Although a tire was properly repaired, internal structural damage resulting from the puncture may have occurred. Sometime later the damage may cause the tire to be removed from service.

If the tire has a puncture in the tread which exceeds 1/4 inch (6mm), the tire must be replaced. If any tire has sustained a puncture, have the tire inspected internally by a tire dealer for possible damage that may have occurred.

Improper mounting and inflation procedures can cause an explosion of the tire/rim assembly. Only specially trained persons should perform these tasks. Contact your tire store or dealer for assistance.

CAUTION - Never, under any circumstance, introduce a flammable substance into a tire.

WHEEL ALIGNMENT AND BALANCING

Wheel alignment and balancing are important for safety and maximum mileage from your tires. Check how your tires are wearing at least once a month. If your tires are wearing unevenly, such as the inside shoulder of the tire wearing faster than the rest of the tread, or if you detect excessive vibration, your vehicle may be out of alignment or balance. These conditions not only shorten the life of your tires, but adversely affect the handling characteristics of your vehicle which could be dangerous. If you detect irregular wear or vibration, have your alignment and balance checked immediately. Tires which have been run underinflated will show more wear on the shoulders than in the center of the tread.

* Provided by and published at the request of the tire manufacturers/warrantors.

HARD BRAKING

You must inspect your tires after any hard braking circumstances or after tires have slid on the pavement. This can cause a flat spot in a section of the tire tread.

TIRE SPINNING

Never spin your tires above a speedometer reading of 35 mph (55 km/h) if your vehicle becomes stuck. The centrifugal force generated by the free spinning tire/wheel assembly may cause a sudden tire explosion, resulting in vehicle damage and/or serious personal injury or death. Never allow anyone to stand near or behind a tire spinning at high speed while attempting to push a vehicle that is stuck. When in mud, sand, snow, ice or other slippery conditions, do not indulge in excessive wheel spin. In such conditions, with automatic transmission vehicles, by accelerating the engine excessively, it is possible to spin one of the drive tires beyond its speed capability. This is also true when balancing a drive tire/wheel assembly using the engine of the vehicle to spin the wheel.

TIRE TREAD

Tires must be replaced when the depth of the tread reaches 2/32 inch (1.6 mm). Tires are manufactured with tread wear indicators molded into the tire grooves which indicate tread wearout. As tires approximate 2/32 inch (1.6 mm) wearout, the tread gauge becomes thinner and more vulnerable to the effects of road hazards. Also, worn tires are more subject to hydroplaning, which can cause loss of control. Therefore, visual tire inspection becomes more crucial as the tires wear out.

WORN TIRES

Never drive on worn tires. Tires should be replaced by trained personnel when 2/32nds of an inch tread depth remains, as indicated by the tread wear indicators molded into the tread grooves. In most states, it is illegal to drive with less than 2/32nds of an inch of tread remaining.

TIRE MIXING

For best performance *select tires similar in size and load rating to the original equipment tires*. It is recommended that the same size and type of tire be used on all four wheel positions. In certain tires, casing ply material and ply construction may vary as indicated on the sidewall of the tire. When changing or replacing tires, it is preferred that all four tires are the same construction type (i.e., High Performance, All Season, Mud & Snow) and construction (Radial or Bias Ply). Before mixing tires of different types on a vehicle in any configuration, be sure to check the vehicle owner's manual for its recommendations.

Tires which meet the Rubber Manufacturer's Association (RMA) definition of mud and snow tires are marked M/S, M+S, M&S. On such tires, this designation is molded into the sidewall. Tires without this notation are not recommended for mud and/or snow driving.

If snow tires are needed, it is necessary to select tires equivalent in size and load rating to the original equipment tires. Always fit performance snow tires in sets of four (4) for optimum mud & snow traction and maintenance of vehicle handling characteristics. If you do not, it may adversely affect the safety and handling of your vehicle. It is also important to check the vehicle owner's manual before mixing or matching tires on 4-wheel drive vehicles as this may require special precautions.

Please refer to your Owner's Manual for more information on tire replacement precautions.

TIRE ROTATION

Tires on your Nissan vehicle should be rotated every 7,500 miles or as irregular wear develops. If irregular wear becomes apparent or if the wear rate on the tires is perceptibly uneven, the tires should be rotated in such a way to alleviate the problem. Check your vehicle for any mechanical problems and correct if necessary. Any rotation pattern or procedure may be followed including those indicated in the Owner's Manual. Some tires have arrows on the sidewall showing the direction in which the tire should turn. When rotating this type of tire, care must be taken to maintain the proper turning direction as indicated by the arrows. *Some vehicles have different tire sizes specified for front and rear axles. Tires on these vehicles should not be rotated side to side (unless they are directional)*. Where a temporary type spare tire is available, it should not be included in the tire rotation schedule. Such tires are intended for temporary use only. Whenever only two tires are replaced, the new tires should be put on the rear axle *of vehicles equipped with the same size tire on all four wheel positions*.

(Continued on page 37)

* Provided by and published at the request of the tire manufacturers/warrantors.

TRAILER TOWING

If you anticipate towing a trailer, you should see a tire dealer for advice concerning the correct size of tire and pressure. Tire size and pressure will depend on the type and size of the trailer and hitch utilized, but in no case must the maximum cold inflation pressure or the tire load rating be exceeded. Check the tire decal and your Owner's Manual for further recommendations on trailer towing.

TIRE ALTERATIONS

Do not perform any alterations on your tires. Alterations may prevent proper performance, leading to tire damage, which can result in an accident. Tires which become unserviceable due to alterations such as truing, whitewall inlays, addition of balancing or sealant liquids, may be excluded from warranty coverage. Consult your tire warranty.

HIGH PRESSURE TEMPORARY SPARE TIRES

- 1) The high-pressure spare tire in your Nissan vehicle is designed for temporary use only and must not be used continually as a regular tire. The standard tire should be repaired and/or replaced as soon as possible.
- 2) Avoid driving over obstacles that may damage the tire through impact or cutting, such as potholes, glass, metal, etc.

- 3) Speed must not exceed 50MPH (80km/h) for non-speed-rated temporary spare tires.
- 4) Temporary spare tires have a limited treadlife which can vary depending on road conditions and your driving habits. The spare tire should be returned to the trunk as soon as the standard tire can be repaired or replaced.
- 5) Because the high-pressure spare tire was specifically designed for your car, it should not be used on any other vehicle.
- 6) Do not use snow chains on your high-pressure spare. This could cause damage to your vehicle.
- 7) Check the tire's cold inflation pressure monthly and maintain at 60psi (4.2kg/cm²) even when not in use.
- 8) The high-pressure spare tire should not be used with any other rim nor should standard tires, wheel covers, or trim rings be used on the high-pressure spare tire rim which was originally installed.
- 9) When the tread wear indicator appears on the tire, replace it only with the same type spare tire.
- 10) Do not enter an automatic carwash with a temporary spare tire fitted.
- 11) Do not make a sharp turn or apply the brakes suddenly when driving on a high-pressure temporary spare.

Note: *When using any temporary type spare tire, be sure to follow the vehicle Owner's Manual instructions.*

TIRE STORAGE

All tires should be stored in a cool dry place indoors so that there is no danger of water collecting inside them.

When tires are stored they should be stored in a cool place away from sources of heat and ozone such as hot pipes and electric generators. Be sure that surfaces on which tires are stored are clean and free from grease, gasoline or other substances which could deteriorate the rubber. (Tires exposed to these materials during storage or driving could be subject to sudden failure.)

To Avoid Damage to your Tires and Possible Accident:

- Check tire pressure at least once a month when tires are cold and before long trips.
- Do not underinflate/overinflate.
- Do not overload.
- Drive at moderate speeds, observe legal limits.
- Avoid driving over potholes, obstacles, curbs or edges of pavement.
- Avoid excessive wheel spinning.
- If you see any damage to a tire, replace with spare and see the tire manufacturer's dealer or your Nissan dealership.

For further information, the *Consumer Tire Guide* on passenger tire care, safety and mileage performance is available in the United States by writing the Tire Industry Safety Council, Box 1801, Washington, D.C. 20013.

* Provided by and published at the request of the tire manufacturers/warrantors.

WHAT IS COVERED

Nissan* warrants to correct defects in materials or workmanship in all genuine Nissan replacement parts, Genuine NISMO S-tune parts, and Genuine Nissan accessories, distributed by Nissan North America in the United States, installed and used on Nissan or Infiniti (if an appropriate use and application of the part, accessory, or Genuine NISMO S-tune part) vehicles only, except as described under the caption below, "WHAT IS NOT COVERED."

This warranty covers any repairs needed to correct defects in materials or workmanship. Bedliners will be repaired to commercially acceptable standards subject to the conditions and limitations listed in "WHAT IS NOT COVERED."

*Nissan indicates Nissan North America, Inc., P.O. Box 685003, Franklin, TN 37068-5003 which distributes and provides consumer services for Nissan Vehicles in the United States.

HOW LONG IS THE WARRANTY

Except for replacement audio components, this warranty is for 12 months or 12,000 miles from the date of installation or purchase, whichever is earlier. However, the warranty on Genuine Nissan replacement parts, Genuine NISMO S-tune parts, and Genuine Nissan accessories installed in a Nissan or Infiniti vehicle while the vehicle is covered by a Nissan warranty, which would have covered the part had it been installed in the vehicle at manufacture, will not end before the end of that warranty.

REPLACEMENT AUDIO COMPONENTS

A replacement Radio, Tape Deck, Amplifier or Compact Disc Player/Auto Changer supplied by Nissan is covered for 12 months/unlimited mileage from the time of installation or the balance of the Basic Vehicle Warranty as it applies to audio components, whichever is greater.

WHAT IS NOT COVERED

This warranty does not cover:

1. Tires or batteries. These items are covered by separate warranties.
2. Nissan Motorsports and NISMO R-tune parts, including NISMO Legacy parts are sold "AS IS" without warranties, express or implied unless expressly prohibited from doing so by applicable law, in which case the warranty provided is the minimum required by law.
3. Normal maintenance service and parts replacement as outlined in the maintenance schedule of your OWNER'S MANUAL.
4. Damage or failures of parts resulting from:
 - Misuse (your OWNER'S MANUAL is your guide to proper use).
 - Accident, theft, fire, driving through water resulting in engine water ingestion.
 - Chemical fallout, tree sap, salt, sand, hail, flood or other environmental conditions.
 - Modification or improper repair of the part or of the vehicle in which the part is installed.
 - Use of parts not equivalent in quality or design to parts supplied by Nissan.
 - Lack of performance of required maintenance services as outlined in your OWNER'S MANUAL.
 - Use of improper or dirty fuel, fluids or lubricants.
 - Normal wear and tear, including dings, dents, chips or scratches.
5. SALVAGE TITLE. This warranty does not cover damage, failures or corrosion to any Nissan replacement part, Genuine NISMO S-Tune Part, or Genuine Nissan Accessory, installed in the vehicle, if the vehicle is issued a "salvage" or similar title. (This exclusion does not extend

to new Genuine Nissan replacement parts, NISMO S-tune parts or Genuine Nissan accessories, installed in a Nissan or Infiniti vehicle after the issuance of a "salvage" or similar title.)

WHAT YOU MUST DO

In order to obtain warranty service you must deliver the warranted part or accessory, or the vehicles, on which the part or accessory is installed, to an authorized Nissan or Infiniti dealer in the United States or Canada at your expense with proof of purchase (parts invoice or service repair order from an authorized Nissan or Infiniti dealer).

(Continued on page 39)

LIMITATION OF WARRANTIES AND OTHER WARRANTY TERMS AND STATE LAW RIGHTS

EXTRA EXPENSES - LIMITATIONS OF DAMAGES

This warranty does not cover incidental or consequential damages such as loss of the use of the vehicle, inconvenience or commercial loss.

ANY IMPLIED WARRANTY OF MERCHANTABILITY AND FITNESS FOR A PARTICULAR PURPOSE SHALL BE LIMITED TO THE DURATION OF THIS WRITTEN WARRANTY.

Some states do not allow the exclusion or limitation of incidental or consequential damages or limitations on how long an implied warranty lasts, so the above limitations or exclusions may not apply to you. This warranty gives you specific legal rights, and you may also have other rights, which vary from state to state.

Nissan does not authorize any person to create for it any other warranty, obligation or liability in connection with this vehicle.

The names and addresses of authorized Nissan and Infiniti dealers are listed in telephone directories.

You must also pay for labor charges to remove and replace the part or accessory if it was not originally installed on your vehicle by an authorized Nissan or Infiniti dealer.

WHAT NISSAN WILL DO

If the part or accessory to be repaired was originally installed by an authorized Nissan or Infiniti dealer, it will be removed and reinstalled after repair at no charge for parts and labor. If the part or accessory was not installed by an authorized Nissan or Infiniti dealer, the part or accessory will be repaired or exchanged only. Any needed parts replacement or exchange will be made using new or remanufactured parts at Nissan's option.

WHAT IS COVERED

Nissan² warrants to the first retail purchaser ("Original Repairing Vehicle Owner"), that Nissan will either repair or replace the Genuine Nissan Outer Sheet Metal Panels you install or have installed on your Nissan vehicle should the purchased panels develop inside out rust-through corrosion perforation. Replacement sheet metal panels must be installed on vehicles owned and operated in the United States and Canada. Nissan warrants to the Original Repairing Vehicle Owner that the replacement and refinishing of panels will be carried out at no cost to the Original Repairing Vehicle Owner subject to the exclusions listed.

WHAT IS NOT COVERED

This warranty becomes void when damage results from:

1. Accidents, collision, faulty installation, or any alteration to the panel, panels, or vehicle that could be reasonably expected to affect the performance of the covered panels.
2. Environmental pollution or conditions, including acid rain, hail, or lightning.
3. Vehicle neglect, abuse, or use of the vehicle for unintended purposes.
4. Stone chips, scratches, or other paint damage that lead to surface rust damage.
5. Cleaning and polishing agents, chemicals, and solvents, including improper undercoating or use of other rust prevention materials.

WHAT YOU MUST DO

The purchaser must present the Nissan Lifetime Replacement Panel Corrosion Warranty Form, original

receipts and/or repair orders, and personal identification to a Nissan dealership in order to invoke this warranty. The dealership will then authorize the replacement of the panels at a Nissan dealership's collision repair shop or an independent collision repair shop.

WHAT NISSAN WILL DO

Nissan will pay for the cost of the repair, including parts, labor, paint, and supplies necessary to repair or replace and refinish the panels purchased.

The repair may be completed at an authorized Nissan dealership's collision repair shop or an independent collision repair shop that will install Genuine Nissan replacement parts. Whether a Nissan dealership collision repair shop or independent collision repair shop completes the repair, only authorized Nissan dealership personnel or authorized Nissan personnel can approve a repair or replacement under this warranty.

LIMITATION OF WARRANTIES AND OTHER WARRANTY TERMS AND STATE LAW RIGHTS**EXTRA EXPENSES - LIMITATIONS OF DAMAGES**

This warranty does not cover incidental or consequential damages such as loss of the use of the vehicle, inconvenience or commercial loss.

ANY IMPLIED WARRANTY OF MERCHANTABILITY AND FITNESS FOR A PARTICULAR PURPOSE SHALL BE LIMITED TO THE DURATION OF THIS WRITTEN WARRANTY.

Some states do not allow the exclusion or limitation of incidental or consequential damages or limitations on how long an implied warranty lasts, so the above limitations or exclusions may not apply to you. This warranty gives you specific legal rights, and you may also have other rights which vary from state to state.

Nissan does not authorize any person to create for it any other warranty, obligation or liability in connection with this vehicle.

¹ The actual warranty is provided with the product purchased and should be read carefully.

² Nissan indicates Nissan North America, Inc., P.O. Box 685003, Franklin, TN 37068-5003, which distributes Nissan vehicles in the United States.

WHAT IS COVERED AND FOR HOW LONG

Nissan* warrants to correct defects in materials or workmanship, or for failure due to normal wear and tear, of all replacement **Genuine Nissan Original Equipment muffler assemblies, Genuine Nissan vehicle suspension system shock absorbers and strut assemblies** installed on Nissan vehicles only, except as described under the caption below, "WHAT IS NOT COVERED". **THE LIFETIME FEATURE OF THIS WARRANTY APPLIES ONLY IF** the parts are purchased and paid for by the owner of the vehicle on which they are installed, and only if they are installed by an authorized Nissan dealer, for as long as the original purchaser of the replacement **muffler assembly, shock absorber and/or strut assembly** owns the Nissan vehicle on which the parts are installed.

IMPORTANT: The lifetime feature of this warranty does not apply to parts (a) paid for in whole or in part by Nissan, to include warranty replacement, campaigns or goodwill adjustments, or (b) which are paid for under the terms of any service contract. Such parts are instead warranted against defects in material or workmanship only (but not failure due to normal wear and tear) for 12 months or 12,000 miles from the date of installation or purchase, whichever is earlier. In no case shall the warranty from defects in material or workmanship end prior to the end of the applicable Nissan New Vehicle Limited Warranty on the Nissan vehicle on which the parts are installed, had the part(s) been installed in the vehicle at manufacture.

*Nissan indicates Nissan North America, Inc., P.O. Box 685003, Franklin, TN 37068-5003 which provides consumer service for Nissan vehicles in the United States.

LIMITATION OF WARRANTIES AND OTHER WARRANTY TERMS AND STATE LAW RIGHTS**Extra Expenses - Limitations of Damages**

This warranty does not cover incidental or consequential damages such as loss of the use of a vehicle, substitute transportation, inconvenience or commercial loss.

ANY IMPLIED WARRANTY OF MERCHANTABILITY AND FITNESS FOR A PARTICULAR PURPOSE SHALL BE LIMITED TO THE DURATION OF THIS WRITTEN WARRANTY.

Some states do not allow the exclusion or limitation of incidental or consequential damages or limitations on how long an implied warranty lasts, so the above limitations may not apply to you. This warranty gives you specific legal rights, and you may also have other rights which vary from state to state.

Nissan does not authorize any person to create for it any other warranty, obligation or liability in connection with the part(s) subject to this express limited warranty.

WHAT IS NOT COVERED

This warranty does not cover:

1. Genuine Nissan Key Value® Muffler Assemblies.
2. Shock absorbers and strut assemblies installed before July 1, 1999. Muffler assemblies installed before October 1, 1999.
3. Motorsports Parts and Genuine NISMO R-Tune parts are sold "AS IS" without warranties, express or implied unless expressly prohibited from doing so by applicable law, in which case the warranty is the minimum provided by law.

4. Damage or failure(s) of parts resulting from:
 - Misuse (your OWNER'S MANUAL is your guide to proper use.)
 - Accident, theft, fire, driving through water.
 - Salt, sand, flood or other environmental conditions.
 - Modification or improper repair of the part or of the vehicle in which the part is installed.
 - Use of parts not equivalent in quality or design to parts supplied by Nissan.
5. Salvage Title. This warranty does not apply and is rendered VOID if the vehicle is issued a "salvage," "flood," or similar title under any state's law after the part(s) is purchased unless state law expressly states otherwise. (This exclusion does not extend to new Genuine Nissan Original Equipment muffler assemblies, Genuine Nissan shock absorbers or strut assemblies purchased and installed in the vehicle after the issuance of a "salvage," "flood," or similar title.)

(Continued on page 42)

WHAT YOU MUST DO

In order to obtain lifetime limited warranty service, bring your vehicle, proof-of-purchase (service repair order from an authorized Nissan dealer in the United States) and personal identification (driver's license, etc.) to any authorized Nissan dealer in the United States. The names and addresses of authorized Nissan dealers are listed in telephone directories.

WHAT NISSAN WILL DO

If the lifetime feature of this warranty applies to a Genuine Nissan Original Equipment **muffler assembly, shock absorber** or **strut assembly** it will be removed and reinstalled after repair at an authorized Nissan dealer at no charge for parts or labor.

Otherwise a warranted Genuine Nissan Original Equipment **muffler assembly, shock absorber** or **strut assembly** will be exchanged only unless you can provide proof that it was originally installed by a Nissan dealer, in which case it will be removed and reinstalled after repair at no charge to you for parts or labor during the term of the warranty. Any needed parts replacement or exchange will be made using new or remanufactured parts at Nissan's option.

WHAT IS COVERED?

Nissan * Warrants your Genuine Nissan Replacement Battery as described below except as stated under "What is not covered?"

This warranty covers defects in materials and workmanship.

HOW LONG IS THE WARRANTY AND WHAT WILL NISSAN DO

Nissan will replace your battery without charge if it becomes unserviceable within the first 24 months of service.

If the battery becomes unserviceable after 24 months of use, Nissan will provide a replacement battery at a reduced price, charging only for the portion of the life of the battery actually used. This is called a "pro-rata adjustment". Nissan will pay for all labor charges in replacing the battery if it was originally installed by an authorized Nissan dealer.

This warranty and the "pro-rata adjustment" end 84 months after the date of the battery's purchase or installation, whichever is earlier.

WHAT IS NOT COVERED?

This warranty does not cover:

1. Damage or failure resulting from:
 - Accident, theft, fire or freezing.
 - Misuse of the battery or vehicle in which it is installed, including the use in applications for which the battery was not designed. Proper use is described in the vehicles Owner's Manual.
 - Improper installation or battery charging.
 - Vehicle electrical malfunctions not covered by our New Vehicle Limited Warranty.

- Modification or improper repair of the vehicle or a part of the vehicle.
 - Use of parts not equivalent in quality or design to parts supplied by Nissan.
 - Environmental conditions, including, but not limited to flood, and salt spray or salt water.
2. Normal maintenance service and recharging of discharged batteries.
 3. Batteries in service more than 84 months.
 4. Salvage Title. This warranty does not cover damage, failure, or corrosion to any Genuine Nissan battery installed in the vehicle, if the vehicle is issued a "salvage" or similar title under any state's law, and this warranty is rendered void for any battery installed in a vehicle prior to the vehicle being issued a "salvage" or similar title unless state law expressly states otherwise. (This exclusion does not extend to a new Genuine Nissan battery installed in the vehicle after the issuance of a "salvage" or similar title).

WHAT YOU MUST DO

In order to obtain warranty service, you must deliver the warranted battery or the vehicle in which the battery is installed to an authorized Nissan dealer in the U.S. or Canada at your expense, with proof of purchase (parts invoice or service repair order from an authorized Infiniti dealer). The names and addresses of authorized Nissan dealers are listed in telephone directories or www.NissanUSA.com

If the "pro-rata adjustment" applies, you must pay for the portion of the 84 month warrantable life that you actually used. The amount you pay is computed in two steps. First, the customer pay percentage is determined from the chart shown below based upon the months of actual battery service.

| Months In Service | Customer Pay Percentage |
|-------------------|-------------------------|
| 0-24 | 0% |
| 25-32 | 25% |
| 33-50 | 50% |
| 51-84 | 75% |

Second, the current suggested retail price of the new battery is multiplied by the customer pay percentage. For example, should the battery fail after 40 months of service you would pay 50% of the suggested retail price of the new battery.

You must also pay for the labor charge to remove and replace the battery if it was not originally installed in your vehicle by an authorized Nissan Dealer.

LIMITATION OF WARRANTIES AND OTHER WARRANTY TERMS AND STATE LAW RIGHTS
EXTRA EXPENSES-LIMITATIONS OF DAMAGES

This warranty does not cover incidental or consequential damages such as, but not limited to, loss of wages or loss of use of the vehicle, inconvenience, or commercial loss.

ANY IMPLIED WARRANTY OF MERCHANTABILITY AND FITNESS FOR A PARTICULAR PURPOSE IS LIMITED TO THE DURATION OF THE LIMITED WARRANTY.

Some states do not allow the exclusion or limitation of incidental or consequential damages or limitations, so the above limitations or exclusions may not apply to you. This warranty gives you specific legal rights, and you may also have other rights, which vary from state to state.

Nissan does not authorize any person to create for it any other warranty, obligation or liability in connection with this vehicle.

* NISSAN indicates Nissan North America, Inc. PO Box 685003, Franklin, TN 37068-5003, which distributes Nissan vehicles and provides related consumer services in the United States of America

Nissan North America, Inc. and your Nissan dealer realize that there are numerous sources for parts and accessories in today's automotive parts aftermarket. However, Genuine Nissan parts and accessories are designed and manufactured to meet the same factory fit, performance and quality specifications of your Nissan vehicle.

The Parts Department of your Nissan dealership maintains a complete inventory of high quality Genuine Nissan new and remanufactured replacement parts - parts that are backed by one of the most comprehensive parts warranties available in the automotive industry today.

To ensure that your warranty, maintenance and repair parts requirements are satisfied as quickly as possible, Nissan and the Nissan dealer organization maintain a combined inventory consisting of several hundred million dollars worth of readily available parts and popular accessories. In the event a critical part is required that is not stocked by your local dealership, Nissan's ordering system includes a computerized means of ensuring the quickest possible shipment to Nissan dealers by the use of expeditious handling and premium transportation - all of which is supported by one of the most extensive and efficient parts distribution systems in the United States.

Two Nissan North America, Inc. Regional Parts Distribution Centers stock approximately 32,000 different parts and each of five additional Area Parts Distribution

Centers service over 61,000 part numbers. Nissan's Master Parts Distribution Center in Compton, California maintains an inventory of 150,000 low volume part numbers and services all Nissan dealers nationally. All Nissan parts distribution facilities are linked via a sophisticated computer search and order system to ensure coordinated parts ordering, inventory and distribution of available parts.

The Nissan name represents quality and a commitment to your satisfaction as a valued customer. So when you select parts or accessories for your Nissan vehicle, see your Nissan dealer. Only Nissan builds Nissan replacement parts and accessories to exact factory specifications.

RECOMMENDATION FOR MAINTENANCE SERVICE AND REPLACEMENT PARTS FOR YOUR VEHICLE'S EMISSION SYSTEM

To assure best results and to maintain the original quality built into the emission control systems, it is recommended that genuine Nissan parts be used when servicing or repairing the systems. THE WARRANTY OBLIGATIONS ARE NOT DEPENDENT UPON THE USE OF ANY PARTICULAR BRAND OF REPLACEMENT PARTS AND THE OWNER MAY ELECT TO USE NON-GENUINE NISSAN PARTS FOR REPLACEMENT PURPOSES.

The use of replacement parts which are not equivalent to genuine Nissan parts may reduce the effectiveness of the emission control system.

Therefore, if it becomes necessary to use other than genuine Nissan parts, the owner should assure himself that such parts are warranted by their manufacturer to be equivalent in quality to genuine Nissan parts.

MAINTENANCE, REPLACEMENT OR REPAIR OF THE EMISSION CONTROL DEVICES AND SYSTEMS MAY BE PERFORMED BY ANY AUTOMOTIVE REPAIR ESTABLISHMENT OR INDIVIDUAL USING ANY REPLACEMENT PART.

HOWEVER, UNLESS OTHERWISE AUTHORIZED BY LAW, WARRANTY SERVICE MUST BE PERFORMED BY AN AUTHORIZED NISSAN DEALER.

The emission standards may be satisfied by having the vehicle inspected periodically and by following the requirements outlined in your OWNER'S MANUAL and your NISSAN SERVICE MAINTENANCE GUIDE.

In order to help protect your vehicle against corrosion, it is important that you care for your vehicle regularly, following these suggestions:

- Wash your vehicle regularly using cold clean water and a mild vehicle wash soap.
- If insects, tar or other similar deposits have accumulated on your vehicle, wash it as soon as possible.
- If you drive on salted or dust controlled roads, or if you drive near the ocean, hose off the under carriage at least once a month.
- It is important that the drain holes in the lower edges of the doors and rocker panels be kept clear.
- If you detect any stone chips or scratches in the paint, touch them up immediately.
- If you do much driving on gravel roads, consider installing mud or stone shields behind each wheel.
- If your Nissan is damaged due to an accident or similar cause which destroys the paint and protective coating, have your vehicle repaired as soon as possible. The cost of such repairs is considered the responsibility of the owner.
- This corrosion warranty does not cover non-genuine sheet metal parts or damage caused by the installation of such non-genuine sheet metal parts.

SEE YOUR OWNER'S MANUAL FOR FURTHER DETAILS.



Security+Plus[®]

VEHICLE PROTECTION PLAN

LONG TERM MECHANICAL PROTECTION FOR YOUR NISSAN...

For extra peace of mind you can add Nissan's own Security+Plus[®] Vehicle Protection Plan which provides you with long term mechanical protection. Backed by Nissan, and designed exclusively for Nissan owners, Security+Plus[®] is available from your Nissan dealer in a variety of comprehensive coverages.

Just a few of its major features:

1. **With Security+Plus[®], you can choose from a full spectrum of term options to fit your ownership (time) and driving (mileage) needs.**
2. **Repairs can be performed at participating Nissan dealerships throughout the U.S., excluding U.S. Territories. Repairs at these dealerships are performed by factory trained technicians using Genuine Nissan parts, to keep your vehicle in top running condition.**
3. **All new Security+Plus[®] Service Agreements are transferable to subsequent owners, thus ensuring flexibility of your investment and enhancing the resale value of your Nissan.**

YOU SIMPLY CAN'T GET BETTER LONG-TERM PROTECTION FOR YOUR MONEY THAN WITH NISSAN'S SECURITY+PLUS[®]!

For details, please contact your authorized Nissan Dealer or complete the attached business reply card (no postage necessary) and mail it to:

**Nissan Security+Plus[®] Headquarters
P.O. Box 685004
Franklin, TN 37068-5004**

We'll send you a complete information packet by return mail. Do it today! The quicker you act, the sooner you can have the full protection of a Nissan Security+Plus[®] Service Agreement.

NOTE: Security+Plus[®] Service Agreements for previously owned Nissan vehicles can only be purchased from your authorized Nissan dealership at the time of vehicle sale.

MEMO

MEMO

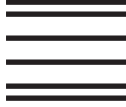

NO POSTAGE
NECESSARY
MAILED
IN THE
UNITED STATES

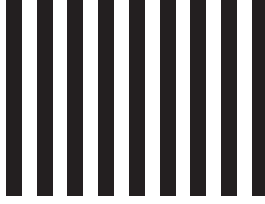

BUSINESS REPLY MAIL

FIRST CLASS MAIL PERMIT NO. 97 FRANKLIN, TN

POSTAGE WILL BE PAID BY ADDRESSEE

NISSAN SECURITY + PLUS® HEADQUARTERS

PO BOX 685004

FRANKLIN, TN 37068-5004

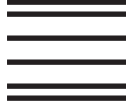
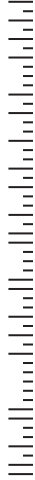

NO POSTAGE
NECESSARY
MAILED
IN THE
UNITED STATES

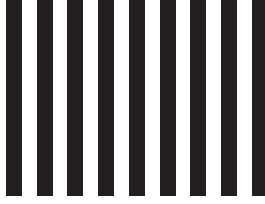

BUSINESS REPLY MAIL

FIRST CLASS MAIL PERMIT NO. 97 FRANKLIN, TN

POSTAGE WILL BE PAID BY ADDRESSEE

NISSAN NORTH AMERICA, INC.

PO BOX 685003

FRANKLIN, TN 37068-5003

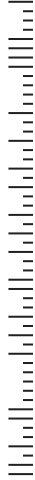

NISSAN

PE11-020

NISSAN

8/31/2011

ATTACHMENT A

Question 6 documents_2008

Warranty Information



2008 WARRANTY INFORMATION BOOKLET

NOTICE:

The coverage period of the New Vehicle Limited Warranty applicable to your Nissan vehicle equipped with Continuously Variable Transmission is extended to 10 years/120,000 miles, whichever comes first, for transmission repairs, replacement and related towing only. The warranty, including all terms, limitations and conditions, otherwise remains unchanged.

| | | | |
|-----------|--|-----------|--|
| 1 | SUMMARY OF WARRANTY COVERAGE AT A GLANCE | 14 | SEAT BELT LIMITED WARRANTY |
| 2 | NISSAN'S CUSTOMER CARE PROGRAM | 15 | BFGOODRICH TIRE LIMITED WARRANTY |
| 3 | NISSAN'S COMMITMENT TO CUSTOMER SATISFACTION | 17 | BRIDGESTONE / FIRESTONE TIRE LIMITED WARRANTY |
| 4 | 2008 NEW VEHICLE LIMITED WARRANTY | 19 | DUNLOP PASSENGER TIRE LIMITED WARRANTY |
| 7 | FEDERAL VEHICLE EMISSION CONTROL LIMITED WARRANTIES | 23 | GENERAL TIRE LIMITED WARRANTY |
| 10 | CALIFORNIA VEHICLE EMISSION CONTROL WARRANTIES | 26 | GOODYEAR TIRE LIMITED WARRANTY |

TABLE OF CONTENTS

| | | | |
|----|---|----|---|
| 28 | MICHELIN TIRE LIMITED WARRANTY | 41 | GENUINE NISSAN ORIGINAL EQUIPMENT MUFFLER, GENUINE NISSAN SHOCK ABSORBER AND STRUT LIFETIME LIMITED WARRANTY |
| 30 | TOYO TIRE LIMITED WARRANTY | | |
| 32 | ORIGINAL EQUIPMENT TIRE LIMITED WARRANTIES | 43 | REPLACEMENT BATTERY LIMITED WARRANTY |
| 33 | IMPORTANT TIRE SAFETY INFORMATION | 44 | GENUINE NISSAN PARTS AND ACCESSORIES |
| 38 | LIMITED WARRANTY ON GENUINE NISSAN REPLACEMENT PARTS, GENUINE NISMO S-TUNE PARTS, AND GENUINE NISSAN ACCESSORIES | 45 | CORROSION PROTECTION GUIDELINES |
| 40 | SUMMARY OF NISSAN LIFETIME REPLACEMENT PANEL CORROSION WARRANTY | 46 | NISSAN'S SECURITY+PLUS® VEHICLE PROTECTION PLAN |

Summary of Warranty Coverage*

| | 0 miles | 90,000 miles |
|---|--------------------------------------|--------------|
| Basic Coverage | 36 months / 36,000 miles | |
| Corrosion Coverage (Perforation) | 60 months / UNLIMITED MILEAGE | |
| Powertrain Coverage | 60 months / 60,000 miles | |
| Federal Emission Performance | 24 months / 24,000 miles | |
| Federal Emission Defect | 36 months / 36,000 miles | |
| Federal Emission Long Term Defect | 96 months / 80,000 miles | |
| California Emission Performance | 36 months / 50,000 miles** | |
| California Emission Defect | 36 months / 50,000 miles** | |
| California Emission Long Term Defect | 84 months / 70,000 miles** | |
| Seat Belt | 120 months/unlimited mileage | |

* See the express terms of the appropriate warranty printed in this booklet, which terms control if there is a conflict with this chart.

California Emission Altima with 2.5 engine **ONLY: Warranty coverage is 15 years/150,000 miles, whichever occurs first.

NISSAN CARES...

Both Nissan and your Nissan dealer are dedicated to serving all your automotive needs. Your complete satisfaction with your vehicle and your Nissan dealer are our primary concerns. Your Nissan dealer is always available to assist you with all your automobile service requirements.

If, however, a situation arises that you believe has not been addressed to your satisfaction, we ask that you take the following steps:

STEP 1:

Discuss the situation with the dealership's manager. If a problem still exists, contact the dealership's Consumer Affairs Manager or owner. They are best equipped to resolve the matter for you.

STEP 2:

If the concern has still not been addressed to your satisfaction, please contact our (Nissan's) Consumer Affairs Department using our toll free number:



1-800-NISSAN-1
(1-800-647-7261)

The Consumer Affairs Department will ask for the following information:

- Your name, address, and telephone number
- Vehicle identification number (on dashboard)
- Date of purchase
- Current odometer reading
- Your Nissan dealer's name
- Details of the concern

Or you can write to Nissan with the above information at:

Nissan North America, Inc.
Consumer Affairs Department
P.O. Box 685003
Franklin, TN 37068-5003

STEP 3:

In the event that you believe Nissan has been unable to satisfactorily address the issue with your vehicle, a special automotive complaint resolution program called BBB AUTO LINE is available to you. The BBB AUTO LINE program is independently operated by the Council of Better Business Bureaus, Inc. (BBB).

For information about the BBB AUTO LINE in your area, please call us (Nissan) at the same toll free number (1-800-NISSAN-1). We will be happy to provide you with information about BBB AUTO LINE. Or, you may contact the BBB directly at:

BBB Auto Line
Council of Better Business Bureaus, Inc.
4200 Wilson Blvd.
Arlington, VA 22203
1 (800) 955-5100

If you call the BBB, its staff will take down details of your complaint by telephone. They will ask for the same information as described in Step 2.

The BBB AUTO LINE program consists of two parts, **mediation** and **arbitration**. The BBB will attempt to assist you to resolve the problem during mediation. If a satisfactory resolution has not been achieved during mediation, you will have the opportunity to personally present your case before an impartial arbitrator or three-person panel. The arbitrator(s) will make a decision after the arbitration hearing.

The BBB will, in most cases, send you a final decision within forty (40) days (plus 7 if you have not contacted the proper person from the dealership or Nissan) unless you delay the process. If you accept the decision, it will be legally binding on you and Nissan. If you do not accept the decision, it will not be legally binding on you or Nissan. (However in some states, if the decision is not accepted, it may be introduced either by you or by Nissan, as evidence in any potentially related court action.)

BBB AUTO LINE is an informal dispute settlement mechanism operated to comply with applicable Federal law and regulations. In states where BBB AUTO LINE is available, you are required to use BBB AUTO LINE before exercising rights or seeking remedies under Title I of the Federal Magnuson-Moss Warranty Act, 15 U.S.C. §2301, et. seq. If you choose to seek remedies other than those created by Title I of the Magnuson-Moss Warranty Act, (for example, under state law), that Federal Act does not require you to first use BBB AUTO LINE. The program is still available to you, however, and may be of considerable assistance. Some states specify that informal dispute settlement mechanisms such as BBB AUTO LINE must be used before you may use state-operated complaint resolution processes, before you may file a lawsuit under state law, and/or before you may have certain other rights or remedies available under state law. In accordance with those states' laws, Nissan requires the prior use of BBB AUTO LINE in good faith before you resort to such other processes, file a lawsuit, or seek other remedies provided by state law. Please see the "2008 Nissan Warranty Information Booklet & 2008 Nissan Owner's Manual" for additional information.

BBB AUTO LINE may not be available in all states. We, Nissan, would be pleased to provide you with information about the availability of BBB AUTO LINE in your state, or call the BBB AUTO LINE number listed above.

For additional information on the Auto Line program, please refer to the information on your state in the Supplement to Nissan Warranty Information Booklet.

ASSISTANCE OUTSIDE OF WARRANTY

In our continuing effort to convey our commitment to service and customer satisfaction, Nissan may occasionally offer to pay or reimburse for part or all of the cost of making certain, specific repairs beyond or outside of the terms of the warranty for some specific vehicle models. (Some states refer to such programs as "adjustment programs"). In such circumstances Nissan mails notices to all known registered owners of affected vehicles. You may additionally inquire of your authorized Nissan Dealer or of Nissan directly at the number listed below of the applicability of such programs to your vehicle.

Nissan may occasionally offer special assistance that may pay for part or all of vehicle repairs beyond the expiration of the limited warranty period on a case by case basis. Should you experience unusual difficulties with your vehicle please discuss the situation with your dealer. If your dealer is unable to assist you, you may call the Nissan Consumer Affairs Department at 1-800-NISSAN-1 to discuss your concern. You will need to provide the Model, Model Year, VIN (Vehicle Identification Number), mileage, maintenance history, a detailed explanation of the concern, and why you believe that Nissan should be responsible for the repair. Your request will be individually investigated and you will be informed of Nissan's decision.



1-800-NISSAN-1
(1-800-647-7261)

Please also review the "Supplement to the 2008 Nissan Warranty Information Booklet & 2008 Nissan Owner's Manual" for important information concerning consumer rights in your state.

WHO IS THE WARRANTOR

Nissan¹ warrants all parts of your 2008 Nissan vehicle supplied by Nissan, except for those listed elsewhere under the caption "WHAT IS NOT COVERED."

APPLICABILITY

- This warranty is provided to the original and subsequent owner(s) of a Nissan vehicle originally distributed by Nissan which is originally sold by a Nissan authorized Nissan dealership in the United States, and which is registered in the U.S. and normally operated in the United States (including Alaska and Hawaii), the United States territories (specifically Guam, Saipan, American Samoa, Puerto Rico and the U.S. Virgin Islands), and Canada.
- This warranty is generally transferable from the original 'owner other than a Nissan dealer' (OWNER) to subsequent owners of the vehicle at any time ownership of the vehicle is transferred, without any action on your part; except that this warranty is not transferable but is instead void if during the first six months after delivery to the original OWNER: (1) ownership of the vehicle is transferred from the original OWNER, and (2) the vehicle is registered outside of the United States.
- Your Nissan vehicle is manufactured to meet U.S. regulations and environmental requirements. With the exception of privately owned vehicles belonging to members of the U.S. military or employees and officers of the United States Government stationed abroad, this warranty does not apply if an otherwise covered vehicle is operated in, or relocated to, a country other than those listed above under this caption, except that it continues to apply if the vehicle is operated in full compliance with its proper use as described in the applicable OWNER'S MANUAL² while touring outside of the United States, the U.S. territories or Canada for a period not exceeding sixty (60) consecutive days or sixty (60) days in any one 12 month period. Subject to the transferability restriction described above, this

warranty applies to a relocated vehicle which is returned to, and is registered and normally operated in the United States, the U.S. territories or Canada, except for conditions due to the vehicle's foreign operation, e.g., use of inappropriate fuels or other fluids.

LIMITATION OF WARRANTIES AND OTHER WARRANTY TERMS AND STATE LAW RIGHTS**EXTRA EXPENSES - LIMITATIONS OF DAMAGES**

This warranty does not cover incidental or consequential damages such as loss of the use of the vehicle, inconvenience or commercial loss.

ANY IMPLIED WARRANTY OF MERCHANTABILITY AND FITNESS FOR A PARTICULAR PURPOSE SHALL BE LIMITED TO THE DURATION OF THIS WRITTEN WARRANTY.

Some states do not allow the exclusion or limitation of incidental or consequential damages or limitations on how long an implied warranty lasts, so the above limitations or exclusions may not apply to you. This warranty gives you specific legal rights, and you may also have other rights which vary from state to state.

Nissan does not authorize any person to create for it any other warranty, obligation or liability in connection with this vehicle.

Nissan makes available to you, and you are specifically required by Federal Law to use BBB AUTO LINE ((800) 955-5100) before exercising rights or seeking remedies under the Federal Magnuson-Moss Warranty Act, 15 U.S.C. §2301, et. seq. You are not required to first use BBB AUTO LINE if you seek remedies not created by Title I of that Federal law, but are required to first use BBB AUTO LINE if you seek remedies created by state law, including your state's lemon law, if applicable state law provides for using a 703 compliant or similar process before filing suit. Please refer to pp. 2-3 of this booklet and the "Supplement to 2008 Nissan Warranty Information Booklet & 2008 Nissan Owner's Manual" for additional information.

THE WARRANTY BEGINS

The warranty period begins on the date the vehicle is delivered to the first retail buyer or put into use, whichever is earlier.

FOR HOW LONG AND WHAT IS COVERED**■ BASIC COVERAGE**

- The basic coverage period is 36 months or 36,000 miles, whichever comes first.
- This warranty covers any repairs needed to correct defects in materials or workmanship of all parts and components of each new Nissan vehicle supplied by Nissan except for the exclusions or items listed under the caption "WHAT IS NOT COVERED" or, if the part is covered by one of the separate coverages described in the following sections of this warranty, that specific coverage applies instead of the basic coverage.
- Bedliners will be repaired to commercially acceptable standards subject to the conditions and limitations listed in "WHAT IS NOT COVERED."

■ POWERTRAIN COVERAGE

- The Powertrain coverage period is 60 months or 60,000 miles, whichever comes first.
- This warranty covers any repairs needed to correct defects in materials or workmanship.
- Powertrain coverage applies to components listed below, supplied by Nissan except for those items listed under the caption "WHAT IS NOT COVERED".

ENGINE

Cylinder heads and block and all internal parts, rocker covers and oil pan, valve train and front cover, timing chain and tensioner, oil pump, water pump and fuel pump, fuel injectors, intake and exhaust manifolds and supercharger, flywheel, seals, and gaskets.

TRANSMISSION AND TRANSAXLE

Case and all internal parts, torque converter and converter housing, automatic transmission control module, transfer

¹ Nissan indicates Nissan North America, Inc., P.O. Box 685003, Franklin, TN 37068-5003 which distributes Nissan vehicles in the United States.

² See the Owner's Manual for information relevant to proper operation of the vehicle, including the recommended fuels and fluids.

case and all internal parts, seals and gaskets, clutch cover and housing, and electronic transmission controls.

DRIVETRAIN

Drive shafts, final drive housing and all internal parts, propeller shafts, universal joints, bearings, seals and gaskets.

RESTRAINT SYSTEM

Air bags and related electronic control systems.

■ **CORROSION COVERAGE (PERFORATION FROM CORROSION)**

Any body sheet metal panel supplied by Nissan found to have developed perforation (rust-through) due to corrosion in normal use is covered for 60 months, regardless of mileage, except for those items listed under "WHAT IS NOT COVERED". No additional rust proofing applications are required. Perforation is a condition in which any body sheet metal panel has corroded from one surface through to another.

■ **ORIGINAL EQUIPMENT BATTERY COVERAGE (For replacement battery coverage, see page 43)**

The coverage period is 36 months or 36,000 miles, whichever comes first. A defective original equipment battery which is unserviceable within the first 12 months and 36,000 miles will be replaced free of charge. After 12 months but within 24 months and 36,000 miles, you will pay 50% of the replacement battery's suggested retail price plus any applicable taxes. After 24 months but within 36 months and 36,000 miles, you will pay 75% of the replacement battery's suggested retail price plus any applicable taxes. Nissan will pay the rest, including all labor to remove and replace the defective battery.

■ **TOWING COVERAGE**

If your vehicle is inoperative due to the failure of a warranted part, towing service to the nearest authorized Nissan dealer is covered for 36 months or 36,000 miles, whichever comes first.

■ **ADJUSTMENT COVERAGE**

Service adjustments not usually associated with the replacement of parts, such as wheel alignment, are covered only during the first 12 months or 12,000 miles, whichever comes first.

■ **REFRIGERANT RECHARGE ONLY COVERAGE**

Refrigerant recharge not associated with the repair or replacement of a warranted part is covered only during the first 12 months, regardless of the mileage.

NO CHARGE

Warranty repairs will be made at no charge for parts and/or labor (except for batteries and tires, in which case you may pay certain charges as noted above or as described in the applicable tire warranty found later in this booklet). **Any needed parts replacement will be made using genuine Nissan or Nissan approved new or remanufactured parts.**

OBTAINING WARRANTY SERVICE

- You must take the vehicle to an authorized Nissan dealer in the United States or Canada during regular business hours at your expense in order to obtain warranty service. The names and addresses of authorized Nissan dealers are listed in telephone directories.
- If you require warranty service outside of the United States (see terms under caption "APPLICABILITY"), contact an authorized Nissan dealer in that country. Note that complaints related to failure to comply with proper use of the vehicle as described in the applicable OWNER'S MANUAL (including the lack of availability or use of proper

fuel and fluids), or the vehicle's lack of compliance with local regulations or environmental requirements of any country (other than the U.S., the listed U.S. territories or Canada) are not covered by this warranty.

MAINTENANCE AND RECORDS

As a condition of this warranty, you are responsible for properly using, maintaining and caring for your vehicle as outlined in your OWNER'S MANUAL and your NISSAN SERVICE & MAINTENANCE GUIDE, and maintaining copies of all maintenance records & receipts for review by Nissan. Failure to do so is likely to result in the denial of warranty coverage.

Evidence of the performance of the required maintenance should be kept and presented as proof of such maintenance in connection with related warranty repairs. To assist you in maintaining appropriate records, the maintenance log located in your NISSAN SERVICE & MAINTENANCE GUIDE can be used along with supporting repair invoices, receipts and other such records.

(Continued on page 6)

**(See following page for
"WHAT IS NOT COVERED.")**

WHAT IS NOT COVERED **DAMAGE, FAILURES OR CORROSION DUE TO** **ACCIDENTS, MISUSE OR ALTERATIONS**

This warranty does not cover damage, failures or corrosion resulting from:

- Accident, theft, fire, driving through water (including engine water ingestion) or misuse, which includes racing of any sort whatsoever (Proper use is outlined in your OWNER'S MANUAL).
- Alteration, tampering or improper repair.
- Installation of non-Nissan approved accessories or components.
- Improper installation of any Nissan approved or aftermarket accessory or component.
- Glass breakage, unless resulting from defects in material or workmanship.
- Normal wear and tear, including dings, dents, chips or scratches.

ALTERED OR UNCERTAIN ODOMETER MILEAGE

This warranty does not cover repair of any vehicle or any part of a vehicle of which the odometer mileage has been altered, or the odometer repaired or replaced and the actual vehicle mileage cannot be correctly and readily determined.

SALVAGE TITLE

This limited warranty does not apply to any vehicle, and is rendered void if the vehicle is (or ever has been) issued a "salvage" or similar title under any state's law; or has ever been determined to be a "total loss" or equivalent by any insurance company, such as by payment of a cash payment of claim in lieu of repairs because of a determination that the cost of repairs exceeded the actual cash value of the vehicle.

DAMAGE, FAILURES OR CORROSION FROM **ENVIRONMENTAL CONDITIONS**

This warranty does not cover damage, failures or corrosion resulting from:

- Stone chipping, chemical fallout (acid rain), tree sap, salt, hail, wind-storm, lightning, flood or other environmental conditions.

- The items listed below are not covered under corrosion coverage (perforation from corrosion).
 - Exhaust system components.
 - Corrosion of outer trim parts, such as moldings. However, corrosion of outer trim parts is warranted for 12 months or 12,500 miles, whichever comes first.
 - Corrosion other than perforation, such as cosmetic or surface corrosion due to defects in materials or workmanship. This is covered under the Basic Coverage of the New Vehicle Limited Warranty.
 - Special bodies or equipment not manufactured or supplied by Nissan.

DAMAGE, FAILURES OR CORROSION DUE TO LACK **OF OR IMPROPER MAINTENANCE**

This warranty does not cover damage, failures or corrosion resulting from:

- Lack of performance of proper maintenance services as outlined in your NISSAN SERVICE & MAINTENANCE GUIDE.
- Use of improper or dirty fuel, fluids or lubricants.
- Use of parts not equivalent in quality or design to parts supplied by Nissan.

MAINTENANCE SERVICE EXPENSE

This warranty does not cover normal maintenance services as specified in your NISSAN SERVICE & MAINTENANCE GUIDE such as engine tune-up; cleaning and polishing; wheel alignment; headlight aiming; replacement of filters, replacement of windshield wiper inserts, replacement of key fob batteries, lubricants, coolant; worn brake shoes, pads, drums and rotors and worn clutch discs.

SEAT BELTS, TIRES, DROP-IN BEDLINERS AND **EMISSION CONTROL SYSTEM**

Seat belts, tires, drop-in bedliners and the emission control system are not covered by this warranty, but are covered by separate warranties.

NISSAN SPRAY-IN BEDLINERS

Nissan Spray-in Bedliners will be repaired to commercially acceptable standards which may include minor appearance differences from the original bedliner.

(See following pages for separate warranties which may apply to your Nissan, such as those covering vehicle emissions, seat belts, and tires.)

EMISSION DEFECTS WARRANTY

Nissan¹ warrants that your vehicle was designed, built and equipped to conform at the time of sale with all applicable United States emission standards.

This warranty covers any repairs needed to correct defects in materials or workmanship which would cause your vehicle not to meet these standards.

WHAT IS COVERED UNDER THE DEFECTS WARRANTY

Covered components are listed below under the caption "WARRANTY PARTS LIST." Exceptions to this warranty are listed below under the caption "WHAT IS NOT COVERED UNDER EITHER THE DEFECTS OR PERFORMANCE WARRANTIES."

HOW LONG IS THE DEFECTS WARRANTY

This warranty is for 3 years or 36,000 miles, whichever occurs first. The warranty begins the date the vehicle is delivered to the first retail buyer or put into use, whichever is earlier. Additionally, the engine control module/onboard diagnostic device and catalytic converter(s) listed below and indicated by an "O" under the caption "Warranty Parts List" are covered for 8 years or 80,000 miles, whichever occurs first.

EMISSIONS PERFORMANCE WARRANTY WHEN DOES THIS WARRANTY APPLY

The Emission Performance warranty applies to your 2008 Nissan vehicle ONLY when both of the following occur.

1. The vehicle fails to meet applicable emissions standards as judged by an emissions test approved by the Environmental Protection Agency (EPA).

2. This failure results or will result in some penalty to you, such as a monetary fine or the denial of the right to use your vehicle, under local, state or federal law.

For example, if your state requires an EPA approved yearly vehicle inspection before you receive a renewed license, this warranty applies to your vehicle. In areas where there is no approved test program, this warranty does not apply.

WHAT IS COVERED AND FOR HOW LONG UNDER THE PERFORMANCE WARRANTY

Nissan¹ warrants that it will remedy any non-conformity in your vehicle which causes it to fail an approved emissions test during the first 24 months or 24,000 miles, whichever occurs first. This warranty begins the date the vehicle is delivered to the first retail buyer or put in to use, whichever is earlier.

Additionally, failure of an approved emissions test resulting from the failure of those parts listed below under the caption "Warranty Parts List" are covered by the Emissions Defects Warranty described above.

Exceptions to this warranty are listed below under the caption "WHAT IS NOT COVERED UNDER EITHER THE DEFECTS OR PERFORMANCE WARRANTIES."

LIMITATION OF WARRANTIES AND OTHER WARRANTY TERMS AND STATE LAW RIGHTS**EXTRA EXPENSES - LIMITATIONS OF DAMAGES**

These emissions warranties do not cover incidental or consequential damages such as loss of the use of the vehicle, inconvenience or commercial loss.

ANY IMPLIED WARRANTY OF MERCHANTABILITY AND FITNESS FOR A PARTICULAR PURPOSE SHALL BE LIMITED TO THE DURATION OF THESE WRITTEN WARRANTIES.

Some states do not allow the exclusion or limitation of incidental or consequential damages or limitations on how long an implied warranty lasts, so the above limitations or exclusions may not apply to you. These warranties give you specific legal rights, and you may also have other rights which vary from state to state.

Nissan does not authorize any person to create for it any other warranty, obligation or liability in connection with this vehicle.

(Continued on page 8)

¹ Nissan indicates Nissan North America, Inc., P.O. Box 685003, Franklin, TN 37068-5003 which distributes Nissan vehicles in the United States.

WHAT IS NOT COVERED UNDER EITHER THE DEFECTS OR PERFORMANCE WARRANTIES

These warranties do not cover:

1. Normal maintenance, service and parts replacement as outlined in the emissions control maintenance instructions of your OWNER'S MANUAL and your NISSAN SERVICE & MAINTENANCE GUIDE.
2. Failures directly as a result of:
 - Failure to perform required emission control maintenance as outlined in your OWNER'S MANUAL and your NISSAN SERVICE & MAINTENANCE GUIDE.
 - Misuse, accident or modification.
 - Improper adjustment or installation of parts during the performance of maintenance services.
 - Tampering with or disconnecting any part affecting vehicle emissions.
 - The use of contaminated fuel or fuel other than that specified in your OWNER'S MANUAL.
3. In the case of the Performance Warranty, the use of any part not certified in accordance with Federal requirements which is defective or not equivalent from an emissions standpoint to the original equipment part.
4. In the case of the Performance Warranty, costs of determining the cause of a vehicle failing an EPA approved emissions test if such failure is found not to be covered.
5. In the case of the Defects Warranty, parts not supplied by Nissan or damage to other parts caused directly by non-Nissan parts.

WHAT YOU MUST DO

In order to obtain warranty service you must deliver the vehicle to an authorized Nissan dealer in the United States at your expense.

You must also maintain your vehicle as outlined in the maintenance instructions in your NISSAN SERVICE & MAINTENANCE GUIDE.

WHAT NISSAN WILL DO

Warranty repairs will be made at no charge for parts and/or labor, including diagnosis and tax. Any needed parts replacement will be made using new or remanufactured parts.

OTHER WARRANTY TERMS PERFORMANCE WARRANTY CLAIMS PROCEDURE

You may make a claim under the Performance Warranty immediately after the failure of an EPA approved emissions test. You must provide proof of this failure when making your claim.

You will be told whether Nissan will honor your claim within 30 days of the date you make the claim unless a shorter time period is required by law. If your claim is denied, Nissan will notify you in writing of the reason. If we do not notify you within this time period, we will repair your vehicle under this warranty at no cost to you. The time period for notification will not apply if you request a delay or a delay is caused by events not under the control of Nissan dealers.

No claim will be denied under the Performance Warranty

because you use a non-Nissan but EPA certified part for maintenance or repair.

MAINTENANCE SERVICE AND REPLACEMENT PARTS

Important information concerning maintenance service and replacement parts is in the Limited Warranty on Nissan Parts and Accessories section of this booklet.

MAINTENANCE RECORDS

Receipts covering the performance of regular maintenance should be kept in the event questions arise concerning maintenance. The receipts should be transferred to subsequent owners.

IF YOU HAVE QUESTIONS

You may obtain further information concerning these warranties by following the procedure outlined in the "CUSTOMER CARE" section of this booklet. In the case of the Performance Warranty, you may also contact or report any violations to the Office of Transportation and Air Quality, Vehicle Compliance Programs Group, U.S. Environmental Protection Agency, Ariel Rios Building (6405J), 1200 Pennsylvania Avenue, N.W, Washington, D.C. 20460

(Continued on page 9)

WARRANTY PARTS LIST

- Fuel injection system
- Engine control module/onboard diagnostic device
 - Oxygen sensor(s)
 - Mass air flow sensor
 - Intake manifold
 - Throttle body
- Catalytic converter(s)
 - Exhaust manifold(s)
 - Exhaust tube from manifold to catalytic converter
- Front exhaust tube with catalytic converter permanently attached
 - Camshaft position sensor(s)
 - Crankshaft position sensor(s)
 - Spark plugs, ignition coil and wires
 - Ignition control moduler
- Exhaust manifold with catalytic converter permanently attached
 - Evaporative emission control system
 - Fuel filler neck restrictor and check valve
 - Fuel tank and filler cap
 - Idle air control system
 - Positive crankcase ventilation system
 - Exhaust gas recirculation (EGR) control system
 - Pulsed secondary air injection system and valves
 - Hoses, clamps, fittings, tubing, sealing gaskets or devices and mounting hardware used in above systems
 - Vacuum and temperature sensitive valves and switches used in above systems
 - Electronic sensors and controls used in above systems

The Emission Performance or Defect Warranty may be subject to future governmental administrative action. Nissan reserves the right to change the terms of the warranty to be consistent with these actions. See your dealer for information regarding possible changes.

The following statement is required to be provided by regulations of the California Air Resources Board.

YOUR WARRANTY RIGHTS AND OBLIGATIONS

The California Air Resources Board is pleased to explain the emission control system warranty on your 2008 vehicle.³ In California, new motor vehicles must be designed, built and equipped to meet the State's stringent anti-smog standards. Nissan⁴ must warrant the emission control system on your vehicle for the periods of time listed below provided there has been no abuse, neglect or improper maintenance of your vehicle.

Your emission control system may include parts such as the fuel-injection system, the ignition system, catalytic converter and engine computer. Also included may be hoses, belts, connectors and other emission-related assemblies.

Where a warrantable condition exists, Nissan will repair your vehicle at no cost to you including diagnosis, parts and labor.

MANUFACTURER'S WARRANTY COVERAGE⁵

For 3 years or 50,000 miles (whichever occurs first):

- 1) If your vehicle fails a Smog Check inspection, all necessary repairs and adjustments will be made by Nissan to ensure that your vehicle passes the inspection. This is your emission control system

PERFORMANCE WARRANTY.

- 2) If any emission-related part on your vehicle is defective, the part will be repaired or replaced by Nissan. This is your short-term emission control system DEFECTS WARRANTY.

For 7 years or 70,000 miles (whichever occurs first):

If an emission-related part listed in this warranty booklet specially noted with coverage for 7 years or 70,000 miles is defective, the part will be repaired or replaced by Nissan. This is your long-term emission control system DEFECTS WARRANTY.

OWNER'S WARRANTY RESPONSIBILITIES

As the vehicle owner, you are responsible for the performance of the required maintenance listed in your owner's manual. Nissan recommends that you retain all receipts covering maintenance on your vehicle, but Nissan cannot deny warranty solely for the lack of receipts or for your failure to ensure the performance of all scheduled maintenance.

You are responsible for presenting your vehicle to a Nissan dealer as soon as a problem exists. The warranty repairs should be completed in a reasonable amount of time, not to exceed 30 days.

As the vehicle owner, you should also be aware that Nissan may deny you warranty coverage if your vehicle or a part has failed due to abuse, neglect, improper maintenance or unapproved modifications.

If you have any questions regarding your warranty rights and responsibilities, you should contact Nissan's Consumer Affairs Department at 1-800-NISSAN-1 (1-800-647-7261) or the California Air Resources Board at 9528 Telstar Avenue, El Monte CA 91731.

(Continued on page 11)

¹ These warranties apply to all California and 50-state emission equipped 2008 model year Nissan vehicles sold for registration as new vehicles in California, Maine, Massachusetts, Connecticut, Pennsylvania, Rhode Island, or Vermont only.

² These warranties additionally apply to all Model Year 2008 Zero Emissions Vehicles (ZEVs) and Partial Zero Emissions Vehicles (PZEVs) sold in the states of New York and New Jersey.

³ Throughout this Limited Emission Control Warranty, "vehicle" means a Nissan model vehicle.

⁴ Nissan indicates Nissan North America, Inc., P.O. Box 685003, Franklin, TN 37068-5003 which distributes Nissan vehicles in the United States.

⁵ The performance and defect warranty coverage for the California Emission Altima with 2.5 engine ONLY is 15 years/150,000 miles, whichever occurs first.

The following is Nissan's new vehicle emission control warranty statement for vehicles certified for sale in California and sold for registration as a new vehicle in California, Maine, Massachusetts, or Vermont only*.

LIMITATION OF WARRANTIES AND OTHER WARRANTY TERMS AND STATE LAW RIGHTS

EXTRA EXPENSES - LIMITATIONS OF DAMAGES
These emissions warranties do not cover incidental or consequential damages such as loss of the use of the vehicle, inconvenience or commercial loss.

ANY IMPLIED WARRANTY OF MERCHANTABILITY AND FITNESS FOR A PARTICULAR PURPOSE SHALL BE LIMITED TO THE DURATION OF THESE WRITTEN WARRANTIES.

Some states do not allow the exclusion or limitation of incidental or consequential damages or limitations on how long an implied warranty lasts, so the above limitations or exclusions may not apply to you. These warranties give you specific legal rights, and you may also have other rights which vary from state to state.

Nissan does not authorize any person to create for it any other warranty, obligation or liability in connection with this vehicle.

EMISSIONS DEFECTS WARRANTY

WHAT IS COVERED

Nissan warrants that your vehicle was designed, built and equipped to conform with all applicable requirements of the California Air Resources Board. This warranty covers any part which affects applicable regulated emission(s).

Exceptions to this warranty are listed below under the caption "WHAT IS NOT COVERED."

HOW LONG IS THE WARRANTY⁵

This warranty is for 3 years or 50,000 miles, whichever occurs first. Additionally, the components listed under the caption "Long-Term Emission System Defects Warranty Parts List" are covered for 7 years or 70,000 miles, whichever occurs first, except that the catalytic converter and engine control module (ECM) are warranted for 8 years or 80,000 miles, whichever occurs first. The warranty begins the date the vehicle is delivered to the first retail buyer or put into use, whichever is earlier.

Some items require scheduled replacement before 50,000 miles. These items are warranted only up to the replacement interval. The replacement intervals are outlined in the maintenance instructions in your NISSAN SERVICE & MAINTENANCE GUIDE.

LONG-TERM EMISSION SYSTEM DEFECTS WARRANTY PARTS LIST

- Engine control module (all models).
- Catalytic converter(s) (Altima w/3.5 engine, Maxima, 350Z, Quest, Murano, Frontier w/4.0 engine, Xterra, Pathfinder).
- Intake manifold (Versa, Sentra, 350Z, Murano, Frontier w/2.5 engine).
- Intake manifold collector (Murano, Altima w/3.5 engine).
- Exhaust manifold (Versa, Sentra, Maxima rear only, 350Z, Frontier w/4.0 engine RH only, Xterra RH only, Pathfinder RH only).
- Exhaust manifold with catalytic converter (Titan, Armada, Frontier w/2.5 engine, Pathfinder w/5.6 engine, Sentra w/2.5 engine, Rogue).
- Front exhaust tube (350Z).
- Front exhaust tube with catalytic converter (Versa, Sentra, Altima w/3.5 engine, Murano, Pathfinder, Rogue).

- Throttle body (Versa, Sentra, Altima w/3.5 engine, Maxima, 350Z, Quest, Murano, Frontier, Xterra, Pathfinder, Titan, Armada, Rogue).
- Mass air flow sensor (Maxima, Quest, Murano, Sentra w/2.5 engine, Rogue).
- EGI wiring harness (Versa, Sentra, Rogue, Altima w/3.5 engine, 350Z, Murano, 2WD Titan).
- Fuel tank (Altima w/3.5 engine, Maxima, 350Z, Quest, Murano, Frontier, Xterra, Pathfinder, Titan, Armada, Versa, Sentra, Rogue).
- Flywheel (Versa, Sentra, Altima w/3.5 engine, 350Z, Frontier, Xterra).
- Torque converter drive plate (Versa, Sentra, Altima w/3.5 engine, Maxima, 350Z, Quest, Murano, Frontier, Xterra, Pathfinder).
- Automatic transmission control module (Versa, Sentra, Altima w/3.5 engine, Maxima, Quest, Murano, Rogue).
- Air fuel ratio sensor (Murano).
- Knock Sensor (Frontier w/4.0 engine, Xterra, Pathfinder, 350Z).

EMISSIONS PERFORMANCE WARRANTY WHEN DOES THIS WARRANTY APPLY

This warranty applies to your 2008 Nissan vehicle only if it fails to pass a California "smog check" test or equivalent.

WHAT IS COVERED AND FOR HOW LONG⁵

Nissan* warrants that if your vehicle fails to pass a California "smog check" test, it will make the necessary repairs so that your vehicle will pass. This warranty is for 3 years or 50,000 miles, whichever occurs first. The warranty begins the date the vehicle is delivered to the first retail buyer or the date it is first put in to service, whichever is earlier.

Exceptions to this warranty are listed under the caption "WHAT IS NOT COVERED".

(Continued on page 12)

- = Long Term Federal Emission Parts covered for 96 months/or 80,000 miles.

WHAT IS NOT COVERED

These warranties do not cover:

1. Normal maintenance, service and parts replacement as outlined in the emission control maintenance instructions of your OWNER'S MANUAL and your NISSAN SERVICE & MAINTENANCE GUIDE.
2. Failures directly as a result of:
 - Lack of performance of required emission control maintenance as outlined in your OWNER'S MANUAL and your NISSAN SERVICE & MAINTENANCE GUIDE.
 - Misuse, accident or modification.
 - Improper adjustment or installation of parts during the performance of maintenance (non-warranty) services.
 - Tampering with or disconnecting any part affecting vehicle emissions.
 - The use of fuel other than that specified in your OWNER'S MANUAL or fuel with contaminants which the fuel filter is not designed to remove.
3. In the case of the Performance Warranty, the use of any non-Nissan part not certified in accordance with Federal requirements which is defective or not equivalent from an emissions stand point to the original equipment part.
4. In the case of the Defects Warranty, parts not supplied by Nissan or damage to other parts caused directly by non-Nissan parts.
5. In the case of the Performance Warranty, costs of determining the cause of a vehicle failing a California "smog check" test if such failure is found not to be covered.

WHAT YOU MUST DO

In order to obtain warranty service you must deliver the vehicle to any authorized Nissan dealer in the United States at your expense. You are responsible for the required maintenance on your vehicle as outlined in the maintenance instructions in your NISSAN SERVICE & MAINTENANCE GUIDE. Nissan recommends that you retain all receipts covering maintenance on your vehicle, but Nissan cannot deny warranty solely for the lack of receipts or for your failure to ensure the performance of all scheduled maintenance.

WHAT NISSAN WILL DO

Warranty repairs will be made at no charge for parts and/or labor, including diagnosis and tax. Any needed parts re-placement will be made using new or remanufactured parts.

OTHER WARRANTY TERMS**Performance Warranty Claims Procedure**

You may make a claim under the Performance Warranty immediately after the failure of a "smog check" test. You must provide proof of this failure when making your claim in order to avoid additional "smog check" test charges.

You will be told whether Nissan will honor your claim within 30 days of the date you make the claim, unless a shorter time period is required by law. If your claim is denied, Nissan will notify you in writing of the reason. If we do not notify you within this time period, we will repair your vehicle under this warranty at no cost to you. The time period for notification will not apply if you request a delay or a delay is caused by events not under the control of Nissan dealers. No claim will be denied under the Performance Warranty because you use a certified part for maintenance or repair.

Maintenance Service and Replacement Parts

Important information concerning maintenance service and replacement parts is in the Limited Warranty on Nissan Replacement Parts and Accessories section of this booklet. No warranty claim will be denied solely because a non-Nissan part was used for maintenance or repair.

California Vehicle Inspection Program

Under this program, if your vehicle fails a "smog check" test, you may choose to have diagnosis of the failure and repairs made at a Nissan dealer or at another service facility. If the inspection failure is the result of a condition covered by these warranties, you must take your vehicle to an authorized Nissan dealer for warranty repairs. This includes parts, labor and diagnosis. You must pay for diagnostic costs if performed at another service facility except in the case of emergency repairs as outlined below.

You must pay for all diagnostic and repair costs of an inspection failure as required by law if the failure was caused by conditions not covered by these warranties. If the failure is the result of a combination of conditions, you must pay for only the diagnostic and repair costs related to items not covered by these warranties.

After the 3 year/50,000 mile performance warranty has passed, a "smog check" test failure due to a defect in a part which is warranted for 7 years/70,000 miles is covered.⁵

Emergency Repairs

In case of an emergency, when an authorized Nissan dealer is not reasonably available, warranty repairs may be performed at any service facility or by the owner using any replacement parts. Nissan will reimburse you for such repairs, including diagnosis, up to the amount of Nissan's suggested retail price for parts and labor charges based on Nissan's recommended time allowance for the warranty repair and the geographically appropriate hourly labor rate. A part not being available or a repair not being complete within 30 days also constitutes an emergency.

(Continued on page 13)

You must take the replaced part and paid receipts to an authorized Nissan dealer for repayment in such emergency situations.

Maintenance Records

Receipts covering the performance of regular maintenance are not required but should be kept in the event questions arise concerning maintenance. The receipts should be transferred to subsequent owners.

If you have Questions

You may obtain further information concerning these warranties by following the procedure outlined in the "CUSTOMER CARE" section of this booklet. You may also contact or report any violations to the Office of Transportation and Air Quality, Vehicle Compliance Programs Group, U.S. Environmental Protection Agency, Ariel Rios Building (6405J), 1200 Pennsylvania Avenue, N.W, Washington, D.C. 20460 or the Chief, Mobile Source Division, Air Resources Board, 9528 Telstar Ave., El Monte, CA. 91731.

Other Obligations

Nissan does not authorize any person to create for it any other warranty, obligation or liability in connection with this vehicle.

Warranty for 2008 vehicles certified for sale in California may be subject to future governmental administrative or judicial action. As a result, this warranty may be changed because Nissan reserves the right to, and, will make those changes required by future law, regulation, or judicial or administrative action in order to be consistent with such governmental actions.

WHO IS THE WARRANTOR

Nissan* warrants all parts of your 2008 Nissan vehicle seat belt system supplied by Nissan.

*Nissan indicates Nissan North America, Inc., P.O. Box 685003, Franklin, TN 37068-5003, which distributes Nissan vehicles in the United States.

WHAT IS COVERED AND FOR HOW LONG

This warranty covers any Nissan supplied seat belt or related component, that fails to function properly during normal use within ten (10) years of the date the vehicle is delivered to the first retail buyer or put into service, whichever is earlier. Warranty repairs are free of charge for parts and labor.

OBTAINING WARRANTY SERVICE

You must take the vehicle to an authorized Nissan dealer in the United States or Canada during regular business hours at your expense in order to obtain warranty service. The names and addresses of authorized Nissan dealers are listed in telephone directories.

WHAT IS NOT COVERED

- Damage or failure due to misuse, alteration, accident or collision damage. (Proper use is outlined in your OWNER'S MANUAL).
- Color fading, spotting or other cosmetic items when the belt is otherwise functioning properly.
- Air bags and related electronic control systems which are covered by the Powertrain warranty.

LIMITATION OF WARRANTIES AND OTHER WARRANTY TERMS AND STATE LAW RIGHTS

EXTRA EXPENSES - LIMITATIONS OF DAMAGES

This warranty does not cover incidental or consequential damages such as loss of the use of the vehicle, inconvenience or commercial loss.

ANY IMPLIED WARRANTY OF MERCHANTABILITY AND FITNESS FOR A PARTICULAR PURPOSE SHALL BE LIMITED TO THE DURATION OF THIS WRITTEN WARRANTY.

Some states do not allow the exclusion or limitation of incidental or consequential damages or limitations on how long an implied warranty lasts, so the above limitations or exclusions may not apply to you. This warranty gives you specific legal rights, and you may also have other rights which vary from state to state.

Nissan does not authorize any person to create for it any other warranty, obligation or liability in connection with this vehicle.

WHO IS COVERED

The owner of a BFGoodrich Passenger or Light Truck tire which bears the BFGoodrich name and complete DOT identification number.

WHAT IS COVERED AND FOR HOW LONG

BFGoodrich Passenger and Light Truck tires, used in normal service on the vehicle on which they were originally fitted and in accordance with the maintenance recommendations and safety warnings contained in the owner's manual and in the Important Tire Safety Information Section of this booklet, are covered by this warranty against defects in workmanship and material for the life of the original usable tread, or 6 years from the date of purchase, whichever comes first. At that time, all warranties, express or implied, are terminated. The usable tread is the original tread down to the level of the tread wear indicators - 2/32nds of an inch (1.6mm) of tread remaining. Date of purchase is documented by new vehicle registration or tire sales invoice. If no proof of purchase, coverage will be based on date of manufacture.

WHAT IS NOT COVERED

Tires which become unserviceable due to:

- Road hazard injury (e.g., a cut, snag, bruise, impact damage, puncture, whether repairable or not);
- Incorrect mounting of the tire, tire/wheel imbalance, or improper repair;
- Underinflation, overinflation, improper maintenance or other abuse;
- Mechanical irregularity in the vehicle such as wheel misalignment resulting in uneven or rapid wear;
- Accident, fire, chemical corrosion, tire alteration, or vandalism;
- Ozone or weather cracking.

WHAT BFGOODRICH WILL DO**PASSENGER AND LIGHT TRUCK TIRES**

A tire which becomes unserviceable due to a condition covered by this warranty will be replaced with a comparable new BFGoodrich tire, free of charge, when 2/32nds of an inch (1.6mm) or less of the original tread is worn, (or 25% or less, whichever is most beneficial to the user) and within 12 months of the date of purchase. Mounting and balancing of tires is included. The cost of any other service charges and applicable taxes are payable by the user.

When more than 2/32nds of an inch of original tread has been worn (or more than 25%, whichever is most beneficial to the user) or after 12 months from date of purchase, the user must pay the cost of a comparable new BFGoodrich passenger or light truck replacement tire on a *pro rata* basis. The dealer shall determine the charge by multiplying the percentage of the original usable tread worn by the current actual selling price at the adjustment location or the price on the current BFGoodrich Brand Base Price List, whichever is lower. This List is based on a predetermined price intended to fairly represent the actual selling price of the tire. The cost of mounting, balancing and any other service charges and applicable taxes are payable by the user.

(Continued on page 16)

WHAT THE CONSUMER MUST DO

When making a claim under the terms of this warranty, the consumer must present the tire to an authorized BFGoodrich Dealer. To locate an Authorized Tire Dealer, check the yellow pages under "Tire Dealers - Retail."

The vehicle on which the tire was used should be available for inspection.

It is essential that you read and understand the safety and maintenance recommendations (see Safety Maintenance Information) for your tires.

CONDITIONS AND EXCLUSIONS

THIS WARRANTY DOES NOT PROVIDE COMPENSATION FOR LOSS OF TIME, LOSS OF USE OF VEHICLE, INCONVENIENCE OR CONSEQUENTIAL DAMAGE.

TIRES PRESENTED FOR CLAIM REMAIN THE PROPERTY OF THE CONSUMER AND BFGOODRICH BRAND ACCEPTS NO RESPONSIBILITY FOR LOSS OF, OR DAMAGE TO, TIRES WHICH ARE IN THE CUSTODY OR CONTROL OF A BFGOODRICH TIRE DEALER FOR THE PURPOSE OF INSPECTION FOR WARRANTY ADJUSTMENT. IN THE EVENT OF A DISPUTED CLAIM, THE CONSUMER MUST MAKE THE TIRE AVAILABLE FOR FURTHER INSPECTION.

NO BFGOODRICH REPRESENTATIVE, EMPLOYEE OR DEALER HAS THE AUTHORITY TO MAKE OR IMPLY ANY REPRESENTATION, PROMISE OR AGREEMENT, WHICH IN ANY WAY VARIES THE TERMS OF THIS WARRANTY.

THIS WARRANTY APPLIES ONLY IN THE UNITED STATES AND CANADA.

CONSUMER RIGHTS

THIS WARRANTY GIVES YOU SPECIFIC LEGAL RIGHTS, AND YOU MAY ALSO HAVE OTHER RIGHTS WHICH VARY FROM STATE TO STATE AND PROVINCE TO PROVINCE.

SAFETY MAINTENANCE INFORMATION

Read your vehicle owners manual, the information on the sidewall of your tires, the vehicle tire information placard and the Important Tire Safety Information section of this booklet for essential safety and maintenance information.

THE WARRANTOR

The warrantor of BFGoodrich Tires is Michelin North America, Inc. 1 Parkway South, P.O. Box 19001, Greenville, South Carolina 29602-9001.

For Consumer Assistance, Please Call Toll Free:
1-877-788-8899

Or Write:

Consumer Relations

P.O. Box 19026, Greenville, SC 29602-9026

DANGER

Disregarding any of the safety precautions and instructions contained in the Owner's Manual or the Important Tire Safety Information in this booklet may result in tire failure or explosion causing serious personal injury or death.

ELIGIBILITY

You are covered under the terms of this warranty if you are the first retail purchaser or authorized agent of the first retail purchaser of any new Bridgestone or Firestone tire bearing the Bridgestone or Firestone name and Department of Transportation (DOT) assigned identification number, produced after July 3, 1994 (274), and if your tire has been used only on the vehicle on which it was originally installed in non-commercial service and is of a size equivalent to or greater than that specified by the vehicle's manufacturer.

WHAT THIS WARRANTY COVERS & FOR HOW LONG

If, (i) before wearing down to 2/32nds of an inch of tread depth remaining (i.e., worn down to the top of the built-in indicators in the tread grooves), (ii) before 6 years from the date of purchase (proof of purchase required), or (iii) before 6 years from the date of manufacture (whichever occurs first), any Bridgestone or Firestone tire covered by this warranty becomes unusable for any reason within the manufacturer's control, such tire will be replaced with an equivalent Bridgestone or Firestone tire on the basis set forth below.

WHAT THE WARRANTY DOES NOT COVER

1. Tire damage or irregular wear due to:

A. Road Hazards.

Including, without limitation, puncture, cut, impact break, bruise, bulge, snag, etc.

B. Continued use while run flat or under acute under-inflation.**C. Improper Use or Operation.**

Including, without limitation, improper inflation pressure, overloading, use of an improper rim, vehicle misalignment, tire/wheel assembly imbalance or other vehicle conditions, worn suspension components, improper mounting or demounting, misuse, misapplication, negligence, tire spinning, tire chain damage, chemical contamination, fire or other externally generated heat, water or other material trapped inside the tire during mounting, tire alteration, racing or competition purposes, improper insertion of sealant, balance or filler materials.

D. Improper Repair.

2. Ride disturbance claims submitted after 1/32nd inch of treadwear or for 4 or more tires from the same vehicle.
3. The cost of applicable federal, state, and local taxes.
4. Tires purchased and normally used outside the continental United States.
5. Claims for weather/ozone cracking after 4 years from the date of purchase (proof of purchase required) or if not known, 4 years from the date of manufacture.
6. Failure to observe any of the safety and maintenance precautions contained in the "Important Tire Safety Information" section of this booklet.

This warranty is in addition to and/or may be limited by any other applicable written warranty concerning special tires or situations you may have received.

"LIMITED WARRANTY" Bridgestone and Firestone Brand Passenger & Light Truck Tires**REPLACEMENT PRICE**

Radial passenger and light truck tires adjusted under this warranty will be replaced free of charge during the first 25% of treadwear or within the first 12 months after purchase (Proof of Purchase and Purchase Date are required), whichever occurs first.

During the free replacement period, mounting and balancing are included free of charge.

After the free replacement period, to determine the replacement price, the percent of used treadwear is multiplied by the owner-user's regular buying price. Taxes, mounting, balancing, and other service charges will be added to the adjustment replacement price.

IN CANADA, the tire will be adjusted at dealerships (subject always to dealer discretion) at a predetermined "Adjustment Price".

Replacement Warranty. If you receive a tire under this warranty, it will be covered by the warranty then given on that tire.

Where to go. See your Bridgestone or Firestone retailer listed in Yellow Pages under Tire Dealers-Retail.

CONSUMER RIGHTS

This warranty gives you specific legal rights, and you may also have other rights which vary from state to state and in Canada from province to province.

(Continued on page 18)

CONDITIONS & EXCLUSIONS

TO THE EXTENT PERMITTED BY LAW, BRIDGESTONE/FIRESTONE, INC. DISCLAIMS LIABILITY FOR ANY CONSEQUENTIAL DAMAGES, LOSS OF TIME, OR LOSS OF VEHICLE USE, OR INCONVENIENCE.

Some states do not allow the exclusion or limitation of incidental or consequential damages, so the above limitation or exclusion may not apply to you.

This warranty applies only to consumers actually using the tire in the United States and Canada. For warranty conditions outside the United States and Canada, see your local Bridgestone or Firestone distributor.

Obligations under this policy may not be enlarged or altered by anyone.

Important: In accordance with Federal Law, this warranty has been designated as a "Limited Warranty". Nothing in this warranty is intended to be a representation that tire failures cannot occur. This warranty is given by Bridgestone/Firestone, Inc., One Bridgestone Park, Nashville, TN 37214 and in Canada by Bridgestone Canada, Inc., 5770 Hurontario St. Suite 400, Mississauga, Ontario, Canada L5R 3G5.

OWNER-USER'S OBLIGATION

It is owner-user's obligation to operate tires within tire load and specification limits and at cold air pressures

specified by your vehicle manufacturer for load and speed according to individual tire size, type, and load capacity. It is also the owner-user's obligation to maintain proper alignment of wheels, and to maintain proper tire/wheel assembly balance.

In case of adjustment claim, owner-user must present the tire to a Bridgestone or Firestone retailer, complete and sign the customer section of the Bridgestone/Firestone, Inc. warranty claim form, and pay appropriate replacement price, taxes and service charges.

We strongly recommend that you have your Bridgestone or Firestone retailer inspect tires any time you notice irregular or uneven treadwear or every 5,000 miles or at vehicle manufacturer's recommended mileage, if sooner.

Note: For your convenience, your nearest authorized Nissan Dealership will also assist you with your Tire Service Requirements or in obtaining tire warranty service from the tire manufacturer.

THE WARRANTOR

The warrantor of Bridgestone and Firestone tires is: Bridgestone/Firestone, Inc., ATTN: Technical Services, One Bridgestone Park, Nashville, TN 37214.

For Customer Assistance:
1-800-847-3272

SAFETY INFORMATION

Any tire, no matter how well constructed, may fail in use as a result of punctures, impact damage, improper inflation, overloading, or other conditions resulting from use or misuse. Tire failure may create a risk of serious personal injury or property damage. To reduce risk of tire failure, we strongly recommend you read and follow all safety information contained in the Important Tire Safety Information section contained in this booklet, the tire placard in the vehicle or the Owner's Manual.

WHO IS ELIGIBLE?

You are eligible for the benefits of this Limited Warranty if:

- You are the owner or authorized agent of the owner of new Dunlop highway auto, light truck or temporary spare tires supplied as original equipment on your vehicle, and
- Your tires bear Department of Transportation prescribed tire identification numbers and your tires have been used only on the vehicle on which they were originally installed according to the vehicle manufacturer or Dunlop recommendations, and
- Your vehicle was purchased on or after March 1, 2003.

WHAT IS COVERED AND FOR HOW LONG?**FREE TIRE REPLACEMENT**

Any Dunlop tire eligible under the provisions of this limited warranty and removed from service due to a covered warranty condition during the first 2/32" treadwear or 12 months from date of purchase, whichever occurs first, will be replaced with a comparable new Dunlop tire at no charge. Mounting and balancing are included. (Without proof of purchase, date of manufacture will be used to determine age.)

TEMPORARY SPARE TIRES

Any Dunlop temporary spare tire eligible under the provisions of this limited warranty and removed from service due to a covered warranty condition during the first 50 percent of usable treadwear will be replaced with a comparable new Dunlop temporary spare tire at no charge, including mounting.

PRORATED ADJUSTMENT

A tire not eligible for no-charge replacement that is removed from service due to a covered warranty condition will be replaced with a comparable new Dunlop tire on a prorated basis.

HOW WILL PRORATED CHARGES BE CALCULATED?

Replacement price will be calculated by multiplying the tire's advertised retail selling price at the time of adjustment by the percentage of usable original tread that has been worn off. You pay for mounting, balancing and applicable taxes.

Example: If your disabled tire had an original 8/32" of usable treadwear and is worn to 4/32" usable tread remaining, you have used 50 percent and, therefore, must pay 50 percent of the current advertised selling price of the replacement tire. If the price of the new replacement tire is \$80, the cost to you would be \$40 plus any additional charges such as mounting, balancing and applicable taxes.

WHAT IS A COMPARABLE TIRE?

A comparable new Dunlop tire may either be the same line of tire or, in the event that the tire is not available, a tire of the same basic construction and quality with a different side-wall or tread configuration. If a higher priced tire is accepted as replacement, the difference in price will be at an additional charge to you.

ADDITIONAL PROVISIONS

A tire has delivered its full original treadlife and the coverage of this warranty ends when the treadwear indicators become visible (worn to 2/32"), or six (6) years from the date of original tire manufacture or new tire purchase date. (Without proof of purchase, date of manufacture will be used to determine age.)

Any replacement tire provided pursuant to this warranty will be covered by the Dunlop warranty in effect at the time of replacement.

LIMITATIONS

This limited warranty is applicable only in the United States and Canada.

WHAT IS NOT COVERED BY THIS WARRANTY?

This limited warranty does not cover the following:

- Tires submitted for ride disturbance complaints that are worn beyond the first two thirty-seconds of an inch (2/32") tread depth.
- Dunlop does not warrant or give credit in any adjustment transaction for any kind of material added to a tire (e.g., tire fillers, sealants, balancing substances) after the tire leaves a factory producing Dunlop tires, nor will it adjust any tire that has failed as a result of adding such material.
- Irregular wear or damage due to mechanical condition of the vehicle, improper inflation, overloading, high speed spin-up, misapplication, misuse, negligence, racing, use of tire chains, improper mounting or demounting, improper repair, wreck, collision or fire.
- Road hazards (includes, but not limited to, punctures, cuts, snags, impact breaks, etc.).
- Any tire that after leaving a factory producing Dunlop tires has been intentionally altered to change its appearance (e.g., white inlay on a black tire, regrooving or siping).
- Tires with weather-cracking that were purchased more than four (4) years prior to presentation for adjustment or, if purchase date cannot be verified, manufactured more than four (4) years prior to presentation for adjustment.
- Loss of time, inconvenience, loss of vehicle use, incidental or consequential damages.

(Continued on page 20)

WHAT ARE YOUR LEGAL RIGHTS?

Some states and provinces do not allow the exclusion or limitation of incidental or consequential damages, so the above limitations or exclusions may not apply to you. No representative or dealer has authority to make any representation, promise, or agreement on behalf of Goodyear Dunlop Tires North America, Ltd. (GDTNA), except as stated herein.

Any tire, no matter how well constructed, may fail in service or otherwise become unserviceable due to conditions beyond the control of the manufacturer. Under no circumstances is this warranty a representation that a tire failure cannot occur.

This warranty gives you specific legal rights, and you may also have other rights that vary from state to state and in Canada province to province.

HOW DO YOU OBTAIN AN ADJUSTMENT?

- A. You must present the tire to be adjusted to an authorized Dunlop service facility. Tires replaced on an adjustment basis become the property of Goodyear Dunlop Tires North America, Ltd. or Goodyear Canada Inc.
- B. You must pay for taxes and any additional services you order at the time of adjustment.
- C. You must submit your claim on a GDTNA claim form supplied by an authorized Dunlop service facility. The form must be filled out completely and signed by you, the owner of the tire presented for adjustment, or your authorized agent.

TIRE CARE AND MAINTENANCE GUIDE

The easiest way to help ensure satisfactory mileage and performance from your Dunlop tires is to give them a simple but frequent inspection for proper inflation, even treadwear, and the presence of any damage.

DO MAINTAIN PROPER INFLATION PRESSURE IN YOUR TIRES

Proper inflation pressure is necessary for optimum tire performance, safety and fuel economy. To maintain proper inflation pressure, frequently check tires (when they are cool) with an accurate tire pressure gauge.*

For example, it is difficult to tell just by looking at radial tires whether they are underinflated. Furthermore, when operating a vehicle equipped with radial tires, it is difficult to notice when a tire has gone flat or nearly flat since the "feel" of the vehicle does not change significantly.

***Evidence of air loss or repeated underinflation always requires expert inspection to determine the source of leakage and tire removal to determine repairability.** To avoid injury, **NEVER** attempt to reinflate a tire that has been run severely underinflated.

Progressive air loss may result from punctures, cuts, curbing, impacts or partial bead unseating. Some fitment causes for air loss are (1) incomplete bead seating, (2) bead tearing caused by a machine tool due to insufficient lubrication or improper adjustment, (3) leaking valve core or rubber valve components. These should be replaced when problems are detected and whenever tires are replaced.

Always maintain inflation pressure at the level recommended by the vehicle manufacturer as shown on the vehicle placard or in the owner's manual:

Underinflation is the leading cause of tire failure and may result in severe cracking, component separation or "blowout." It reduces tire load capacity, allows excessive sidewall flexing and increases rolling resistance, resulting in heat and mechanical damage. Maintaining proper inflation pressure is the single most important thing you can do to ensure tire durability and maximum treadlife.

Overinflation increases stiffness, which may deteriorate ride and generate unwanted vibration. Overinflation also increases the chances of impact damage.

DON'T OVERLOAD YOUR VEHICLE

Check your vehicle owner's manual to determine the load limits. Overloading your vehicle places stress on your tires and other critical vehicle components. Overloading a vehicle can cause poor handling, increased fuel consumption and may cause tire failure.

Never fit your vehicle with new tires that have less load capacity than shown on the vehicle tire placard and remember that optimum rim width is important for proper tire load distribution and function.

The maximum load capacity stamped on the sidewalls of P-Metric tires is reduced by 10 percent when used on a light truck, utility vehicle or trailer. Never fit P-Metric tires to light trucks that specify LT-type replacement tires.

DON'T SPIN YOUR TIRES EXCESSIVELY

Avoid excessive tire spinning when your vehicle is stuck in snow, ice, mud or sand. The centrifugal forces generated by a free-spinning tire/wheel assembly may cause sudden tire explosion resulting in vehicle damage and/or serious

(Continued on page 21)

personal injury to you or a bystander. Never exceed 35 mph/60 km/h as indicated on your speedometer. Use a gentle backward and forward rocking motion to free your vehicle for continued driving. Never stand near or behind a tire spinning at high speed as, for example, while attempting to push a vehicle that is stuck or when an on-the-car spin balance machine is in use.

DO CHECK YOUR TIRES FOR WEAR

Always remove tires from service when they reach two thirty-seconds of an inch (2/32") remaining tread depth. All new tires have treadwear indicators which appear as smooth banks in the tread grooves when they wear to the two thirty-seconds of an inch (2/32") level. Many wet weather accidents result from skidding on bald or nearly bald tires. Excessively worn tires are also more susceptible to penetrations.

SIDEWALL TREATMENTS

Dunlop sidewalls are specially compounded to resist ozone cracking or weather-cracking.

Use a mild soap solution to clean sidewalls, white striping or lettering, and rinse off with plain water. Instruct service personnel and customers never to apply any other material to enhance sidewall appearance. These may degrade rubber and remove inherent ozone resistance.

DO CHECK YOUR TIRES FOR DAMAGE

Frequent inspection of your tires for signs of damage and their general condition is important for safety. If you have any questions, have your tire dealer inspect them. Impacts, penetrations, cracks, knots, bulges, or air loss always require tire removal and expert inspection. Never perform a temporary repair or use an innertube as a substitute for a proper repair. Only qualified persons should repair tires.

PROPER TIRE REPAIR

NOTE: Dunlop does not warrant any inspection or repair process. The repair is entirely the responsibility of the repairer and should be made in accordance with established Rubber Manufacturers Association (RMA) procedures.

DON'T ATTEMPT TO MOUNT YOUR OWN TIRES

Serious injury may result from explosion of tire/rim assembly due to improper mounting procedures. Follow tire manufacturer's instructions and match tire diameter to rim surfaces. Lock assembly on mounting machine or place in safety cage. **STAND BACK** and never exceed 40 psi to seat beads. Never use a volatile substance or a rubber "donut" (also known as a bead expander or "O-Ring") to aid bead seating. Only specially trained persons should mount tires.

DON'T MIX TIRES OF DIFFERENT SIZES AND TYPES ON THE SAME AXLE

For optimum handling and control, Dunlop recommends fitment of four (4) tires of the same type and size unless otherwise specified by the vehicle manufacturer.

FOLLOW THESE ADDITIONAL GUIDELINES:

Fit newest tires on rear axle. If radials and non-radials must be fitted to the same vehicle, fit radials on rear axle. Never mix radials and non-radials on the same axle. When fitting snow tires or all-season tires to performance vehicles, always fit in sets for four. Do not fit tires with different speed ratings.

Use of lift kits with some vehicle/tire combinations can cause instability. When changing tire sizes, always consult dealer for optimum rim width and carefully check vehicle/tire clearances.

RETREADED TIRES

Retreaded passenger and light truck tires are not warranted by Dunlop for any reason. Dunlop speed ratings and U.S. Department of Transportation test compliance certifications are voided for retreaded tires.

DO MAINTAIN VEHICLE SUSPENSION, WHEEL ALIGNMENT AND BALANCE AND ROTATE YOUR TIRES

Lack of rotation, worn suspension parts, underinflation/overinflation, wheel imbalance, and misalignment can cause vibration or irregular tire wear. Rotate your tires according to your vehicle manufacturer's recommendations or at maximum intervals of 6,000 miles/10,000 km.

LIGHTWEIGHT TEMPORARY SPARE TIRES IMPORTANT SAFETY INSTRUCTIONS

- Limit vehicle speed when using the lightweight temporary spare tire to 50 mph/80 km/h or less.
- Check the inflation pressure before using and at least weekly. Maintain cold tire pressure in accordance with that molded on the tire sidewall or found in your vehicle owner's manual. When inflating or adding air to lightweight temporary spare tire, be very careful, since the smaller tire volume can gain pressure quickly. Leave valve core in place and add inflation air in short bursts. Check the pressure often with an in-line or hand gauge until the specified pressure is reached.
- The lightweight temporary spare tire may lower ground clearance when used. Reduce speed and avoid driving over large obstacles or through chuckholes and other road hazards.
- Check your car owner's manual for other special clearance precautions when using the lightweight

(Continued on page 22)

temporary spare tire provided in your vehicle.

- Because your lightweight temporary spare tire was specifically designed for your car, it should not be used on any other vehicle.
- Do not use snow chains on your lightweight temporary spare tire. This could cause damage to your vehicle.
- Your lightweight temporary spare has very limited wear potential (up to 300 miles/500 km).
- In order to conserve tire treadlife, the lightweight temporary spare tire should be returned to your trunk as soon as the standard tire has been repaired or replaced. Never use the spare if treadwear indicator (TWI) bars are exposed or it is worn to the last 2/32" tread depth.
- Do not use your original equipment lightweight temporary spare tire on any other than its original equipment rim. The replacement lightweight temporary spare tire must match the original equipment tire removed from your lightweight temporary spare rim. Check the tire for the lightweight temporary spare tire size marking designation and compare size markings with those found on both your original lightweight temporary spare and rim.

NOTE: Your original equipment lightweight temporary spare tire and rim combination is not the same size as the other tires and rims with which your vehicle is equipped. Standard tires, snow tires, conventional wheel covers or rim rings should not be fitted to your lightweight temporary spare tire rim or assembly.

- Improper mounting can cause tire/rim assembly explosion and serious injury. Tire Fitters: Follow tire manufacturer's instructions and match tire diameter to rim diameter. Mount the lightweight temporary spare tire only on a rim originally fitted with a temporary spare of the same size. Lubricate beads and rim contact surfaces. Lock assembly on mounting machine or place in a safety cage. STAND BACK; inflate in short

bursts with extension hose, clip-on chuck on in-line gauge. Never exceed 40 psi to seat beads or use a volatile substance or a rubber "donut" to aid bead seating. Only specially trained persons should mount lightweight temporary spare tires.

Dunlop brand tires are serviced by The Goodyear Tire & Rubber Company and Goodyear Canada Inc. through authorized Dunlop outlets.

You must go to an authorized Dunlop outlet for replacement tires and all warranty service.

THE WARRANTOR

The warrantor of Dunlop tires is Goodyear/Dunlop N.A. Limited at 1144 East Market Street, Akron, Ohio 44136-0001

FOR SERVICE ASSISTANCE OR INFORMATION:

- FIRST CONTACT THE NEAREST DUNLOP RETAILER.
- IF ADDITIONAL ASSISTANCE IS REQUIRED:
IN THE UNITED STATES:
Call (800) 321-2136, or write:
Goodyear/Dunlop Consumer Relations
Dept. 728
1144 East Market Street, Akron, OH 44316-0001
IN CANADA:
Call (800) 387-3288, or write:
Goodyear/Dunlop Consumer Relations Department
450 Kipling Avenue
Toronto, Ontario M8Z 5E1

SAFETY WARNINGS

Serious injury or property damage may result from:

- TIRE FAILURE DUE TO UNDERINFLATION/OVERLOADING:
Follow the owner's manual, tire placard in vehicle, or Important Tire Safety Information located in this booklet.
- EXPLOSION OF TIRE/RIM ASSEMBLY DUE TO IMPROPER MOUNTING:
Only specially trained persons should mount tires.
- FAILURE TO MOUNT RADIAL TIRES ON APPROVED RIMS.
- FAILURE TO DEFLATE SINGLE OR DUAL ASSEMBLIES COMPLETELY BEFORE DEMOUNTING.
- TIRE SPINNING ON SLIPPERY SURFACES SUCH AS SNOW, MUD, ICE, ETC. DO NOT SPIN TIRES IN EXCESS OF 35 MPH (55 KPH), AS INDICATED ON THE SPEEDOMETER. PERSONAL INJURY AND SEVERE DAMAGE MAY RESULT FROM EXCESSIVE WHEEL SPINNING, INCLUDING TIRE DISINTEGRATION OR AXLE FAILURE.

GENERAL TIRE LIMITED WARRANTY AND ADJUSTMENT POLICY

This Limited Warranty and Adjustment (the "Policy") is issued by Continental Tire North America, Inc. (the "Company") and is applicable for General-brand original equipment tires and is a promise of replacement under certain specified conditions. This Policy applies to tires in normal service displaying adjustable conditions (see Section 4) and does not require the existence of a workmanship or material related condition in order to qualify for adjustment. THIS POLICY IS NOT A WARRANTY THAT YOUR TIRE WILL NOT FAIL OR BECOME UNSERVICEABLE IF NEGLECTED OR MISTREATED.

1. ELIGIBILITY

- This Policy applies to the owner of Passenger Car, Light Truck and Serva-Spare tires bearing the General brand name and serial numbers, and operated in normal service.
- Eligible tires must be the original equipment tires, used on the vehicle on which they were originally installed by the vehicle manufacturer.
- Tires branded "used" are not eligible under this Policy.

2. WHAT IS THE ADJUSTMENT POLICY AND FOR HOW LONG?

Limited warranty coverage is for a maximum period of 72 months from the date of purchase*, determined by the new vehicle registration date or new vehicle sales invoice showing date of purchase.

If an eligible Passenger or Light Truck or Serva-Spare tire, used in normal service, becomes unserviceable from a condition other than those listed under Section 4, during or after the time or treadwear periods shown below, it will be replaced with a comparable** new General brand tire according to (A) and (B) below.

(A) Free Replacement Policy:

| | <u>Time*</u> | <u>Treadwear</u> |
|--------------------------|---|------------------|
| Passenger Tire | First 12 Months or First 2/32nds, (whichever comes first). | |
| | Mounting & balancing included free of charge. Owner pays all applicable taxes. | |
| Light Truck Tire | First 12 Months or First 3/32nds, (whichever comes first). | |
| | Mounting & balancing included free of charge. Owner pays all applicable taxes. (Excluding F.E.T.) | |
| Serva-Spare Tires | No Time Limit First 1/32nd | |
| | Mounting & balancing included free of charge. Owner pays all applicable taxes. | |

(B) Pro Rata Replacement Policy:

Passenger/Light Truck Tires

After the "Free Replacement Policy" expires (set forth in section 2A), and the tire is still within 72 months from the date of purchase*, you will pay, on a pro rata basis, for a comparable** new General brand replacement tire. A tire is eligible for an adjustment on a pro rata basis until the tread is worn down to the tread wear indicators (2/32nds of an inch of tread remaining). The tire tread is worn out at this point and this Policy ends regardless of time period. Owner pays all applicable taxes (including F.E.T.), mounting and balancing charges.

Serva-Spare Tires

After the "Free Replacement Policy" expires (set forth in section 2A), no adjustment will be made.

* At the time of claim, you need to present your new vehicle registration or new vehicle sales invoice showing date of purchase. If satisfactory proof-of-purchase date is not provided, the D.O.T. certification date of manufacture (tire serial number) will be used.

** A "comparable" new General brand tire may be either the same tire line or the same basic construction but with a different sidewall or tread configuration. If a higher-priced tire is accepted as replacement, the owner will pay the difference in price. Any tire replaced under this Policy will be covered by the current General Tire Limited Warranty and Adjustment Policy

3. HOW A PRO RATA PRICE IS CALCULATED

The replacement tire price will be determined by multiplying the percentage of the usable tread worn by the Dealers Selling Price (excluding all applicable taxes) at the time of the adjustment or the General brand current published Adjustment Base Price, whichever is lower. The usable tread is the original tread down to the tread wear indicators (2/32nds of an inch of tread remaining). The Adjustment Base Price is intended to fairly represent a Dealer's Selling Price for the same or comparable tire.

(Continued on page 24)

4. WHAT IS NOT COVERED BY THE ADJUSTMENT POLICY

a. The following conditions are not covered:

Road Hazard: Cuts, snags, punctures, bruises or impact breaks and any damage caused by puncture or tire repair.

Ride/Vibration: After "Free Replacement Policy" (set forth in section 2A) expires.

Tire Damage or Failure Resulting From Improper Operation or Maintenance: Load, speed, and inflation practices causing excessive operational temperatures to exceed the tire capabilities.

Tire damage (including irregular treadwear) or failure resulting from: improper mounting or demounting, damaged rim, wheel alignment, tire trueing, chain damage, brakes or any similar mechanical problem, extreme temperature exposure, misuse, negligence, and abusive driving such as tire spinning, racing or accident damage.

Tire failure resulting from intentional alterations: such as adding a white inlay on a blackwall or sealant materials.

Age Conditions: Weather checking/cracking coverage is for a maximum period of 48 months from the date of purchase.

b. General Exclusions -

Tire(s) submitted for an adjustment in service for longer than 72 months from date of purchase*, are not covered by this policy.

Tire(s) on any vehicle registered and normally operated outside the United States and Canada are not covered under this Policy. For tires on vehicles normally operated outside the United States and Canada, see the nearest General Tire dealer or distributor for local coverage.

Tire(s) transferred from the vehicle on which they were originally installed are not covered under this Policy.

Company does not offer tread wearout coverage up to a predetermined mileage under this Policy.

Tire(s) used in racing related activities or competitive events are not covered by this Policy.

THIS LIMITED WARRANTY IS IN LIEU OF ALL OTHER WARRANTIES, EXPRESS OR IMPLIED, INCLUDING, BUT NOT LIMITED TO, WARRANTIES OF MERCHANTABILITY OR FITNESS FOR A PARTICULAR PURPOSE. NO OTHER WARRANTIES, EXPRESS OR IMPLIED, INCLUDING, BUT NOT LIMITED TO, WARRANTIES OF MERCHANTABILITY OR FITNESS FOR A PARTICULAR PURPOSE, ARE MADE OR INTENDED BY COMPANY. COMPANY DISCLAIMS ALL IMPLIED WARRANTIES, INCLUDING WARRANTIES OF MERCHANTABILITY OR FITNESS FOR A PARTICULAR PURPOSE. ANY IMPLIED WARRANTIES, INCLUDING, BUT NOT LIMITED TO, ANY WARRANTY OF MERCHANTABILITY OR FITNESS FOR A PARTICULAR PURPOSE, ARE LIMITED IN DURATION TO THE DURATION OF THIS WRITTEN WARRANTY. SOME STATES DO NOT ALLOW LIMITATIONS ON HOW LONG AN IMPLIED WARRANTY LASTS, SO THE ABOVE LIMITATION MAY NOT APPLY TO YOU.

NO COMPANY EMPLOYEE, RETAILER OR DEALER HAS THE AUTHORITY TO MAKE ANY WARRANTY, REPRESENTATION, PROMISE OR AGREEMENT ON BEHALF OF COMPANY EXCEPT AS STATED IN THIS LIMITED WARRANTY.

TO THE EXTENT PERMITTED BY LAW, COMPANY DISCLAIMS LIABILITY FOR ALL CONSEQUENTIAL AND INCIDENTAL DAMAGES. THE REMEDIES SET FORTH IN THIS LIMITED WARRANTY ARE THE SOLE AND

EXCLUSIVE REMEDIES FOR BREACH OF WARRANTY. SOME STATES DO NOT ALLOW THE EXCLUSION OR LIMITATION OF INCIDENTAL OR CONSEQUENTIAL DAMAGES SO THE ABOVE LIMITATIONS OR EXCLUSION MAY NOT APPLY TO YOU. THIS WARRANTY GIVES YOU SPECIFIC LEGAL RIGHTS, AND YOU MAY ALSO HAVE OTHER RIGHTS WHICH MAY VARY FROM STATE TO STATE.

5. COMPANY'S OBLIGATIONS

Any replacement qualifying under this Adjustment Policy will be made by any General brand authorized dealer or vehicle dealer authorized to handle General brand tire adjustments. Company will replace the tire pursuant to the terms of this Adjustment Policy.

6. OWNER'S OBLIGATIONS

To make a claim under this Policy concerning any tire which is covered by this Policy, you must present your claim with the tire to any General brand tire dealer or vehicle dealer authorized to handle General brand tires. For the nearest General brand tire dealer, check the Yellow Pages, or use the General brand Internet address, or one of the "800" numbers shown under "For Customer Assistance." To be eligible for the terms of this Policy, you need to present your new vehicle registration form or new vehicle sales invoice showing date of purchase. Tires replaced on an adjustment basis become the property of Company. You will be required to sign the Company Limited Warranty Claim Form or dealer replacement sales receipt.

You are responsible for payment of all applicable taxes demounting, mounting and balancing charges set forth under this Policy. You are also responsible for payment of local tire-disposal fees and any parts or service regardless of mileage or months of service. This includes payment for tire rotation, alignment, towing, road service, valve stems and tire repairs.

(Continued on page 25)

Owner is responsible for maintaining proper tire air pressure and for proper maintenance of the tire.

THE WARRANTOR

The warrantor of General brand tires is Continental Tire North America, Inc., 1800 Continental Blvd., Charlotte, NC 28273.

For Customer Assistance:

1-800-847-3349 (Nationwide)

1-800-461-1776 (In Canada)

<http://www.generaltire.com>

SAFETY WARNING

Disregarding any of the safety precautions and instructions contained in the Owner's Manual or the Important Tire Safety Information in this booklet may result in tire failure or explosion causing serious personal injury or death.

ELIGIBILITY

You are eligible for the benefits of this policy if you are the owner or authorized agent of the owner of new Goodyear highway auto and light truck tires bearing Department of Transportation prescribed tire identification numbers, and if your tires have been used only on the vehicle on which they were originally installed according to the vehicle manufacturer's recommendations.

COVERAGE (REPLACEMENT FREE)

Any new Goodyear highway radial auto tire or radial light truck tire, except Unisteel radial light truck tires, covered by this policy, that does not deliver satisfactory highway service due to a workmanship or material related condition (see Adjustment Policy Limitations) during the first 25% of usable treadwear, or twelve months from date of purchase, whichever comes first, will be replaced with a comparable new Goodyear tire without charge. Mounting and balancing are included.

Any Goodyear temporary spare tire that does not deliver satisfactory highway service due to a workmanship or material related condition during the first 50% of usable tread depth (1/32 of an inch) will be replaced with a comparable new Goodyear temporary spare tire without charge. Mounting is included. After the first 50% of usable treadwear, you pay only an adjustment charge for the treadwear received, plus any mounting charge.

COVERAGE (PRORATED ADJUSTMENT)

Tires not eligible for no charge adjustment that do not deliver satisfactory service due to a workmanship or material related condition will be replaced with comparable new Goodyear tires on a pro rata basis. The replacement price will be calculated by multiplying the current Goodyear "predetermined price for adjustment" or current advertised price at adjustment location (whichever is lower) by the percentage of usable original tread that has been worn off at the time of the adjustment. You pay for mounting, balancing, and an amount equal to the full current Federal Excise Tax applicable to the comparable new replacement tire.

The "predetermined price for adjustment," available at all Goodyear Auto Service Centers and participating dealers, fairly represents the actual regular retail selling price of the comparable tire at the time of adjustment. If a "predetermined price for adjustment" is not available, adjustment will be based on the price at which you are entitled to buy at the time of adjustment.

A tire has delivered its full original tread life and this warranty ends when the treadwear indicators become visible, regardless of age or mileage.

DEFINITION OF COMPARABLE TIRE

A "comparable" new Goodyear tire may either be the same line of tire or, in the event the disabled tire is out of production, the same basic construction and quality with different sidewall or tread configuration.

If a higher priced tire is accepted as replacement, the difference in price will be additional.

Any tire replacement under this warranty will be covered by the Goodyear warranty in effect at time of replacement.

ADJUSTMENT POLICY LIMITATIONS

This limited warranty is applicable only in the United States and Canada.

No representative or dealer has authority to make any representation, promise, or agreement on behalf of Goodyear, except as stated herein.

The following are not covered by this policy:

- Goodyear does not warrant and will not give credit in any adjustment transaction for any kind of material added to the tire after leaving a Goodyear factory, nor will it adjust any tire which has failed as a result of adding any such material. (Example: Tire fillers, sealants, or balancing substances.)

- Irregular wear or tire damage due to:
 - Road hazards (including punctures, cuts, snags, impact breaks, etc.).
 - Wreck, collision, or fire.
 - Improper inflation, overloading, high speed spinup, mis-application, misuse, negligence, racing, chain damage or improper mounting or demounting.
 - Mechanical condition of the vehicle.
 - Ride disturbance after the first 25% of usable treadwear or due to damaged wheels or any vehicle condition.
 - Temporary spare tires used on vehicle used in racing and on passenger cars in special applications, such as police pursuit service.
 - Any tire intentionally altered after leaving a Goodyear factory to change its appearance. (Example: White inlay on a black tire.)
 - Tires with weather cracking which were purchased more than four (4) years prior to presentation for adjustment. If you have no proof of purchase date, tires manufactured four (4) or more years prior to presentation are not covered.
 - Loss of time, inconvenience, loss of use of the vehicle or consequential damage.

Some states do not allow the exclusion or limitation of incidental or consequential damages so the above limitations or exclusion may not apply to you.

Any tire, no matter how well constructed, may fail in service or otherwise become unserviceable due to conditions beyond the control of the manufacturer. This warranty is not intended as a representation that a tire failure cannot occur.

OWNER'S OBLIGATIONS

- a. You must present the tire to be adjusted to a Goodyear Auto Service Center or Goodyear Tire Dealer. (Please consult your telephone directory for locations.) Tires replaced on an adjustment basis become the property of The Goodyear Tire & Rubber Company.
- b. You must pay for taxes or any additional service you order at the time of adjustment.
- c. No claim will be recognized unless submitted on a Goodyear claim form (supplied by Goodyear dealer or Auto Service Center) completely filled out and signed by you, the owner of the tire presented for adjustment, or your authorized agent.

LEGAL RIGHTS

This warranty gives you specific legal rights, and you may also have other rights which vary from state to state.

THE WARRANTOR

The warrantor of Goodyear tires is The Goodyear Tire & Rubber Company, 1144 E. Market Street, Akron, Ohio 44316.

For Customer Assistance:
1-800-321-2136 (Nationwide)

SAFETY WARNING

Follow safety precautions and instructions contained in the Owner's Manual, tire placard in the vehicle or the Important Tire Safety Information in this booklet. Disregarding tire safety information may result in tire failure or explosion causing serious personal injury or death.

WHO IS COVERED

The owner of a Michelin Passenger or Light Truck tire which bears the Michelin name and complete DOT identification number.

WHAT IS COVERED AND FOR HOW LONG

Michelin Passenger and Light Truck tires, used in normal service on the vehicle on which they were originally fitted and in accordance with the maintenance recommendations and safety warnings contained in the owner's manual and in the Important Tire Safety Information Section of this booklet, are covered by this warranty against defects in workmanship and material for the life of the original usable tread, or 6 years from the date of purchase, whichever comes first. At that time, all warranties, express or implied, are terminated. The usable tread is the original tread down to the level of the tread wear indicators - 2/32nds of an inch (1.6mm) of tread remaining. Date of purchase is documented by new vehicle registration or tire sales invoice. If no proof of purchase, coverage will be based on date of manufacture.

WHAT IS NOT COVERED

Tires which become unserviceable due to:

- Road hazard injury (e.g., a cut, snag, bruise, impact damage, puncture, whether repairable or not);
- Incorrect mounting of the tire, tire/wheel imbalance, or improper repair;
- Underinflation, overinflation, improper maintenance or other abuse;
- Mechanical irregularity in the vehicle such as wheel misalignment resulting in uneven or rapid wear;
- Accident, fire, chemical corrosion, tire alteration, or vandalism;
- Ozone or weather cracking.

WHAT MICHELIN WILL DO**PASSENGER AND LIGHT TRUCK TIRES**

A tire which becomes unserviceable due to a condition covered by this warranty will be replaced with a comparable new Michelin tire, free of charge, when 2/32nds of an inch (1.6mm) or less of the original tread is worn, (or 25% or less, whichever is most beneficial to the user) and within 12 months of the date of purchase. Mounting and balancing of tires is included. The cost of any other service charges or applicable taxes are payable by the user.

When more than 2/32nds of an inch of original tread has been worn (or more than 25%, whichever is most beneficial to the user) or after 12 months from date of purchase, the user must pay the cost of a comparable new Michelin passenger or light truck replacement tire on a pro-rata basis. The dealer shall determine the charge by multiplying the percentage of the original usable tread worn by the current actual selling price at the adjustment location or the price on the current Michelin Base Price List, whichever is lower. This List is based on a predetermined price intended to fairly represent the actual selling price of the tire. The cost of mounting, balancing and any other service charges or applicable taxes are payable by the user.

(Continued on page 29)

WHAT THE CONSUMER MUST DO

When making a claim under the terms of this warranty, the consumer must present the tire to an authorized Michelin Dealer. To locate an Authorized Tire Dealer, check the yellow pages under "Tire Dealers - Retail."

The vehicle on which the tire was used should be available for inspection.

It is essential that you read and understand the safety and maintenance recommendations (see Safety Maintenance Information) for your tires.

CONDITIONS AND EXCLUSIONS

THIS WARRANTY DOES NOT PROVIDE COMPENSATION FOR LOSS OF TIME, LOSS OF USE OF VEHICLE, INCONVENIENCE OR CONSEQUENTIAL DAMAGE.

TIRES PRESENTED FOR CLAIM REMAIN THE PROPERTY OF THE CONSUMER AND MICHELIN ACCEPTS NO RESPONSIBILITY FOR LOSS OF, OR DAMAGE TO, TIRES WHICH ARE IN THE CUSTODY OR CONTROL OF A MICHELIN TIRE DEALER FOR THE PURPOSES OF INSPECTION FOR WARRANTY ADJUSTMENT. IN THE EVENT OF A DISPUTED CLAIM, THE CONSUMER MUST MAKE THE TIRE AVAILABLE FOR FURTHER INSPECTION.

NO MICHELIN REPRESENTATIVE, EMPLOYEE OR DEALER HAS THE AUTHORITY TO MAKE OR IMPLY ANY REPRESENTATION, PROMISE OR AGREEMENT, WHICH IN ANY WAY VARIES THE TERMS OF THIS WARRANTY.

THIS WARRANTY APPLIES ONLY IN THE UNITED STATES AND CANADA.

CONSUMER RIGHTS

THIS WARRANTY GIVES YOU SPECIFIC LEGAL RIGHTS, AND YOU MAY ALSO HAVE OTHER RIGHTS WHICH VARY FROM STATE TO STATE AND PROVINCE TO PROVINCE.

SAFETY MAINTENANCE INFORMATION

Read your vehicle owners manual, the information on the sidewall of your tires, the vehicle tire information placard and the Important Tire Safety Information section of this booklet for essential safety and maintenance information.

THE WARRANTOR

The warrantor of Michelin Tires is Michelin North America, Inc. 1 Parkway South, P.O. Box 19001, Greenville, South Carolina 29602-9001.

For Customer Assistance:

1-800-TIRE HELP (800-847-3435) - U. S.
1-800-461-8473 - Canada (outside Quebec)
1-800-565-7638 - Canada (Quebec)

DANGER

Disregarding any of the safety precautions and instructions contained in the Owner's Manual or the Important Tire Safety Information in this booklet may result in tire failure or explosion causing serious personal injury or death.

PASSENGER TIRES AND LIGHT TRUCK TIRES LIMITED WARRANTY

Toyo Tire (U.S.A.) Corporation warrants Toyo brand passenger tires and light truck tires mounted on vehicles as original equipment for adjustable conditions as follows:

1. What is covered by the warranty:

Toyo brand passenger and light truck tires are warranted for adjustable conditions other than those listed under "What Is Not Covered" for the new original usable tread down to the treadwear indicators (2/32nd" tread remaining) or for 60 months from the date of manufacture, whichever comes first. The DOT serial number on the sidewall of the tire will be used to determine date of manufacture. This time limit does not apply to Toyo temporary spare tires. Presence of a manufacturing anomaly is not necessarily required to qualify for adjustment.

- (A) When *less than 25%* of the original usable tread of a radial tire, or less than 50% of the original usable tread of a temporary spare tire has been worn, the tire will be replaced with a new Toyo tire free of charge, including mounting and balancing. (Adjustments for ride disturbances or vibration, which cannot be corrected by balancing are only adjustable in the first 25% of usable tread.) Service charges or any applicable taxes are payable by you.
- (B) When *more than 25%* of the original usable tread of a radial tire, or more than 50% of the original usable tread of a temporary spare tire has been worn the user must pay for the cost of a replacement tire based on the amount of tread used. This is

calculated by dividing the number of 32nds of an inch used by the original usable tread depth and multiplying by the actual current dealer selling price. Service charges or any applicable taxes are payable by you.

2. What is not covered by the warranty:

- (A) Mileage is not warranted.
- (B) Damage due to road hazards whether repairable or not (such as cuts, snags, bruises, impact or punctures, improper tire chains).
- (C) Irregular tread wear or rapid tread wear due to failure to rotate the tires at recommended intervals, or from vehicle misalignment.
- (D) Damage resulting from improper repair materials or procedures.
- (E) Damage from incorrect mounting or dismounting of the tire, incorrect wheel size, or failure to balance the tires.
- (F) Damage or uneven tread wear from incorrect inflation, overloading, fire, theft, defective mechanical conditions such as brakes, shocks, rims, wreck or collision, and willful damage or abuse.
- (G) Damage, corrosion, or rubber deterioration due to the use of oil-based chemicals, water-based sealers, balancing substances, or flammable gases.
- (H) Ride, balance, or vibration complaints after the first 25% of tread wear.
- (I) Minor surface blemishes due to weathering and normal wear and tear which do not affect the serviceability of the tire.

- (J) Any tire which has been run to destruction while flat.
- (K) Tires used in commercial service.
- (L) Claims after 5 years from the date the tire was manufactured.
- (M) Tires on vehicles normally operated outside the United States.
- (N) Claims made by anyone other than the original retail purchaser of the vehicle.
- (O) Tires with the D.O.T. identification number removed or rendered illegible, or branded "used".
- (P) Any claim where the tire is not presented and available for Toyo's inspection.
- (Q) Any tire for which mileage and tire rotation records are not available or verifiable.
- (R) Any tires worn beyond the wear bars (less than 2/32" remaining tread).
- (S) Temporary spare tires used at speeds over 50 miles per hour.
- (T) Dealer service charges are not covered for routine or required maintenance of the tires such as alignments or rotation.

CONSUMER'S OBLIGATION

The consumer is responsible for proper tire care and maintenance:

- (1) Tires must be rotated every 7,500 miles or sooner if upon inspection, irregular or erratic tread wear is beginning to appear. Keep a record of the rotation.
- (2) The consumer must maintain the recommended

air pressure in the tires according to Nissan's recommendation.

- (3) The consumer must maintain the vehicle's alignment in accordance with Nissan's specifications.
- (4) The load capacity of the tires must not be exceeded.
- (5) The tire's maximum speed capability must not be exceeded.

TO MAKE A CLAIM UNDER THIS LIMITED WARRANTY

In the event that you make a claim under the terms of the warranty, you must:

- (1) Present your tires, and your vehicle to an authorized Toyo Dealer. (Call consumer relations at (800) 442-8696 or check dealer locator at <http://www.toyo.com> for the nearest dealer location.)
- (2) Complete and sign the Toyo Standard Claim form provided by the dealer and leave the tire with the dealer for warranty processing.

NOTE: For your convenience, your nearest authorized Nissan Dealership will also assist you with your tire service requirements or in obtaining tire warranty service from the tire manufacturer.

The consumer is entitled to an adjustment in accordance with the warranty that was in effect when the tire was installed on the vehicle as original equipment. The adjustment policy provides for replacement with a comparable new Toyo tire if a Toyo tire becomes unserviceable due to an adjustable condition verified by Toyo's inspection of the tire. Free replacement or a pro-rated charge depends

on the remaining usable tread when the tire is presented for adjustment.

EXCLUSIONS AND LIMITATIONS

This warranty is limited to the 50 United States, and the District of Columbia. All implied warranties, including warranty of merchantability or fitness for a particular purpose are expressly limited to the duration of this warranty. All obligations or liabilities for incidental or consequential damages are hereby excluded (such as loss of time, loss of use of vehicle, towing charges or road service or inconvenience). Some states do not allow limitations on how long an implied warranty lasts, or the exclusion or limitation of incidental or consequential damages, so the above limitations or exclusions may not apply to you. No Toyo employee, representative or dealer has the authority to make or imply any representation, promise or agreement which in any way varies the terms of this warranty. This warranty gives you specific legal rights and you may also have other rights which vary from state to state.

Important: In accordance with Federal Law, this warranty has been designated as a "Limited Warranty". Nothing in this warranty is intended to be a representation that tire failures cannot occur.

THE WARRANTOR

The warrantor of Toyo Tires is Toyo Tire U.S.A. Corp., 6415 Katella Ave., Suite 200, Cypress, CA 90630.

IMPORTANT SAFETY AND MAINTENANCE INFORMATION!

Any tire, no matter how well constructed, can fail as a result of punctures, impact damage, improper inflation or other conditions resulting from use. Tire failures may create a risk of property damage or personal injury. To reduce the risk of tire failure, we strongly recommend the following:

WARNING!

SERIOUS INJURY MAY RESULT FROM:

1. Tire failure due to underinflation, vehicle overloading, or use in excess of legal speeds – follow owner's manual or tire information placard in your vehicle.
2. Explosion of tire/rim assembly due to improper mounting – only specially trained persons should mount tires.

Refer to Important Tire Safety Information and instructions contained in this booklet, the tire placard in the vehicle or the Owner's Manual.

WHO IS THE WARRANTOR

The warrantor of the tires supplied as original equipment on your new Nissan vehicle is the tire manufacturer or tire distributor of your specific tires. Nissan is **NOT** the warrantor of your original equipment tires. The warrantor for each of the tire brands which may be installed as original equipment on your new Nissan is listed below.

■ **BFGoodrich Tires**

P.O. Box 19026
Greenville, South Carolina 29602-9026
1-877-788-8899

■ **Bridgestone and Firestone Tires**

Bridgestone/Firestone, Inc.
Attn: Technical Services
One Bridgestone Park
Nashville, Tennessee 37214
1-800-TIREBSA (1-800-847-3272)

■ **Continental General Tire, Inc.**

1800 Continental Blvd.
Charlotte, North Carolina 28273
1-800-847-3349
1-800-461-1776 (In Canada)
<http://www.contigentire.com>

■ **Goodyear Tire & Rubber Company (Goodyear and Dunlop Tires)**

1144 E. Market Street
Akron, Ohio 44316
1-800-321-2136

■ **Michelin North America, Inc.**

1 Parkway South
P.O. Box 19001
Greenville, South Carolina 29602-9001
1-800-TIRE HELP
(1-800-847-3435) - U. S.
1-800-461-8473 - Canada (outside Quebec)
1-800-565-7638 - Canada (Quebec)

■ **Toyo (U.S.A.) Corporation**

6415 Katella Ave., Suite 200
Cypress, California 90630
1-800-442-8696
<http://www.toyo.com>

WHAT IS COVERED

The tire manufacturer's warranty for the specific tires supplied as original equipment on your vehicle may be found on the preceeding pages.

Please refer to the following pages for important safety information.

WHAT YOU MUST DO

To obtain information on tire warranties and tire dealer service locations or for customer service, contact the appropriate warrantor listed above.

In order to obtain warranty service, you must present the unserviceable tire to an authorized Nissan dealer or to an authorized dealer of the warrantor in the United States or Canada. Their names and addresses are listed in your local telephone directory. Your Nissan dealer will also assist you with your tire service requirements or in obtaining tire warranty service from the tire manufacturer.

Any tire, no matter how well constructed, may fail due to improper maintenance or service factors. This could create a risk of property damage and serious or fatal injury. Disregarding any of the safety precautions and instructions contained in this manual may result in tire failure or explosion causing serious personal injury or death. For your safety, comply with the following:

TIRE INFLATION

Keep tires inflated to the pressures recommended on the tire data placard. (See your OWNER'S MANUAL for location.) These inflation pressures must be maintained as a minimum. However, do not exceed the maximum pressure rating indicated on the tire sidewall.

CHECK INFLATION PRESSURES ON ALL YOUR TIRES, INCLUDING THE SPARE, WHEN TIRES ARE COLD, AT LEAST ONCE A MONTH BEFORE DRIVING.

Failure to maintain correct inflation may result in improper vehicle handling and may cause rapid and irregular tire wear, sudden tire destruction, loss of vehicle control and serious personal injury. Therefore, inflation pressures should be checked at least once a month and always prior to long distance trips.

Pressures should be checked when tires are cold. The tires are cold when your vehicle has been driven less than a mile at moderate speed after being stopped for three or more hours.

CHECKING PRESSURE WHEN TIRES ARE HOT

If you must add air when your tires are hot, add four pounds per square inch (psi) (28kPa) above the recommended cold air pressure. Recheck the inflation pressure when the tire is cold.

For Example Only:

Gauge reading of hot tire: 32psi
 If recommended pressure is: 30psi
 Desired gauge reading of hot tire $30 + 4\text{psi} = 34\text{psi}$

Check cold pressures as soon as possible, at least by the next day. Never "bleed" air from hot tires as your tire will be underinflated. Use an accurate tire gauge to check pressures. Never allow children to air up tires.

DRIVING ON ANY TIRE THAT DOES NOT HAVE THE CORRECT INFLATION PRESSURE IS DANGEROUS.

For replacement tires, the correct inflation pressure will be provided by your tire dealer, if not, refer to the vehicle decal.

Underinflation produces extreme flexing of the sidewalls and builds up heat which may result in sudden tire destruction and serious personal injury. Overinflation can cause the tire to be more susceptible to impact damage.

LOAD LIMITS

DONOT OVERLOAD. DRIVING ON ANY OVERLOADED TIRE IS DANGEROUS. Never load your tires beyond the load carrying limits molded into the sidewall of the tires or the maximum vehicle load limit as shown on the vehicle tire data placard, whichever is less. Overloading causes heat to build up which can lead to sudden tire failure and

serious personal injury.

SPEED LIMITS AND SPEED RATED TIRES

HIGH SPEED DRIVING CAN BE DANGEROUS.

Never operate your vehicle in excess of lawful speeds or the maximum speeds justified by the driving conditions. Excessive speeds or racing can cause heat buildup in a tire leading to possible failure and serious personal injury.

Correct inflation pressure is especially important.

However, at high speeds, even with the correct inflation pressure, a road hazard, for example, is more difficult to avoid and if contact is made, there is a greater chance of causing tire damage than at the lower speed. Moreover, driving at high speed reduces the reaction time available to avoid accidents and bring your vehicle to a safe stop. If you see any damage to a tire or wheel, replace it with your spare tire and see your tire dealer at once.

Tire speed ratings do not imply that a vehicle can be safely driven at the maximum speed for which the tire is rated. In addition, some damages or improper repairs may cause a speed-rated tire to lose its speed rating. Exceeding the tire's maximum speed rating will cause the tire to build up excessive heat which can cause tire damage that could result in sudden tire destruction and rapid air loss. Failure to control a vehicle with sudden air loss can lead to an accident. In any case, you should not exceed reasonable speeds as indicated by the legal limits and driving conditions.

(Continued on page 34)

* Provided by and published at the request of the tire manufacturers/warrantors.

SPEED SYMBOLS - are shown on the sidewall of some tires. The following table shows the maximum speed corresponding to the symbol.

SPEED RATINGS

| †Speed Rating | Speed mph | Maximum km/Hr |
|---------------|-----------|---------------|
| M | 81 | 130 |
| N | 87 | 140 |
| P | 93 | 150 |
| Q | 99 | 160 |
| R | 106 | 170 |
| S | 112 | 180 |
| T | 118 | 190 |
| H | 130 | 210 |
| V* | 149 | 240 |
| Z** | 149 | 240 |

***Some V (or VR) rated tires may have a speed capacity of greater than 149 mph (240 km/h).** Consult your tire manufacturer for maximum speed ratings if your vehicle capability exceeds this speed.

****Z (or ZR) rated tires are designed for use on cars with maximum speed capabilities in excess of 149 mph (240 km/h).** Consult your tire manufacturer for maximum speed capabilities.

†Although a tire may be speed rated, we do not endorse the operation of a vehicle in an unsafe or unlawful manner.

Speed ratings are based on laboratory tests which relate to performance on the road, but are not applicable if tires are underinflated, overloaded, worn out, damaged, altered, improperly repaired, or retreaded. Furthermore, tire speed ratings do not imply that vehicles can be safely driven at the maximum speed for which the tire is rated, particularly under adverse road and weather conditions or if the vehicle has unusual characteristics. Most highway passenger tires that do not have a speed symbol in the sidewall have a maximum speed rating of 105 mph. Light truck highway tires that do not have a speed symbol on the sidewall of the tire have a maximum speed of 87 mph. Some light truck tires may have higher maximum speeds; consult your tire dealer. The speed and other ratings of retreaded tires are assigned by the retreader and voids the original manufacturer's ratings.

IMPORTANT: *In order to maintain the speed capability of the vehicle, replacement tires must have speed ratings equal to or higher than those fitted as original equipment (as indicated on the vehicle placard or owners manual). If tires with lower speed ratings are fitted, the speed capability of the vehicle will be lowered to the maximum speed capability of the replacement tire as indicated on the above table.*

Remember...High speed driving can be dangerous and may be damaging to your tires. And...When driving at highway speeds, correct inflation pressure is especially important.

Contact the manufacturer of your tires for their position and assistance on the repair of speed-rated tires. When you are replacing tires that have a speed rating, you must replace with tires of the same or higher speed rating if the speed capability of the vehicle is to be maintained.

VISUAL INSPECTION

INSPECT YOUR TIRES. DO NOT DRIVE ON A DAMAGED TIRE OR WHEEL. Check your tires frequently for scrapes, bulges, separations, cuts, snags, cracks, penetrations or excessive localized wear from hard braking. Also check for abnormal tire wear, particularly on the edges of the tire tread which may be caused by misalignment or underinflation. Impacts can damage the inner portion of the tire without being visible on the outside. If damage can be seen on the tires or wheels, or if you suspect that possible impact damage may have occurred, replace with spare at once and have your tire store or dealer inspect your tires immediately. Use of a damaged tire could result in tire destruction. When inspecting your tires, including the spare, check your air pressures. If your pressure check indicates that one of your tires has lost pressure of two pounds or more, look for signs of penetrations, valve leakage, or wheel damage that may account for the air loss.

All tires will wear out faster when subjected to high speeds as well as hard cornering, rapid starts, sudden stops, frequent driving on roads which are in poor condition, and off-road use. Roads with holes and rocks or other objects can damage tires and cause misalignment of your vehicle. When you drive on such roads, drive on them carefully and slowly, and before driving again at normal or highway speeds, examine your tires for any damage, such as cuts, bulges, penetrations, unusual wear patterns, etc.

(Continued on page 35)

* Provided by and published at the request of the tire manufacturers/warrantors.

TREAD WEAR INDICATORS (WEAR BARS): Tires contain Tread Wear Indicators (Wear Bars) in the grooves of the tire tread which **show up when only 2/32nds of an inch (1.6mm) of tread is remaining. At this stage, your tires must be replaced. Tires worn beyond this stage are dangerous.**

HAZARDS

Objects in the road that threaten a tire should be safely avoided. These objects are potholes, glass, metal, rocks, wood debris and the like. Unavoidable contact should prompt a thorough tire inspection.

You may not always recall hitting an object that can damage or injure your tires. If while driving your vehicle experiences any unusual vibrations, ride disturbance or noise and/or you suspect that possible damage to the tires or vehicle has occurred. **DO NOT JAM OR LOCK YOUR BRAKES!** Rather reduce your speed and drive with caution until you can safely pull off the road. Stop and inspect the tires. If the tire is underinflated or damaged, deflate, remove the tire and rim assembly and replace it with your spare. If you cannot detect a cause, have the vehicle towed to the nearest vehicle or tire dealer to have the vehicle inspected.

REPAIRING, MOUNTING AND DEMOUNTING OF TIRES

Do not attempt to repair, mount or demount a tire yourself. Tire changing can be dangerous and must be done by professionally trained persons using proper tools and procedures as specified by the Rubber Manufacturers Association (RMA). **Follow these mounting recommendations.** Your tires should be mounted on wheels of correct size and type and which are in good, clean condition. Bent, chipped or rusted wheels may cause tire damage. The inside of the tire must be free

from foreign materials. **Have your dealer check the wheels before mounting new tires.** Mismatched tires and rims can explode during mounting. Also, mismatched tires and rims can result in dangerous tire failure on the road. If a tire is mounted by error on the wrong-sized rim, do not remount it on the proper rim - scrap it. It may be damaged internally (which is not externally visible) by being dangerously stretched and could fail on the highway.

Old valves may leak. When new tubeless tires are mounted, have new valves of the correct type installed. Tubeless tires must be mounted only on wheels designed for tubeless tires, i.e., wheels which have safety humps or ledges.

Never perform a temporary repair, use an innertube or inject sealant as a permanent substitute for a proper repair. Only qualified persons should repair tires.

Be sure that all your valves have suitable valve caps. This will keep valve cores clean and clear and guard against leakage.

REPAIRS - WHENEVER POSSIBLE, SEE A TIRE DEALER AT ONCE. *Some tire manufacturers do not warrant any inspection or repair process. The repair is entirely the responsibility of the repairer.* Punctures in the tread of a passenger tire which do not exceed 1/4 of an inch (6mm) in diameter can usually be repaired by following the Rubber Manufacturer's Association (RMA) Passenger and Light Truck Repair procedures. *Contact the manufacturer of your tires for its position and assistance as to the acceptable location for a proper repair and the repair of speed rated tires.* **Do not use plug repairs. They may cause further damage to the tire. They are not always air tight and the plug may fail.** *Do not exceed posted speed limits on any repaired tire. Certain tire manufacturers speed ratings*

are voided if the tire is repaired.

Although a tire was properly repaired, internal structural damage resulting from the puncture may have occurred. Sometime later the damage may cause the tire to be removed from service.

If the tire has a puncture in the tread which exceeds 1/4 inch (6mm), the tire must be replaced. If any tire has sustained a puncture, have the tire inspected internally by a tire dealer for possible damage that may have occurred.

Improper mounting and inflation procedures can cause an explosion of the tire/rim assembly. Only specially trained persons should perform these tasks. Contact your tire store or dealer for assistance.

CAUTION - Never, under any circumstance, introduce a flammable substance into a tire.

WHEEL ALIGNMENT AND BALANCING

Wheel alignment and balancing are important for safety and maximum mileage from your tires. Check how your tires are wearing at least once a month. If your tires are wearing unevenly, such as the inside shoulder of the tire wearing faster than the rest of the tread, or if you detect excessive vibration, your vehicle may be out of alignment or balance. These conditions not only shorten the life of your tires, but adversely affect the handling characteristics of your vehicle which could be dangerous. If you detect irregular wear or vibration, have your alignment and balance checked immediately. Tires which have been run underinflated will show more wear on the shoulders than in the center of the tread.

* Provided by and published at the request of the tire manufacturers/warrantors.

HARD BRAKING

You must inspect your tires after any hard braking circumstances or after tires have slid on the pavement. This can cause a flat spot in a section of the tire tread.

TIRE SPINNING

Never spin your tires above a speedometer reading of 35 mph (55 km/h) if your vehicle becomes stuck. The centrifugal force generated by the free spinning tire/wheel assembly may cause a sudden tire explosion, resulting in vehicle damage and/or serious personal injury or death. Never allow anyone to stand near or behind a tire spinning at high speed while attempting to push a vehicle that is stuck. When in mud, sand, snow, ice or other slippery conditions, do not indulge in excessive wheel spin. In such conditions, with automatic transmission vehicles, by accelerating the engine excessively, it is possible to spin one of the drive tires beyond its speed capability. This is also true when balancing a drive tire/wheel assembly using the engine of the vehicle to spin the wheel.

TIRE TREAD

Tires must be replaced when the depth of the tread reaches 2/32 inch (1.6 mm). Tires are manufactured with tread wear indicators molded into the tire grooves which indicate tread wearout. As tires approximate 2/32 inch (1.6 mm) wearout, the tread gauge becomes thinner and more vulnerable to the effects of road hazards. Also, worn tires are more subject to hydroplaning, which can cause loss of control. Therefore, visual tire inspection becomes more crucial as the tires wear out.

WORN TIRES

Never drive on worn tires. Tires should be replaced by trained personnel when 2/32nds of an inch tread depth remains, as indicated by the tread wear indicators molded into the tread grooves. In most states, it is illegal to drive with less than 2/32nds of an inch of tread remaining.

TIRE MIXING

For best performance *select tires similar in size and load rating to the original equipment tires*. It is recommended that the same size and type of tire be used on all four wheel positions. In certain tires, casing ply material and ply construction may vary as indicated on the sidewall of the tire. When changing or replacing tires, it is preferred that all four tires are the same construction type (i.e., High Performance, All Season, Mud & Snow) and construction (Radial or Bias Ply). Before mixing tires of different types on a vehicle in any configuration, be sure to check the vehicle owner's manual for its recommendations.

Tires which meet the Rubber Manufacturer's Association (RMA) definition of mud and snow tires are marked M/S, M+S, M&S. On such tires, this designation is molded into the sidewall. Tires without this notation are not recommended for mud and/or snow driving.

If snow tires are needed, it is necessary to select tires equivalent in size and load rating to the original equipment tires. Always fit performance snow tires in sets of four (4) for optimum mud & snow traction and maintenance of vehicle handling characteristics. If you do not, it may adversely affect the safety and handling of your vehicle. It is also important to check the vehicle owner's manual before mixing or matching tires on 4-wheel drive vehicles as this may require special precautions.

Please refer to your Owner's Manual for more information on tire replacement precautions.

TIRE ROTATION

Tires on your Nissan vehicle should be rotated every 7,500 miles or as irregular wear develops. If irregular wear becomes apparent or if the wear rate on the tires is perceptibly uneven, the tires should be rotated in such a way to alleviate the problem. Check your vehicle for any mechanical problems and correct if necessary. Any rotation pattern or procedure may be followed including those indicated in the Owner's Manual. Some tires have arrows on the sidewall showing the direction in which the tire should turn. When rotating this type of tire, care must be taken to maintain the proper turning direction as indicated by the arrows. *Some vehicles have different tire sizes specified for front and rear axles. Tires on these vehicles should not be rotated side to side (unless they are directional)*. Where a temporary type spare tire is available, it should not be included in the tire rotation schedule. Such tires are intended for temporary use only. Whenever only two tires are replaced, the new tires should be put on the rear axle *of vehicles equipped with the same size tire on all four wheel positions*.

(Continued on page 37)

* Provided by and published at the request of the tire manufacturers/warrantors.

TRAILER TOWING

If you anticipate towing a trailer, you should see a tire dealer for advice concerning the correct size of tire and pressure. Tire size and pressure will depend on the type and size of the trailer and hitch utilized, but in no case must the maximum cold inflation pressure or the tire load rating be exceeded. Check the tire decal and your Owner's Manual for further recommendations on trailer towing.

TIRE ALTERATIONS

Do not perform any alterations on your tires. Alterations may prevent proper performance, leading to tire damage, which can result in an accident. Tires which become unserviceable due to alterations such as truing, whitewall inlays, addition of balancing or sealant liquids, may be excluded from warranty coverage. Consult your tire warranty.

HIGH PRESSURE TEMPORARY SPARE TIRES

- 1) The high-pressure spare tire in your Nissan vehicle is designed for temporary use only and must not be used continually as a regular tire. The standard tire should be repaired and/or replaced as soon as possible.
- 2) Avoid driving over obstacles that may damage the tire through impact or cutting, such as potholes, glass, metal, etc.

- 3) Speed must not exceed 50MPH (80km/h) for non-speed-rated temporary spare tires.
- 4) Temporary spare tires have a limited treadlife which can vary depending on road conditions and your driving habits. The spare tire should be returned to the trunk as soon as the standard tire can be repaired or replaced.
- 5) Because the high-pressure spare tire was specifically designed for your car, it should not be used on any other vehicle.
- 6) Do not use snow chains on your high-pressure spare. This could cause damage to your vehicle.
- 7) Check the tire's cold inflation pressure monthly and maintain at 60psi (4.2kg/cm²) even when not in use.
- 8) The high-pressure spare tire should not be used with any other rim nor should standard tires, wheel covers, or trim rings be used on the high-pressure spare tire rim which was originally installed.
- 9) When the tread wear indicator appears on the tire, replace it only with the same type spare tire.
- 10) Do not enter an automatic carwash with a temporary spare tire fitted.
- 11) Do not make a sharp turn or apply the brakes suddenly when driving on a high-pressure temporary spare.

Note: *When using any temporary type spare tire, be sure to follow the vehicle Owner's Manual instructions.*

TIRE STORAGE

All tires should be stored in a cool dry place indoors so that there is no danger of water collecting inside them.

When tires are stored they should be stored in a cool place away from sources of heat and ozone such as hot pipes and electric generators. Be sure that surfaces on which tires are stored are clean and free from grease, gasoline or other substances which could deteriorate the rubber. (Tires exposed to these materials during storage or driving could be subject to sudden failure.)

To Avoid Damage to your Tires and Possible Accident:

- Check tire pressure at least once a month when tires are cold and before long trips.
- Do not underinflate/overinflate.
- Do not overload.
- Drive at moderate speeds, observe legal limits.
- Avoid driving over potholes, obstacles, curbs or edges of pavement.
- Avoid excessive wheel spinning.
- If you see any damage to a tire, replace with spare and see the tire manufacturer's dealer or your Nissan dealership.

For further information, the *Consumer Tire Guide* on passenger tire care, safety and mileage performance is available in the United States by writing the Tire Industry Safety Council, Box 1801, Washington, D.C. 20013.

* Provided by and published at the request of the tire manufacturers/warrantors.

WHAT IS COVERED

Nissan* warrants to correct defects in materials or workmanship in all genuine Nissan replacement parts, Genuine NISMO S-tune parts, and Genuine Nissan accessories, distributed by Nissan North America in the United States, installed and used on Nissan (if an appropriate use and application of the part, accessory, or Genuine NISMO S-tune part) vehicles only, except as described under the caption below, "WHAT IS NOT COVERED."

This warranty covers any repairs needed to correct defects in materials or workmanship. Bedliners will be repaired to commercially acceptable standards subject to the conditions and limitations listed in "WHAT IS NOT COVERED."

*Nissan indicates Nissan North America, Inc., P.O. Box 685003, Franklin, TN 37068-5003 which distributes and provides consumer services for Nissan Vehicles in the United States.

HOW LONG IS THE WARRANTY

Except for replacement audio components, this warranty is for 12 months or 12,000 miles from the date of installation or purchase, whichever is earlier. However, the warranty on Genuine Nissan replacement parts, Genuine NISMO S-tune parts, and Genuine Nissan accessories installed in a Nissan vehicle while the vehicle is covered by a Nissan warranty, which would have covered the part had it been installed in the vehicle at manufacture, will not end before the end of that warranty.

REPLACEMENT AUDIO COMPONENTS

A replacement Radio, Tape Deck, Amplifier or Compact Disc Player/Auto Changer supplied by Nissan is covered for 12 months from the time of installation or the balance of the Basic Vehicle Warranty as it applies to audio components, whichever is greater.

WHAT IS NOT COVERED

This warranty does not cover:

1. Tires or batteries. These items are covered by separate warranties.
2. Nissan Motorsports and NISMO R-tune parts, including NISMO Legacy parts are sold "AS IS" without warranties, express or implied unless expressly prohibited from doing so by applicable law, in which case the warranty provided is the minimum required by law.
3. Normal maintenance service and parts replacement as outlined in the maintenance schedule of your OWNER'S MANUAL.
4. Damage or failures of parts resulting from:
 - Misuse (your OWNER'S MANUAL is your guide to proper use).
 - Accident, theft, fire, driving through water resulting in engine water ingestion.
 - Chemical fallout, tree sap, salt, sand, hail, flood or other environmental conditions.
 - Modification or improper repair of the part or of the vehicle in which the part is installed.
 - Use of parts not equivalent in quality or design to parts supplied by Nissan.
 - Lack of performance of required maintenance services as outlined in your OWNER'S MANUAL.
 - Use of improper or dirty fuel, fluids or lubricants.
 - Normal wear and tear, including dings, dents, chips or scratches.
5. SALVAGE TITLE. This warranty does not cover damage, failures or corrosion to any Nissan replacement part, Genuine NISMO S-Tune Part, or Genuine Nissan Accessory, installed in the vehicle, if the vehicle is issued a "salvage" or similar title. (This exclusion does not extend

to new Genuine Nissan replacement parts, NISMO S-tune parts or Genuine Nissan accessories, installed in a Nissan vehicle after the issuance of a "salvage" or similar title.)

WHAT YOU MUST DO

In order to obtain warranty service you must deliver the warranted part or accessory, or the vehicles, on which the part or accessory is installed, to an authorized Nissan dealer in the United States or Canada at your expense with proof of purchase (parts invoice or service repair order from an authorized Nissan dealer).

(Continued on page 39)

LIMITATION OF WARRANTIES AND OTHER WARRANTY TERMS AND STATE LAW RIGHTS

EXTRA EXPENSES - LIMITATIONS OF DAMAGES

This warranty does not cover incidental or consequential damages such as loss of the use of the vehicle, inconvenience or commercial loss.

ANY IMPLIED WARRANTY OF MERCHANTABILITY AND FITNESS FOR A PARTICULAR PURPOSE SHALL BE LIMITED TO THE DURATION OF THIS WRITTEN WARRANTY.

Some states do not allow the exclusion or limitation of incidental or consequential damages or limitations on how long an implied warranty lasts, so the above limitations or exclusions may not apply to you. This warranty gives you specific legal rights, and you may also have other rights, which vary from state to state.

Nissan does not authorize any person to create for it any other warranty, obligation or liability in connection with this vehicle.

The names and addresses of authorized Nissan dealers are listed in telephone directories.

You must also pay for labor charges to remove and replace the part or accessory if it was not originally installed on your vehicle by an authorized Nissan dealer.

WHAT NISSAN WILL DO

If the part or accessory to be repaired was originally installed by an authorized Nissan dealer, it will be removed and reinstalled after repair at no charge for parts and labor. If the part or accessory was not installed by an authorized Nissan dealer, the part or accessory will be repaired or exchanged only. Any needed parts replacement or exchange will be made using new or remanufactured parts at Nissan's option.

WHAT IS COVERED

Nissan² warrants to the first retail purchaser ("Original Repairing Vehicle Owner"), that Nissan will either repair or replace the Genuine Nissan Outer Sheet Metal Panels you install or have installed on your Nissan vehicle should the purchased panels develop inside out rust-through corrosion perforation. Replacement sheet metal panels must be installed on vehicles owned and operated in the United States and Canada. Nissan warrants to the Original Repairing Vehicle Owner that the replacement and refinishing of panels will be carried out at no cost to the Original Repairing Vehicle Owner subject to the exclusions listed.

WHAT IS NOT COVERED

This warranty becomes void when damage results from:

1. Accidents, collision, faulty installation, or any alteration to the panel, panels, or vehicle that could be reasonably expected to affect the performance of the covered panels.
2. Environmental pollution or conditions, including acid rain, hail, or lightning.
3. Vehicle neglect, abuse, or use of the vehicle for unintended purposes.
4. Stone chips, scratches, or other paint damage that lead to surface rust damage.
5. Cleaning and polishing agents, chemicals, and solvents, including improper undercoating or use of other rust prevention materials.

WHAT YOU MUST DO

The purchaser must present the Nissan Lifetime Replacement Panel Corrosion Warranty Form, original

receipts and/or repair orders, and personal identification to a Nissan dealership in order to invoke this warranty. The dealership will then authorize the replacement of the panels at a Nissan dealership's collision repair shop or an independent collision repair shop.

WHAT NISSAN WILL DO

Nissan will pay for the cost of the repair, including parts, labor, paint, and supplies necessary to repair or replace and refinish the panels purchased.

The repair may be completed at an authorized Nissan dealership's collision repair shop or an independent collision repair shop that will install Genuine Nissan replacement parts. Whether a Nissan dealership collision repair shop or independent collision repair shop completes the repair, only authorized Nissan dealership personnel or authorized Nissan personnel can approve a repair or replacement under this warranty.

LIMITATION OF WARRANTIES AND OTHER WARRANTY TERMS AND STATE LAW RIGHTS**EXTRA EXPENSES - LIMITATIONS OF DAMAGES**

This warranty does not cover incidental or consequential damages such as loss of the use of the vehicle, inconvenience or commercial loss.

ANY IMPLIED WARRANTY OF MERCHANTABILITY AND FITNESS FOR A PARTICULAR PURPOSE SHALL BE LIMITED TO THE DURATION OF THIS WRITTEN WARRANTY.

Some states do not allow the exclusion or limitation of incidental or consequential damages or limitations on how long an implied warranty lasts, so the above limitations or exclusions may not apply to you. This warranty gives you specific legal rights, and you may also have other rights which vary from state to state.

Nissan does not authorize any person to create for it any other warranty, obligation or liability in connection with this vehicle.

¹ The actual warranty is provided with the product purchased and should be read carefully.

² Nissan indicates Nissan North America, Inc., P.O. Box 685003, Franklin, TN 37068-5003, which distributes Nissan vehicles in the United States.

WHAT IS COVERED AND FOR HOW LONG

Nissan* warrants to correct defects in materials or workmanship, or for failure due to normal wear and tear, of all replacement **Genuine Nissan Original Equipment muffler assemblies, Genuine Nissan vehicle suspension system shock absorbers and strut assemblies** installed on Nissan vehicles only, except as described under the caption below, "WHAT IS NOT COVERED". **THE LIFETIME FEATURE OF THIS WARRANTY APPLIES ONLY IF** the parts are purchased and paid for by the owner of the vehicle on which they are installed, and only if they are installed by an authorized Nissan dealer, for as long as the original purchaser of the replacement **muffler assembly, shock absorber and/or strut assembly** owns the Nissan vehicle on which the parts are installed.

IMPORTANT: The lifetime feature of this warranty does not apply to parts (a) paid for in whole or in part by Nissan, to include warranty replacement, campaigns or goodwill adjustments, or (b) which are paid for under the terms of any service contract. Such parts are instead warranted against defects in material or workmanship only (but not failure due to normal wear and tear) for 12 months or 12,000 miles from the date of installation or purchase, whichever is earlier. In no case shall the warranty from defects in material or workmanship end prior to the end of the applicable Nissan New Vehicle Limited Warranty on the Nissan vehicle on which the parts are installed, had the part(s) been installed in the vehicle at manufacture.

*Nissan indicates Nissan North America, Inc., P.O. Box 685003, Franklin, TN 37068-5003 which provides consumer service for Nissan vehicles in the United States.

LIMITATION OF WARRANTIES AND OTHER WARRANTY TERMS AND STATE LAW RIGHTS**Extra Expenses - Limitations of Damages**

This warranty does not cover incidental or consequential damages such as loss of the use of a vehicle, substitute transportation, inconvenience or commercial loss.

ANY IMPLIED WARRANTY OF MERCHANTABILITY AND FITNESS FOR A PARTICULAR PURPOSE SHALL BE LIMITED TO THE DURATION OF THIS WRITTEN WARRANTY.

Some states do not allow the exclusion or limitation of incidental or consequential damages or limitations on how long an implied warranty lasts, so the above limitations may not apply to you. This warranty gives you specific legal rights, and you may also have other rights which vary from state to state.

Nissan does not authorize any person to create for it any other warranty, obligation or liability in connection with the part(s) subject to this express limited warranty.

WHAT IS NOT COVERED

This warranty does not cover:

1. Genuine Nissan Key Value® Muffler Assemblies.
2. Shock absorbers and strut assemblies installed before July 1, 1999. Muffler assemblies installed before October 1, 1999.
3. Motorsports Parts and Genuine NISMO R-Tune parts are sold "AS IS" without warranties, express or implied unless expressly prohibited from doing so by applicable law, in which case the warranty is the minimum provided by law.

4. Damage or failure(s) of parts resulting from:
 - Misuse (your OWNER'S MANUAL is your guide to proper use.)
 - Accident, theft, fire, driving through water.
 - Salt, sand, flood or other environmental conditions.
 - Modification or improper repair of the part or of the vehicle in which the part is installed.
 - Use of parts not equivalent in quality or design to parts supplied by Nissan.
5. Salvage Title. This warranty does not apply and is rendered VOID if the vehicle is issued a "salvage," "flood," or similar title under any state's law after the part(s) is purchased unless state law expressly states otherwise. (This exclusion does not extend to new Genuine Nissan Original Equipment muffler assemblies, Genuine Nissan shock absorbers or strut assemblies purchased and installed in the vehicle after the issuance of a "salvage," "flood," or similar title.)

(Continued on page 42)

WHAT YOU MUST DO

In order to obtain lifetime limited warranty service, bring your vehicle, proof-of-purchase (service repair order from an authorized Nissan dealer in the United States) and personal identification (driver's license, etc.) to any authorized Nissan dealer in the United States. The names and addresses of authorized Nissan dealers are listed in telephone directories.

WHAT NISSAN WILL DO

If the lifetime feature of this warranty applies to a Genuine Nissan Original Equipment **muffler assembly, shock absorber** or **strut assembly** it will be removed and reinstalled after repair at an authorized Nissan dealer at no charge for parts or labor.

Otherwise a warranted Genuine Nissan Original Equipment **muffler assembly, shock absorber** or **strut assembly** will be exchanged only unless you can provide proof that it was originally installed by a Nissan dealer, in which case it will be removed and reinstalled after repair at no charge to you for parts or labor during the term of the warranty. Any needed parts replacement or exchange will be made using new or remanufactured parts at Nissan's option.

WHAT IS COVERED?

Nissan* warrants your Genuine Nissan Replacement Battery as described below except as stated under "What is not covered?"

This warranty covers defects in materials and workmanship.

HOW LONG IS THE WARRANTY AND WHAT WILL NISSAN DO

Nissan will replace your battery without charge if it becomes unserviceable within the first 24 months of service.

If the battery becomes unserviceable after 24 months of use, Nissan will provide a replacement battery at a reduced price, charging only for the portion of the life of the battery actually used. This is called a "pro-rata adjustment". Nissan will pay for all labor charges in replacing the battery if it was originally installed by an authorized Nissan dealer.

This warranty and the "pro-rata adjustment" end 84 months after the date of the battery's purchase or installation, whichever is earlier.

WHAT IS NOT COVERED?

This warranty does not cover:

- Damage or failure resulting from:
 - Accident, theft, fire or freezing.
 - Misuse of the battery or vehicle in which it is installed, including the use in applications for which the battery was not designed. Proper use is described in the vehicles Owner's Manual.
 - Improper installation or battery charging.
 - Vehicle electrical malfunctions not covered by your New Vehicle Limited Warranty.

- Modification or improper repair of the vehicle or a part of the vehicle.
 - Use of parts not equivalent in quality or design to parts supplied by Nissan.
 - Environmental conditions, including, but not limited to flood, and salt spray or salt water.
- Normal maintenance service and recharging of discharged batteries.
 - Batteries in service more than 84 months.
 - Salvage Title. This warranty does not cover damage, failure, or corrosion to any Genuine Nissan battery installed in the vehicle, if the vehicle is issued a "salvage" or similar title under any state's law, and this warranty is rendered void for any battery installed in a vehicle prior to the vehicle being issued a "salvage" or similar title unless state law expressly states otherwise. (This exclusion does not extend to a new Genuine Nissan battery installed in the vehicle after the issuance of a "salvage" or similar title).

WHAT YOU MUST DO

In order to obtain warranty service, you must deliver the warranted battery or the vehicle in which the battery is installed to an authorized Nissan dealer in the U.S. or Canada at your expense, with proof of purchase (parts invoice or service repair order from an authorized Infiniti dealer). The names and addresses of authorized Nissan dealers are listed in telephone directories or www.NissanUSA.com

If the "pro-rata adjustment" applies, you must pay for the portion of the 84 month warrantable life that you actually used. The amount you pay is computed in two steps. First, the customer pay percentage is determined from the chart shown below based upon the months of actual battery service.

| Months In Service | Customer Pay Percentage |
|----------------------|----------------------------|
| 0-24 | 0% |
| 25-32 | 25% |
| 33-50 | 50% |
| 51-84 | 75% |

Second, the current suggested retail price of the new battery is multiplied by the customer pay percentage. For example, should the battery fail after 40 months of service you would pay 50% of the suggested retail price of the new battery.

You must also pay for the labor charge to remove and replace the battery if it was not originally installed in your vehicle by an authorized Nissan Dealer.

LIMITATION OF WARRANTIES AND OTHER WARRANTY TERMS AND STATE LAW RIGHTS**EXTRA EXPENSES-LIMITATIONS OF DAMAGES**

This warranty does not cover incidental or consequential damages such as, but not limited to, loss of wages or loss of use of the vehicle, inconvenience, or commercial loss.

ANY IMPLIED WARRANTY OF MERCHANTABILITY AND FITNESS FOR A PARTICULAR PURPOSE IS LIMITED TO THE DURATION OF THE LIMITED WARRANTY.

Some states do not allow the exclusion or limitation of incidental or consequential damages or limitations, so the above limitations or exclusions may not apply to you. This warranty gives you specific legal rights, and you may also have other rights, which vary from state to state.

Nissan does not authorize any person to create for it any other warranty, obligation or liability in connection with this vehicle.

* NISSAN indicates Nissan North America, Inc. PO Box 685003, Franklin, TN 37068-5003, which distributes Nissan vehicles and provides related consumer services in the United States of America

Nissan North America, Inc. and your Nissan dealer realize that there are numerous sources for parts and accessories in today's automotive parts aftermarket. However, Genuine Nissan parts and accessories are designed and manufactured to meet the same factory fit, performance and quality specifications of your Nissan vehicle.

The Parts Department of your Nissan dealership maintains a complete inventory of high quality Genuine Nissan new and remanufactured replacement parts - parts that are backed by one of the most comprehensive parts warranties available in the automotive industry today.

To ensure that your warranty, maintenance and repair parts requirements are satisfied as quickly as possible, Nissan and the Nissan dealer organization maintain a combined inventory consisting of several hundred million dollars worth of readily available parts and popular accessories. In the event a critical part is required that is not stocked by your local dealership, Nissan's ordering system includes a computerized means of ensuring the quickest possible shipment to Nissan dealers by the use of expeditious handling and premium transportation - all of which is supported by one of the most extensive and efficient parts distribution systems in the United States.

Two Nissan North America, Inc. Regional Parts Distribution Centers stock approximately 32,000 different parts and each of five additional Area Parts Distribution

Centers service over 61,000 part numbers. Nissan's Master Parts Distribution Center in Compton, California maintains an inventory of 150,000 low volume part numbers and services all Nissan dealers nationally. All Nissan parts distribution facilities are linked via a sophisticated computer search and order system to ensure coordinated parts ordering, inventory and distribution of available parts.

The Nissan name represents quality and a commitment to your satisfaction as a valued customer. So when you select parts or accessories for your Nissan vehicle, see your Nissan dealer. Only Nissan builds Nissan replacement parts and accessories to exact factory specifications.

RECOMMENDATION FOR MAINTENANCE SERVICE AND REPLACEMENT PARTS FOR YOUR VEHICLE'S EMISSION SYSTEM

To assure best results and to maintain the original quality built into the emission control systems, it is recommended that genuine Nissan parts be used when servicing or repairing the systems. THE WARRANTY OBLIGATIONS ARE NOT DEPENDENT UPON THE USE OF ANY PARTICULAR BRAND OF REPLACEMENT PARTS AND THE OWNER MAY ELECT TO USE NON-GENUINE NISSAN PARTS FOR REPLACEMENT PURPOSES.

The use of replacement parts which are not equivalent to genuine Nissan parts may reduce the effectiveness of the emission control system.

Therefore, if it becomes necessary to use other than genuine Nissan parts, the owner should assure himself that such parts are warranted by their manufacturer to be equivalent in quality to genuine Nissan parts.

MAINTENANCE, REPLACEMENT OR REPAIR OF THE EMISSION CONTROL DEVICES AND SYSTEMS MAY BE PERFORMED BY ANY AUTOMOTIVE REPAIR ESTABLISHMENT OR INDIVIDUAL USING ANY REPLACEMENT PART.

HOWEVER, UNLESS OTHERWISE AUTHORIZED BY LAW, WARRANTY SERVICE MUST BE PERFORMED BY AN AUTHORIZED NISSAN DEALER.

The emission standards may be satisfied by having the vehicle inspected periodically and by following the requirements outlined in your OWNER'S MANUAL and your NISSAN SERVICE MAINTENANCE GUIDE.

In order to help protect your vehicle against corrosion, it is important that you care for your vehicle regularly, following these suggestions:

- Wash your vehicle regularly using cold clean water and a mild vehicle wash soap.
- If insects, tar or other similar deposits have accumulated on your vehicle, wash it as soon as possible.
- If you drive on salted or dust controlled roads, or if you drive near the ocean, hose off the under carriage at least once a month.
- It is important that the drain holes in the lower edges of the doors and rocker panels be kept clear.
- If you detect any stone chips or scratches in the paint, touch them up immediately.
- If you do much driving on gravel roads, consider installing mud or stone shields behind each wheel.
- If your Nissan is damaged due to an accident or similar cause which destroys the paint and protective coating, have your vehicle repaired as soon as possible. The cost of such repairs is considered the responsibility of the owner.
- This corrosion warranty does not cover non-genuine sheet metal parts or damage caused by the installation of such non-genuine sheet metal parts.

SEE YOUR OWNER'S MANUAL FOR FURTHER DETAILS.



Security+Plus®

VEHICLE PROTECTION PLAN

LONG TERM MECHANICAL PROTECTION FOR YOUR NISSAN...

For extra peace of mind you can add Nissan's own Security+Plus® Vehicle Protection Plan which provides you with long term mechanical breakdown protection. Backed by Nissan, and designed exclusively for Nissan owners, Security+Plus® is available from your Nissan dealer in a variety of comprehensive coverages and a multitude of time and mileage intervals enabling you to customize a plan to suit your personal driving habits and length of ownership.

Just a few of its major features:

1. **With Security+Plus® you can choose from a full spectrum of term options to fit your ownership (time) and driving (mileage) needs.**
2. **Repairs are performed at participating Nissan dealerships throughout the U.S., excluding U.S. Territories. Repairs at these dealerships are performed by factory trained technicians using Genuine Nissan parts, to keep your vehicle in top running condition.**
3. **All new Security+Plus® Service Agreements are transferable to subsequent owners, thus ensuring flexibility of your investment and enhancing the resale value of your Nissan.**

YOU SIMPLY CAN'T GET BETTER LONG-TERM PROTECTION FOR YOUR MONEY THAN WITH NISSAN'S SECURITY+PLUS®!

For details, please contact your authorized Nissan Dealer or complete the attached business reply card (no postage necessary) and mail it to:

**Nissan Security+Plus® Headquarters
P.O. Box 685004
Franklin, TN 37068-9965**

We'll send you a complete information packet by return mail. Do it today! The quicker you act, the sooner you can have the full protection of a Nissan Security+Plus® Service Agreement.

NOTE: Security+Plus® Service Agreements for previously owned Nissan vehicles can only be purchased from your authorized Nissan dealership at the time of vehicle sale.

MEMO

MEMO

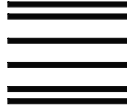

NO POSTAGE
NECESSARY
IF MAILED
IN THE
UNITED STATES

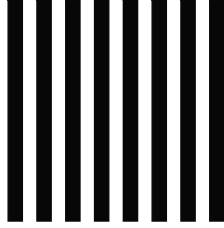

BUSINESS REPLY MAIL

FRANKLIN TN

PERMIT NO. 97

FIRST-CLASS MAIL

POSTAGE WILL BE PAID BY ADDRESSEE

NISSAN SECURITY + PLUS[®]
HEADQUARTERS
PO BOX 685004
FRANKLIN TN 37068-9965

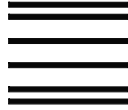

NO POSTAGE
NECESSARY
IF MAILED
IN THE
UNITED STATES

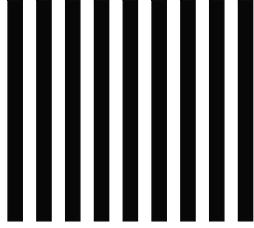

BUSINESS REPLY MAIL

FRANKLIN TN

PERMIT NO. 97

FIRST-CLASS MAIL

POSTAGE WILL BE PAID BY ADDRESSEE

NISSAN NORTH AMERICA INC
PO BOX 685003
FRANKLIN TN 37068-9970



NISSAN

PE11-020

NISSAN

8/31/2011

ATTACHMENT C



SERVICE BULLETIN

| | | |
|-----------------------------|-------------------------|-----------------------------|
| Classification: BR10-010 | Reference: NTB10-110 | Date: September 15, 2010 |
|-----------------------------|-------------------------|-----------------------------|

ALTIMA AND MAXIMA; LOW BRAKE FLUID WARNING LIGHT "ON" DIAGNOSTIC PROCEDURE

APPLIED VEHICLES: 2007-2011 Altima Coupe, Hybrid, Sedan (C/L32/HV)
2009-2011 Maxima (A35)

SERVICE INFORMATION

It is possible for brake pad wear to cause the fluid level in the master cylinder reservoir to decrease to the MIN level, turning "ON" the Low Brake Fluid Warning Light.

If you confirm that the warning light is illuminated, perform the following procedures to inspect the vehicle and determine the proper repair method.

WARRANTY NOTE: A low fluid level in the master cylinder reservoir due only to brake pad wear not caused by any defect is not warrantable.

INSPECTION

Use a scale to check the thickness of the front brake pads.

- View the brake pads through the caliper body inspection hole.

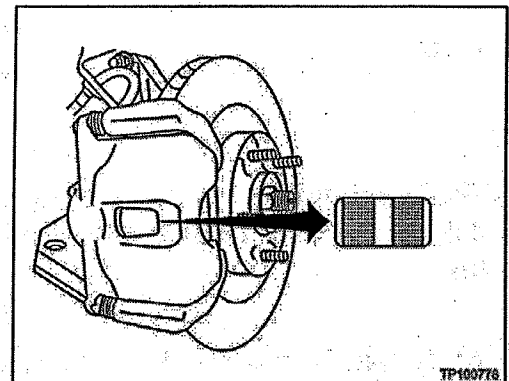

1. If the remaining brake pad lining thickness is:

Altima – 5.3mm or less

Maxima – 5.7mm or less

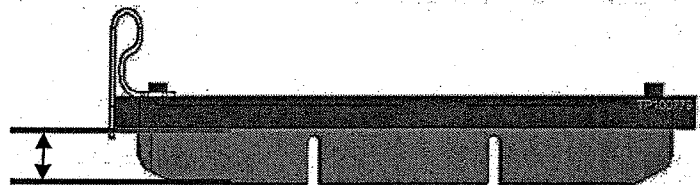

Nissan Bulletins are intended for use by qualified technicians, not 'do-it-yourselfers'. Qualified technicians are properly trained individuals who have the equipment, tools, safety instruction, and know-how to do a job properly and safely. NOTE: If you believe that a described condition may apply to a particular vehicle, DO NOT assume that it does. See your Nissan dealer to determine if this applies to your vehicle.

AND

The brake fluid level in the master cylinder fluid reservoir is at or near the **MIN** level line,

The drop in the brake fluid level is likely due to brake pad wear not caused by any defect.

ACTION: Add brake fluid to the reservoir.

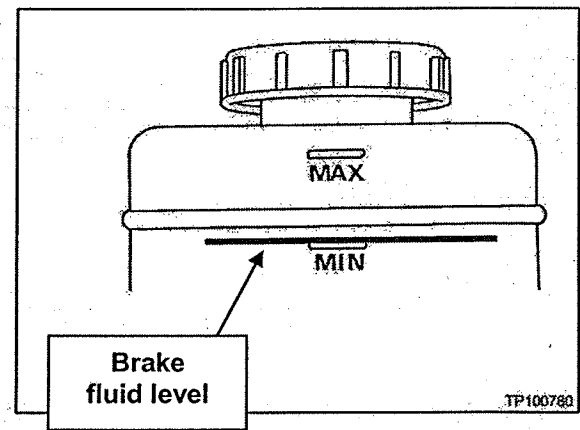

2. If the remaining brake pad lining thickness is:

Altima – More than 5.3mm

Maxima – More than 5.7mm

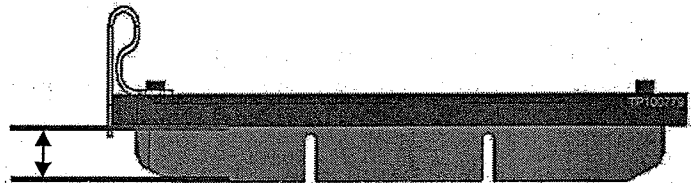

AND

The brake fluid level in the master cylinder fluid reservoir is at or below the **MIN** level line,

ACTION: Perform brake system inspections in accordance with the Electronic Service Manual (ESM) to determine the cause of the brake fluid level decrease.

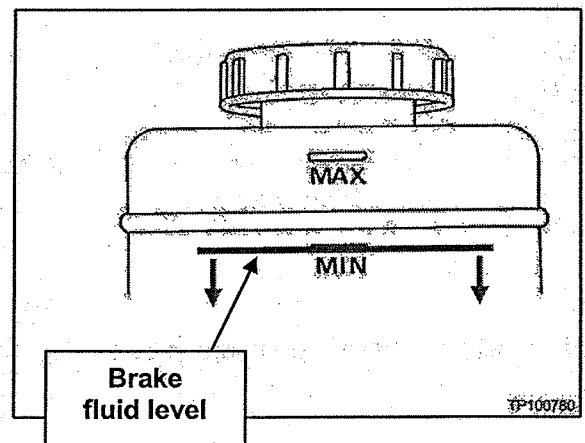

3. To determine if the front brake pads should be replaced, refer to the applicable ESM for front brake pad wear limit thickness information.

PE11-020

NISSAN

8/31/2011

ATTACHMENT D

(NON CONFIDENTIAL)

Analysis of Parts Returned @ USF



Analysis of Stock Available @ Bosch



NICKED PISTON ISSUE
Root Cause Analysis & Action Plan
Warranty Returns
August 2, 2007



Containment Actions

* 100% Visual Inspection of all TMC8's pistons (primary & secondary) by a third party company (Name: Fabris).



ARCHIVE ARCHIVE ARCHIVE ARCHIVE ARCHIVE ARCHIVE ARCHIVE ARCHIVE
ARCHIVE ARCHIVE ARCHIVE ARCHIVE ARCHIVE ARCHIVE ARCHIVE ARCHIVE
ARCHIVE ARCHIVE ARCHIVE ARCHIVE ARCHIVE ARCHIVE ARCHIVE ARCHIVE
ARCHIVE ARCHIVE ARCHIVE ARCHIVE ARCHIVE ARCHIVE ARCHIVE ARCHIVE
ARCHIVE ARCHIVE ARCHIVE ARCHIVE ARCHIVE ARCHIVE ARCHIVE ARCHIVE
ARCHIVE ARCHIVE ARCHIVE ARCHIVE ARCHIVE ARCHIVE ARCHIVE ARCHIVE
ARCHIVE ARCHIVE ARCHIVE ARCHIVE ARCHIVE ARCHIVE ARCHIVE ARCHIVE
ARCHIVE ARCHIVE ARCHIVE ARCHIVE ARCHIVE ARCHIVE ARCHIVE ARCHIVE
ARCHIVE ARCHIVE ARCHIVE ARCHIVE ARCHIVE ARCHIVE ARCHIVE ARCHIVE
ARCHIVE ARCHIVE ARCHIVE ARCHIVE ARCHIVE ARCHIVE ARCHIVE ARCHIVE
ARCHIVE ARCHIVE ARCHIVE ARCHIVE ARCHIVE ARCHIVE ARCHIVE ARCHIVE
ARCHIVE ARCHIVE ARCHIVE ARCHIVE ARCHIVE ARCHIVE ARCHIVE ARCHIVE
ARCHIVE ARCHIVE ARCHIVE ARCHIVE ARCHIVE ARCHIVE ARCHIVE ARCHIVE
ARCHIVE ARCHIVE ARCHIVE ARCHIVE ARCHIVE ARCHIVE ARCHIVE ARCHIVE
ARCHIVE ARCHIVE ARCHIVE ARCHIVE ARCHIVE ARCHIVE ARCHIVE ARCHIVE
ARCHIVE ARCHIVE ARCHIVE ARCHIVE ARCHIVE ARCHIVE ARCHIVE ARCHIVE

PE11-020

NISSAN

8/31/2011

ATTACHMENT E

(NON CONFIDENTIAL)

**Brake Master Cylinders
Part Number List**

| Part Number | Model | Application Detail | Note |
|--------------|----------------|--------------------|--|
| 46010-ET000 | Sentra | Manual Trans | |
| 46010-ET000C | Sentra | Manual Trans | "C" suffix created for B16 voluntary recall campaign |
| 46010-ET010 | Sentra | CVT | |
| 46010-ET010C | Sentra | CVT | "C" suffix created for B16 voluntary recall campaign |
| 46010-JA00A | Altima | CVT | |
| 46010-JA01A | Altima | Manual Trans | |
| 46010-JA02A | Altima, Maxima | CVT | |
| 46010-JA03A | Altima | Manual Trans | |

PE11-020

NISSAN

8/31/2011

ATTACHMENT F

(NON CONFIDENTIAL)

Altima Warranty Returns Dynamic Leakage Testing

March 11, 2010



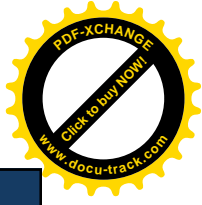
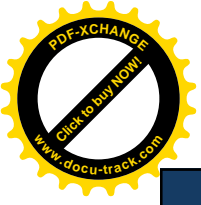

Nissan Altima/Maxima Warranty Analysis

Topics

- Returned Parts Analysis
- Customer Impact
- Summary Points



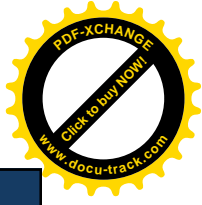
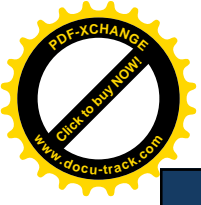

Customer Impact



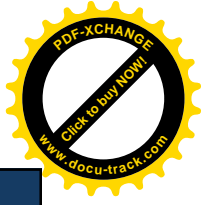

Weibull Analysis



PE11-020

NISSAN

8/31/2011

ATTACHMENT G

(NON CONFIDENTIAL)



NISSAN'S INVESTIGATION AND DECISION- MAKING PROCESS FOR POTENTIAL SAFETY ISSUES

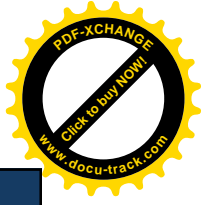
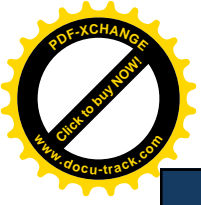

L32H Master Cylinder Isolation Seal Leak

Review of Sentra L32 Isolation Seal Leak

Chassis Systems Full Brakes, North America



BOSCH

1

Confidential | AF/EAA | 6/24/2008 | © 2008 Robert Bosch LLC and affiliates. All rights reserved.



B16 (Sentra)
Brake Master Cylinder issue
NNA/NMEX

May 27th, 2008

Draft – Privileged and Confidential



Appendix

Draft – Privileged and Confidential

Leakage of brake fluid on B16' s brake master cylinder

May 20th , 2008

Chronology of Rear Isolation Seal Leaks



Problem Statement



L32H Master Cylinder Isolation Seal Leak

Effect on Vehicle and Warning Pattern

Chassis Systems Brakes



BOSCH

10

Strictly confidential | AF/EAA | 06/24/08 | © Robert Bosch GmbH 2008. All rights reserved, also regarding any disposal, exploitation, reproduction, editing, distribution, as well as in the event of applications for industrial property rights.

Design and Supplier Comparison Nissan NA Programs



End-of-Line Testing Comparison



Warranty Prognosis





B16 (Sentra) Brake Master Cylinder Post Counter Measure

Technical Meeting 10/7/2009

NMEX QA / NNA FQA

Ver.3

Draft – Privileged and Confidential



Appendix



B16 (Sentra) Brake Master Cylinder Post Counter Measure

Technical Committee 10/20/2009

NNA FQA

Ver.2

Draft – Privileged and Confidential



Appendix

PE11-020

NISSAN

8/31/2011

List of Actions

| Title/File Name | Pages | Start Date | End Date | Subject | Objective | Group Responsible | Summary |
|-------------------|-----------|------------|-----------|---|---|-------------------|--|
| NA-PRO-2007-00728 | D1-D124 | 7/17/2007 | 9/25/2007 | 2007 L32 Altima Master Cylinder Leaking | Investigation into low brake reservoir fluid and brake pedal to the floor. | FQI | Investigation found multiple root causes: 1) Float tunnel proximity to weld seam. 2) Nicked pistons. 3) Oversized bore. |
| NA-PRO-2008-00339 | D125-D265 | 3/3/2008 | 8/12/2008 | 2008 L32 Brake Fluid Leaking from Master Cylinder After 8-16-2007 C/M | Investigation into leaking brake master cylinders produced after the 8-2007 C/M | FQI | Root cause determined to be scratched pistons, caused by peening punch at the supplier creating a slight burr on the body machin |
| NA-PRO-2008-00534 | D266-D303 | 6/10/2008 | 8/13/2008 | L32 2007-2008MY Master Cylinder Leak | Investigation into brake master cylinder leaking into the brake booster | FQI | Investigation found contamination at production line (Bosch) and damaged pistons at both Tier 2 supplier and Bosch contributed to the leakage. Countermeasures put into place in July 2008 involved improving cleanliness at production line and a change in the tooling to prevent piston damage. |
| NA-PRO-2008-00968 | D304-D326 | 7/14/2008 | 8/12/2008 | 2008 L32 Brake Warning Light on at PDI - Master Cylinder Leak | Investigation involving brake warning light on at PDI | FQI | Single incident. Part was tested with 24 hr vacuum test and bubble tested at 5 and 10 psi with no leakage and no pressure loss. No defect could be found. |
| NA-PRO-2010-02581 | D327-D342 | 9/30/2010 | 9/30/2010 | Altima (CL32,L32,L32H) and Maxima (A35) - Brake Fluid Low TSB | Brake light on warning due to pad wear | FQI | TSB released to address brake light on due to pad wear |