

EA09-006

TOYOTA

2/19/2010

ATTACHMENT 11

11-A-1

■ ABS with EBD & ACTIVE TRAC (TRAC) & VSC SYSTEM

1. General

- The ABS with EBD & Active TRAC (TRAC) & VSC system is provided as standard equipment on all models. The TRAC function has been adopted the conventional function on the 2WD model and Active TRAC function on the 4WD model.
- The active brake booster has been newly adopted to realize excellent brake control while the VSC system is operated.

2. Function

The table below gives an outline of the functions that comprise the ABS with EBD & Active TRAC (TRAC) & VSC system.

Function	Outline	2WD	4WD
ABS with EBD Function	This function controls the brake fluid pressure acting on the wheel cylinders to help prevent the wheels locking and thus helps to maintain good directional stability and steerability on slippery surfaces and during panic braking. Based on the signals received from the speed sensors, the EBD detects the difference in the speed between the front and rear wheels, and operates the brake actuators to control the fluid pressure in order to effect an appropriate front/rear wheel braking force distribution in accordance with the vehicle's driving conditions. This functions like an electronic load-sensing proportioning valve. For details, refer to see page 105.	○	○
TRAC Function	This function totally controls the engine torque control and the braking of the driving wheels (rear wheels). It helps to avoid slippage of the driving wheels that tends to happen during starting and acceleration and to maintain an optimal driving force according to the road surface conditions.	○	○ (2WD Mode)
Active TRAC Function	During rugged offroad driving, this function controls the engine output and the brake fluid pressure that is applied to the slipping wheel, and distributes the drive force that would have been lost through the slippage to the remaining wheels in order to achieve a LSD (Limited Slip Differential) effect. As a result, the vehicle's offroad drivability and ability to free itself from the mogul have been improved. For details, refer to see page 106.	—	○ (4WD Mode)
VSC Function	If the vehicle is about to experience side slips during an unexpected occurrence, such as a sudden change in the road conditions or while making an emergency avoidance maneuver, this function automatically controls the brake fluid pressure applied to the wheels and regulates the engine output in order to help maintain traction. As a result, the vehicle's offroad drivability and ability to free itself from the mogul have been improved. For details, refer to see page 108.	○	○

3. System Diagram

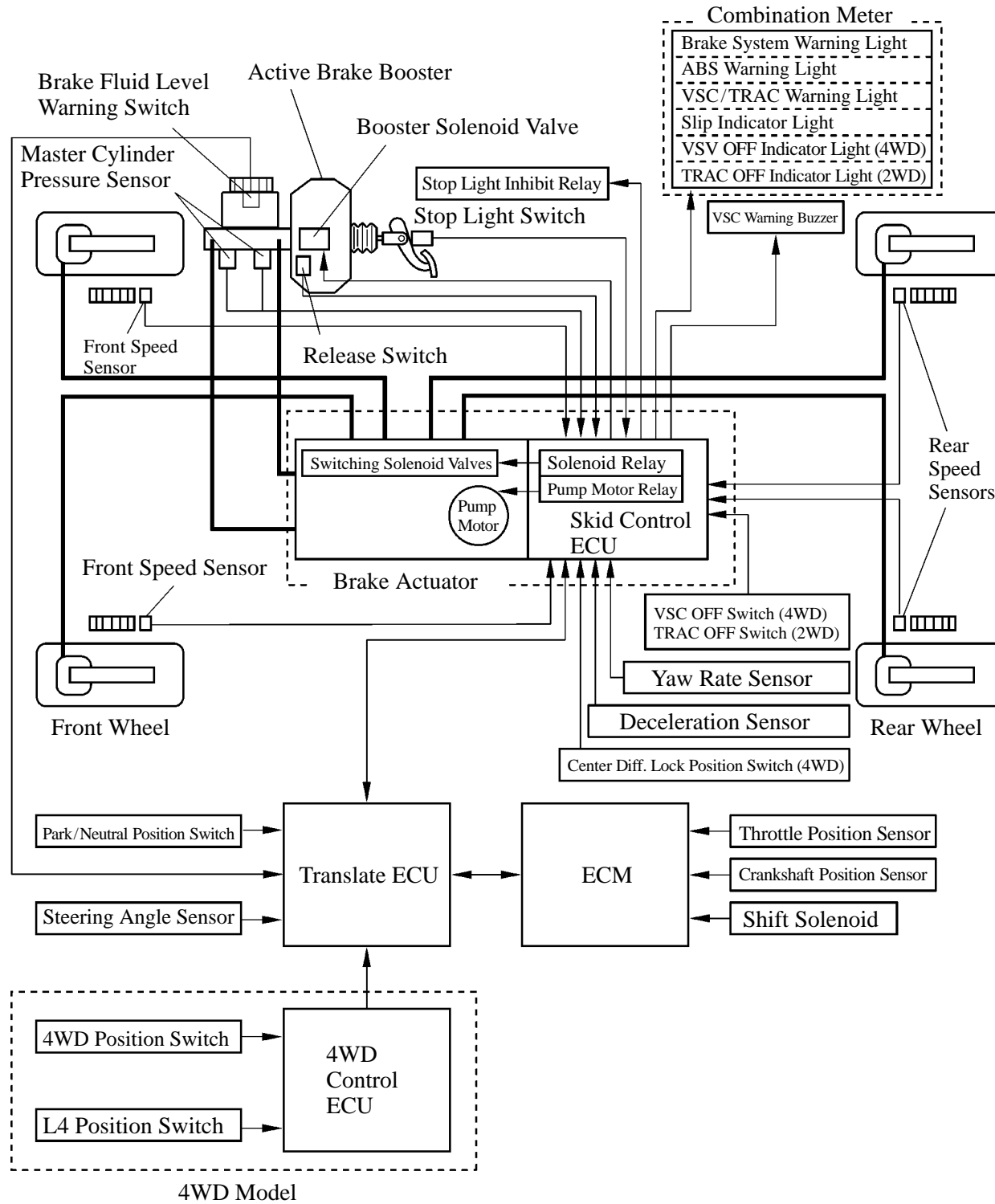

4. Outline of EBD Control

General

The EBD control utilizes ABS, realizing the proper brake force distribution between front and rear wheels in accordance with the driving conditions.

The distribution of the brake force, which was performed mechanically in the past, is now performed under electrical control of the skid control ECU, which precisely controls the brake force in accordance with the vehicle's driving conditions.

Front/Rear Wheels Brake Force Distribution

If the brakes are applied while the vehicle is moving straight forward, the transfer of the load reduces the load that is applied to the rear wheels. The skid control ECU determines this condition by way of the signals from the speed sensor, and regulates the brake actuator in order to optimally control the distribution of the brake force to the rear wheels.

For example, the amount of the load that is applied to the rear wheels during braking varies whether or not the vehicle is carrying a load. The amount of the load that is applied to the rear wheels also varies in accordance with the extent of the deceleration. Thus, the distribution of the brake force to the rear is optimally controlled in order to effectively utilize the braking force of the rear wheels under these conditions.

► EBD Control Concept ◀

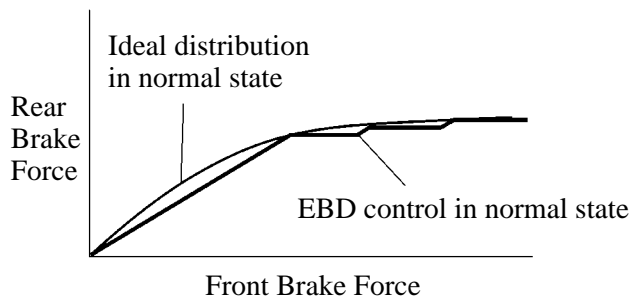
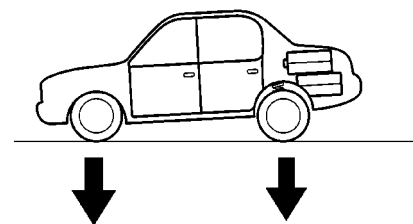
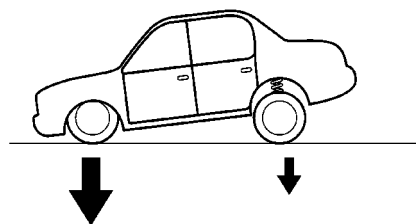

Normal State

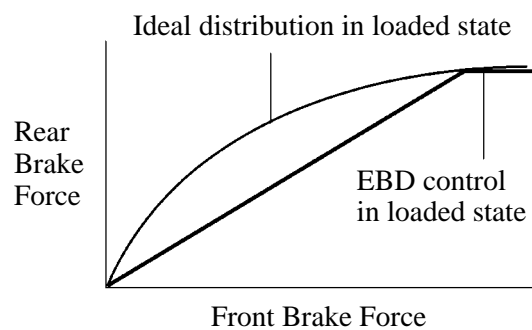

Load State

5. Outline of Active TRAC Function

General

If a tire slips while the vehicle is being driven on a snow-covered road or offroad, the function of the differential gear causes a large amount of drive force to be applied to the tire that is slipping.

The Active TRAC function helps restrain the slippage by controlling the engine output and brake fluid pressure that is applied to the slipping wheel, and distributes the drive force that would have been lost through the slippage to the remaining wheels in order to achieve an effect that is similar to the LSD (Limited Slip Differential).

It independently controls the brake hydraulic pressure to the four wheels in accordance with the extent of the slippage at the wheels, as detected by the skid control ECU.

The effectiveness of the control of this function is as follows:

- Offroad drivability that is equivalent to having the center and rear differentials locked has been realized.
- This function made the operation of the differential lock switches basically unnecessary to ensure the ease of driving.
- While realizing the offroad drivability that is equivalent to having the center and rear differentials locked, as compared to the differential gear in the locked state, the essential function of the differential gear itself ensures the ease of nimble steerability.
- When the transfer shift lever is in the L4 range, moving the A/T shift lever to the L range causes the center differential to lock automatically, further improving the vehicle's offroad drivability.

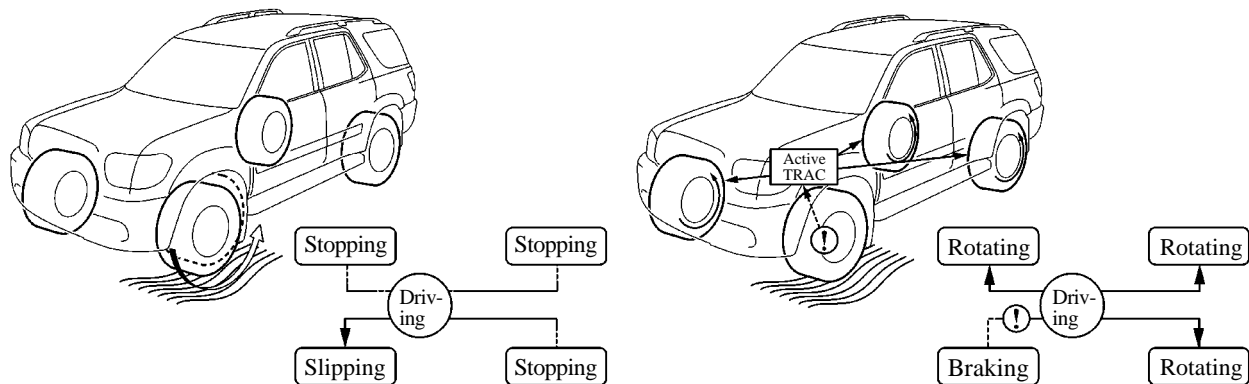

**without Active TRAC
(Center Differential Free)**

**with Active TRAC
(Center Differential Lock)**

Outline of Control Performance

The Active TRAC function consists of the following two controls: the brake control and the engine output control.

1) Brake Control

Based on the vehicle speed that has been calculated from the speeds of the wheels and the signal from the deceleration sensor, the skid control ECU computes the target control speed in accordance with the transfer range.

The ECU compares the target control speed and the speeds of the wheels to determine whether or not a slippage exists. Upon detecting a slippage, the ECU controls the solenoid valve of the brake actuator to control the brake fluid pressure that is applied to the slipping wheel. When the wheel speed becomes lower than the target control speed, the ECU stops controlling the brake fluid pressure.

As shown in the table below, the target control speed and the brake fluid pressure control vary in accordance with the transfer range.

Transfer Range	Control Performance		Outline
	Target Control Speed	Brake Control	
H2 (for ordinary driving)	Vehicle speed + Slip rate	Gradual fluid pressure control	Control designed to ensure the ease of driving on low- friction roads, dirt roads, and general roads.
H4 (for ordinary driving)	Vehicle speed + Slip rate (H range set value)	Gradual fluid pressure control	Control designed to ensure the ease of driving on low-friction roads, dirt roads, and general roads.
L4, L4L (for rocky road or offroad driving)	Vehicle speed + Slip rate (L range set value)	Sudden fluid pressure control	Control designed for rugged offroad driving.

2) Engine Output Control

The engine output control of the Active TRAC function varies in accordance with the range in which the transfer is engaged. When the transfer is engaged in the H2 or H4 range, this function effects engine output control on a stability-priority in accordance with the amount of pedal effort applied to the accelerator pedal, when the transfer engaged in the L4 range, it effects engine output control on a drivability-priority basis.

NOTE: When the brake control of the Active TRAC function is operating continuously while the vehicle is being driven on a slippery surface, the temperature of the brake actuator increases. If the computed brake actuator temperature is too high, the skid control ECU causes the buzzer to sound intermittently to inform the driver.

After the buzzer has sounded, the brake control takes over. If the temperature of the brake actuator increases even further, the VSC/TRAC warning light illuminates and the buzzer sounds, and the operation of the Active TRAC function is momentarily interrupted to protect the brake actuator. Although the Active TRAC function does not operate at this time, the vehicle can be driven normally.

When the temperature of the brake actuator decreases, the VSC/TRAC warning light turns OFF, and the Active TRAC function is automatically restored to an operating state.

6. Outline of VSC System

General

The followings are two examples that can be considered as circumstances in which the tires overcome their lateral grip limit.

- When the front wheels lose grip in relation to the rear wheels (strong understeer tendency).
- When the rear wheels lose grip in relation to the front wheels (strong oversteer tendency).

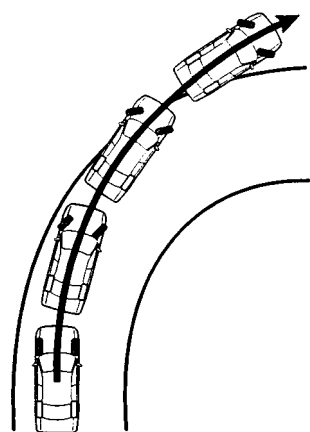

151CH17

Strong Understeer Tendency

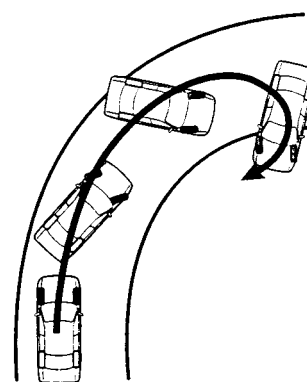

151CH16

Strong Oversteer Tendency

Method for Determining the Vehicle Condition

To determine the condition of the vehicle, sensors detect the steering angle, vehicle speed, vehicle's yaw rate, and the vehicle's lateral acceleration, which are then calculated by the skid control ECU.

1) Determining Understeer

Whether or not the vehicle is in the state of understeer is determined by the difference between the target yaw rate and the vehicle's actual yaw rate.

When the vehicle's actual yaw rate is smaller than the yaw rate (a target yaw rate that is determined by the vehicle speed and steering angle) that should be rightfully generated when the driver operates the steering wheel, it means the vehicle is making a turn at a greater angle than the loss of travel. Thus, the ECU determines that there is a large tendency to understeer.

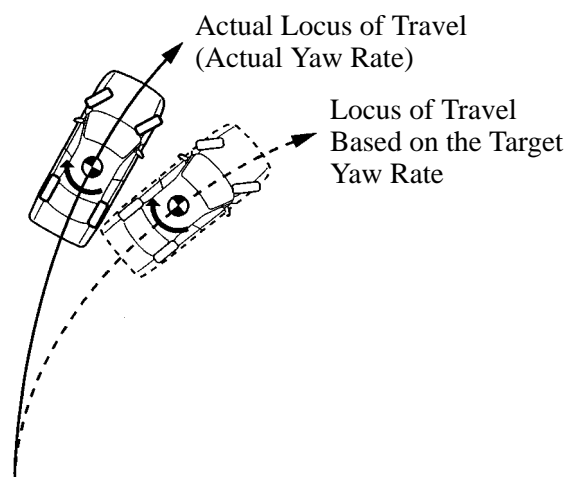

151CH19

2) Determining Oversteer

Whether or not the vehicle is in the state of oversteer is determined by the values of the vehicle's slip angle and the vehicle's slip angular velocity (time-dependent changes in the vehicle's slip angle). When the vehicle's slip angle is large, and the slip angular velocity is also large, the ECU determines that the vehicle has a large oversteer tendency.

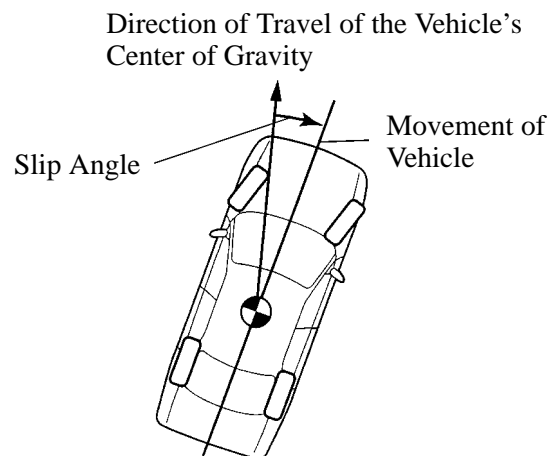

151CH18

Method of VSC Operation

When the skid control ECU determines that the vehicle exhibits a tendency to understeer or oversteer, it decreases the engine output and applies the brake of a front or rear wheel to control the vehicle's yaw moment.

The basic operation of the VSC is described below. However, the control method differs depending on the vehicle's characteristics and driving conditions.

1) Dampening a Strong Understeer

When the skid control ECU determines that the vehicle exhibits a strong tendency to understeer, depending on the extent of that tendency, it controls the engine output and applies the brake of the inside rear wheel, thus providing the vehicle with an understeer control moment, which helps dampen its tendency to understeer. Also, depending on whether the brake are ON or OFF and the condition of the vehicle, there are circumstances in which the brake might not be applied to the wheels even if that wheel are targeted for braking.

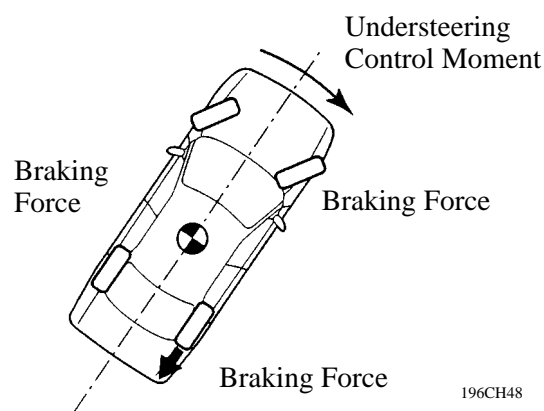

196CH48

Making a Right Turn

2) Dampening a Strong Oversteer

When the skid control ECU determines that the vehicle exhibits a strong tendency to oversteer, depending on the extent of that tendency, it controls the engine output and applies the brake of the front wheel of the outside of the turn, thus generating an inertial moment in the vehicle's outward direction, which helps dampen its tendency to oversteer.

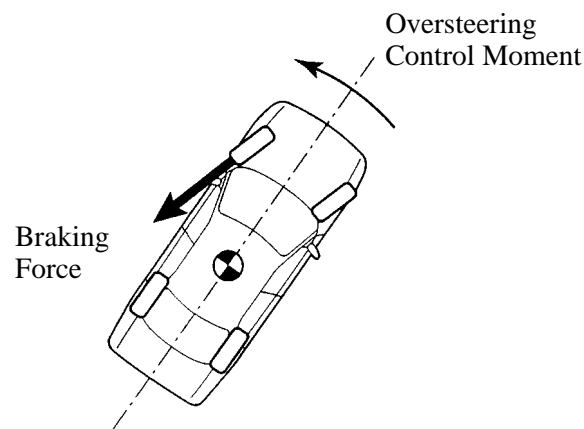

196CH49

Making a Right Turn

7. Layout of Main Components

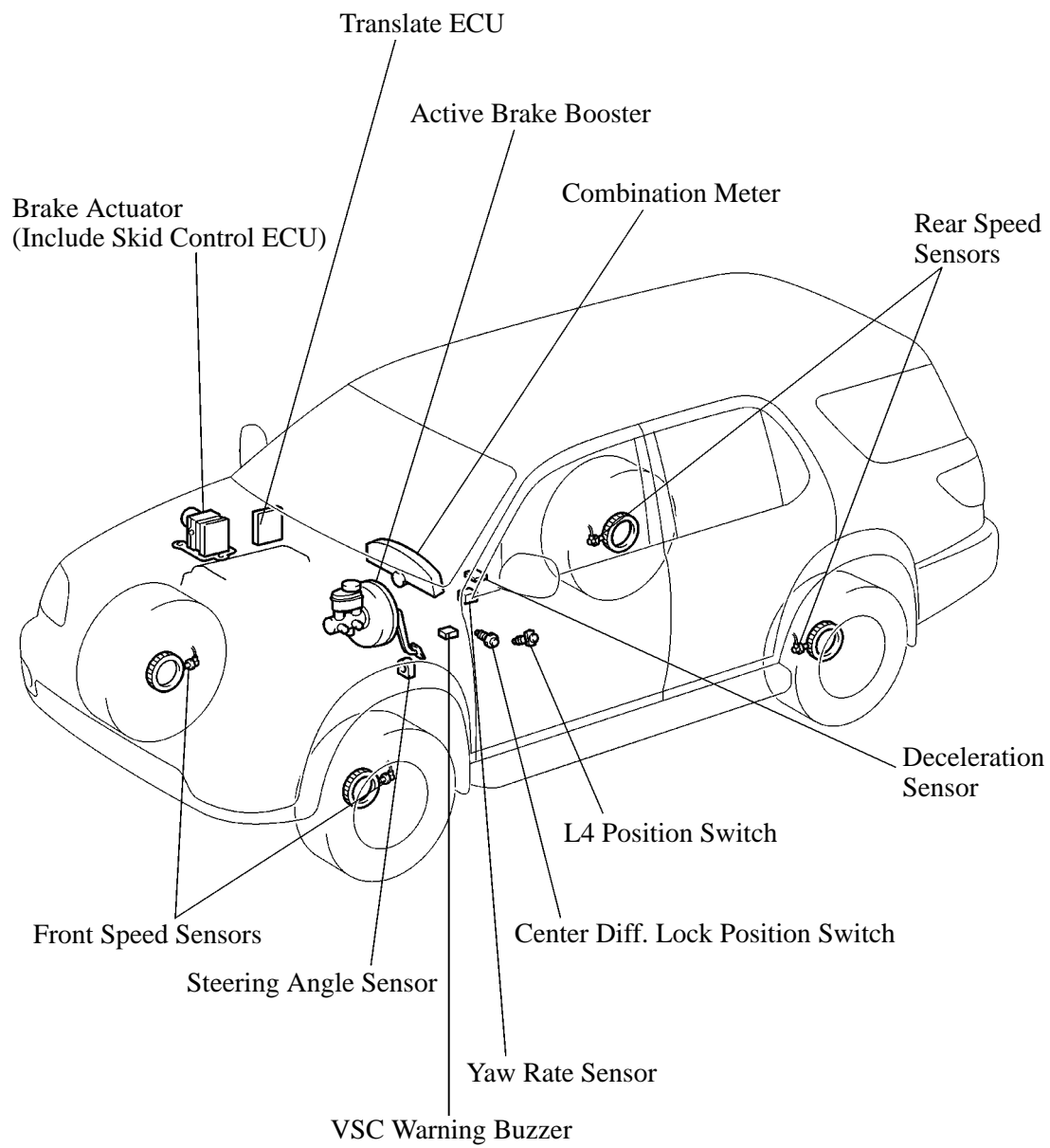

8. Function of Main Components

Components		Function
Warning Light and Indicator Light	ABS Warning Light	Lights up to alert the driver when the skid control ECU detects the malfunction in the ABS system.
	Brake System Warning Light	Lights up together with the ABS warning light to alert the driver when the skid control ECU detects the malfunction not only in the ABS but also in the EBD control.
	VSC/TRAC Warning Light	Lights up to alert the driver when the skid control ECU detects the malfunction in the active TRAC/TRAC system or the VSC system.
	Slip Indicator Light	Blinks to inform the driver when the active TRAC/TRAC system or the VSC system is operated.
	VSC OFF Indicator Light*1	Lights up to inform the driver when the VSC system is turned OFF by the VSC OFF switch.
	TRAC OFF Indicator Light*2	Lights up to inform the driver when the TRAC system is turned OFF by the TRAC OFF switch.
ECM		Sends the throttle valve opening angle signal, shift position signal, etc., to the skid control ECU via the translate ECU.
Translate ECU		Converts each different communication system used by the skid control ECU, 4WD control ECU, and ECM, then transmit the information.
4WD Control ECU*1		Sends the signal of the center differential lock indicator light (ON, Blink, or OFF) to skid control ECU via the translate ECU.
Skid Control ECU		Judges the vehicle driving condition based on signals from each sensor, and sends brake control signal to the brake actuator. Also transmits the control information to the ECM.
	Pump Motor Relay	Supply power to the pump motor in the actuator.
	Solenoid Relay	Supply power to the solenoid valve in the actuator.
Brake Actuator		Changes the fluid path based on the signals from the skid control ECU during the operation of the ABS with EBD & TRAC & VSC system, in order to control the fluid pressure that is applied to the wheel cylinder.
Master Cylinder Pressure Sensor		Detects the master cylinder pressure.
Booster Solenoid Valve		When the VSC system is activated, this solenoid operates in accordance with the signals from the skid control ECU to boost the hydraulic pressure to the wheel cylinders.
Release Switch		Detects the brake pedal depressing.
Stop Light Inhibit Relay		Because the brake pedal could move down when the VSC system is activated even though the driver is not depressing the brake pedal, this relay prevents the stop light from turning ON.
VSC OFF Switch*1		Turns only the VSC system inoperative.
TRAC OFF Switch*2		Turns only the TRAC system inoperative.
Speed Sensor		Detects the wheel speed of each of four wheels.
Brake Fluid Level Warning Switch		Detects the brake fluid level.
VSC Warning Buzzer		Emits an intermittent sound to inform the driver that the ECU detects the strong understeer tendency or strong oversteer tendency.
Yaw Rate Sensor		Detects the vehicle's yaw rate.
Deceleration Sensor		Detects the vehicle's acceleration in the lateral directions.
Steering Angle Sensor		Detects the steering direction and angle of the steering wheel.
4WD Position Switch*1		Detects the driving mode (4WD).
Center Diff. Lock Position Switch*1		Detects the center differential lock state.
L4 Position Switch*1		Detects the driving mode (L4).
Throttle Position Sensor		Detects the throttle valve opening angle.
Crankshaft Position Sensor		Detects the engine speed signal.

*1: 4WD Models

*2: 2WD Models

EA09-006

TOYOTA

2/19/2010

ATTACHMENT 11

11-A-2

■ BRAKE CONTROL SYSTEM
(ABS with EBD, Brake Assist, A-TRAC/ TRAC and VSC System)

1. General

- Brake Assist system has been adopted.
- The pedal stroke speed sensor has been adopted for brake assist control.
- The deceleration sensor that is provided for the brake control system (ABS with EBD, Brake Assist, A-TRAC/TRAC, and VSC system) has been integrated in the yaw rate sensor.
- The VSC OFF switch that was used on the 4WD model has been discontinued. Due to this, cancellation of VSC system using VSC OFF switch is not available. However, in case of locking the center differential, VSC system will be cancelled automatically.

2. System Diagram

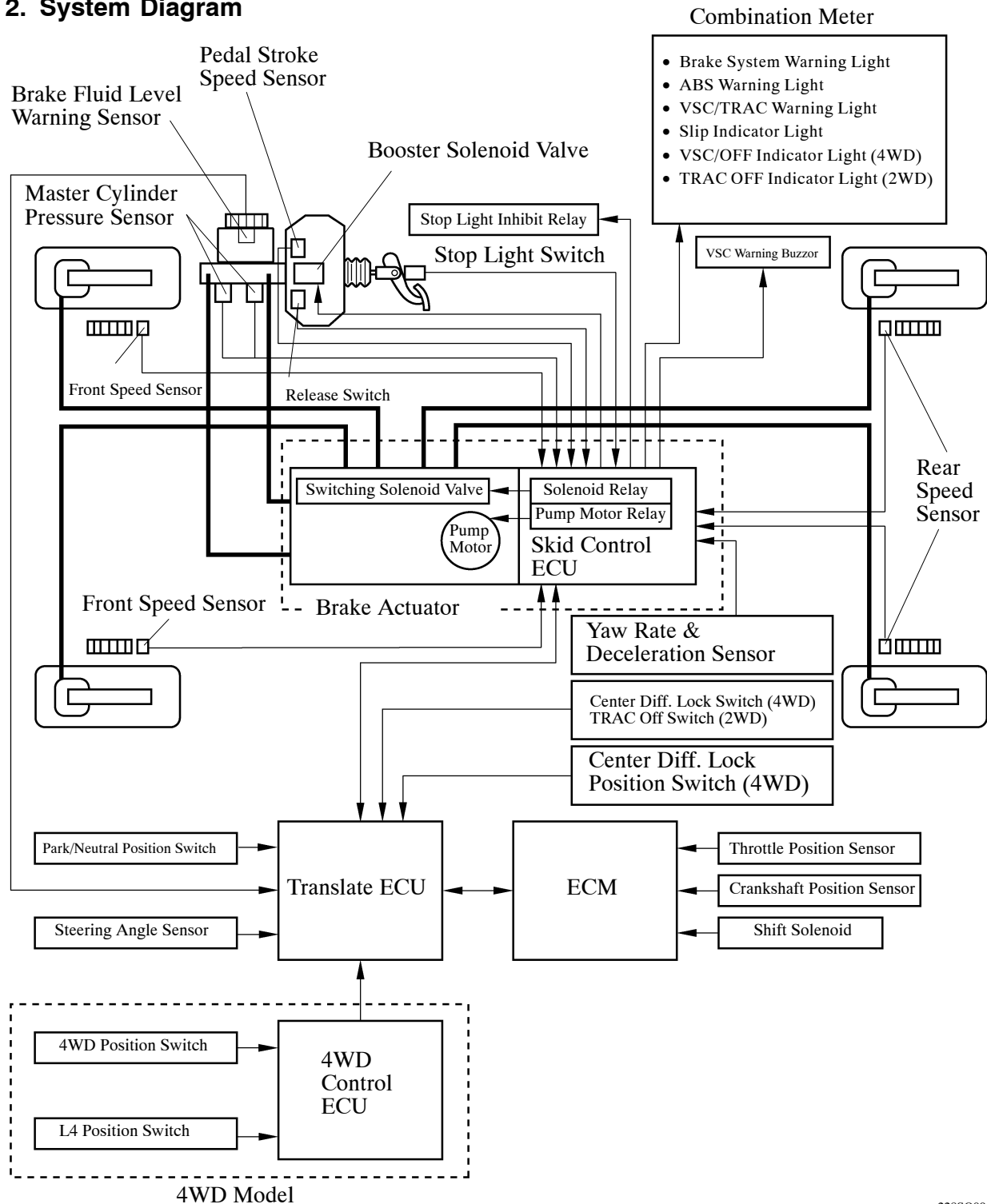

3. Layout of Main Components

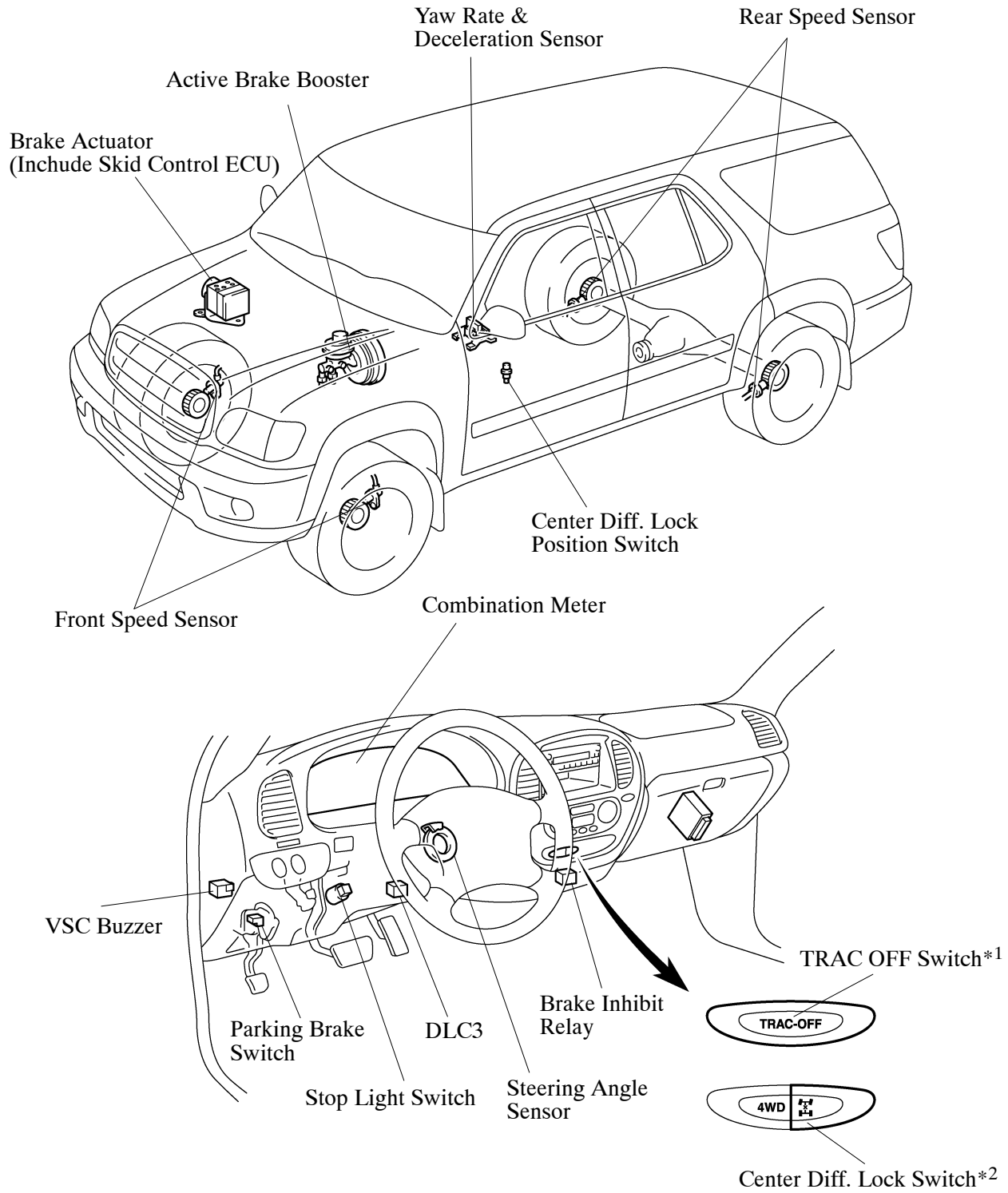

*2: Only for 2WD Model
 *1: Only for 4WD Model

4. Outline of Brake Assist System

- The Brake Assist System interprets a quick push of the brake pedal as emergency braking and supplements the braking power applied if the driver has not stepped hard enough on the brake pedal. In emergencies, drivers, especially inexperienced ones, often panic and do not apply sufficient pressure on the brake pedal.

Based on the signals from the master cylinder pressure sensor, the skid control ECU calculates the speed and the amount of the brake pedal application and then determines the intention of the driver to make an emergency braking. If the skid control ECU determines that the driver intends emergency braking, the system activates the brake actuator to increase the brake fluid pressure, which increases the braking force.

The Brake Assist System in combination with ABS helping draw the vehicle's brake performance.

A key feature of Brake Assist system is that the timing and the degree of braking assistance are designed to ensure that the driver does not discern anything unusual about the braking operation. When the driver intentionally eases up on the brake pedal, the system reduces the amount of assistance it provides.

► In case that the driver's depressing force is small when applying emergency braking ◀

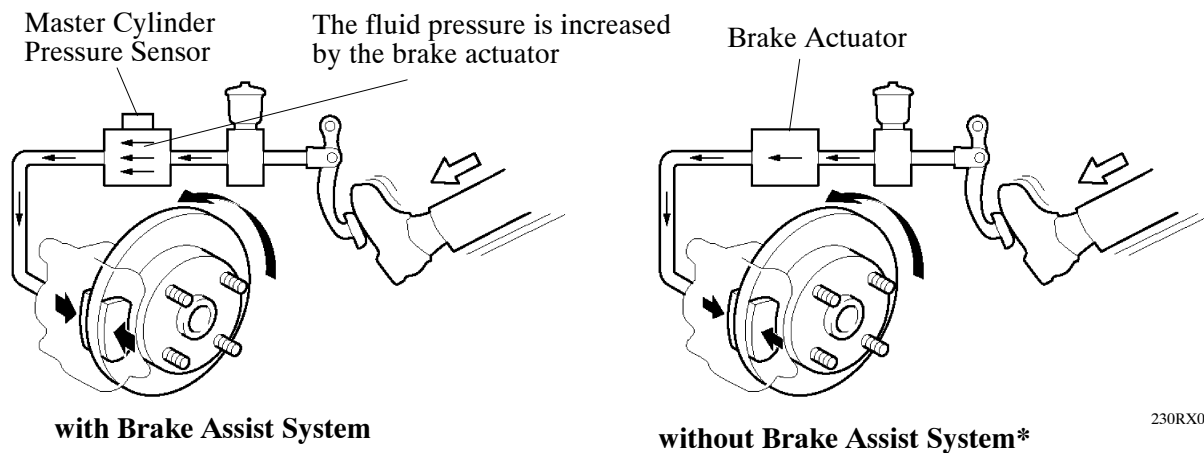

*: The basic performance of the brake is the same as of the model with the brake assist system.

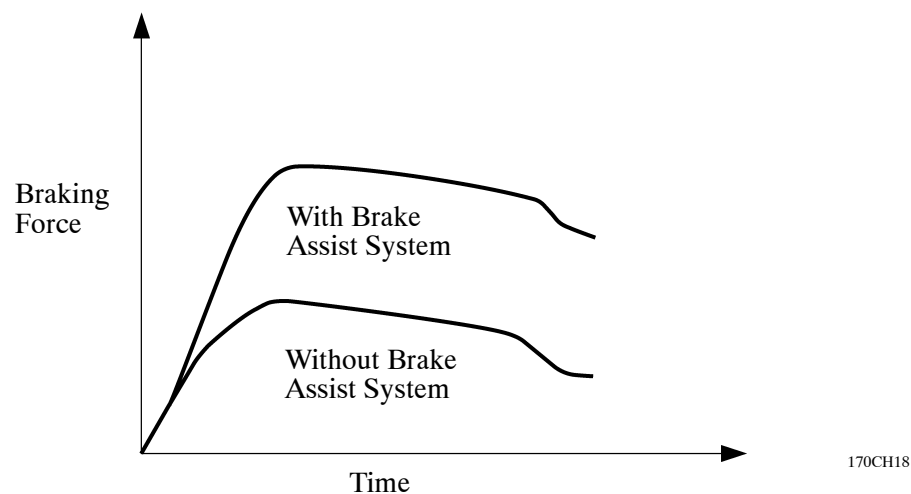

Service Tip

When this system is activated, the brake pedal could shudder, which is a normal occurrence of the system in operation and should not be considered a malfunction.

- If worst comes to worst and the brake booster has failed, it is necessary for a driver to apply more brake depressing force than usual. However, in this system, the skid control ECU detects the failure of the brake booster and actuates the brake actuator to assist the driver's brake depressing force.

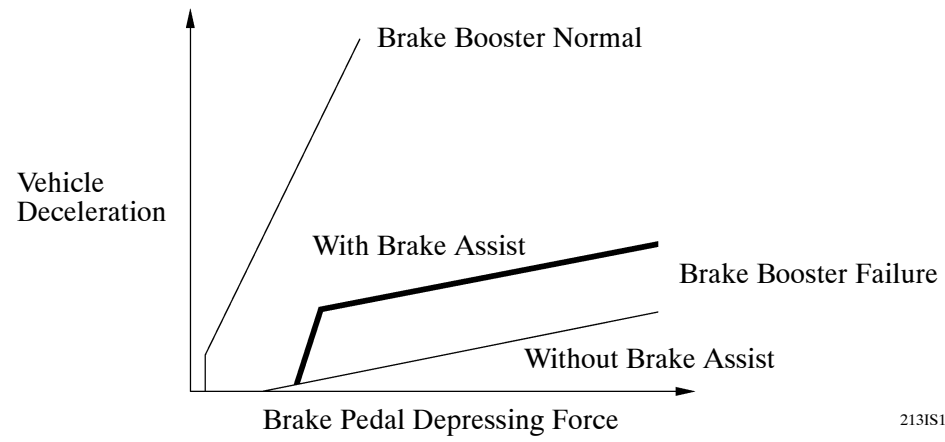

5. Construction and Operation

Active Brake Booster

1) General

- The active brake booster is used.
- The basic construction and operation are the same as the '02 model, However, along with the additional function of the brake assist system, a pedal stroke speed sensor that detects the stroke of the push rod of the active brake booster, has been newly adopted.
- This sensor detects a failure in the active brake booster to activate the brake assist system, which assists the braking force.

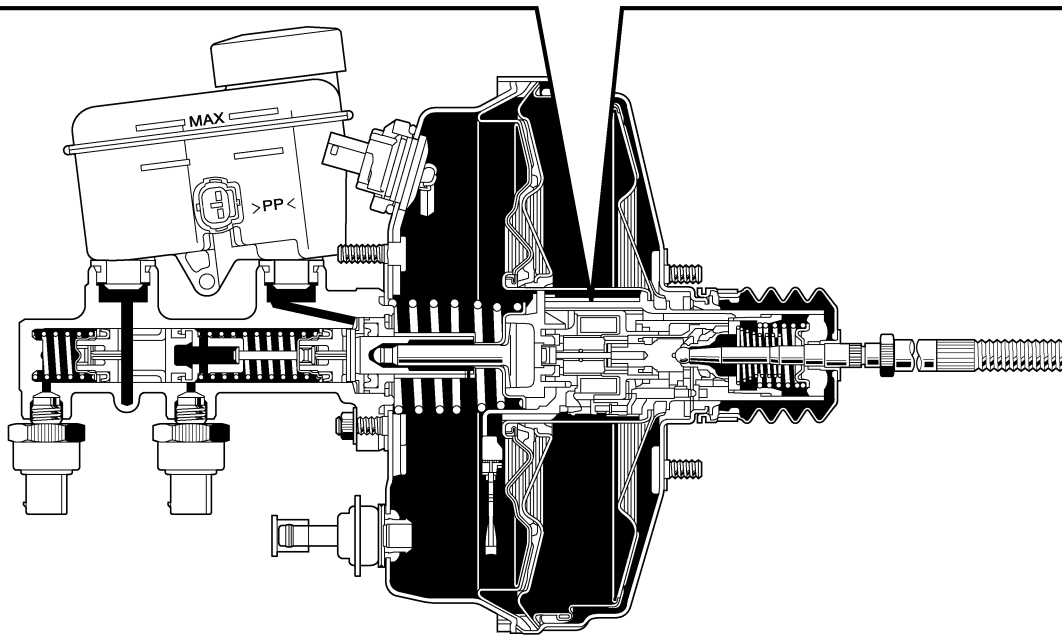
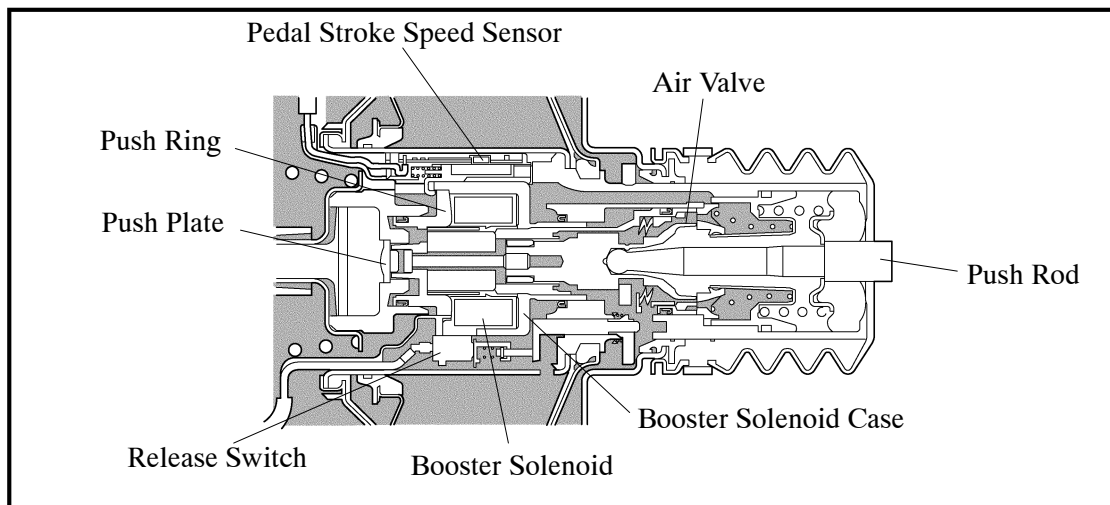

2) Pedal Stroke Speed Sensor

- This sensor consists of one magnet that act in unison with the movement of the push rod, and a Hall IC that is fixed in place. The Hall IC detects the changes in the magnetic flux density that are caused by the movement of the magnets (movement of the push rod) and outputs them to the skid control ECU. As a result, the skid control ECU detects the distance “a” indicated in the diagram below.
- The skid control ECU determines the failure of the brake booster based on the distance “a” and the master cylinder pressure value.
Zero “a” distance + low master cylinder pressure = brake booster failure

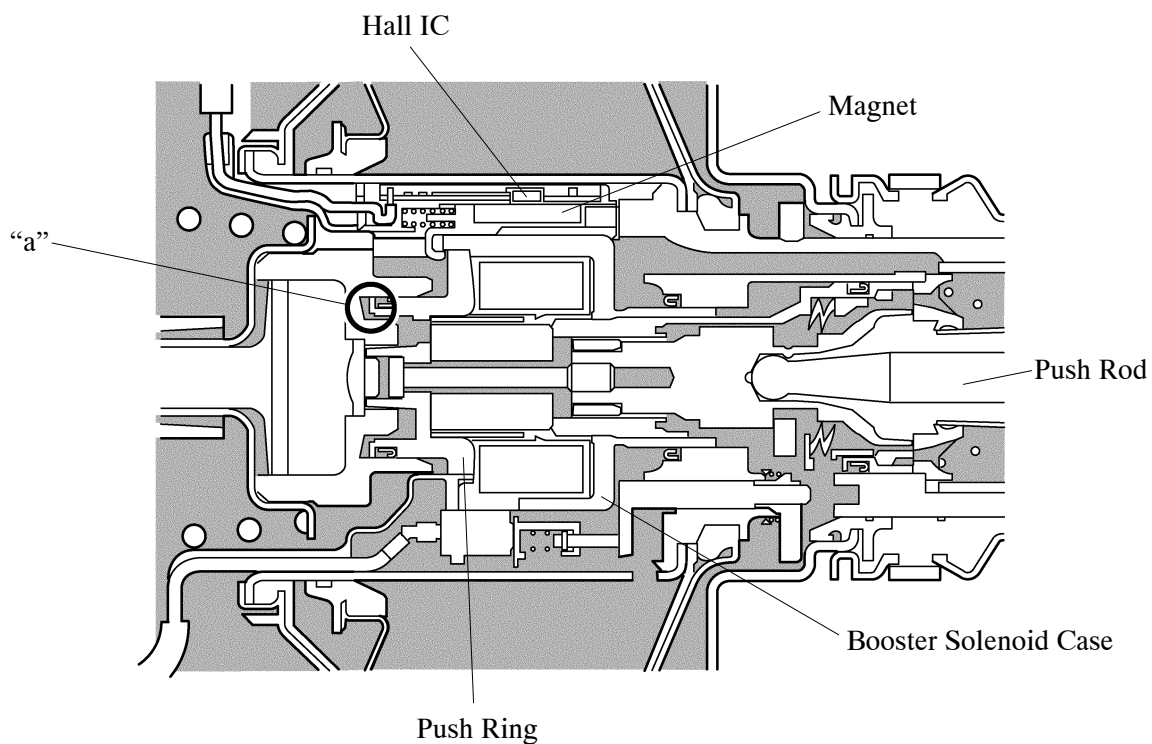

213IS12

Brake Assist Operation

- The fluid pressure that has been generated by the pump in the brake actuator is directed to the wheel cylinders. By applying a greater fluid pressure than the master cylinder, a greater braking force is achieved.
- Even if the brake booster fails, the skid control ECU activates the pump in the brake actuator and applies a greater fluid pressure than the master cylinder in order to achieve a greater braking force.

► System Diagram ◀

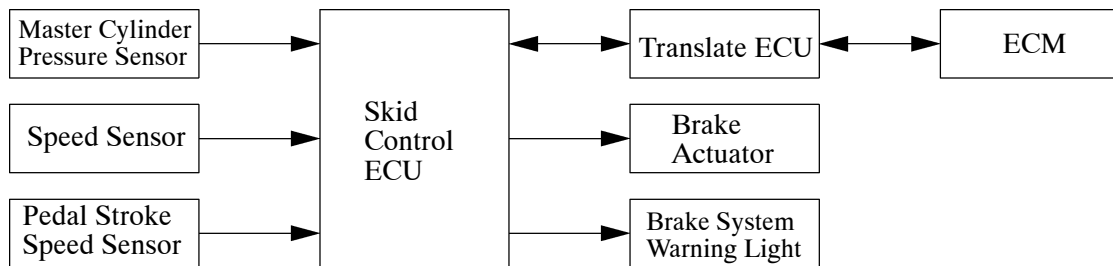

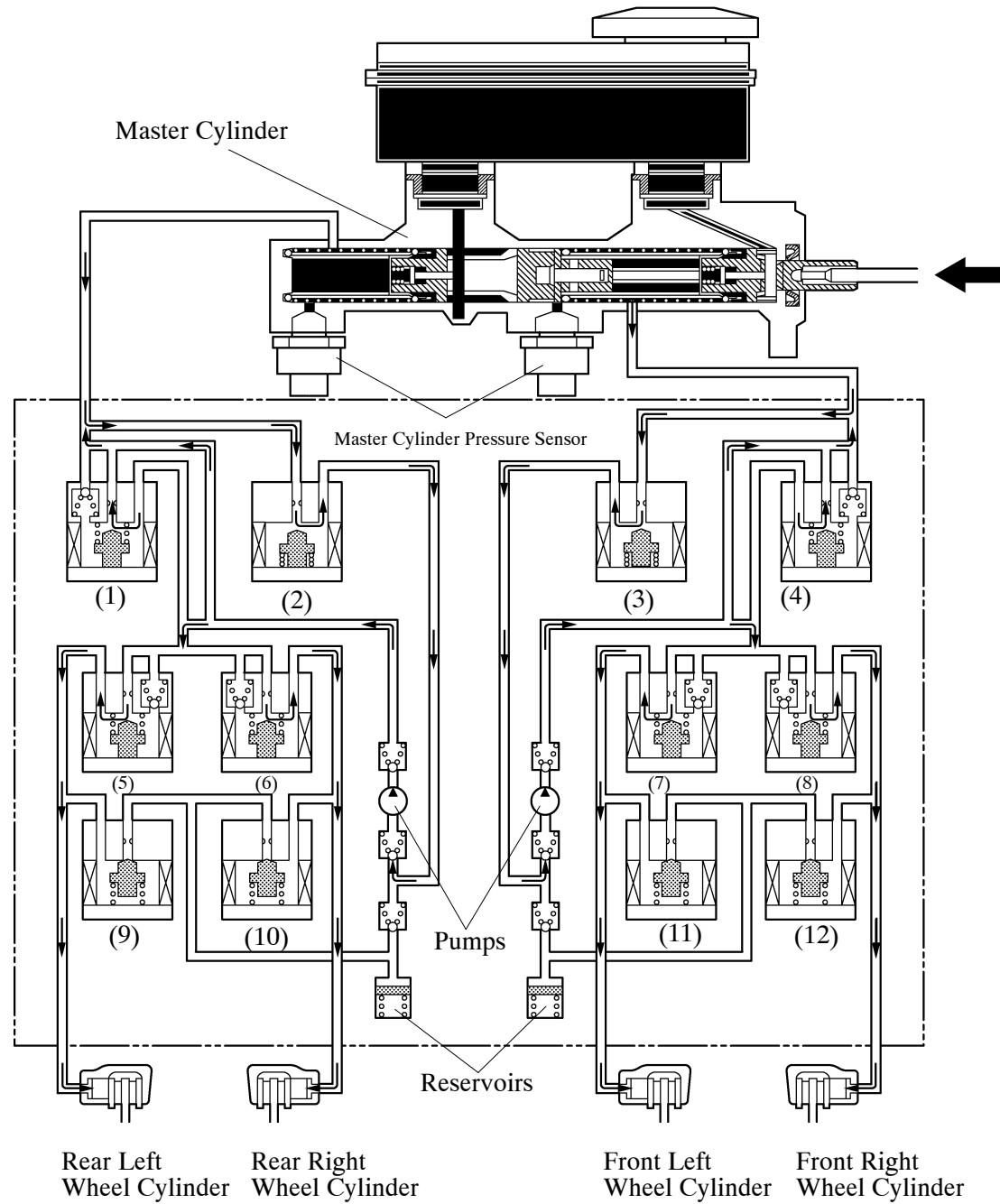

228SQ14

Item		Brake Assist Not Activated	Brake Assist Activated
(1), (4)	Master Cylinder Cut Solenoid Valve Port: (A), (D)	OFF (Open)	OFF (Open)
(2), (3)	Reservoir Cut Solenoid Valve Port: (B), (C)	OFF (Close)	ON (Open)
(5), (6), (7), (8)	Pressure Holding Valve Port: (E), (F), (G), (H)	OFF (Open)	OFF (Open)
(9), (10), (11), (12)	Pressure Reduction Valve Port: (I), (J), (K), (L)	OFF (Close)	OFF (Close)

Skid Control ECU

1) Self-Diagnosis

- If the skid control ECU detects a malfunction in the Brake Control System (ABS with EBD, Brake Assist, A-TRAC/TRAC and VSC system), the ABS, brake system, VSC/TRAC warning lights and VSC OFF indicator light or TRAC OFF indicator light that corresponds to the function in which the malfunction has been detected indicates or lights up, as indicated in the table below, to alert the driver of the malfunction.

○: Light ON — : Light OFF

Item	ABS	EBD	Brake Assist	A-TRAC/TRAC	VSC	Skid Control ECU
ABS Warning Light	○	○	—	—	—	○
Brake System Warning Light	—	○	○	—	—	○
VSC OFF Indicator Light* ¹	○	○	○	○	○	○
TRAC OFF Indicator Light* ²	○	○	○	○	○	○
VSC/TRAC Warning Light	○	○	○	○	○	○

*¹: Only for 4WD Model

*²: Only for 2WD Model

- At the same time, the DTC (Diagnosis Trouble Codes) are stored in memory. The DTCs can be read by connecting the SST (09843-18040) between the Tc and CG terminals DLC3 and observing the blinking of the ABS warning light, brake system warning light and VSC/TRAC warning light, or by connecting a hand-held tester.
- The following DTC have been added to the Brake Control System (ABS with EBD, BRAKE ASSIST, A-TRAC/TRAC and VSC system):

Output by blinking ABS warning light		Output by blinking VSC/TRAC warning light	
DTC No.	Detection Item	DTC No.	Detection Item
C1244 / 44	Open or short circuit in deceleration sensor circuit	C1207 / 37	Reverse gear signal failure
C1247 / 47	Malfunction in delta S sensor (pedal stroke speed sensor)	C1335 / 35	Malfunction in steering angle sensor communication circuit

2) Fail-Safe

- In the event of a malfunction in the A-TRAC/TRAC and/or VSC, the skid control ECU prohibits the A-TRAC/TRAC and VSC operations.
- In the event of a malfunction in the ABS and/or Brake Assist, the skid control ECU prohibits the ABS with EBD, Brake Assist, A-TRAC/TRAC, and VSC operations.
- In the event of the malfunction in the EBD control, skid control ECU prohibits the EBD control. Thus, the brake and throttle valve opening angle control will be opened in the same condition as in the condition without the ABS with EBD, Brake Assist, A-TRAC/TRAC, VSC.

EA09-006

TOYOTA

2/19/2010

ATTACHMENT 11

11-B



TOYOTA 03-05MY Sequoia

System-FMEA for TRC/VSC

Approval	Approval	Prepare
Oshiro	T.Yoshimi	Chiba
5.mar.2009	9.Mar.09	2009.03.05

Attachment-Response 11-b

CONFIDENTIAL BUSINESS INFORMATION

S-FMEA Project: 532N System: MK25 VSC

CONFIDENTIAL BUSINESS INFORMATION

Attachment-Response 11-b

CONFIDENTIAL BUSINESS INFORMATION

S-FMEA Project: 532N System: MK25 VSC



*1

*2

*1

*2

CONFIDENTIAL BUSINESS INFORMATION

Attachment-Response 11-b

CONFIDENTIAL BUSINESS INFORMATION

S-FMEA Project: 532N System: MK25 VSC

CONFIDENTIAL BUSINESS INFORMATION

Attachment-Response 11-b

CONFIDENTIAL BUSINESS INFORMATION

S-FMEA Project: 532N System: MK25 VSC

CONFIDENTIAL BUSINESS INFORMATION

Attachment-Response 11-b

CONFIDENTIAL BUSINESS INFORMATION

S-FMEA Project: 532N System: MK25 VSC

CONFIDENTIAL BUSINESS INFORMATION

Attachment-Response 11-b

CONFIDENTIAL BUSINESS INFORMATION

S-FMEA Project: 532N System: MK25 VSC

CONFIDENTIAL BUSINESS INFORMATION

Attachment-Response 11-b

CONFIDENTIAL BUSINESS INFORMATION

S-FMEA Project: 532N System: MK25 VSC

CONFIDENTIAL BUSINESS INFORMATION

Attachment-Response 11-b

CONFIDENTIAL BUSINESS INFORMATION

S-FMEA Project: 532N System: MK25 VSC

CONFIDENTIAL BUSINESS INFORMATION

CONFIDENTIAL AND PROPRIETARY.

These documents and their contents are the exclusive property of Continental Teves Corporation. They are not to be copied, distributed, or otherwise disclosed or used without the prior written consent of Continental Teves Corporation. All rights reserved.

EA09-006

TOYOTA

2/19/2010

ATTACHMENT 11

11-C

Driving test data of traction activation (2WD)

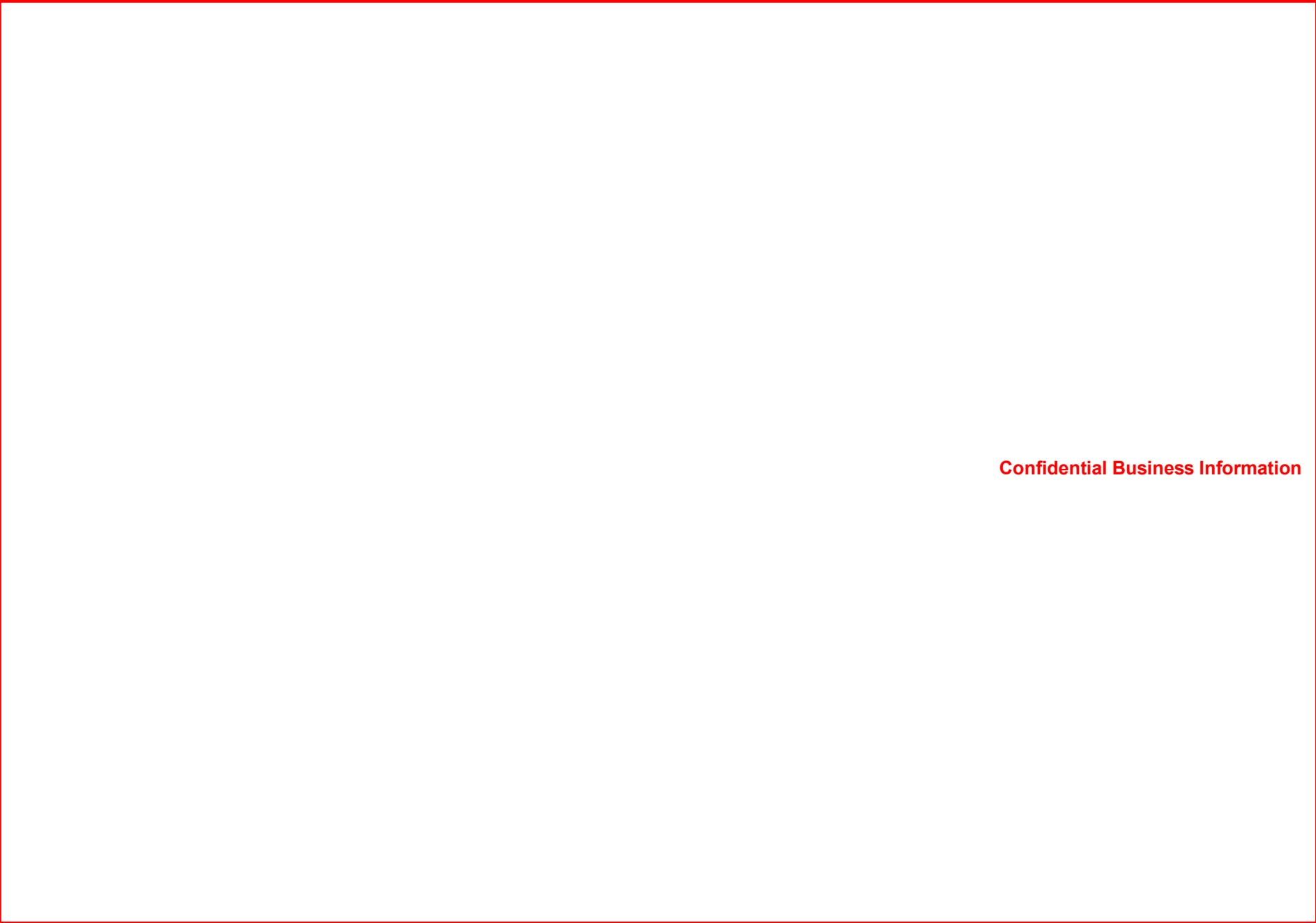

Confidential Business Information

Driving test data of traction activation (2WD)

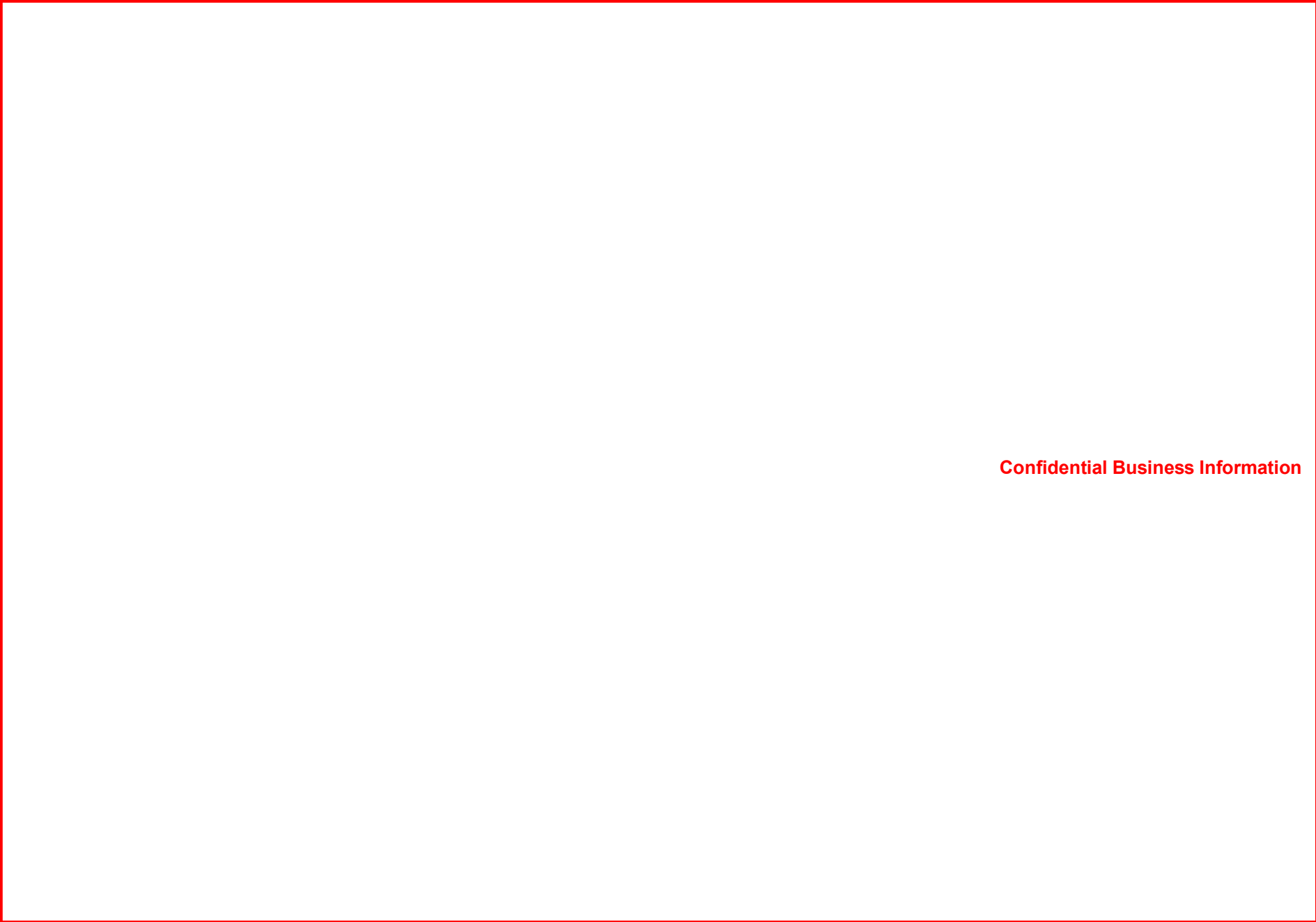

Confidential Business Information

Driving test data of traction activation (4WD)

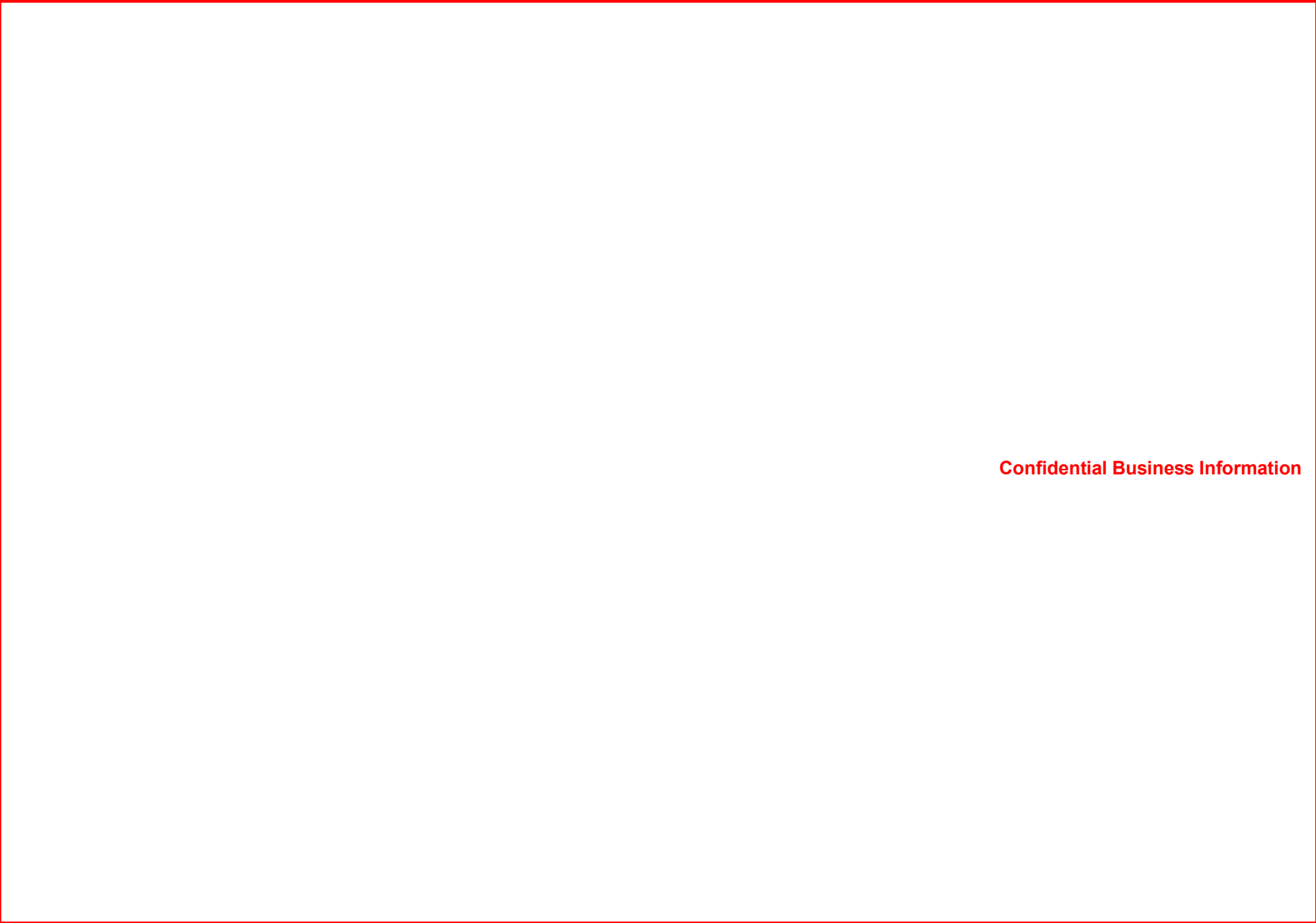

Confidential Business Information

Driving test data of traction activation (4WD)

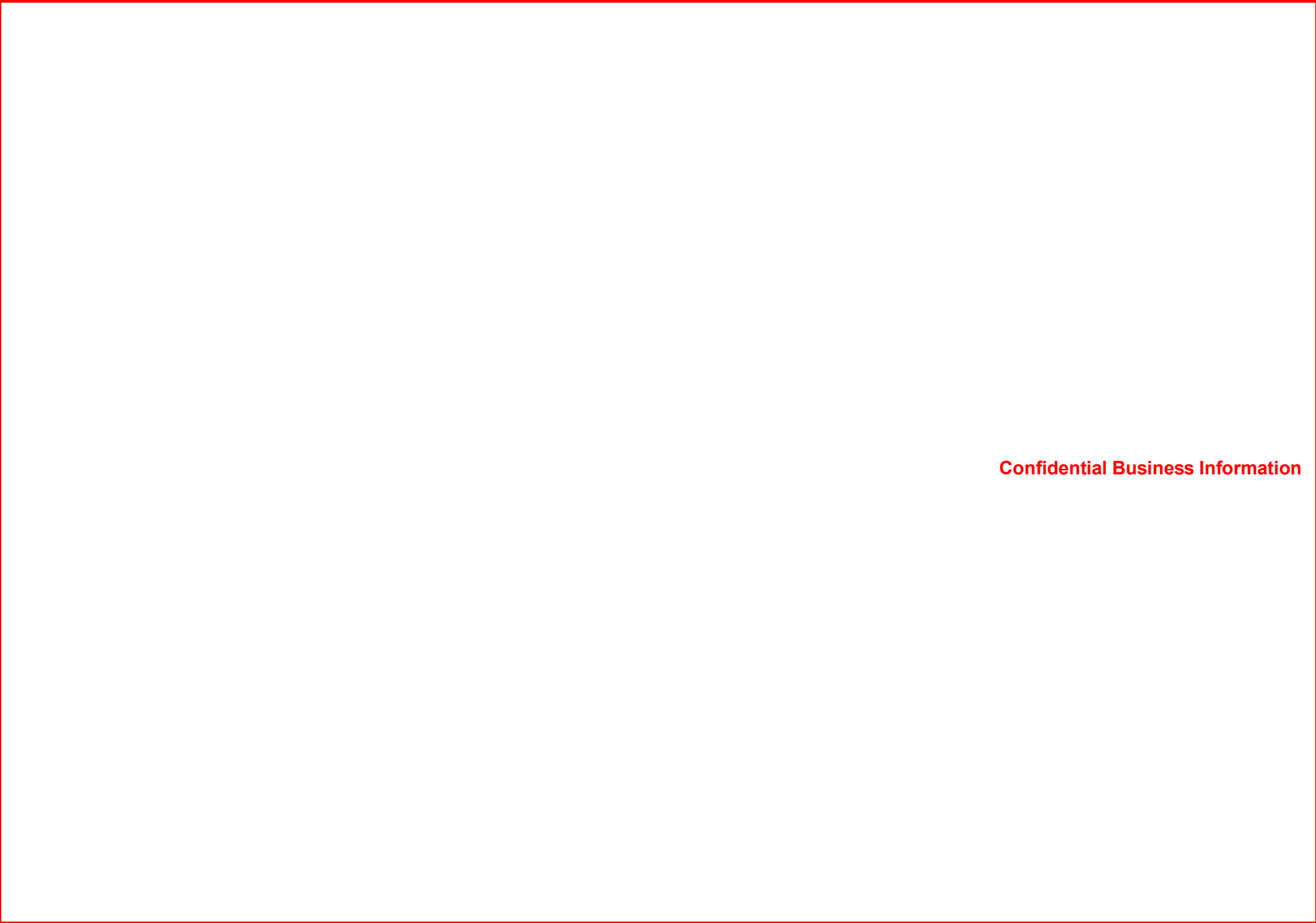

Confidential Business Information

EA09-006

TOYOTA

2/19/2010

ATTACHMENT 11

11-D

Rear Speed Sensor Issue

Vehicle Test Data of worst case

Cornering acceleration with both rear speed sensors slip

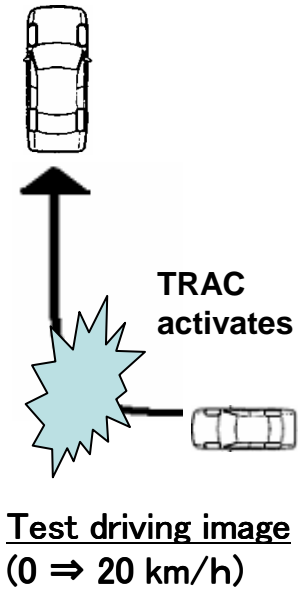
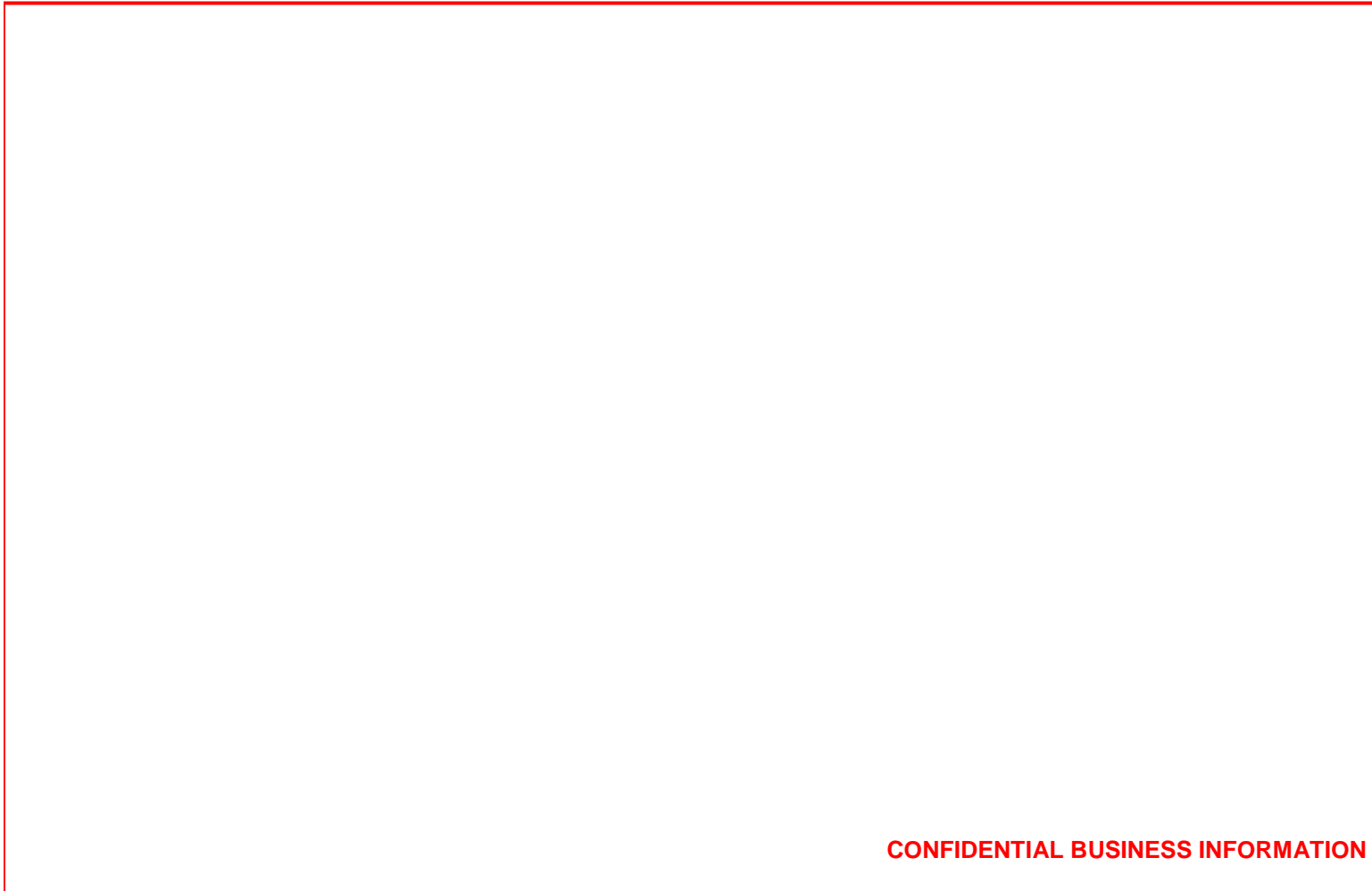

EA09-006

TOYOTA

2/19/2010

ATTACHMENT 11

11-E

SECTION 1-5

OPERATION OF INSTRUMENTS AND CONTROLS

Gauges, Meters and Service reminder indicators

Fuel gauge	130
Engine coolant temperature gauge	130
Oil pressure gauge	131
Voltmeter	132
Tachometer	132
Odometer and two trip meters	132
Service reminder indicators and warning buzzers	134

Fuel gauge

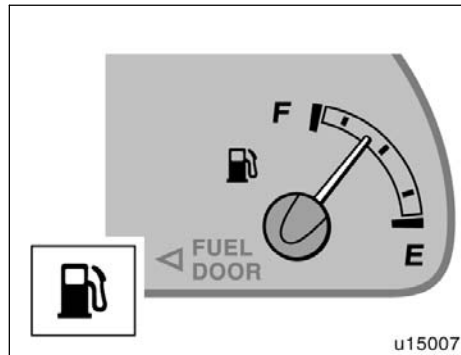

The gauge indicates the approximate quantity of the fuel remaining in the tank when the ignition switch is on.

Nearly full—Needle at “F”

Nearly empty—Needle at “E”

It is a good idea to keep the tank over 1/4 full.

If the fuel level approaches “E” or the low fuel level warning light comes on, fill the fuel tank as soon as possible.

On inclines or curves, due to the movement of fuel in the tank, the fuel gauge needle may fluctuate or the low fuel level warning light may come on earlier than usual.

If the fuel tank is completely empty, the malfunction indicator lamp comes on. Fill the fuel tank immediately.

The indicator lamp goes off after driving several times. If the indicator lamp does not go off, contact your Toyota dealer as soon as possible.

Engine coolant temperature gauge

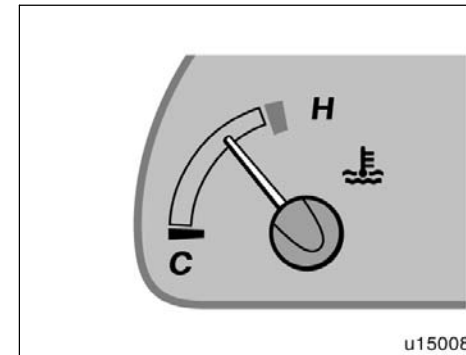

The gauge indicates the engine coolant temperature when the ignition switch is on. The engine operating temperature will vary with changes in weather and engine load.

If the needle moves into the red zone, your engine is too hot. If your vehicle overheats, stop your vehicle and allow the engine to cool.

Your vehicle may overheat during severe operating conditions, such as:

- Driving up a long hill on a hot day.
- Reducing speed or stopping after high speed driving.

- Idling for a long period with the air conditioning on in stop-and-go traffic.
- Towing a trailer.

NOTICE

◆Do not remove the thermostat in the engine cooling system as this may cause the engine to overheat. The thermostat is designed to control the flow of coolant to keep the temperature of the engine within the specified operating range.

◆Do not continue driving with an overheated engine. See “If your vehicle overheats” on page 320 in Section 4.

Oil pressure gauge

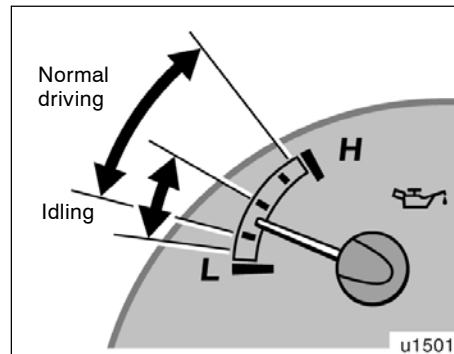

The oil pressure gauge indicates engine oil pressure when the ignition switch is on. Check it while driving to make sure that the needle is in the proper range.

If the oil pressure should stay below the normal range, pull off the road to a safe place and stop the engine immediately. Call a Toyota dealer or qualified repair shop for assistance.

Oil pressure may not build up when the oil level is too low. The oil pressure gauge is not designed to indicate oil level, and the oil level must be checked using the level dipstick.

NOTICE

Do not drive the vehicle with the oil pressure below the normal range until the cause is fixed—it may ruin the engine.

Voltmeter

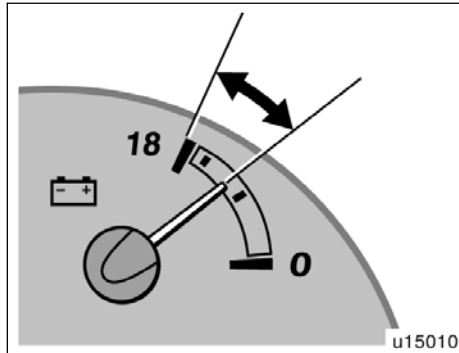

The voltmeter tells whether the battery is charged or discharged. Check it while the engine is running—the needle should always indicate as shown above.

If the needle reads below or above the normal range while the engine is running, it indicates the charging system needs immediate repair.

However, it is normal for the needle to drop below the normal range during engine starting.

Tachometer

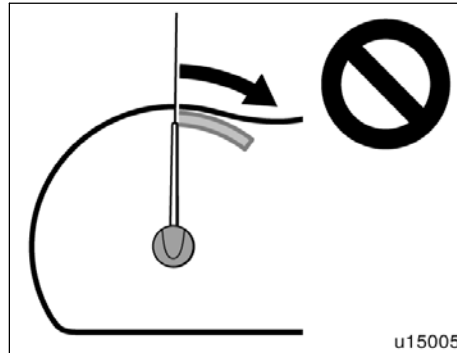

The tachometer indicates engine speed in thousands of rpm (revolutions per minute). Use it while driving to select correct shift points and to prevent engine lugging and over-revving.

Driving with the engine running too fast causes excessive engine wear and poor fuel economy. Remember, in most cases the slower the engine speed, the greater the fuel economy.

NOTICE

Do not let the indicator needle get into the red zone. This may cause severe engine damage.

Odometer and two trip meters

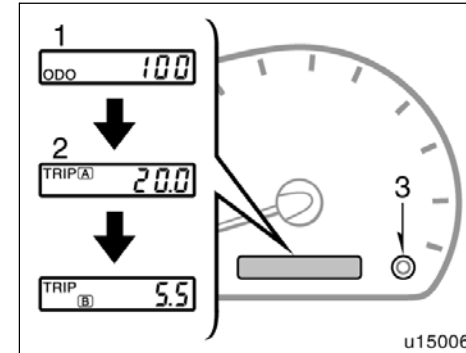

This meter displays the odometer and two trip meters.

1. Odometer—Shows the total distance the vehicle has been driven.
2. Two trip meters—Show two different distances independently driven since the last time each trip meter was set to zero.

You can use one trip meter to calculate the fuel economy and the other to measure the distance on each trip. All trip meter data is cancelled if the electrical power source is disconnected.

3. Trip meter reset knob—Resets the two trip meters to zero, and also change the meter display.







03_SEQUOIA_U (L/O 0301)

To change the meter display, quickly push and release the knob. The meter display changes in the order from the odometer to trip meter A to trip meter B, then back to the odometer each time you push.



To reset the trip meter A to zero, display the meter A reading, then push and hold the knob until the meter is set to zero. The same process can be applied for resetting the trip meter B.

03_SEQUOIA_U (L/O 0301)

Service reminder indicators and warning buzzers

If the indicator or buzzer comes on...		Do this.
(a)	 BRAKE	If parking brake is off, stop immediately and contact Toyota dealer.
(b)	 (indicator and buzzer)	Fasten driver's seat belt.
(c)	PASSENGER 	Fasten front passenger's seat belt.
(d)		Stop and check.
(e)	 CHECK	Take vehicle to Toyota dealer.
(f)		Fill up tank.
(g)	ABS or 	Take vehicle to Toyota dealer. If the brake system warning light is also on, stop immediately and contact Toyota dealer.

03_SEQUOIA_U (L/O 0301)

If the indicator or buzzer comes on...		Do this.
(h)	VSC TRAC	Take vehicle to Toyota dealer.
(i)		Close all doors.
(j)		Take vehicle to Toyota dealer immediately.
(k)	A/T P	Shift front drive control lever out of "N".
(l)	A/T OIL TEMP	Stop and check.
(m)		Add washer fluid.
(n)	Key reminder buzzer	Remove key.

(a) Brake System Warning Light

This light comes on in the following cases when the ignition key is in the "ON" position.

● **When the parking brake is applied...**

This light comes on for a few seconds when the ignition key is turned to the "ON" position even after the parking brake is released.

● **When the brake fluid level is low...**

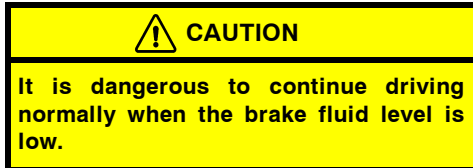

Have your vehicle checked at your Toyota dealer in the following cases:

- The light does not come on even if the parking brake is applied when the ignition key is in the "ON" position.
- The light does not come on even if the ignition key is turned on with the parking brake released.

A warning light turning on briefly during operation does not indicate a problem.

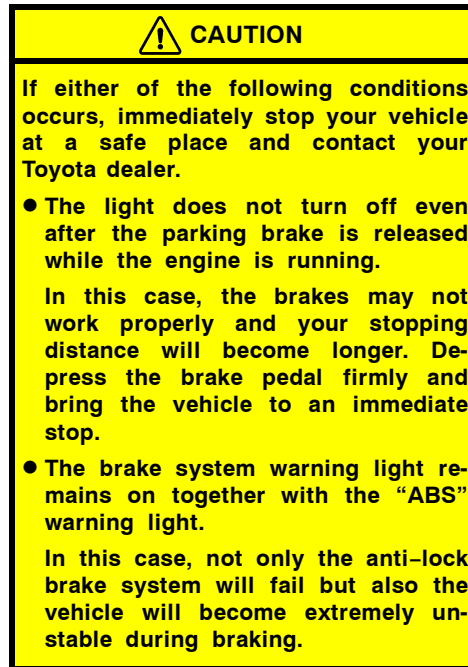

(b) Driver's Seat Belt Reminder Light and Buzzer

This light and buzzer remind you to buckle up the driver's seat belt.

Once the ignition key is turned to "ON" or "START", the reminder light flashes and buzzer come on if the driver's seat belt is not fastened. Unless the driver fastens the belt, the light keeps on flashing and the buzzer sounds for about 4 to 8 seconds.

(c) Front Passenger's Seat Belt Reminder Light

This light reminds you to buckle up the front passenger's seat belt.

Once the ignition key is turned to "ON" or "START", the reminder light flashes if a passenger sits in the front passenger seat and does not fasten the seat belt. However, if a front passenger uses an additional seat cushion, the light may not flash even when the seat belt is not buckled up.

If luggage or other load is placed on the front passenger seat, depending on its weight and how it is placed on the seat, built-in sensors in the seat cushion may detect the pressure, causing the reminder light to come on.

03_SEQUOIA_U (L/O 0301)

(d) Discharge Warning Light

This light warns that the battery is being discharged.

If it comes on while you are driving, there is a problem somewhere in the charging system.

The engine ignition will continue to operate, however, until the battery is discharged. Turn off the air conditioning, blower, radio, etc., and drive directly to the nearest Toyota dealer or repair shop.

NOTICE

Do not continue driving if the engine drive belt is broken or loose.

(e) Malfunction Indicator Lamp

This lamp comes on when the ignition key is turned to the "ON" position and goes off after the engine starts. This means that the warning light system is operating properly.

If the lamp remains on or the lamp comes on while driving, first check the followings.

- Empty fuel tank

If the fuel tank is empty, refuel immediately.

- Loose fuel tank cap

If the fuel tank cap is loose, securely tighten it.

These cases are temporary malfunctions. The malfunction indicator lamp will go off after taking several driving trips.

If the lamp will not go off even after the several trips, contact your Toyota dealer as soon as possible.

If the fuel tank is not empty or the fuel tank cap is not loose...

- There is a problem somewhere in the engine, emission control system, electronic throttle control system, automatic transmission electrical system or warning light system itself.

Contact your Toyota dealer as soon as possible to service the vehicle.

If the engine speed does not increase with the accelerator pedal depressed down, there may be a problem somewhere in your electronic throttle control system.

At this time, vibration may occur. However, if you depress the accelerator pedal more firmly and slowly, you can drive your vehicle at low speeds. Have your vehicle checked by your Toyota dealer as soon as possible.

Even if the abnormality of the electronic throttle control system is corrected during low speed driving, the system may not be recovered until the engine is stopped and the ignition key is turned to "ACC" or "LOCK" position.

CAUTION

Be especially careful to prevent erroneous pedal operation.

Emissions inspection and maintenance (I/M) programs

We recommend you to contact your Toyota dealer to check your vehicle's emission control system and OBD (On-Board Diagnostics) system before taking your vehicle for a state emission inspection.

For details, see "Emissions Inspection and Maintenance (I/M) programs" on page 350 in Section 6.

(f) Low Fuel Level Warning Light

This light comes on when the fuel level in the tank becomes nearly empty. Fill up the tank as soon as possible.

On inclines or curves, due to the movement of fuel in the tank, the low fuel level warning light may come on earlier than usual.

(g) "ABS" Warning Light

The light comes on when the ignition key is turned to the "ON" position. If the anti-lock brake system and the brake assist system work properly, the light turns off after a few seconds. Thereafter, if either of the systems malfunctions, the light comes on again.

When the "ABS" warning light is on (and the brake system warning light is off), the anti-lock brake system, the brake assist system, the traction control system (two-wheel drive vehicles), the active traction control system (four-wheel drive vehicles) and the vehicle skid control system do not operate, but the brake system still operates conventionally.

When the "ABS" warning light is on (and the brake system warning light is off), the anti-lock brake system does not operate so that the wheels could lock up during a sudden braking or braking on slippery road surfaces.

If either of the following conditions occurs, this indicates a malfunction somewhere in the parts monitored by the warning light system. Contact your Toyota dealer as soon as possible to service the vehicle.

- The light does not come on when the ignition key is turned to the "ON" position, or remains on.
- The light comes on while you are driving.

A warning light turning on briefly during operation does not indicate a problem.

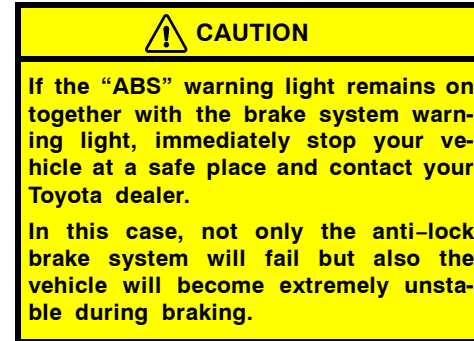

(h) "VSC/TRAC" Warning Light

This light warns that there is a problem somewhere in the vehicle skid control system and traction control system (two-wheel drive models) or active traction control system (four-wheel drive models).

The light will come on when the ignition key is turned to "ON" and will go off after a few seconds.

If the light comes on while driving, the system does not work. However, as conventional braking operates when applied, there is no problem to continue your driving.

03_SEQUOIA_U (L/O 0301)

In the following cases, contact your Toyota dealer:

- The warning light does not come on after the ignition key is turned to “ON”.
- The warning light remains on after the ignition key is turned to “ON”.
- The warning light comes on while driving.

(i) Open Door Warning Light

This light remains on until all the side doors and back door are completely closed.

(j) SRS Warning Light

This light will come on when the ignition key is turned to the “ON” position. After about 6 seconds, the light will go off. This means the system of the airbag and front seat belt pretensioner are operating properly.

The warning light system monitors the airbag sensor assembly, front airbag sensors, side and curtain shield airbag sensors, front seat belt pretensioner assemblies, inflators, warning light, interconnecting wiring and power sources.

If either of the following conditions occurs, this indicates a malfunction somewhere in the parts monitored by the warning light system. Contact your Toyota dealer as soon as possible to service the vehicle.

- The light does not come on when the ignition key is turned to the “ON” position or remains on.
- The light comes on or flashes while driving.

(k) Unengaged “Park” Warning Light

This light warns that the transmission “Park” mechanism is not engaged. If the front drive control lever is in the “N” position while the selector lever is in the “P” position, the transmission will disengage and the wheels will not lock.



To restore the park function, shift the front drive control lever out of “N”, or the vehicle can move.

(l) Automatic Transmission Fluid Temperature Warning Light

This light warns that the automatic transmission fluid temperature is too high.

If this light comes on while you are driving, slow down and pull off the road. Stop the vehicle at a safe place and put the selector lever in “P”. With the engine idling, wait until the light goes off. If the light goes off, you may start the vehicle again. If the light does not go off, call a Toyota dealer or qualified repair shop for assistance.

NOTICE

Continued driving with the warning light on may damage the automatic transmission.

(m) Low Windshield Washer Fluid Level Warning Light

This light warns that the windshield washer fluid level is too low. Add washer fluid at your earliest opportunity. (For instructions, see “Adding washer fluid” on page 375 in Section 7-3.)

03_SEQUOIA_U (L/O 0301)

(n) Key Reminder Buzzer

This buzzer reminds you to remove the key when you open the driver's door with the ignition key in the "ACC" or "LOCK" position.

CHECKING SERVICE REMINDER INDICATORS (except the low fuel level warning light and low windshield washer fluid level warning light)

1. Apply the parking brake.
2. Open one of the side doors or back door.
The open door warning light should come on.
3. Close the door.
The open door warning light should go off.
4. Turn the ignition key to "ON", but do not start the engine.
All the service reminder indicators except the open door warning light should come on. The "ABS" and "VSC/TRAC" warning lights, "TRAC OFF" (two-wheel drive models) or "VSC OFF" (four-wheel drive models) indicator light and slip indicator light go off after a few seconds. The SRS warning light goes off after about 6 seconds.
5. Place the front drive control lever in "N" position and the selector lever in "P" position.
The unengaged "Park" warning light should come on.

6. Shift the front drive control lever out of "N".
The unengaged "Park" warning light should go off.

If any service reminder indicator or warning buzzer does not function as described above, have it checked by your Toyota dealer as soon as possible.

SECTION 1-6

OPERATION OF INSTRUMENTS AND CONTROLS

Ignition switch, Transmission and Parking brake

Ignition switch with steering lock	142
Automatic transmission	143
Four-wheel drive system	147
Traction control system	151
Active traction control system	154
Vehicle skid control system	156
Parking brake	158
Cruise control	159

Ignition switch with steering lock

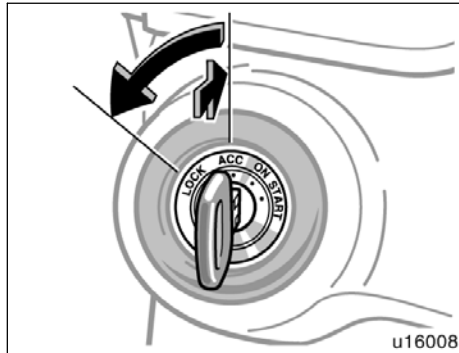

“START”—Starter motor on. The key will return to the “ON” position when released.

For starting tips, see page 298 in Section 3.

“ON”—Engine on and all accessories on.

This is the normal driving position.

“ACC”—Accessories such as the radio operate, but the engine is off.

If you leave the key in the “ACC” or “LOCK” position and open the driver’s door, a buzzer will remind you to remove the key.

“LOCK”—Engine is off and the steering wheel is locked. The key can be removed only at this position.

You must push in the key to turn it from “ACC” to the “LOCK” position. The selector lever must be in the “P” position before pushing the key.

Once you remove the key, the engine immobiliser system is automatically set. (See “Engine immobiliser system” on page 12 in Section 1-2.)

When starting the engine, the key may seem stuck at the “LOCK” position. To free it, first be sure the key is pushed all the way in, and then rock the steering wheel slightly while turning the key gently.

NOTICE

Do not leave the key in the “ON” position if the engine is not running. The battery will discharge and the ignition could be damaged.

Automatic transmission

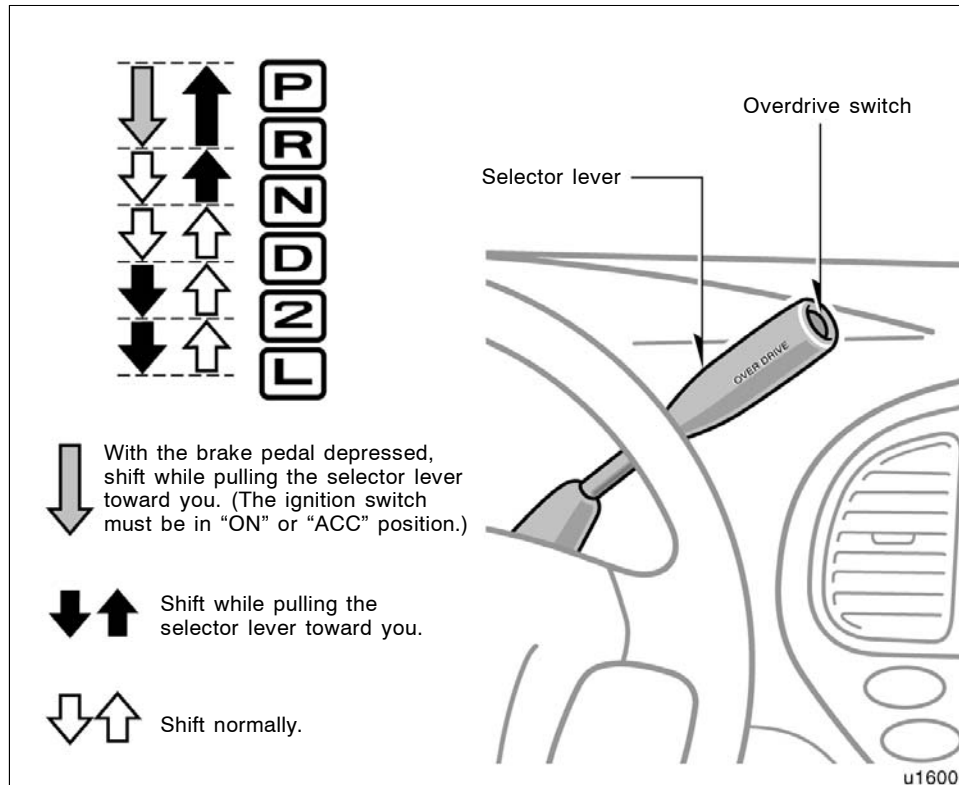

Your automatic transmission has a shift lock system to minimize the possibility of incorrect operation. This means you can only shift out of "P" position when the brake pedal is depressed (with the ignition switch in "ON" or "ACC" position and the selector lever pulled toward you).

(a) Selector lever

The shift position is displayed on the instrument cluster.

P: Parking, engine starting and key removal

R: Reverse

N: Neutral

D: Normal driving (with overdrive on)

2: Stronger engine braking

L: Maximum engine braking

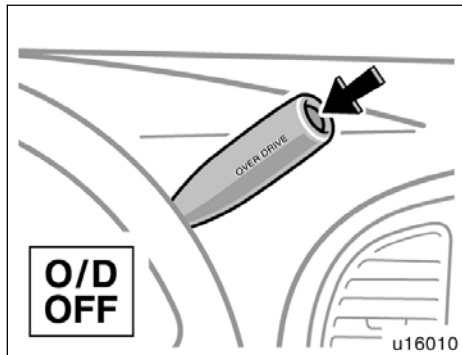

(b) Overdrive switch

You can select either third gear (with overdrive off) or fourth gear (with overdrive on) by pushing this switch.

To turn the overdrive off, push the switch. The "O/D OFF" indicator light should come on. To turn the overdrive on again, push the switch again. The "O/D OFF" indicator light should go off.

Always drive your vehicle with the overdrive on for better fuel economy and quieter driving.

If the engine is turned off when the overdrive is off and restarted, the overdrive will be on automatically.

When the cruise control is being used, even if you downshift the transmission by pushing and releasing the overdrive switch, engine braking will not be enabled because the cruise control is not cancelled.

For ways to decrease the vehicle speed, see "Cruise control" on page 159 in this section.

(c) Normal driving

1. Start the engine as instructed in "How to start the engine" on page 298 in Section 3. The transmission must be in "P" or "N".

When the front drive control lever is in "L4" (low-speed position, four-wheel drive), the driving pattern selector setting has no effect on gear shift timing. (See "Four-wheel drive system" on page 147 in this section for information of the front drive control lever.)

2. With your foot holding down the brake pedal, shift the selector lever to "D".

When the lever is in the "D" position, the automatic transmission system will select the most suitable gear for running conditions such as normal cruising, hill climbing, hard towing, etc.

Always turn the overdrive on for better fuel economy and quieter driving. If the engine coolant temperature is low or when the front drive control lever is in "L4" (low-speed position, four-wheel drive), the transmission will not shift into the overdrive gear even with the overdrive on. (See "Four-wheel drive system" on page 147 in this section for information of the front drive control lever.)

<p>Never put your foot on the accelerator pedal while shifting.</p>

3. Release the parking brake and brake pedal. Depress the accelerator pedal slowly for smooth starting.

If the automatic locking operation linked to shift lever position is set, all doors are automatically locked when the shift lever is moved out of "P" position after the ignition switch is turned to the "ON" position and all the doors are closed. For details, see "—Automatic door locking and unlocking functions" on page 16 in Section 1-2.

03_SEQUOIA_U (L/O 0301)

(d) Using engine braking

To use engine braking, you can downshift the transmission as follows:

- Push the overdrive switch. The “O/D OFF” indicator light will come on and the transmission will downshift to third gear.
- Shift into the “2” position. The transmission will downshift to second gear when the vehicle speed drops down to or lower than the following speed, and stronger engine braking will be enabled.

Two-wheel drive models
110 km/h (68 mph)

Four-wheel drive models
Front drive control lever in “H” (2WD) or “H” (4WD)
110 km/h (68 mph)

Front drive control lever in “L4”
39 km/h (24 mph)

- Shift into the “L” position. The transmission will downshift to first gear when the vehicle speed drops down to or lower than the following speed, and maximum engine braking will be enabled.

Two-wheel drive models
55 km/h (34 mph)

Four-wheel drive models
Front drive control lever in “H” (2WD) or “H” (4WD)
55 km/h (34 mph)

Front drive control lever in “L4”
10 km/h (5 mph)

When the cruise control is being used, even if you downshift the transmission by pushing and releasing the overdrive switch, engine braking will not be enabled because the cruise control is not cancelled.

For ways to decrease the vehicle speed, see “Cruise control” on page 159 in this section.



Be careful when downshifting on a slippery surface. Abrupt shifting could cause the vehicle to spin or skid.

(e) Using the “2” and “L”, positions

The “2” and “L” positions are used for strong engine braking as described previously.

With the selector lever in “2” or “L”, you can start the vehicle in motion as with the lever in “D”.

With the selector lever in “2”, the vehicle will start in first gear and automatically shift to second gear.

With the selector lever in “L”, the transmission is engaged in first gear.

NOTICE

◆ **Be careful not to over-rev the engine. Watch the tachometer to keep engine rpm from going into the red zone. The approximate maximum allowable speed for each position is given above for your reference:**

Two-wheel drive models
 "2" 110 km/h (68 mph)
 "L" 60 km/h (38 mph)

Four-wheel drive models

Front drive control lever in "H" (2WD) or "H" (4WD)
 "2" 110 km/h (68 mph)
 "L" 60 km/h (38 mph)

Front drive control lever in "L4"
 "2" 45 km/h (28 mph)
 "L" 25 km/h (16 mph)

◆ **Do not continue hill climbing or hard towing for a long time in the "2" or "L" position. This may cause severe automatic transmission damage from overheating. To prevent such damage, "D" position should be used in hill climbing or hard towing.**

(f) Backing up

1. Bring the vehicle to a complete stop.
2. With the brake pedal held down with your foot, shift the selector lever to the "R" position.

NOTICE

Never shift into reverse while the vehicle is moving.

(g) Parking

1. Bring the vehicle to a complete stop.
2. With the brake pedal pressed down, fully depress the parking brake pedal to apply the parking brake securely.
3. With the brake pedal pressed down, shift the selector lever to the "P" position.

 **CAUTION**

Never attempt to move the selector lever into "P" position under any circumstances while the vehicle is moving. Serious mechanical damage and loss of vehicle control may result.

If the automatic unlocking operation linked to shift lever position is set, all doors are automatically unlocked when the selector lever is moved to "P" position after the ignition switch is turned to "ON" position. For details, see "—Automatic door locking and unlocking functions" on page 16 in Section 1-2.

(h) Good driving practice

- If the transmission repeatedly shifts up and down between third gear and overdrive when climbing a gentle slope, the overdrive should be turned off. Be sure to turn the switch on immediately afterward.
- When towing a trailer, in order to maintain engine braking efficiency, do not use overdrive.

 **CAUTION**

Always keep your foot on the brake pedal while stopped with the engine running. This prevents the vehicle from creeping.

**Four-wheel drive system—
(a) Front drive control**

NOTICE

Always use the brake pedal or the parking brake to hold the vehicle on an upgrade. Do not attempt to hold the vehicle using the accelerator pedal, as this can cause the transmission to overheat.

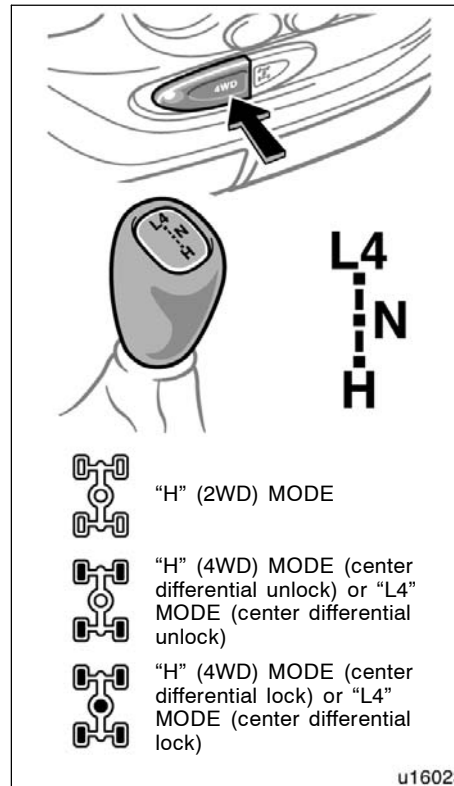

Use the front drive control lever, “4WD” switch and center differential lock switch to select the transfer and center differential modes.

The “H” and “L4” position of the front drive control lever provide either lock or unlock the mode of the center differential.

Use the center differential lock system if your wheels get stuck in a ditch, or when you are driving on a slippery or bumpy surface. When the center differential is locked, the vehicle skid control system is automatically turned off and the center differential lock and “VSC OFF” indicator lights come on because the function that controls engine performance interferes with the process of freeing your wheels.

NOTICE

As soon as the center differential lock switch is turned on, the “VSC OFF” indicator light comes on. After the wheels are out of the ditch or off the slippery or bumpy surface, turn the center differential lock switch off. Make sure that the center differential lock indicator light and “VSC OFF” indicator light turn off.

03_SEQUOIA_U (L/O 0301)

“H” mode (high speed position, two-wheel drive): Front drive control lever at “H”, “4WD” switch left out

Use this for normal driving on dry hard-surfaced roads. This position gives greater economy, quietest ride and least wear and better vehicle control.

“H” mode (high speed position, four-wheel drive, center differential unlocked): Front drive control lever at “H”, “4WD” switch pushed once, center differential lock switch left out

Use this for normal driving on all types of roads, from dry hard-surfaced roads to wet, icy or snow-covered roads. This position provides greater traction than two-wheel drive.

“H” mode (high speed position, four-wheel drive, center differential locked): Front drive control lever at “H”, “4WD” button pushed once center differential lock switch pushed once

Use this for greater traction when you experience a loss of power, such as wheel slipping, in the center differential unlock mode.

“N” mode (neutral position): Front drive control lever at “N”

No power is delivered to the wheels. The vehicle must be stopped.

“L4” mode (low speed position, four-wheel drive, center differential unlocked): Front drive control lever at “L4”, center differential lock switch left out

Use this for maximum power and traction. Use this for climbing steep hills, off-road driving, and hard pulling in sand or mud.

In this mode, the braking feeling that occurs when the wheels are negotiating a sharp corner is further reduced than in the “L4” (low position, four-wheel drive, center differential locked) mode.

If you place the transmission shift lever at “2” in this mode, the transmission automatically shifts up from second gear. This system is effective when starting your vehicle in sand, mud, ice or snow. (However, the transmission system may shift up from first gear when the vehicle starts too quickly.)

“L4” mode (low speed position, four-wheel drive, center differential locked):

Front drive control lever at “L4”, center differential lock switch pushed once
Use this for maximum power and traction. Use this for hard pulling in situations the vehicle cannot negotiate even in the “L4” (low speed position, four-wheel drive, center differential unlocked) mode. Also, using this mode when driving down steep off-road inclines will help contribute to increased vehicle stability.

The indicator shows which transfer and center differential mode the vehicle is in.

When the shifting operation has not been completed after moving the lever, the indicator flashes. If the indicator light does not go off when you push out the center differential lock switch, drive straight ahead while accelerating or decelerating, or drive in reverse. If the indicator flashes even if doing so, contact your Toyota dealer as soon as possible. There may be a trouble in the four wheel drive system.

See “(c) Shifting procedure” for further instructions.

03_SEQUOIA_U (L/O 0301)

Advice for driving on slippery roads in “L4” (low speed position) mode

If you shift the front drive control lever to “L4” and the automatic transmission lever to “2” when you drive in steep off-road areas, the output of the brake can be controlled effectively by the active traction control system, which assists the driver to control the driving power of 4 wheels.

Use the “L” position of the automatic transmission lever for maximum power and traction when your wheels get stuck or when you drive down a steep incline. In the following cases, the output of the brake can be controlled by the active traction control system if the engine speed is under 3000 rpm (normally engine speed is under 3000 rpm when the wheels get unstuck).

- The front drive control lever in the “L4” position and the automatic transmission lever in the “L” position or the automatic transmission lever in the “D” or “2” with the transmission downshifting to the first gear
- The front drive control lever in the “L4” position and the automatic transmission lever in the “R” position

(As for the automatic transmission lever positions, see “Automatic transmission” in this section.)

(b) A.D.D. (automatic disconnecting differential)

The A.D.D. can be engaged or disengaged by the shifting operations described in “(c) Shifting procedure”.

You should drive in four-wheel drive for at least 16 km (10 miles) each month. This will assure that the front drive components are lubricated.

(c) Shifting procedure

SHIFTING BETWEEN “H” (2WD) MODE AND “H” (4WD) MODE

To shift from “H” (2WD) mode to “H” (4WD) mode, reduce your speed to less than 100 km/h (62 mph) and push in the “4WD” switch.

If the indicator light flashes when you push in the “4WD” switch, drive straight ahead while accelerating or decelerating.

If the indicator light flashes and the buzzer sounds when you push in the “4WD” switch, reduce your speed or stop the vehicle and reset.

 CAUTION
<p>Never push the “4WD” switch if wheels are slipping. Stop the slipping or spinning before shifting.</p>

To shift from “H” (4WD) mode to “H” (2WD) mode, push the “4WD” switch again to turn it off.

This can be done at any vehicle speed.

If the indicator light flashes when you push in the “4WD” switch, drive straight ahead while accelerating or decelerating, or drive in reverse.

SHIFTING BETWEEN “H” (4WD, UNLOCKED) AND “H” (4WD, LOCKED)

To shift from “H” (4WD, UNLOCKED) to “H” (4WD, LOCKED), push in the center differential lock switch.

If the indicator light flashes when you push in the center differential lock switch, drive straight ahead while accelerating or decelerating.

If the indicator light flashes and the buzzer sounds when you push in the center differential lock switch, reduce your speed or stop the vehicle and reset.

 CAUTION
<p>Never push the center differential lock switch if wheels are slipping. Stop the slipping or spinning before shifting.</p>

NOTICE
<p><i>Do not drive on a dry paved surface in “H” (4WD, LOCKED) mode. This may damage the locking mechanism and the drive system.</i></p>

To shift from “H” (4WD, LOCKED) to “H” (4WD, UNLOCKED), left out the center differential lock switch.

This can be done at any vehicle speed.

If the indicator light flashes when you left out the center differential lock switch, drive straight ahead while accelerating or decelerating, or drive in reverse.

SHIFTING BETWEEN “H” AND “L4”

If the front drive control lever is shifted from “L4” to “H”, the mode will be “H” (4WD).

Stop the vehicle and put the transmission in “N”. With your foot holding down the brake pedal, move the front drive control lever.

If the indicator light flashes when you move the front drive control lever, drive straight ahead while accelerating or decelerating.

 CAUTION
<p>Never move the front drive control lever if wheels are slipping. Stop the slipping or spinning before shifting.</p>

NOTICE

Do not drive on a dry paved surface in "L4" (LOCKED) mode. This may damage the locking mechanism and the drive system.

SHIFTING BETWEEN "L4" (UNLOCKED) AND "L4" (LOCKED)

To shift between unlock and lock modes in "L", push the center differential lock switch.

This can be done at any vehicle speed.

If the indicator light flashes when you push the center differential lock switch, drive straight ahead while accelerating or decelerating.

 **CAUTION**

Never push the center differential lock switch if wheels are slipping. Stop the slipping or spinning before shifting.

NOTICE

Do not drive on a dry paved surface in "L4" (LOCKED) mode. This may damage the locking mechanism and the drive system.

**Traction control system
(two-wheel drive models)**

The traction control system automatically helps prevent the spinning of rear wheels when the vehicle is started or accelerated on slippery road surfaces.

When the ignition key is turned to "ON", the system automatically turns on.

 **CAUTION**

Under certain slippery road conditions, full traction of the vehicle and power against rear wheels cannot be maintained, even though the traction control system is in operation. Do not drive the vehicle under any speed or maneuvering conditions which may cause the vehicle to lose traction control. In situations where the road surface is covered with ice or snow, your vehicle should be fitted with snow tires or tire chains. Always drive at an appropriate and cautious speed for the present road conditions.

03_SEQUOIA_U (L/O 0301)

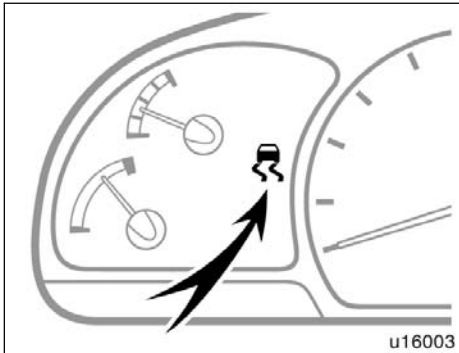

NORMAL DRIVING MODE

Leave the system on during the ordinary driving so that it can operate when needed.

You may hear a sound in the engine compartment for a few seconds when the engine is started or just after the vehicle begins to move. This means that the traction control system is in the self-check mode, but does not indicate a malfunction.

When the traction control system is operating, the following conditions occur:

- The system controls the spinning of the rear wheels. At this time, the slip indicator light blinks.
- You may feel vibration or noise in your vehicle, caused by operation of the brakes. This indicates the system is functioning properly.

The slip indicator light comes on for a few seconds when the ignition key is turned to "ON". If the indicator light does not come on when the ignition is turned on, contact your Toyota dealer.

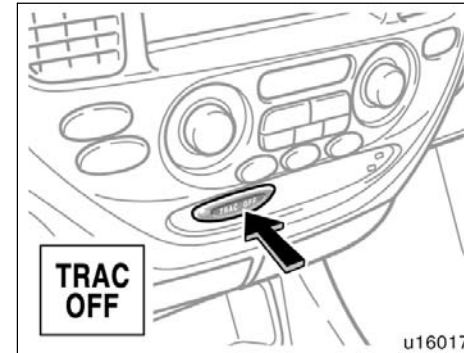

TRACTION CONTROL OFF MODE

If your wheels get stuck in a ditch when you are driving on a severe off road and sand, turn off the traction control system. This system that controls engine performance interferes with the process of freeing your wheels.

To turn off: Push "TRAC OFF" switch.

The "TRAC OFF" indicator light will come on.

To turn on: Push "TRAC OFF" switch once again.

The "TRAC OFF" indicator light will go off.

03_SEQUOIA_U (L/O 0301)

The traction control system will automatically go on, and the "TRAC OFF" indicator light will go off when you drive over 30 km/h (19 mph) even if the "TRAC OFF" switch is pushed to cancel the traction control system.

"TRAC OFF" indicator light comes on for a few seconds when the ignition key is turned to "ON". It will come on again when you push the "TRAC OFF" switch to turn off the system.

In the following cases, contact your Toyota dealer:

- The indicator light does not come on when the ignition key is turned "ON".
- The indicator light remains on after the ignition is turned on.
- The indicator light comes on with the normal driving mode while driving.

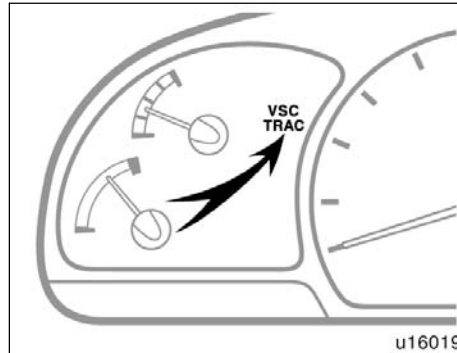

"VSC/TRAC" warning light

This light warns that there is a problem somewhere in the traction control system or the vehicle skid control system.

The warning light will come on when the ignition key is turned to "ON" and will go off after a few seconds.

The brake pad or actuator temperature increases during continuous operation of the traction control system or vehicle skid control system such as on slippery roads. If the brake pad or actuator temperature becomes too high while the traction control system or vehicle skid control system is operating, a buzzer will start to sound intermittently to indicate that the traction control system can no longer operate. In this case, stop your vehicle immediately at a safe place.

If the system continues to operate, the buzzer sound changes from intermittent to continuous. (The continuous buzzer sounds for about 3 seconds.)

At the time the "VSC/TRAC" warning light will come on and the traction control system temporarily stops operating in order to protect the brake pad. (Although the traction control system does not operate, there is no problem to continue your driving.) The system will be automatically restored after a short time and the warning light goes out.

If the light comes on while driving, the traction control system does not work. However, as conventional braking operates when applied, there is no problem to continue your driving.

Active traction control system

(four-wheel drive models)

In the following cases, contact your Toyota dealer:

- The warning light does not come on after the ignition key is turned to "ON".
- The warning light remains on after the ignition key is turned to "ON".
- The warning light comes on while driving.

The active traction control system automatically helps prevent the spinning of 4 wheels (4WD mode) or rear wheels (2WD mode) when the vehicle is started or accelerated on slippery road surfaces.

When the ignition key is turned to "ON", the system automatically turns on.

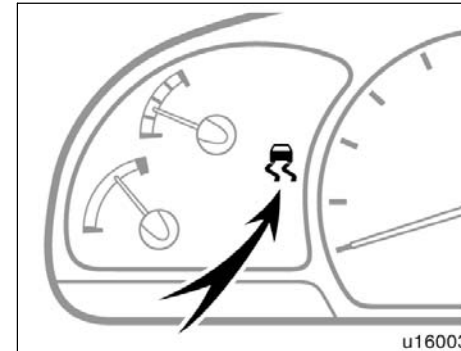

CAUTION

Under certain slippery road conditions, full traction of the vehicle and power against 4 wheels (4WD mode) or rear wheels (2WD mode) cannot be maintained, even though the active traction control system is in operation. Do not drive the vehicle under any speed or maneuvering conditions which may cause the vehicle to lose traction control. In situations where the road surface is covered with ice or snow, your vehicle should be fitted with snow tires or tire chains. Always drive at an appropriate and cautious speed for the present road conditions.

Leave the system on during the ordinary driving so that it can operate when needed.

You may hear a sound in the engine compartment for a few seconds when the engine is started or just after the vehicle begins to move. This means that the active traction control system is in the self-check mode, but does not indicate a malfunction.

03_SEQUOIA_U (L/O 0301)

When the traction control system is operating, the following conditions occur:

- The system controls the spinning of the 4 wheels (4WD mode) or rear wheels (2WD mode). At this time, the slip indicator light blinks.
- You may feel vibration or noise in your vehicle, caused by operation of the brakes. This indicates the system is functioning properly.

The slip indicator light comes on for a few seconds when the ignition key is turned to "ON". If the indicator light does not come on when the ignition is turned on, contact your Toyota dealer.

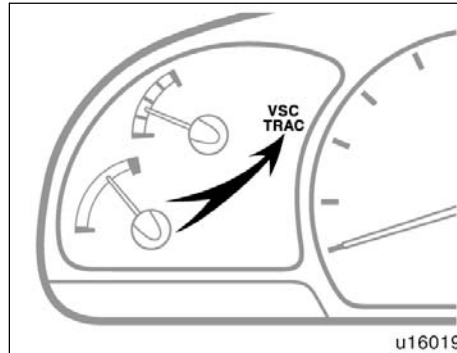

"VSC/TRAC" warning light

This light warns that there is a problem somewhere in the active traction control system or the vehicle skid control system.

The warning light will come on when the ignition key is turned to "ON" and will go off after a few seconds.

The brake pad or actuator temperature increases during continuous operation of the active traction control system or vehicle skid control system such as on slippery roads. If the brake pad or actuator temperature becomes too high while the active traction control system or vehicle skid control system is operating, a buzzer will start to sound intermittently to indicate that the active traction control system can no longer operate. In this case, stop your vehicle immediately at a safe place.

If the system continues to operate, the buzzer sound changes from intermittent to continuous. (The continuous buzzer sounds for about 3 seconds.)

At the time, the "VSC/TRAC" warning light will come on and the active traction control system temporarily stops operating in order to protect the brake pad. (Although the active traction control system does not operate, there is no problem to continue your driving.) The system will be automatically restored after a short time and the warning light goes out.

If the light comes on while driving, the active traction control system does not work. However, as conventional braking operates when applied, there is no problem to continue your driving.

In the following cases, contact your Toyota dealer:

- The warning light does not come on after the ignition key is turned to "ON".
- The warning light remains on after the ignition key is turned to "ON".
- The warning light comes on while driving.

Vehicle skid control system

The vehicle skid control system helps provide integrated control of the systems such as anti-lock brake system, traction control, engine control, etc. This system automatically controls the brakes and engine to help prevent the vehicle from skidding when cornering on a slippery road surface or operating steering wheel abruptly.

The vehicle skid control activates when the vehicle speed is more than the following speed.

- Front drive control lever in "H"
15 km/h (9 mph)
- Front drive control lever in "L4"
30 km/h (18 mph)

You may hear a sound in the engine compartment for a few seconds when the engine is started or just after the vehicle begins to move. This means that the system is in the self-check mode but does not indicate a malfunction.

CAUTION

- **Do not rely excessively on the vehicle skid control system. Even if the vehicle skid control system is operating, you must always drive carefully and attentively to avoid serious injury. Reckless driving will result in an unexpected accident. If the slip indicator light blinks, sounding an alarm sounds, special care should be taken while driving.**
- **Only use tires of specified size. The size, manufacturer, brand and tread pattern for all 4 tires should be the same. If you use the tires other than specified, or different type or size, the vehicle skid control system may not function correctly. When replacing the tires or wheels, contact your Toyota dealer. (See "Checking and replacing tires" on page 364 in Section 7-2.)**

03_SEQUOIA_U (L/O 0301)

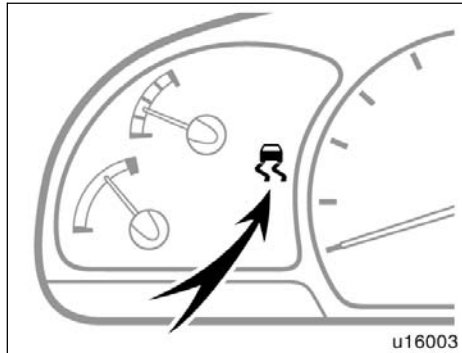

If the vehicle is going to skid during driving, the slip indicator light blinks and an alarm sounds intermittently. Special care should be taken while driving.

The slip indicator light comes on for a few seconds when the ignition key is turned to "ON". If the indicator light does not come on when the ignition is turned on, contact your Toyota dealer.

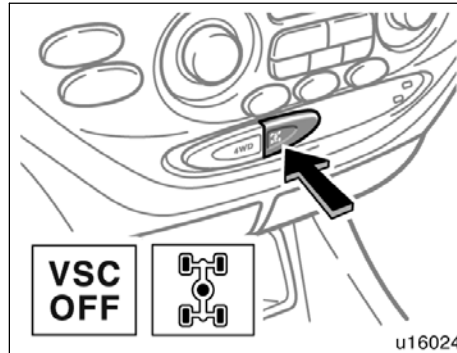

Four-wheel drive models only—

Pushing the center differential lock switch automatically turns the vehicle skid control system off. At this time, the "VSC OFF" indicator comes on with the center differential lock indicator light.

"VSC OFF" indicator light comes on for a few seconds when the ignition key is turned to "ON".

In the following cases, contact your Toyota dealer:

- The indicator light does not come on when the ignition key is turned "ON".
- The indicator light remains on after the ignition is turned on.
- The indicator light comes on when the system is on while driving.

NOTICE

Make sure that the center differential lock indicator light goes off before normal driving.

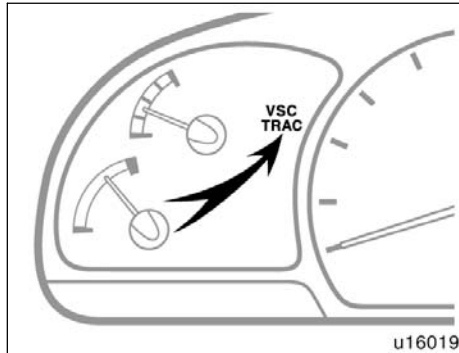

“VSC/TRAC” warning light

This light warns that there is a problem somewhere in the vehicle skid control system, traction control system (two-wheel drive models) or active traction control system (four-wheel drive models).

The warning light will come on when the ignition key is turned to “ON” and will go off after a few seconds.

If the light comes on while driving, the system does not work. However, as conventional braking operates when applied, there is no problem to continue your driving.

In the following cases, contact your Toyota dealer:

- The warning light does not come on after the ignition key is turned to “ON”.
- The warning light remains on after the ignition key is turned to “ON”.
- The warning light comes on while driving.

Parking brake

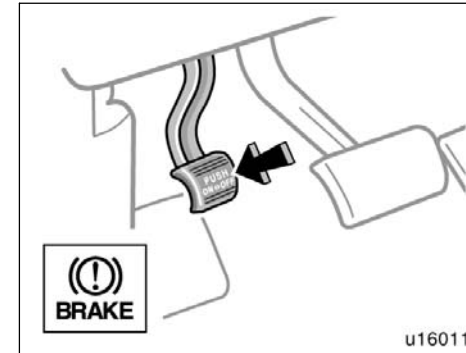

When parking, firmly apply the parking brake to avoid inadvertent creeping.

To set: Fully depress the parking brake pedal. For better holding power, first depress the brake pedal and hold it while setting the parking brake.

To release: Depress the parking brake pedal once again.

To remind you that the parking brake is set, the parking brake reminder light in the instrument panel remains on until you release the parking brake.

CAUTION

Before driving, be sure the parking brake is fully released and the parking brake reminder light is off.

Cruise control

The cruise control allows you to cruise the vehicle at a desired speed over 40 km/h (25 mph) even with your foot off the accelerator pedal.

Your cruising speed can be maintained up or down grades within the limits of engine performance, although a slight speed change may occur when driving up or down the grades. On steeper hills, a greater speed change will occur so it is better to drive without the cruise control.

CAUTION

- To help maintain maximum control of your vehicle, do not use the cruise control when driving in heavy or varying traffic, or on slippery (rainy, icy or snow-covered) or winding roads.
- Avoid vehicle speed increases when driving downhill. If the vehicle speed is too fast in relation to the cruise control set speed, cancel the cruise control then downshift the transmission to use engine braking to slow down.

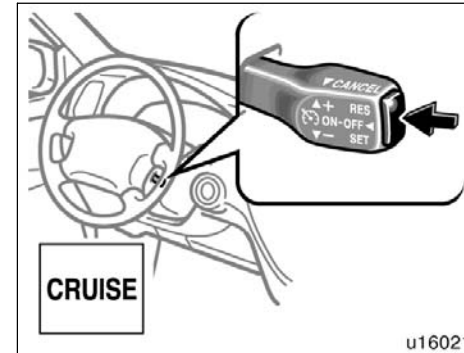

TURNING THE SYSTEM ON

To operate the cruise control, press the "ON-OFF" button. This turns the system on. The indicator light in the instrument panel shows that you can now set the vehicle at a desired cruising speed. Another press will turn the system completely off.

CAUTION

To avoid accidental cruise control engagement, keep the "ON-OFF" switch off when not using the cruise control.

03_SEQUOIA_U (L/O 0301)

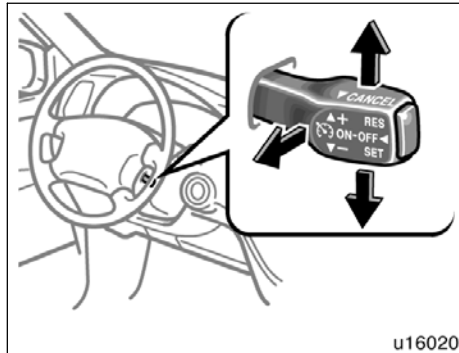

SETTING AT A DESIRED SPEED

The transmission must be in “D” before you set the cruise control speed.

Bring your vehicle to the desired speed, push the lever down in the “- SET” direction and release it. This sets the vehicle at that speed. If the speed is not satisfactory, tap the lever up for a faster speed, or tap it down for a slower speed. Each tap changes the set speed by 1.6 km/h (1.0 mph). You can now take your foot off the accelerator pedal.

If you need acceleration—for example, when passing—depress the accelerator pedal enough for the vehicle to exceed the set speed. When you release it, the vehicle will return to the speed set prior to the acceleration.

CANCELLING THE PRESET SPEED

You can cancel the preset speed by:

- Pulling the lever in the “CANCEL” direction and releasing it.
- Depressing the brake pedal.

If the vehicle speed falls below about 40 km/h (25 mph), the preset speed will automatically cancel out.

If the vehicle speed drops 16 km/h (10 mph) below the preset speed, the preset speed will also automatically cancel out.

If the preset speed automatically cancels out other than for the above cases, have your vehicle checked by your Toyota dealer at the earliest opportunity.

RESETTING TO A FASTER SPEED

Push the lever up in the “+ RES” direction and hold it. Release the lever when the desired speed is attained. While the lever is held up, the vehicle will gradually gain speed.

However, a faster way to reset is to accelerate the vehicle and then push the lever down in the “- SET” direction.

RESETTING TO A SLOWER SPEED

Push the lever down in the “- SET” direction and hold it. Release the lever when the desired speed is attained. While the lever is held down, the vehicle speed will gradually decrease.

However, a faster way to reset is to depress the brake pedal and then push the lever down in the “- SET” direction.

Even if you turn off the overdrive switch, with the cruise control on, engine braking will not be applied because the cruise control is not cancelled. To decrease the vehicle speed, reset to a slower speed with the cruise control lever or depress the brake pedal. If you use the brake pedal, cruise control is cancelled.

RESUMING THE PRESET SPEED

If the preset speed is cancelled by pulling the control lever or by depressing the brake pedal, pushing the lever up in the "+ RES" direction will restore the speed set prior to cancellation.

However, once the vehicle speed falls below about 40 km/h (25 mph), the preset speed will not be resumed.

CRUISE CONTROL FAILURE WARNING

If the "CRUISE" indicator light in the instrument cluster flashes when using the cruise control, press the "ON-OFF" button to turn the system off and then press it again to turn it on.

If any of the following conditions then occurs, there is some trouble in the cruise control system.

- The indicator light does not come on.
- The indicator light flashes again.
- The indicator light goes out after it comes on.

If this is the case, contact your Toyota dealer and have your vehicle inspected.

03_SEQUOIA_U (L/O 0301)

EA09-006

TOYOTA

2/19/2010

ATTACHMENT 11

11-F-1



Customer Product Specification
MK25 Safety Concept
TOYOTA 532N ABS/EBD/BTRAC/ETRAC/VSC/HBA

A I E N 655 66.14
Sheet 152
Page 1 of 206

ALLE RECHTE VORBEHALTEN

EIGENTUM DER CONTINENTAL TEVES AG & CO. OHG

VERTRAULICH

Dieser Informationsträger und die darin enthaltenen Informationen sind Eigentum von Continental Teves AG & Co. oHG (TEVES). Jegliche Vervielfältigung, Offenbarung oder Benutzung dieser Informationen ist ohne vorherige schriftliche Zustimmung von TEVES verboten. TEVES behält sich weltweit alle Rechte auch für den Fall der Erteilung von gewerblichen Schutzrechten vor. Die gleichen Regelungen gelten für diesbezügliche mündliche Mitteilungen entsprechend.



CONFIDENTIAL AND PROPRIETARY
This information carrier and the information it contains are the property of Continental Teves AG & Co. oHG (TEVES). Any reproduction, disclosure or use of either is prohibited without the prior written consent of TEVES. TEVES reserve worldwide all rights also in case of industrial property rights being granted. The same provisions apply to any oral communications related thereto accordingly.

PROPERTY OF CONTINENTAL TEVES AG & CO. OHG

ALL RIGHTS RESERVED



Customer Product Specification
MK25 Safety Concept
TOYOTA 532N ABS/EBD/BTRAC/ETRAC/VSC/HBA

ATE N 655 66.14
Sheet 152
Page 12 of 206

ALLE RECHTE VORBEHALTEN

EIGENTUM DER CONTINENTAL TEVES AG & CO. OHG

VERTRAULICH

Dieser Informationsträger und die darin enthaltenen Informationen sind Eigentum von Continental Teves AG & Co. oHG (TEVES). Jegliche Vervielfältigung, Offenbarung oder Benutzung dieser Informationen ist ohne vorherige schriftliche Zustimmung von TEVES verboten. TEVES behält sich weltweit alle Rechte auch für den Fall der Erteilung von gewerblichen Schutzrechten vor. Die gleichen Regelungen gelten für diesbezügliche mündliche Mitteilungen entsprechend.



CONFIDENTIAL AND PROPRIETARY
This information carrier and the information it contains are the property of Continental Teves AG & Co. oHG (TEVES). Any reproduction, disclosure or use of either is prohibited without the prior written consent of TEVES. TEVES reserve worldwide all rights also in case of industrial property rights being granted. The same provisions apply to any oral communications related thereto accordingly.

PROPERTY OF CONTINENTAL TEVES AG & CO. OHG
ALL RIGHTS RESERVED



Customer Product Specification
MK25 Safety Concept
TOYOTA 532N ABS/EBD/BTRAC/ETRAC/VSC/HBA

ATE N 655 66.14
Sheet 152
Page 13 of 206

ALLE RECHTE VORBEHALTEN

EIGENTUM DER CONTINENTAL TEVES AG & CO. OHG

VERTRAULICH

Dieser Informationsträger und die darin enthaltenen Informationen sind Eigentum von Continental Teves AG & Co. oHG (TEVES). Jegliche Vervielfältigung, Offenbarung oder Benutzung dieser Informationen ist ohne vorherige schriftliche Zustimmung von TEVES verboten. TEVES behält sich weltweit alle Rechte auch für den Fall der Erteilung von gewerblichen Schutzrechten vor. Die gleichen Regelungen gelten für diesbezügliche mündliche Mitteilungen entsprechend.



CONFIDENTIAL AND PROPRIETARY
This information carrier and the information it contains are the property of Continental Teves AG & Co. oHG (TEVES). Any reproduction, disclosure or use of either is prohibited without the prior written consent of TEVES. TEVES reserve worldwide all rights also in case of industrial property rights being granted. The same provisions apply to any oral communications related thereto accordingly.



Customer Product Specification
MK25 Safety Concept
TOYOTA 532N ABS/EBD/BTRAC/ETRAC/VSC/HBA

ATE N 655 66.14
Sheet 152
Page 27 of 206

ALLE RECHTE VORBEHALTEN

EIGENTUM DER CONTINENTAL TEVES AG & CO. OHG

VERTRAULICH

Dieser Informationsträger und die darin enthaltenen Informationen sind Eigentum von Continental Teves AG & Co. oHG (TEVES). Jegliche Vervielfältigung, Offenbarung oder Benutzung dieser Informationen ist ohne vorherige schriftliche Zustimmung von TEVES verboten. TEVES behält sich weltweit alle Rechte auch für den Fall der Erteilung von gewerblichen Schutzrechten vor. Die gleichen Regelungen gelten für diesbezügliche mündliche Mitteilungen entsprechend.



CONFIDENTIAL AND PROPRIETARY
This information carrier and the information it contains are the property of Continental Teves AG & Co. oHG (TEVES). Any reproduction, disclosure or use of either is prohibited without the prior written consent of TEVES. TEVES reserve worldwide all rights also in case of industrial property rights being granted. The same provisions apply to any oral communications related thereto accordingly.

PROPERTY OF CONTINENTAL TEVES AG & CO. OHG
ALL RIGHTS RESERVED



Customer Product Specification
MK25 Safety Concept
TOYOTA 532N ABS/EBD/BTRAC/ETRAC/VSC/HBA

ATE N 655 66.14
Sheet 152
Page 28 of 206

ALLE RECHTE VORBEHALTEN

EIGENTUM DER CONTINENTAL TEVES AG & CO. OHG

VERTRAULICH

Dieser Informationsträger und die darin enthaltenen Informationen sind Eigentum von Continental Teves AG & Co. oHG (TEVES). Jegliche Vervielfältigung, Offenbarung oder Benutzung dieser Informationen ist ohne vorherige schriftliche Zustimmung von TEVES verboten. TEVES behält sich weltweit alle Rechte auch für den Fall der Erteilung von gewerblichen Schutzrechten vor. Die gleichen Regelungen gelten für diesbezügliche mündliche Mitteilungen entsprechend.



ALL RIGHTS RESERVED
PROPERTY OF CONTINENTAL TEVES AG & CO. OHG
This information carrier and the information it contains are the property of Continental Teves AG & Co. oHG (TEVES). Any reproduction, disclosure or use of either is prohibited without the prior written consent of TEVES. TEVES reserve worldwide all rights also in case of industrial property rights being granted. The same provisions apply to any oral communications related thereto accordingly.



Customer Product Specification
MK25 Safety Concept
TOYOTA 532N ABS/EBD/BTRAC/ETRAC/VSC/HBA

ATE N 655 66.14
Sheet 152
Page 29 of 206

ALLE RECHTE VORBEHALTEN

EIGENTUM DER CONTINENTAL TEVES AG & CO. OHG

VERTRAULICH

Dieser Informationsträger und die darin enthaltenen Informationen sind Eigentum von Continental Teves AG & Co. oHG (TEVES). Jegliche Vervielfältigung, Offenbarung oder Benutzung dieser Informationen ist ohne vorherige schriftliche Zustimmung von TEVES verboten. TEVES behält sich weltweit alle Rechte auch für den Fall der Erteilung von gewerblichen Schutzrechten vor. Die gleichen Regelungen gelten für diesbezügliche mündliche Mitteilungen entsprechend.

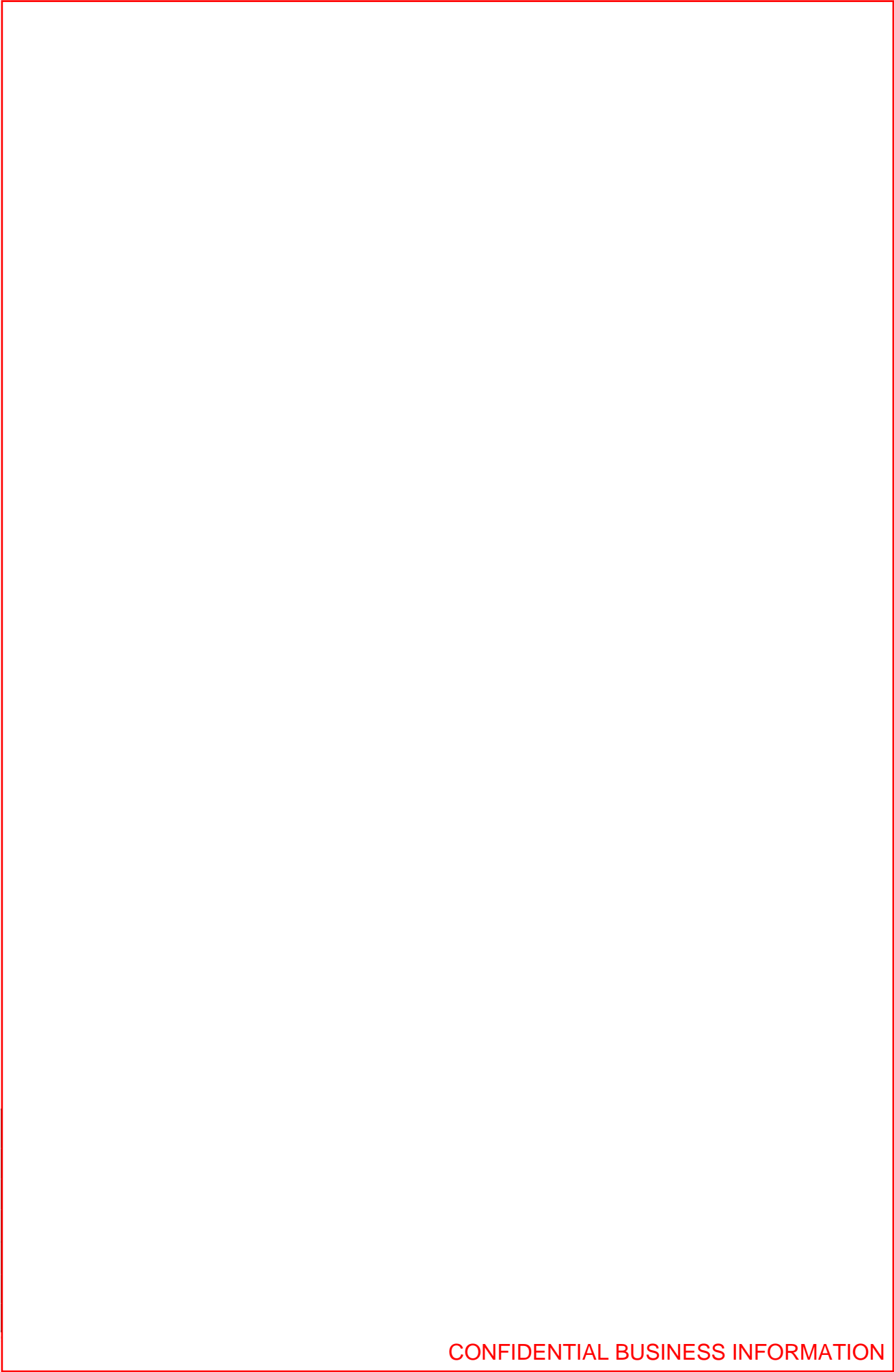



Customer Product Specification
MK25 Safety Concept
TOYOTA 532N ABS/EBD/BTRAC/ETRAC/VSC/HBA

ATE N 655 66.14
Sheet 152
Page 30 of 206

ALLE RECHTE VORBEHALTEN

EIGENTUM DER CONTINENTAL TEVES AG & CO. OHG

VERTRAULICH

Dieser Informationsträger und die darin enthaltenen Informationen sind Eigentum von Continental Teves AG & Co. oHG (TEVES). Jegliche Vervielfältigung, Offenbarung oder Benutzung dieser Informationen ist ohne vorherige schriftliche Zustimmung von TEVES verboten. TEVES behält sich weltweit alle Rechte auch für den Fall der Erteilung von gewerblichen Schutzrechten vor. Die gleichen Regelungen gelten für diesbezügliche mündliche Mitteilungen entsprechend.

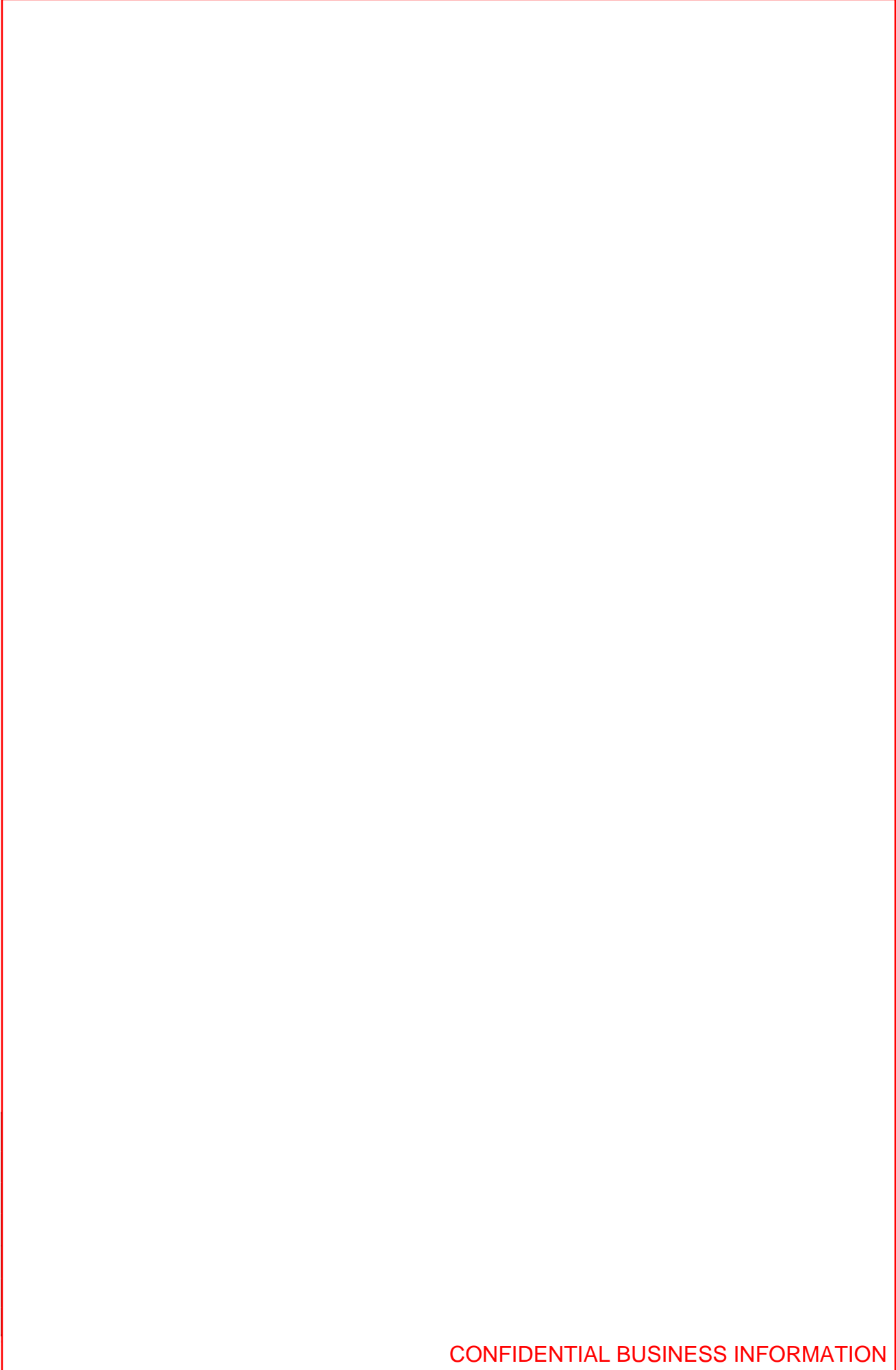

CONFIDENTIAL AND PROPRIETARY
This information carrier and the information it contains are the property of Continental Teves AG & Co. oHG (TEVES). Any reproduction, disclosure or use of either is prohibited without the prior written consent of TEVES. TEVES reserve worldwide all rights also in case of industrial property rights being granted. The same provisions apply to any oral communications related thereto accordingly.

PROPERTY OF CONTINENTAL TEVES AG & CO. OHG
ALL RIGHTS RESERVED



Customer Product Specification
MK25 Safety Concept
TOYOTA 532N ABS/EBD/BTRAC/ETRAC/VSC/HBA

ATE N 655 66.14
Sheet 152
Page 32 of 206

ALLE RECHTE VORBEHALTEN

EIGENTUM DER CONTINENTAL TEVES AG & CO. OHG

VERTRAULICH

Dieser Informationsträger und die darin enthaltenen Informationen sind Eigentum von Continental Teves AG & Co. oHG (TEVES). Jegliche Vervielfältigung, Offenbarung oder Benutzung dieser Informationen ist ohne vorherige schriftliche Zustimmung von TEVES verboten. TEVES behält sich weltweit alle Rechte auch für den Fall der Erteilung von gewerblichen Schutzrechten vor. Die gleichen Regelungen gelten für diesbezügliche mündliche Mitteilungen entsprechend.





Customer Product Specification
MK25 Safety Concept
TOYOTA 532N ABS/EBD/BTRAC/ETRAC/VSC/HBA

ATE N 655 66.14
Sheet 152
Page 33 of 206

ALLE RECHTE VORBEHALTEN

EIGENTUM DER CONTINENTAL TEVES AG & CO. OHG

VERTRAULICH

Dieser Informationsträger und die darin enthaltenen Informationen sind Eigentum von Continental Teves AG & Co. oHG (TEVES). Jegliche Vervielfältigung, Offenbarung oder Benutzung dieser Informationen ist ohne vorherige schriftliche Zustimmung von TEVES verboten. TEVES behält sich weltweit alle Rechte auch für den Fall der Erteilung von gewerblichen Schutzrechten vor. Die gleichen Regelungen gelten für diesbezügliche mündliche Mitteilungen entsprechend.

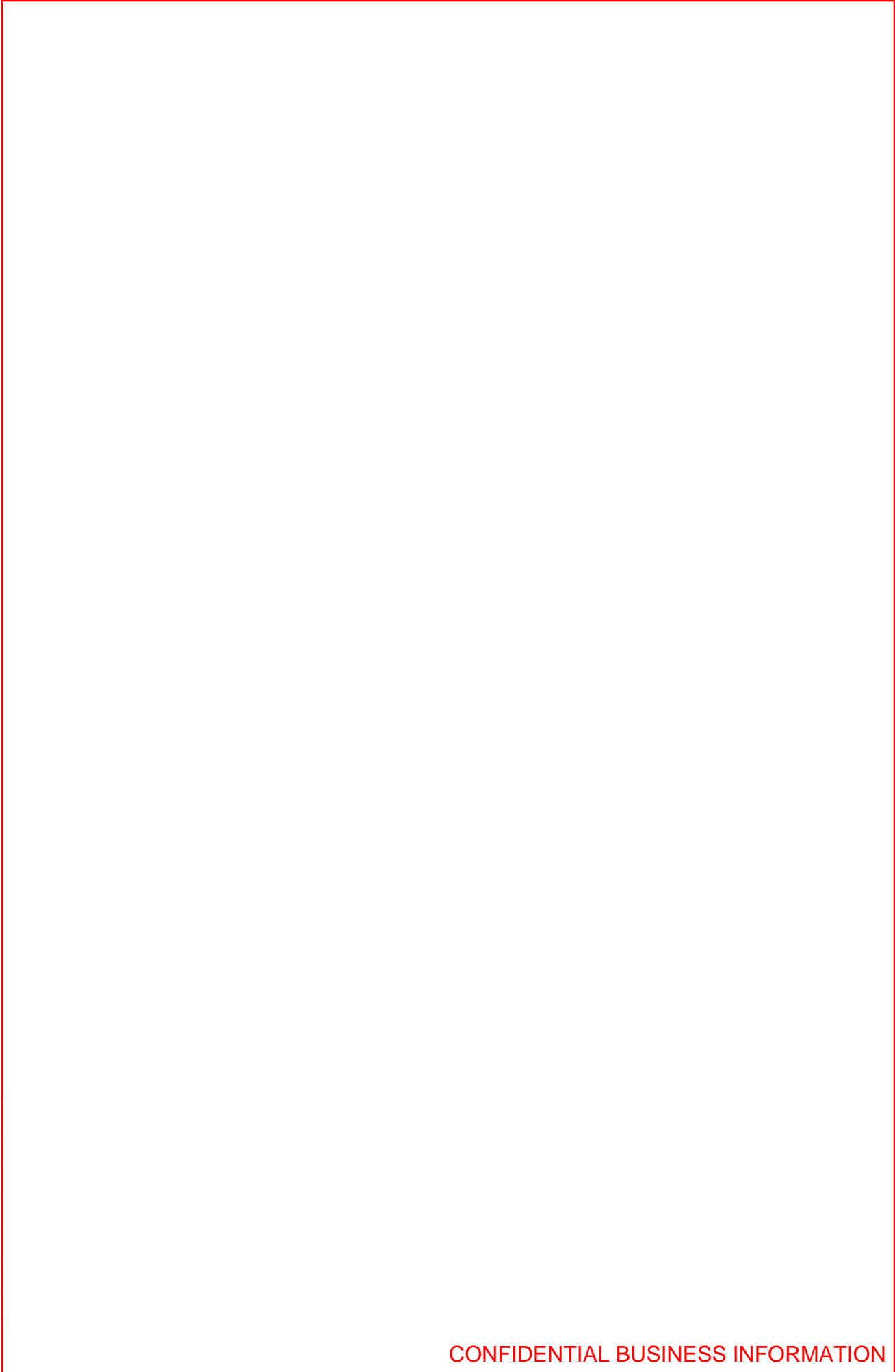



Customer Product Specification
MK25 Safety Concept
TOYOTA 532N ABS/EBD/BTRAC/ETRAC/VSC/HBA

ATE N 655 66.14
Sheet 152
Page 34 of 206

ALLE RECHTE VORBEHALTEN

EIGENTUM DER CONTINENTAL TEVES AG & CO. OHG

VERTRAULICH

Dieser Informationsträger und die darin enthaltenen Informationen sind Eigentum von Continental Teves AG & Co. oHG (TEVES). Jegliche Vervielfältigung, Offenbarung oder Benutzung dieser Informationen ist ohne vorherige schriftliche Zustimmung von TEVES verboten. TEVES behält sich weltweit alle Rechte auch für den Fall der Erteilung von gewerblichen Schutzrechten vor. Die gleichen Regelungen gelten für diesbezügliche mündliche Mitteilungen entsprechend.

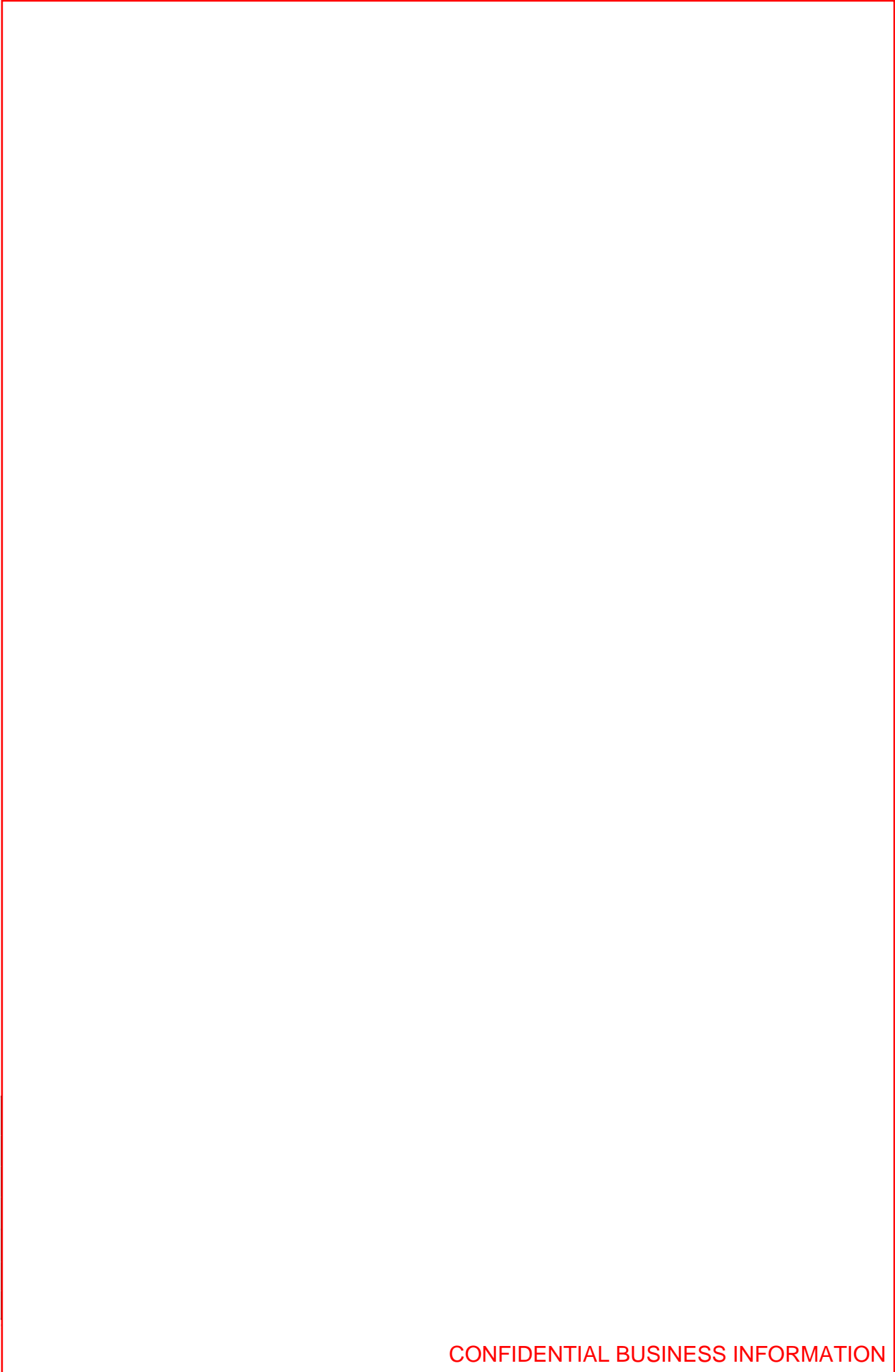



Customer Product Specification
MK25 Safety Concept
TOYOTA 532N ABS/EBD/BTRAC/ETRAC/VSC/HBA

ATE N 655 66.14
Sheet 152
Page 35 of 206

ALLE RECHTE VORBEHALTEN

EIGENTUM DER CONTINENTAL TEVES AG & CO. OHG

VERTRAULICH

Dieser Informationsträger und die darin enthaltenen Informationen sind Eigentum von Continental Teves AG & Co. oHG (TEVES). Jegliche Vervielfältigung, Offenbarung oder Benutzung dieser Informationen ist ohne vorherige schriftliche Zustimmung von TEVES verboten. TEVES behält sich weltweit alle Rechte auch für den Fall der Erteilung von gewerblichen Schutzrechten vor. Die gleichen Regelungen gelten für diesbezügliche mündliche Mitteilungen entsprechend.

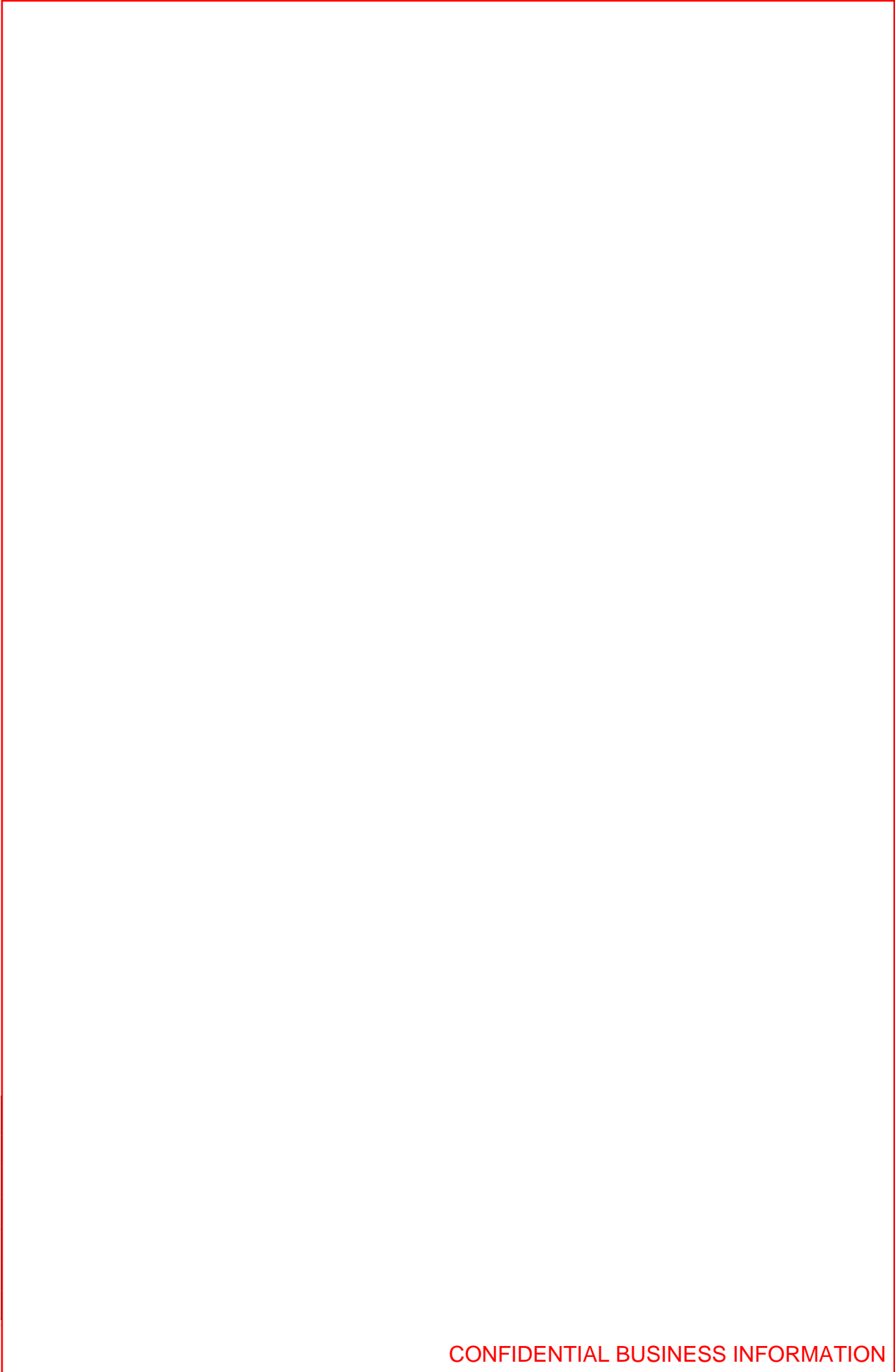



Customer Product Specification
MK25 Safety Concept
TOYOTA 532N ABS/EBD/BTRAC/ETRAC/VSC/HBA

ATE N 655 66.14
Sheet 152
Page 36 of 206

ALLE RECHTE VORBEHALTEN

EIGENTUM DER CONTINENTAL TEVES AG & CO. OHG

VERTRAULICH

Dieser Informationsträger und die darin enthaltenen Informationen sind Eigentum von Continental Teves AG & Co. oHG (TEVES). Jegliche Vervielfältigung, Offenbarung oder Benutzung dieser Informationen ist ohne vorherige schriftliche Zustimmung von TEVES verboten. TEVES behält sich weltweit alle Rechte auch für den Fall der Erteilung von gewerblichen Schutzrechten vor. Die gleichen Regelungen gelten für diesbezügliche mündliche Mitteilungen entsprechend.

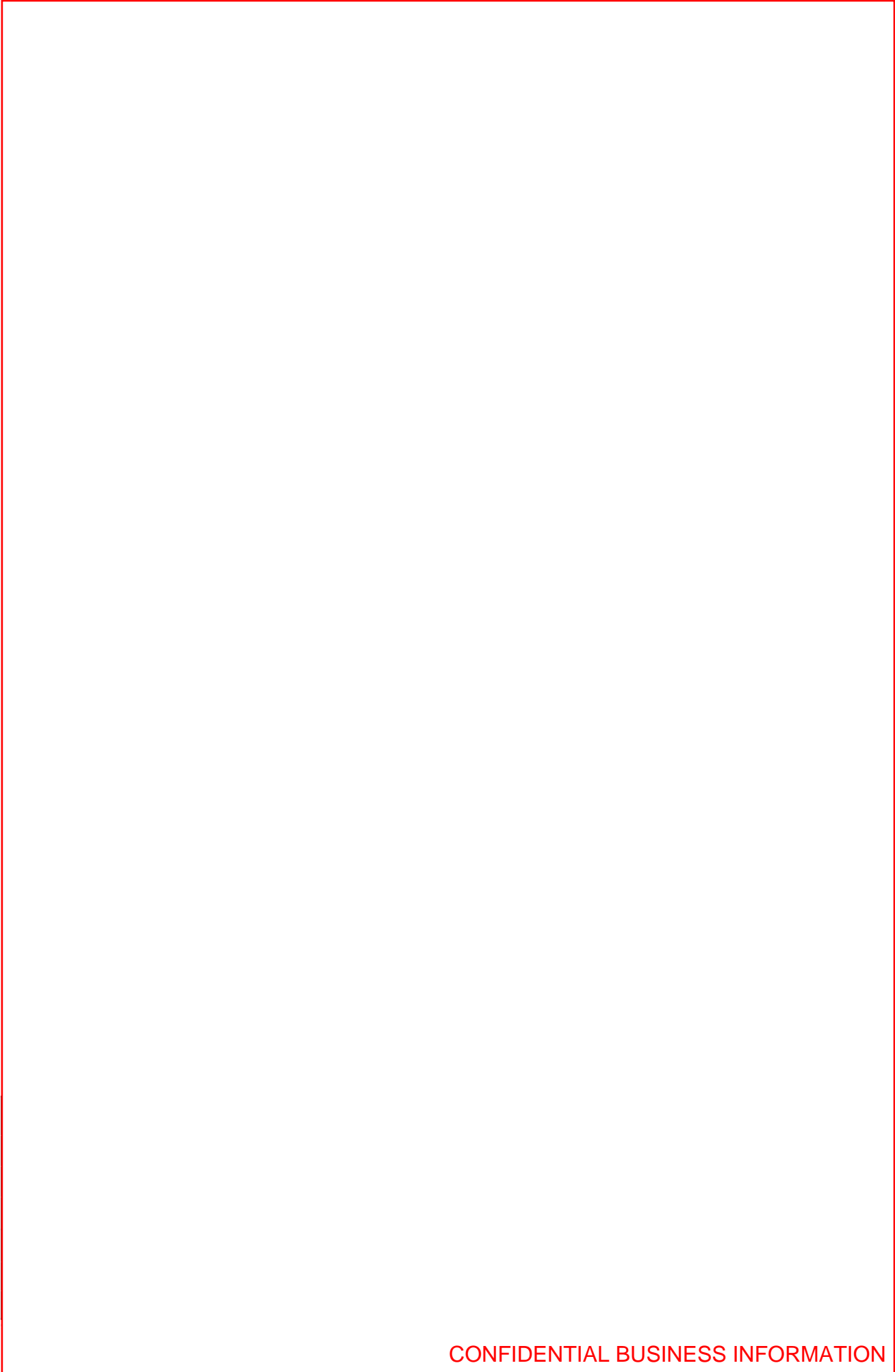

CONFIDENTIAL AND PROPRIETARY
This information carrier and the information it contains are the property of Continental Teves AG & Co. oHG (TEVES). Any reproduction, disclosure or use of either is prohibited without the prior written consent of TEVES. TEVES reserve worldwide all rights also in case of industrial property rights being granted. The same provisions apply to any oral communications related thereto accordingly.

PROPERTY OF CONTINENTAL TEVES AG & CO. OHG
ALL RIGHTS RESERVED



Customer Product Specification
MK25 Safety Concept
TOYOTA 532N ABS/EBD/BTRAC/ETRAC/VSC/HBA

ATE N 655 66.14
Sheet 152
Page 37 of 206

ALLE RECHTE VORBEHALTEN

EIGENTUM DER CONTINENTAL TEVES AG & CO. OHG

VERTRAULICH

Dieser Informationsträger und die darin enthaltenen Informationen sind Eigentum von Continental Teves AG & Co. oHG (TEVES). Jegliche Vervielfältigung, Offenbarung oder Benutzung dieser Informationen ist ohne vorherige schriftliche Zustimmung von TEVES verboten. TEVES behält sich weltweit alle Rechte auch für den Fall der Erteilung von gewerblichen Schutzrechten vor. Die gleichen Regelungen gelten für diesbezügliche mündliche Mitteilungen entsprechend.

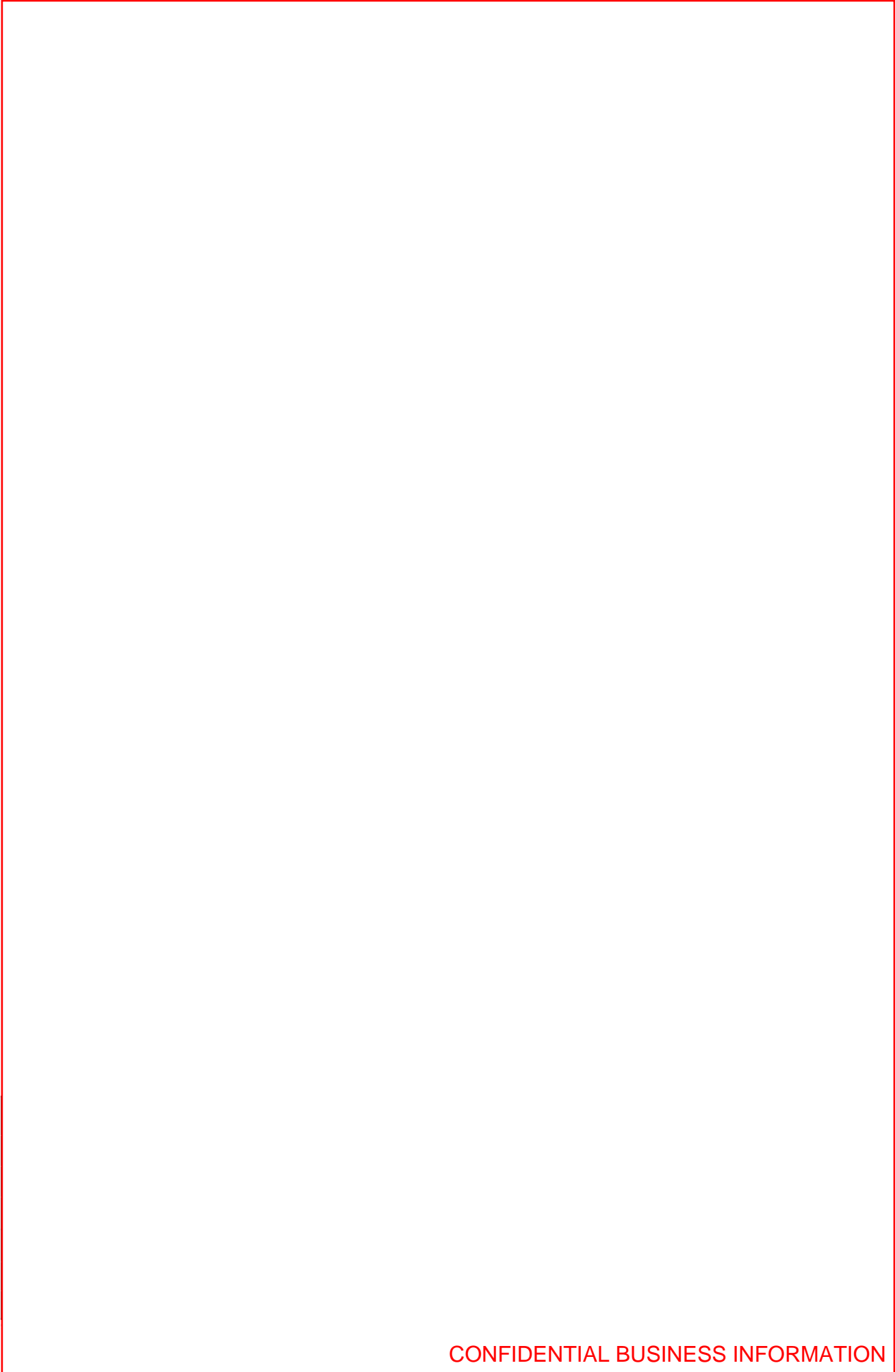

CONFIDENTIAL AND PROPRIETARY
This information carrier and the information it contains are the property of Continental Teves AG & Co. oHG (TEVES). Any reproduction, disclosure or use of either is prohibited without the prior written consent of TEVES. TEVES reserve worldwide all rights also in case of industrial property rights being granted. The same provisions apply to any oral communications related thereto accordingly.



Customer Product Specification
MK25 Safety Concept
TOYOTA 532N ABS/EBD/BTRAC/ETRAC/VSC/HBA

ATE N 655 66.14
Sheet 152
Page 38 of 206

ALLE RECHTE VORBEHALTEN

EIGENTUM DER CONTINENTAL TEVES AG & CO. OHG

VERTRAULICH

Dieser Informationsträger und die darin enthaltenen Informationen sind Eigentum von Continental Teves AG & Co. oHG (TEVES). Jegliche Vervielfältigung, Offenbarung oder Benutzung dieser Informationen ist ohne vorherige schriftliche Zustimmung von TEVES verboten. TEVES behält sich weltweit alle Rechte auch für den Fall der Erteilung von gewerblichen Schutzrechten vor. Die gleichen Regelungen gelten für diesbezügliche mündliche Mitteilungen entsprechend.





Customer Product Specification
MK25 Safety Concept
TOYOTA 532N ABS/EBD/BTRAC/ETRAC/VSC/HBA

ATE N 655 66.14
Sheet 152
Page 39 of 206

ALLE RECHTE VORBEHALTEN

EIGENTUM DER CONTINENTAL TEVES AG & CO. OHG

VERTRAULICH

Dieser Informationsträger und die darin enthaltenen Informationen sind Eigentum von Continental Teves AG & Co. oHG (TEVES). Jegliche Vervielfältigung, Offenbarung oder Benutzung dieser Informationen ist ohne vorherige schriftliche Zustimmung von TEVES verboten. TEVES behält sich weltweit alle Rechte auch für den Fall der Erteilung von gewerblichen Schutzrechten vor. Die gleichen Regelungen gelten für diesbezügliche mündliche Mitteilungen entsprechend.

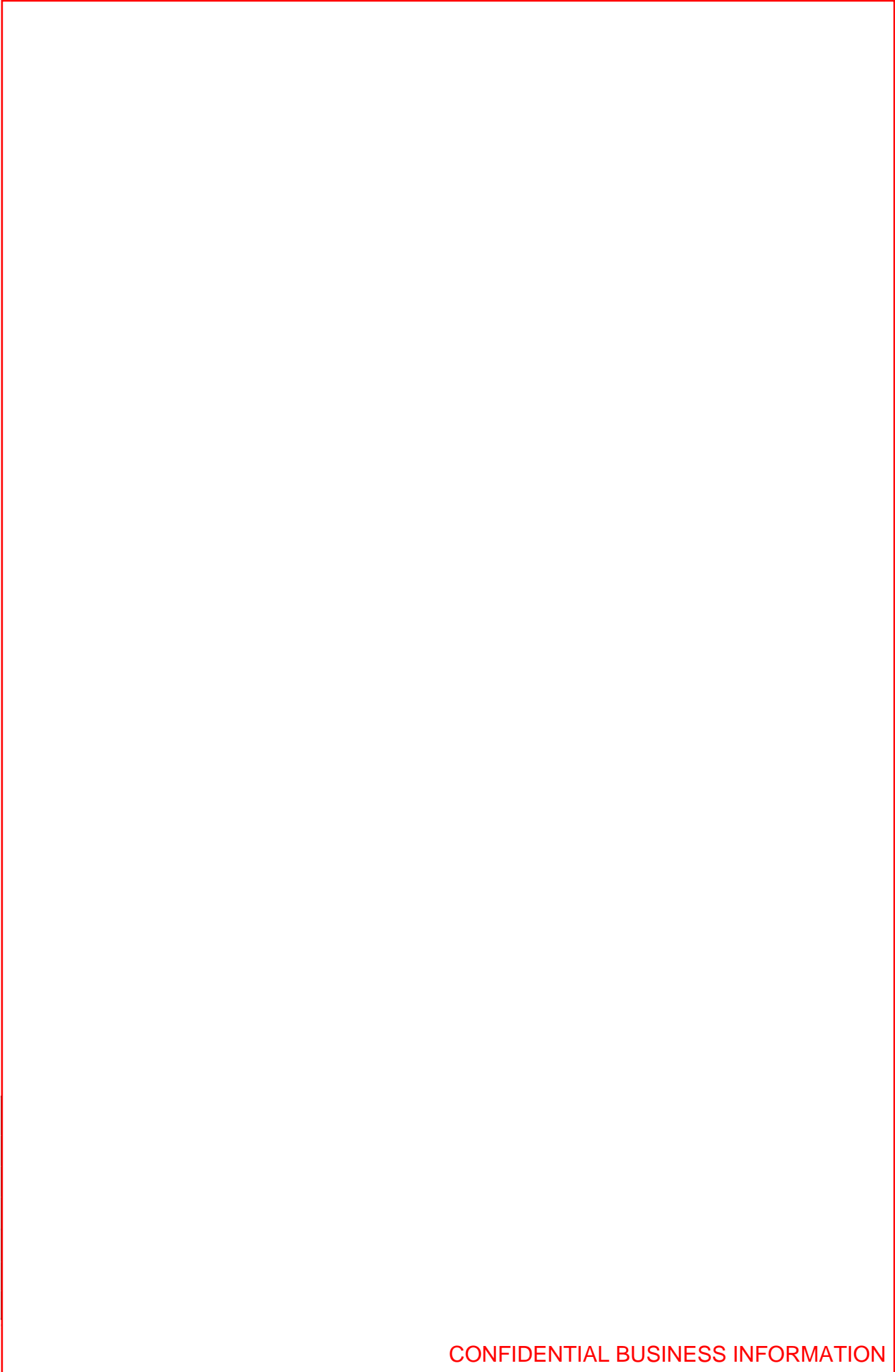



Customer Product Specification
MK25 Safety Concept
TOYOTA 532N ABS/EBD/BTRAC/ETRAC/VSC/HBA

ATE N 655 66.14
Sheet 152
Page 40 of 206

ALLE RECHTE VORBEHALTEN

EIGENTUM DER CONTINENTAL TEVES AG & CO. OHG

VERTRAULICH

Dieser Informationsträger und die darin enthaltenen Informationen sind Eigentum von Continental Teves AG & Co. oHG (TEVES). Jegliche Vervielfältigung, Offenbarung oder Benutzung dieser Informationen ist ohne vorherige schriftliche Zustimmung von TEVES verboten. TEVES behält sich weltweit alle Rechte auch für den Fall der Erteilung von gewerblichen Schutzrechten vor. Die gleichen Regelungen gelten für diesbezügliche mündliche Mitteilungen entsprechend.





Customer Product Specification
MK25 Safety Concept
TOYOTA 532N ABS/EBD/BTRAC/ETRAC/VSC/HBA

ATE N 655 66.14
Sheet 152
Page 41 of 206

ALLE RECHTE VORBEHALTEN

EIGENTUM DER CONTINENTAL TEVES AG & CO. OHG

VERTRAULICH

Dieser Informationsträger und die darin enthaltenen Informationen sind Eigentum von Continental Teves AG & Co. oHG (TEVES). Jegliche Vervielfältigung, Offenbarung oder Benutzung dieser Informationen ist ohne vorherige schriftliche Zustimmung von TEVES verboten. TEVES behält sich weltweit alle Rechte auch für den Fall der Erteilung von gewerblichen Schutzrechten vor. Die gleichen Regelungen gelten für diesbezügliche mündliche Mitteilungen entsprechend.

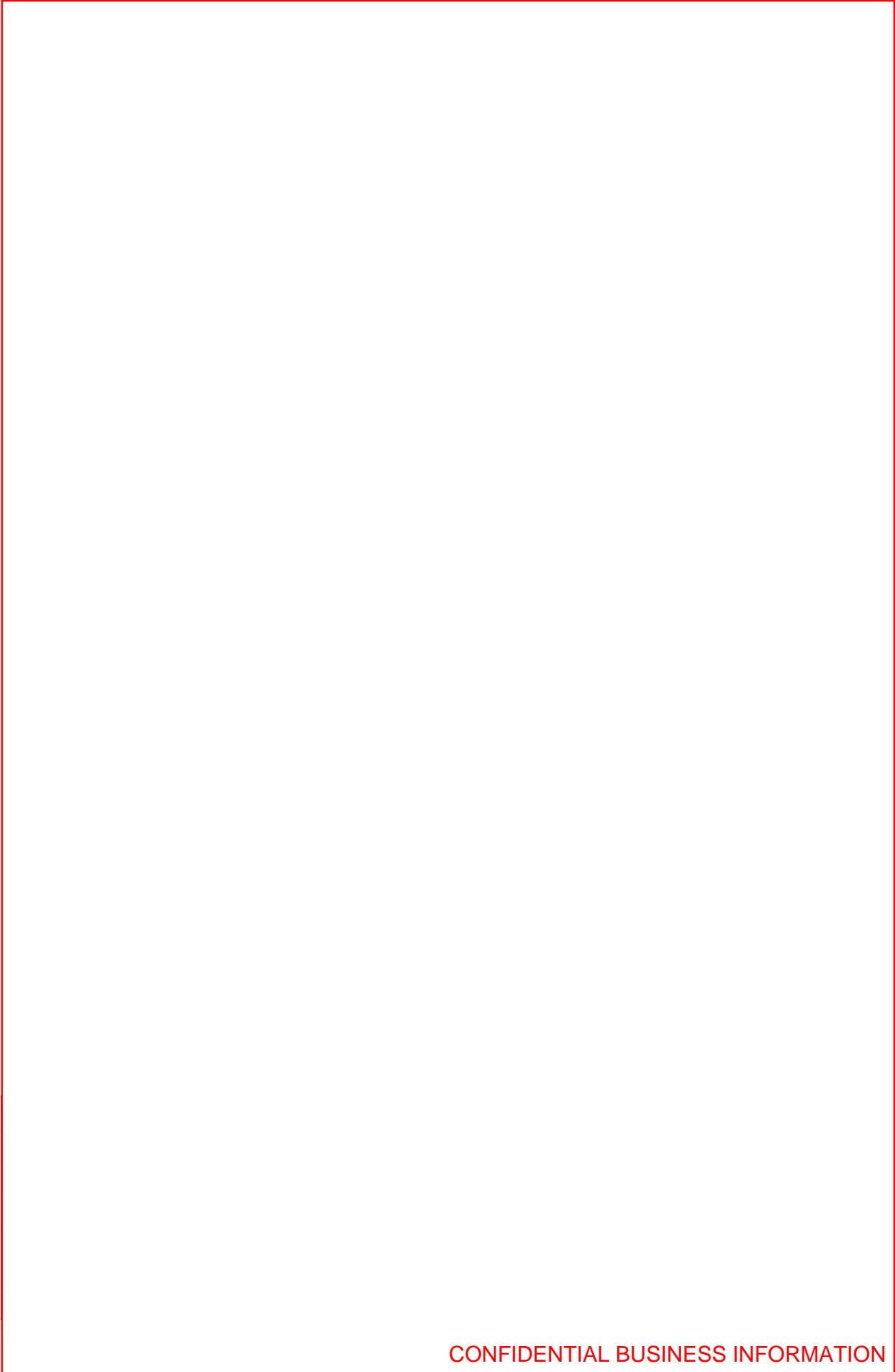



Customer Product Specification
MK25 Safety Concept
TOYOTA 532N ABS/EBD/BTRAC/ETRAC/VSC/HBA

ATE N 655 66.14
Sheet 152
Page 42 of 206

ALLE RECHTE VORBEHALTEN

EIGENTUM DER CONTINENTAL TEVES AG & CO. OHG

VERTRAULICH

Dieser Informationsträger und die darin enthaltenen Informationen sind Eigentum von Continental Teves AG & Co. oHG (TEVES). Jegliche Vervielfältigung, Offenbarung oder Benutzung dieser Informationen ist ohne vorherige schriftliche Zustimmung von TEVES verboten. TEVES behält sich weltweit alle Rechte auch für den Fall der Erteilung von gewerblichen Schutzrechten vor. Die gleichen Regelungen gelten für diesbezügliche mündliche Mitteilungen entsprechend.

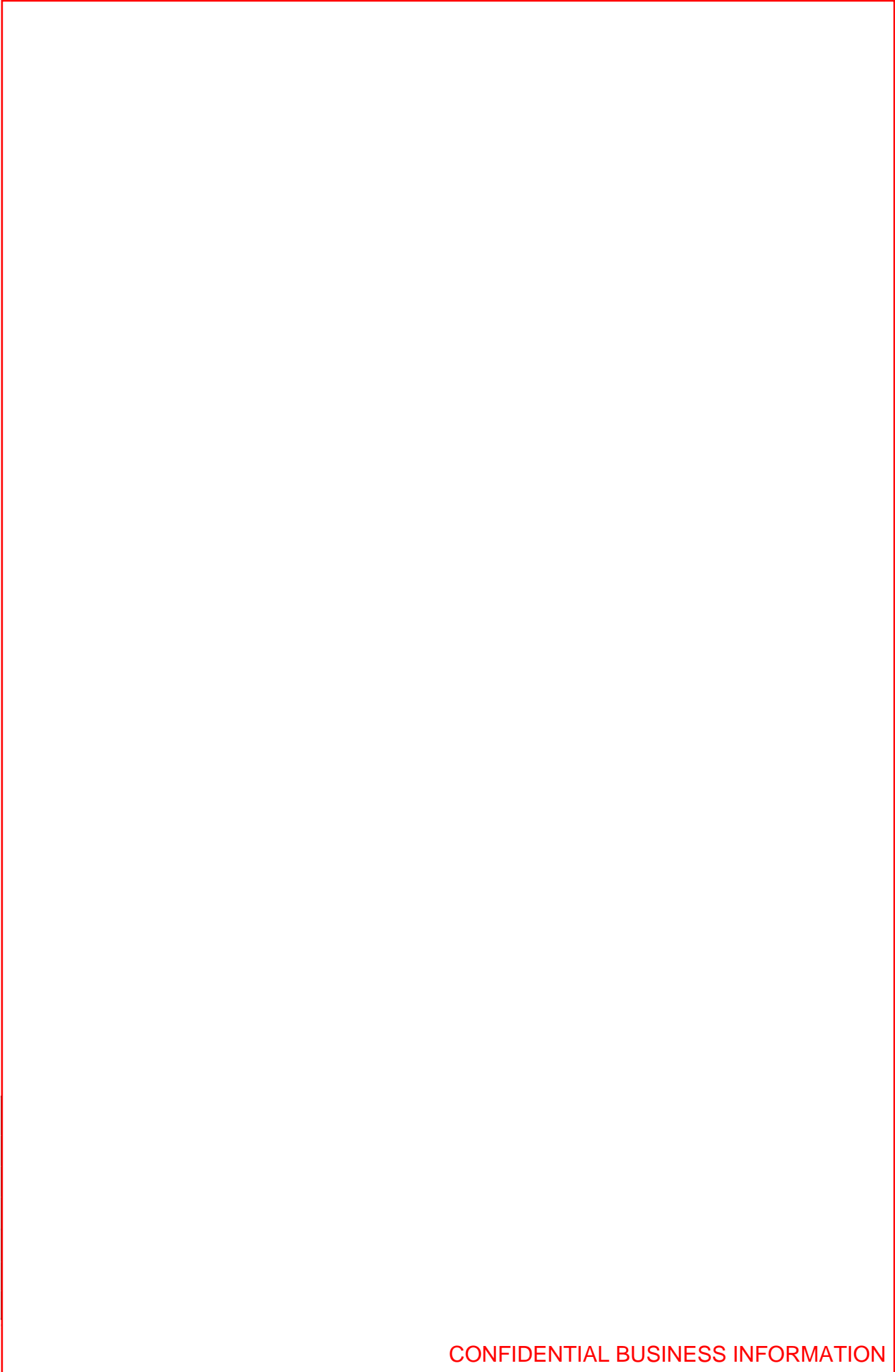

CONFIDENTIAL AND PROPRIETARY
This information carrier and the information it contains are the property of Continental Teves AG & Co. oHG (TEVES). Any reproduction, disclosure or use of either is prohibited without the prior written consent of TEVES. TEVES reserve worldwide all rights also in case of industrial property rights being granted. The same provisions apply to any oral communications related thereto accordingly.

PROPERTY OF CONTINENTAL TEVES AG & CO. OHG
ALL RIGHTS RESERVED



Customer Product Specification
MK25 Safety Concept
TOYOTA 532N ABS/EBD/BTRAC/ETRAC/VSC/HBA

ATE N 655 66.14
Sheet 152
Page 43 of 206

ALLE RECHTE VORBEHALTEN

EIGENTUM DER CONTINENTAL TEVES AG & CO. OHG

VERTRAULICH

Dieser Informationsträger und die darin enthaltenen Informationen sind Eigentum von Continental Teves AG & Co. oHG (TEVES). Jegliche Vervielfältigung, Offenbarung oder Benutzung dieser Informationen ist ohne vorherige schriftliche Zustimmung von TEVES verboten. TEVES behält sich weltweit alle Rechte auch für den Fall der Erteilung von gewerblichen Schutzrechten vor. Die gleichen Regelungen gelten für diesbezügliche mündliche Mitteilungen entsprechend.

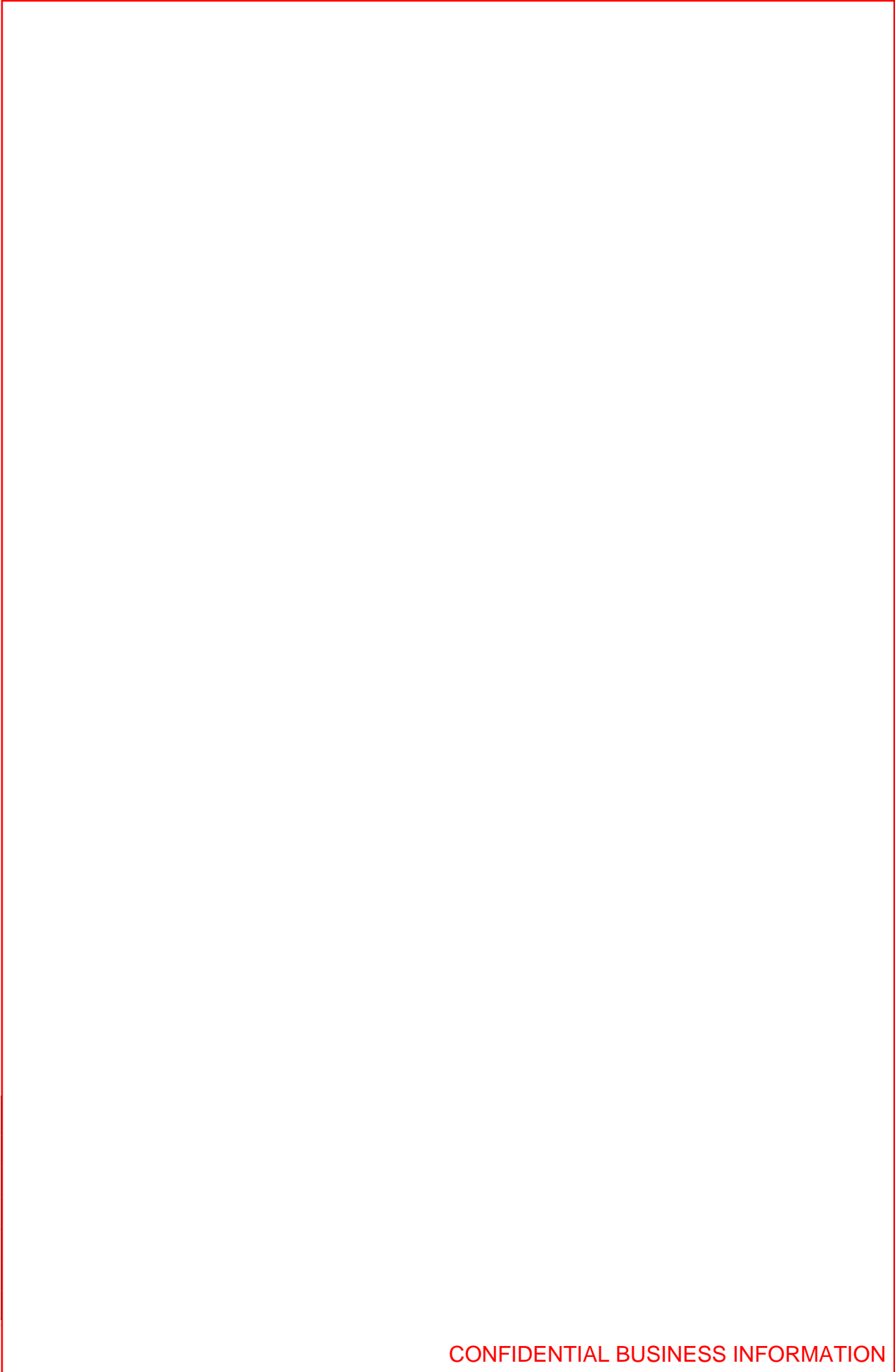



Customer Product Specification
MK25 Safety Concept
TOYOTA 532N ABS/EBD/BTRAC/ETRAC/VSC/HBA

ATE N 655 66.14
Sheet 152
Page 44 of 206

ALLE RECHTE VORBEHALTEN

EIGENTUM DER CONTINENTAL TEVES AG & CO. OHG

VERTRAULICH

Dieser Informationsträger und die darin enthaltenen Informationen sind Eigentum von Continental Teves AG & Co. oHG (TEVES). Jegliche Vervielfältigung, Offenbarung oder Benutzung dieser Informationen ist ohne vorherige schriftliche Zustimmung von TEVES verboten. TEVES behält sich weltweit alle Rechte auch für den Fall der Erteilung von gewerblichen Schutzrechten vor. Die gleichen Regelungen gelten für diesbezügliche mündliche Mitteilungen entsprechend.

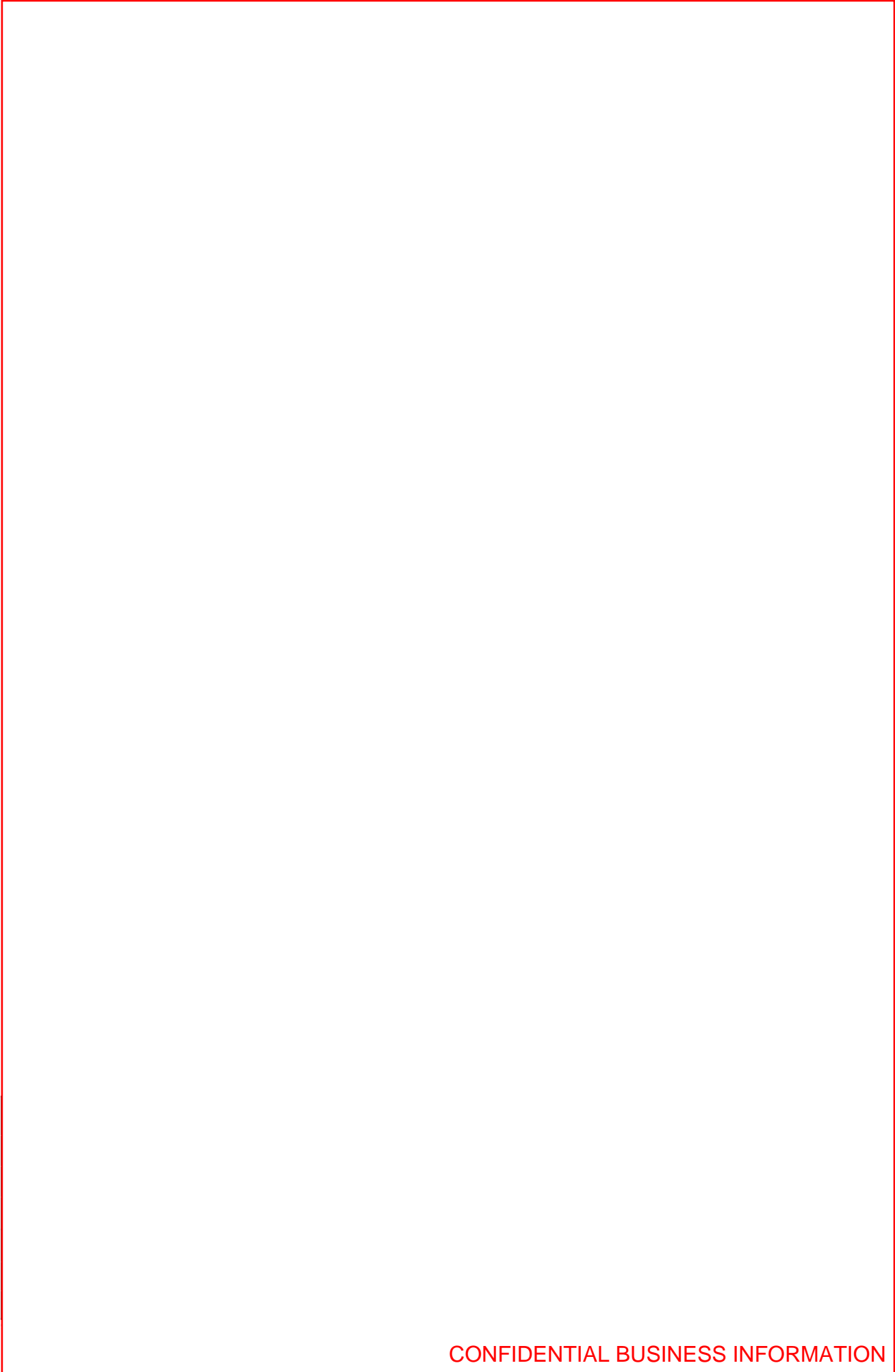

CONFIDENTIAL AND PROPRIETARY
This information carrier and the information it contains are the property of Continental Teves AG & Co. oHG (TEVES). Any reproduction, disclosure or use of either is prohibited without the prior written consent of TEVES. TEVES reserve worldwide all rights also in case of industrial property rights being granted. The same provisions apply to any oral communications related thereto accordingly.

PROPERTY OF CONTINENTAL TEVES AG & CO. OHG
ALL RIGHTS RESERVED



Customer Product Specification
MK25 Safety Concept
TOYOTA 532N ABS/EBD/BTRAC/ETRAC/VSC/HBA

ATE N 655 66.14
Sheet 152
Page 45 of 206

ALLE RECHTE VORBEHALTEN

EIGENTUM DER CONTINENTAL TEVES AG & CO. OHG

VERTRAULICH

Dieser Informationsträger und die darin enthaltenen Informationen sind Eigentum von Continental Teves AG & Co. oHG (TEVES). Jegliche Vervielfältigung, Offenbarung oder Benutzung dieser Informationen ist ohne vorherige schriftliche Zustimmung von TEVES verboten. TEVES behält sich weltweit alle Rechte auch für den Fall der Erteilung von gewerblichen Schutzrechten vor. Die gleichen Regelungen gelten für diesbezügliche mündliche Mitteilungen entsprechend.





Customer Product Specification
MK25 Safety Concept
TOYOTA 532N ABS/EBD/BTRAC/ETRAC/VSC/HBA

ATE N 655 66.14
Sheet 152
Page 46 of 206

ALLE RECHTE VORBEHALTEN

EIGENTUM DER CONTINENTAL TEVES AG & CO. OHG

VERTRAULICH

Dieser Informationsträger und die darin enthaltenen Informationen sind Eigentum von Continental Teves AG & Co. oHG (TEVES). Jegliche Vervielfältigung, Offenbarung oder Benutzung dieser Informationen ist ohne vorherige schriftliche Zustimmung von TEVES verboten. TEVES behält sich weltweit alle Rechte auch für den Fall der Erteilung von gewerblichen Schutzrechten vor. Die gleichen Regelungen gelten für diesbezügliche mündliche Mitteilungen entsprechend.



CONFIDENTIAL AND PROPRIETARY
This information carrier and the information it contains are the property of Continental Teves AG & Co. oHG (TEVES). Any reproduction, disclosure or use of either is prohibited without the prior written consent of TEVES. TEVES reserve worldwide all rights also in case of industrial property rights being granted. The same provisions apply to any oral communications related thereto accordingly.

PROPERTY OF CONTINENTAL TEVES AG & CO. OHG
ALL RIGHTS RESERVED



Customer Product Specification
MK25 Safety Concept
TOYOTA 532N ABS/EBD/BTRAC/ETRAC/VSC/HBA

ATE N 655 66.14
Sheet 152
Page 47 of 206

ALLE RECHTE VORBEHALTEN

EIGENTUM DER CONTINENTAL TEVES AG & CO. OHG

VERTRAULICH

Dieser Informationsträger und die darin enthaltenen Informationen sind Eigentum von Continental Teves AG & Co. oHG (TEVES). Jegliche Vervielfältigung, Offenbarung oder Benutzung dieser Informationen ist ohne vorherige schriftliche Zustimmung von TEVES verboten. TEVES behält sich weltweit alle Rechte auch für den Fall der Erteilung von gewerblichen Schutzrechten vor. Die gleichen Regelungen gelten für diesbezügliche mündliche Mitteilungen entsprechend.

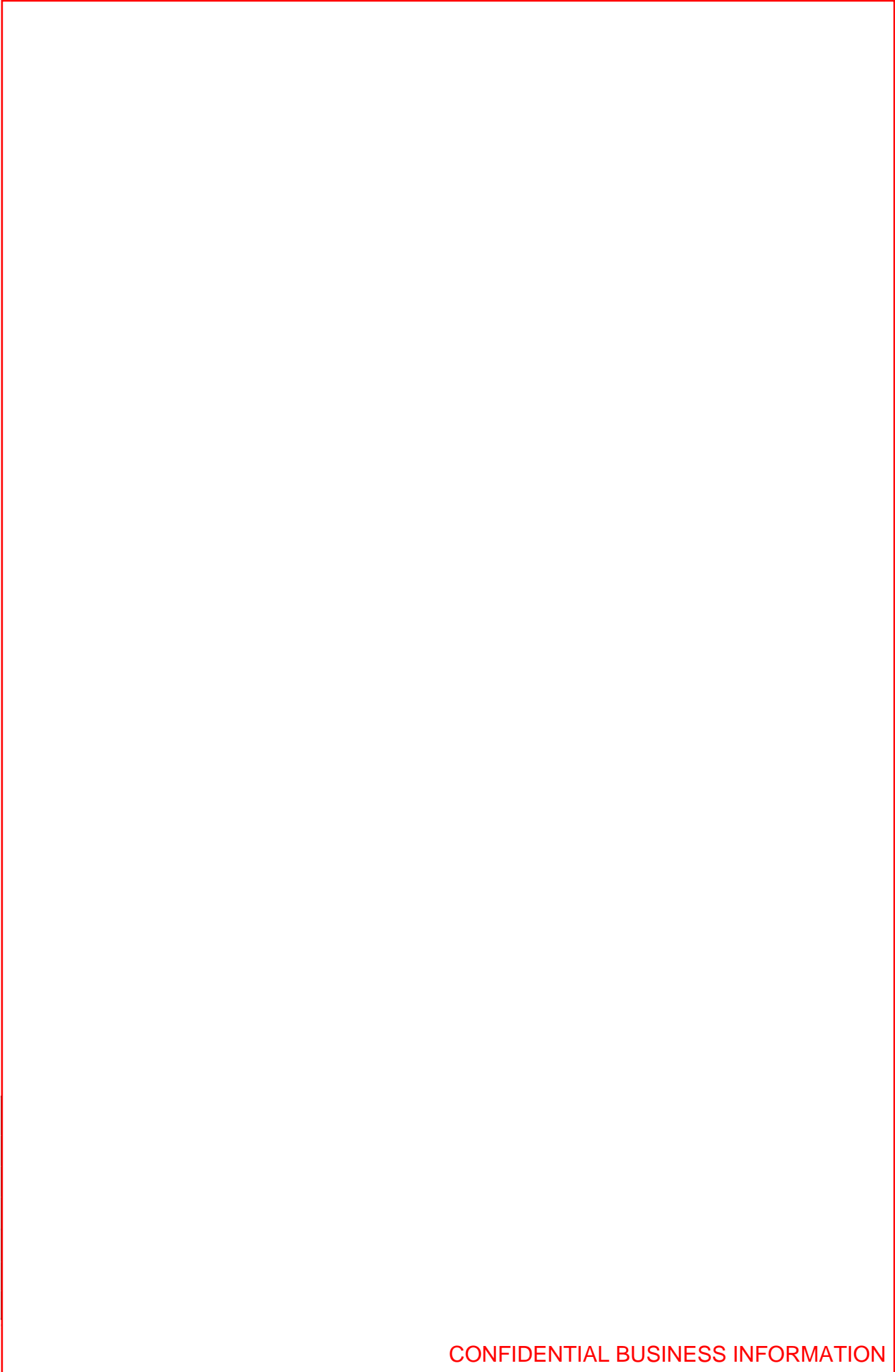

CONFIDENTIAL AND PROPRIETARY
This information carrier and the information it contains are the property of Continental Teves AG & Co. oHG (TEVES). Any reproduction, disclosure or use of either is prohibited without the prior written consent of TEVES. TEVES reserve worldwide all rights also in case of industrial property rights being granted. The same provisions apply to any oral communications related thereto accordingly.

PROPERTY OF CONTINENTAL TEVES AG & CO. OHG
ALL RIGHTS RESERVED



Customer Product Specification
MK25 Safety Concept
TOYOTA 532N ABS/EBD/BTRAC/ETRAC/VSC/HBA

ATE N 655 66.14
Sheet 152
Page 48 of 206

ALLE RECHTE VORBEHALTEN

EIGENTUM DER CONTINENTAL TEVES AG & CO. OHG

VERTRAULICH

Dieser Informationsträger und die darin enthaltenen Informationen sind Eigentum von Continental Teves AG & Co. oHG (TEVES). Jegliche Vervielfältigung, Offenbarung oder Benutzung dieser Informationen ist ohne vorherige schriftliche Zustimmung von TEVES verboten. TEVES behält sich weltweit alle Rechte auch für den Fall der Erteilung von gewerblichen Schutzrechten vor. Die gleichen Regelungen gelten für diesbezügliche mündliche Mitteilungen entsprechend.



CONFIDENTIAL AND PROPRIETARY
This information carrier and the information it contains are the property of Continental Teves AG & Co. oHG (TEVES). Any reproduction, disclosure or use of either is prohibited without the prior written consent of TEVES. TEVES reserve worldwide all rights also in case of industrial property rights being granted. The same provisions apply to any oral communications related thereto accordingly.

PROPERTY OF CONTINENTAL TEVES AG & CO. OHG
ALL RIGHTS RESERVED



Customer Product Specification
MK25 Safety Concept
TOYOTA 532N ABS/EBD/BTRAC/ETRAC/VSC/HBA

ATE N 655 66.14
Sheet 152
Page 49 of 206

ALLE RECHTE VORBEHALTEN

EIGENTUM DER CONTINENTAL TEVES AG & CO. OHG

VERTRAULICH

Dieser Informationsträger und die darin enthaltenen Informationen sind Eigentum von Continental Teves AG & Co. oHG (TEVES). Jegliche Vervielfältigung, Offenbarung oder Benutzung dieser Informationen ist ohne vorherige schriftliche Zustimmung von TEVES verboten. TEVES behält sich weltweit alle Rechte auch für den Fall der Erteilung von gewerblichen Schutzrechten vor. Die gleichen Regelungen gelten für diesbezügliche mündliche Mitteilungen entsprechend.





Customer Product Specification
MK25 Safety Concept
TOYOTA 532N ABS/EBD/BTRAC/ETRAC/VSC/HBA

ATE N 655 66.14
Sheet 152
Page 50 of 206

ALLE RECHTE VORBEHALTEN

EIGENTUM DER CONTINENTAL TEVES AG & CO. OHG

VERTRAULICH

Dieser Informationsträger und die darin enthaltenen Informationen sind Eigentum von Continental Teves AG & Co. oHG (TEVES). Jegliche Vervielfältigung, Offenbarung oder Benutzung dieser Informationen ist ohne vorherige schriftliche Zustimmung von TEVES verboten. TEVES behält sich weltweit alle Rechte auch für den Fall der Erteilung von gewerblichen Schutzrechten vor. Die gleichen Regelungen gelten für diesbezügliche mündliche Mitteilungen entsprechend.





Customer Product Specification
MK25 Safety Concept
TOYOTA 532N ABS/EBD/BTRAC/ETRAC/VSC/HBA

ATE N 655 66.14
Sheet 152
Page 51 of 206

ALLE RECHTE VORBEHALTEN

EIGENTUM DER CONTINENTAL TEVES AG & CO. OHG

VERTRAULICH

Dieser Informationsträger und die darin enthaltenen Informationen sind Eigentum von Continental Teves AG & Co. oHG (TEVES). Jegliche Vervielfältigung, Offenbarung oder Benutzung dieser Informationen ist ohne vorherige schriftliche Zustimmung von TEVES verboten. TEVES behält sich weltweit alle Rechte auch für den Fall der Erteilung von gewerblichen Schutzrechten vor. Die gleichen Regelungen gelten für diesbezügliche mündliche Mitteilungen entsprechend.

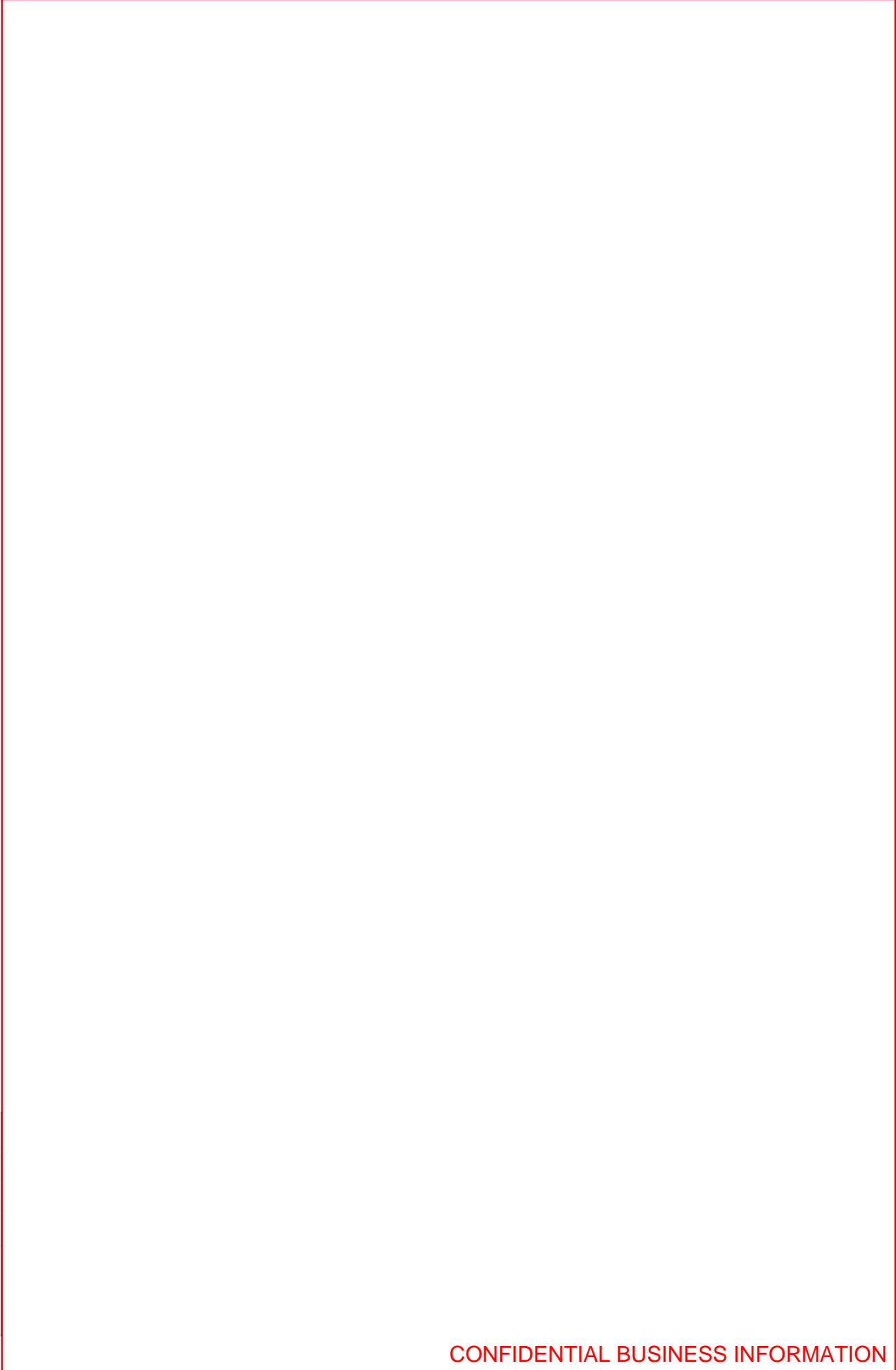

CONFIDENTIAL AND PROPRIETARY
This information carrier and the information it contains are the property of Continental Teves AG & Co. oHG (TEVES). Any reproduction, disclosure or use of either is prohibited without the prior written consent of TEVES. TEVES reserve worldwide all rights also in case of industrial property rights being granted. The same provisions apply to any oral communications related thereto accordingly.

PROPERTY OF CONTINENTAL TEVES AG & CO. OHG
ALL RIGHTS RESERVED



Customer Product Specification
MK25 Safety Concept
TOYOTA 532N ABS/EBD/BTRAC/ETRAC/VSC/HBA

ATE N 655 66.14
Sheet 152
Page 52 of 206

ALLE RECHTE VORBEHALTEN

EIGENTUM DER CONTINENTAL TEVES AG & CO. OHG

VERTRAULICH

Dieser Informationsträger und die darin enthaltenen Informationen sind Eigentum von Continental Teves AG & Co. oHG (TEVES). Jegliche Vervielfältigung, Offenbarung oder Benutzung dieser Informationen ist ohne vorherige schriftliche Zustimmung von TEVES verboten. TEVES behält sich weltweit alle Rechte auch für den Fall der Erteilung von gewerblichen Schutzrechten vor. Die gleichen Regelungen gelten für diesbezügliche mündliche Mitteilungen entsprechend.



CONFIDENTIAL AND PROPRIETARY
This information carrier and the information it contains are the property of Continental Teves AG & Co. oHG (TEVES). Any reproduction, disclosure or use of either is prohibited without the prior written consent of TEVES. TEVES reserve worldwide all rights also in case of industrial property rights being granted. The same provisions apply to any oral communications related thereto accordingly.

PROPERTY OF CONTINENTAL TEVES AG & CO. OHG
ALL RIGHTS RESERVED



Customer Product Specification
MK25 Safety Concept
TOYOTA 532N ABS/EBD/BTRAC/ETRAC/VSC/HBA

ATE N 655 66.14
Sheet 152
Page 53 of 206

ALLE RECHTE VORBEHALTEN

EIGENTUM DER CONTINENTAL TEVES AG & CO. OHG

VERTRAULICH

Dieser Informationsträger und die darin enthaltenen Informationen sind Eigentum von Continental Teves AG & Co. oHG (TEVES). Jegliche Vervielfältigung, Offenbarung oder Benutzung dieser Informationen ist ohne vorherige schriftliche Zustimmung von TEVES verboten. TEVES behält sich weltweit alle Rechte auch für den Fall der Erteilung von gewerblichen Schutzrechten vor. Die gleichen Regelungen gelten für diesbezügliche mündliche Mitteilungen entsprechend.

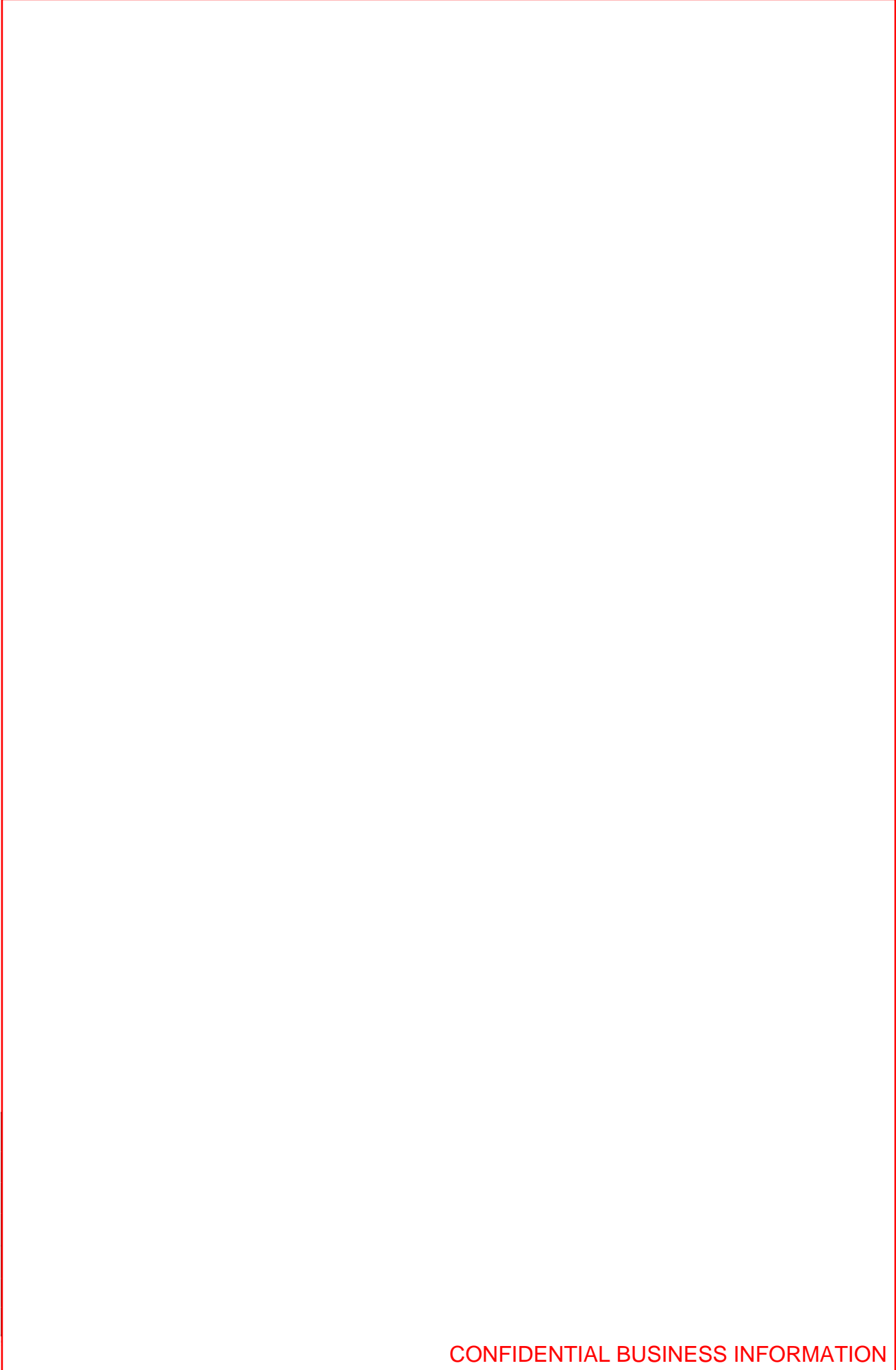

CONFIDENTIAL AND PROPRIETARY
This information carrier and the information it contains are the property of Continental Teves AG & Co. oHG (TEVES). Any reproduction, disclosure or use of either is prohibited without the prior written consent of TEVES. TEVES reserve worldwide all rights also in case of industrial property rights being granted. The same provisions apply to any oral communications related thereto accordingly.

PROPERTY OF CONTINENTAL TEVES AG & CO. OHG
ALL RIGHTS RESERVED



Customer Product Specification
MK25 Safety Concept
TOYOTA 532N ABS/EBD/BTRAC/ETRAC/VSC/HBA

ATE N 655 66.14
Sheet 152
Page 54 of 206

ALLE RECHTE VORBEHALTEN

EIGENTUM DER CONTINENTAL TEVES AG & CO. OHG

VERTRAULICH

Dieser Informationsträger und die darin enthaltenen Informationen sind Eigentum von Continental Teves AG & Co. oHG (TEVES). Jegliche Vervielfältigung, Offenbarung oder Benutzung dieser Informationen ist ohne vorherige schriftliche Zustimmung von TEVES verboten. TEVES behält sich weltweit alle Rechte auch für den Fall der Erteilung von gewerblichen Schutzrechten vor. Die gleichen Regelungen gelten für diesbezügliche mündliche Mitteilungen entsprechend.

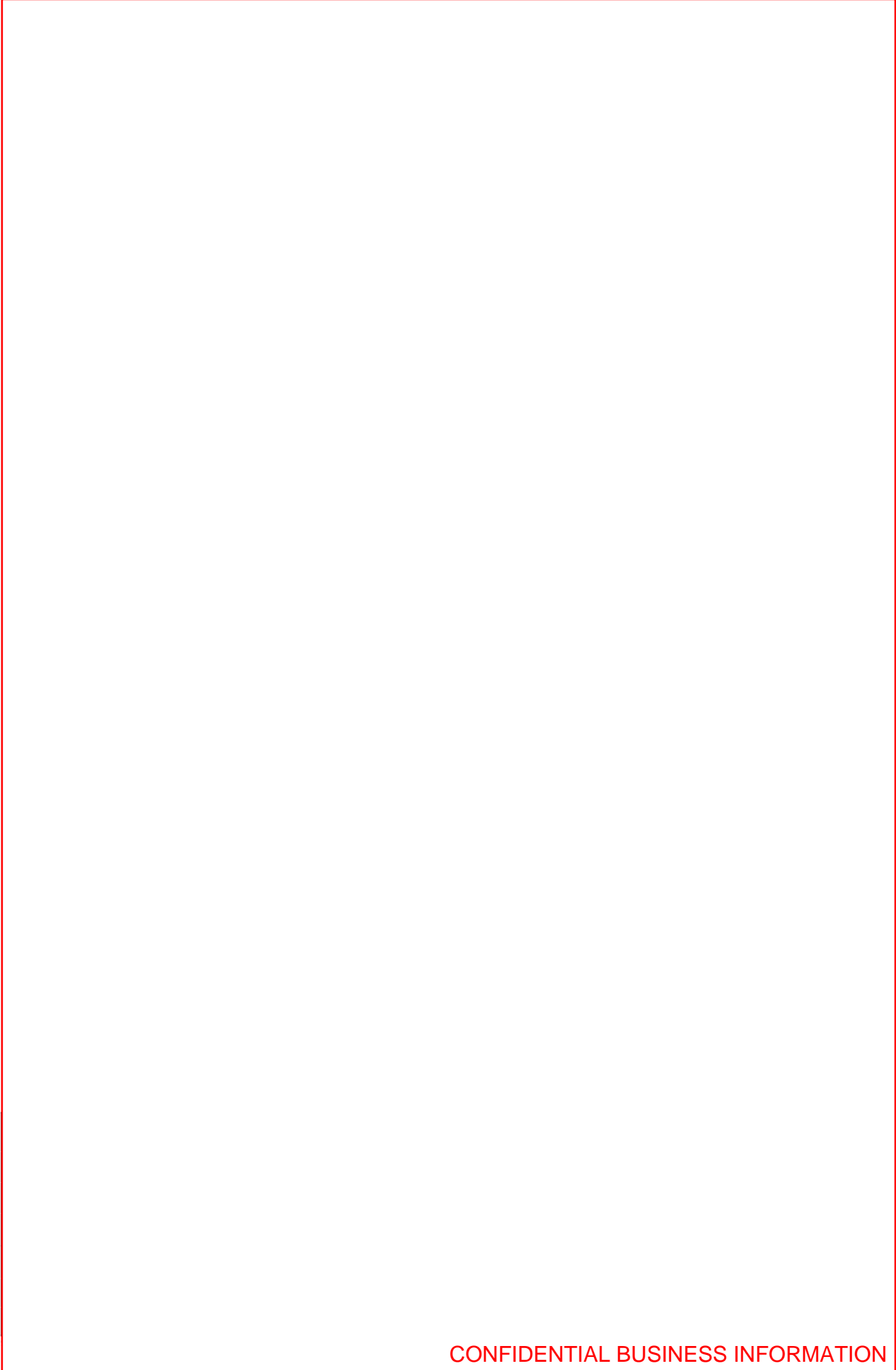

CONFIDENTIAL AND PROPRIETARY
This information carrier and the information it contains are the property of Continental Teves AG & Co. oHG (TEVES). Any reproduction, disclosure or use of either is prohibited without the prior written consent of TEVES. TEVES reserve worldwide all rights also in case of industrial property rights being granted. The same provisions apply to any oral communications related thereto accordingly.

PROPERTY OF CONTINENTAL TEVES AG & CO. OHG
ALL RIGHTS RESERVED



Customer Product Specification
MK25 Safety Concept
TOYOTA 532N ABS/EBD/BTRAC/ETRAC/VSC/HBA

ATE N 655 66.14
Sheet 152
Page 55 of 206

ALLE RECHTE VORBEHALTEN

EIGENTUM DER CONTINENTAL TEVES AG & CO. OHG

VERTRAULICH

Dieser Informationsträger und die darin enthaltenen Informationen sind Eigentum von Continental Teves AG & Co. oHG (TEVES). Jegliche Vervielfältigung, Offenbarung oder Benutzung dieser Informationen ist ohne vorherige schriftliche Zustimmung von TEVES verboten. TEVES behält sich weltweit alle Rechte auch für den Fall der Erteilung von gewerblichen Schutzrechten vor. Die gleichen Regelungen gelten für diesbezügliche mündliche Mitteilungen entsprechend.

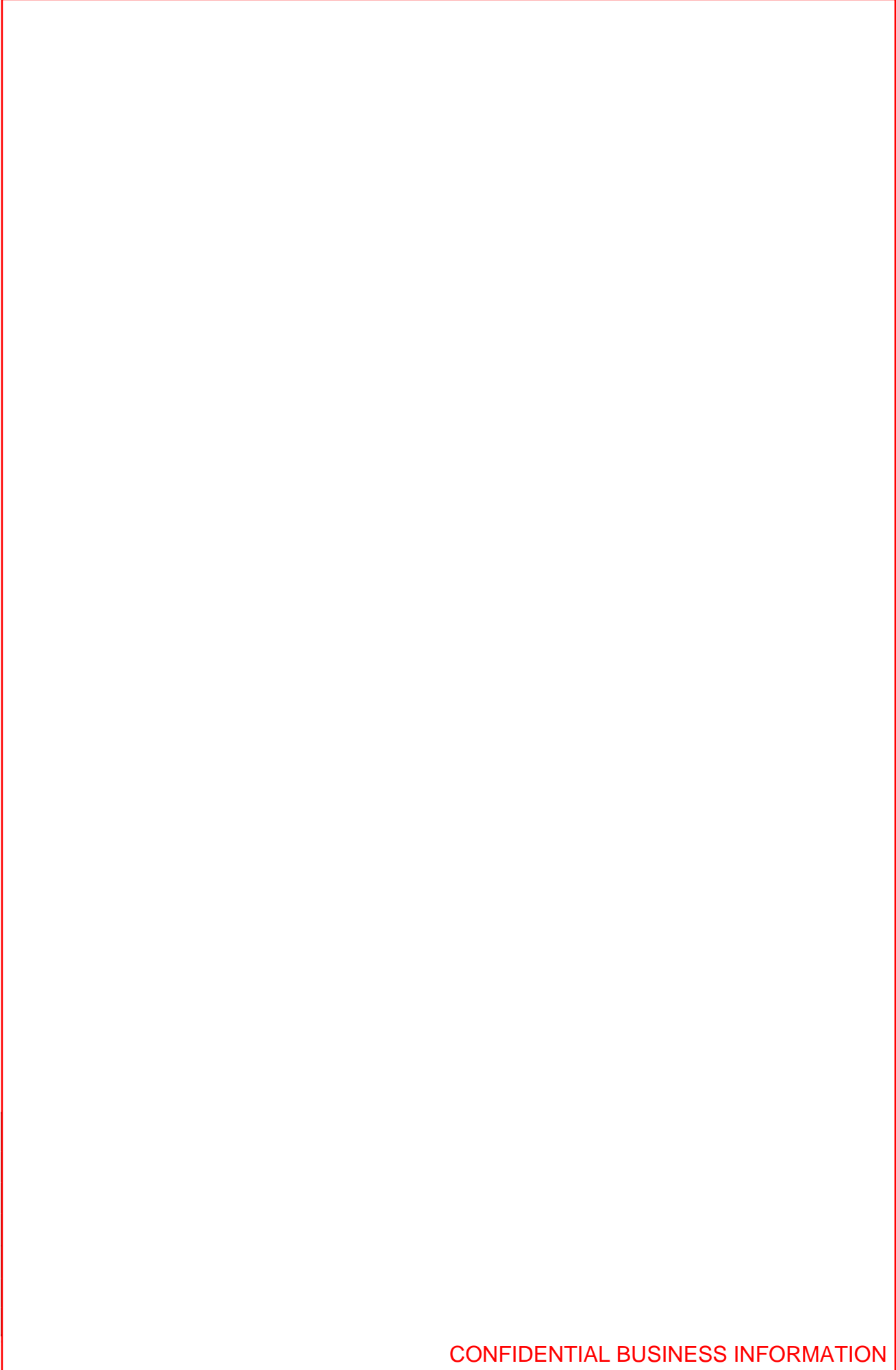

CONFIDENTIAL AND PROPRIETARY
This information carrier and the information it contains are the property of Continental Teves AG & Co. oHG (TEVES). Any reproduction, disclosure or use of either is prohibited without the prior written consent of TEVES. TEVES reserve worldwide all rights also in case of industrial property rights being granted. The same provisions apply to any oral communications related thereto accordingly.

PROPERTY OF CONTINENTAL TEVES AG & CO. OHG
ALL RIGHTS RESERVED



Customer Product Specification
MK25 Safety Concept
TOYOTA 532N ABS/EBD/BTRAC/ETRAC/VSC/HBA

ATE N 655 66.14
Sheet 152
Page 56 of 206

ALLE RECHTE VORBEHALTEN

EIGENTUM DER CONTINENTAL TEVES AG & CO. OHG

VERTRAULICH

Dieser Informationsträger und die darin enthaltenen Informationen sind Eigentum von Continental Teves AG & Co. oHG (TEVES). Jegliche Vervielfältigung, Offenbarung oder Benutzung dieser Informationen ist ohne vorherige schriftliche Zustimmung von TEVES verboten. TEVES behält sich weltweit alle Rechte auch für den Fall der Erteilung von gewerblichen Schutzrechten vor. Die gleichen Regelungen gelten für diesbezügliche mündliche Mitteilungen entsprechend.

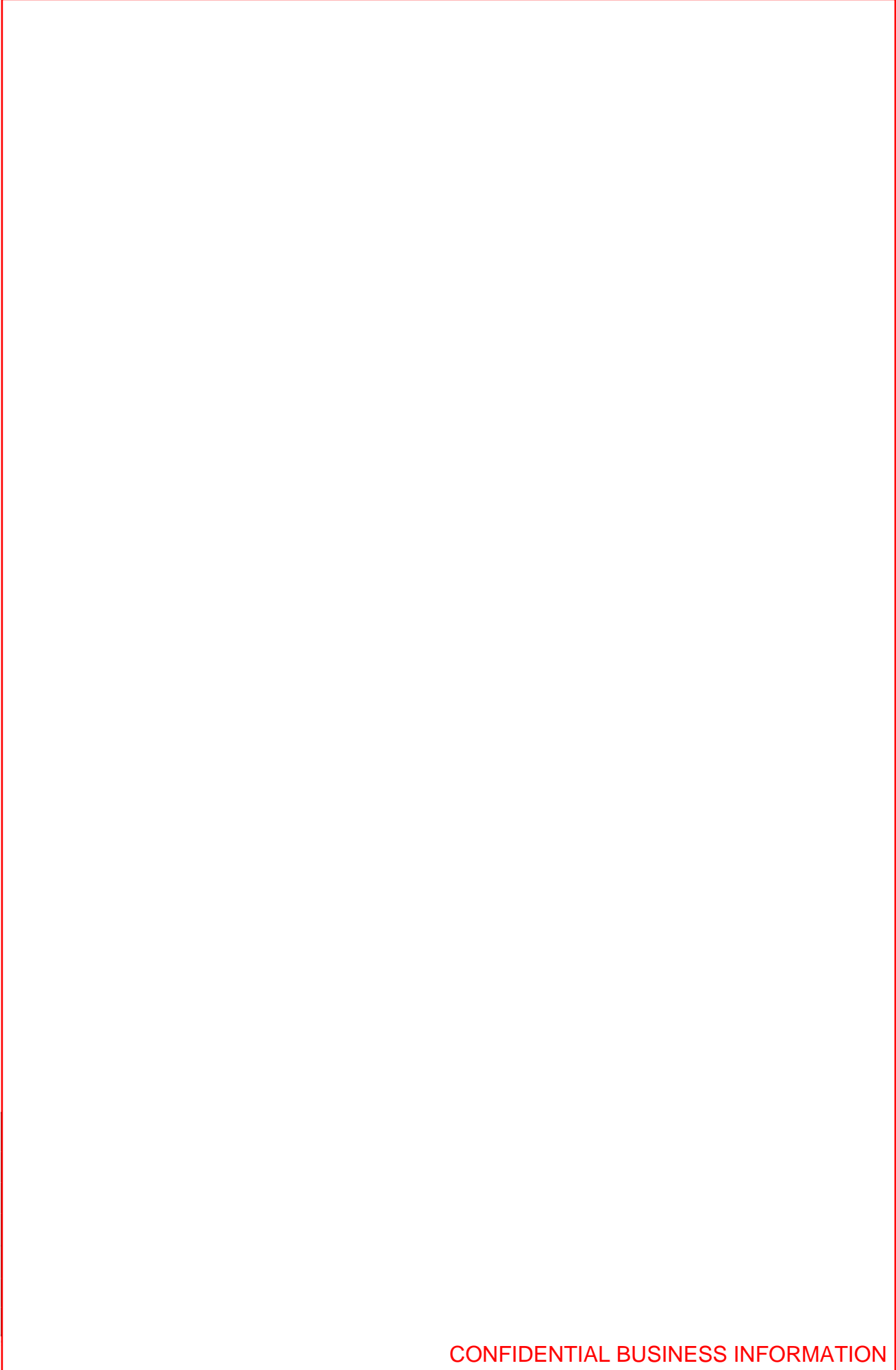

CONFIDENTIAL AND PROPRIETARY
This information carrier and the information it contains are the property of Continental Teves AG & Co. oHG (TEVES). Any reproduction, disclosure or use of either is prohibited without the prior written consent of TEVES. TEVES reserve worldwide all rights also in case of industrial property rights being granted. The same provisions apply to any oral communications related thereto accordingly.

PROPERTY OF CONTINENTAL TEVES AG & CO. OHG
ALL RIGHTS RESERVED



Customer Product Specification
MK25 Safety Concept
TOYOTA 532N ABS/EBD/BTRAC/ETRAC/VSC/HBA

ATE N 655 66.14
Sheet 152
Page 57 of 206

ALLE RECHTE VORBEHALTEN

EIGENTUM DER CONTINENTAL TEVES AG & CO. OHG

VERTRAULICH

Dieser Informationsträger und die darin enthaltenen Informationen sind Eigentum von Continental Teves AG & Co. oHG (TEVES). Jegliche Vervielfältigung, Offenbarung oder Benutzung dieser Informationen ist ohne vorherige schriftliche Zustimmung von TEVES verboten. TEVES behält sich weltweit alle Rechte auch für den Fall der Erteilung von gewerblichen Schutzrechten vor. Die gleichen Regelungen gelten für diesbezügliche mündliche Mitteilungen entsprechend.

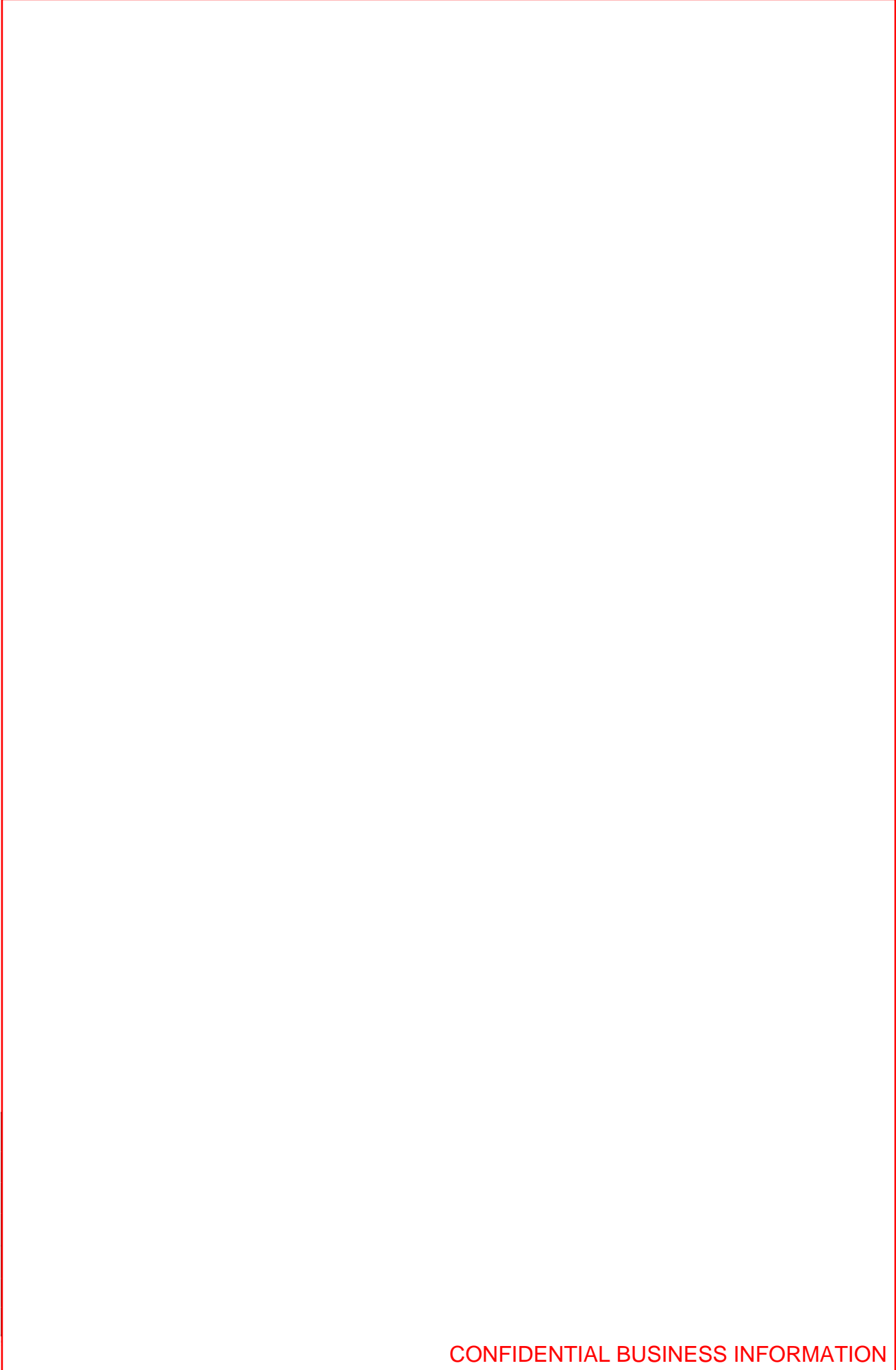

CONFIDENTIAL AND PROPRIETARY
This information carrier and the information it contains are the property of Continental Teves AG & Co. oHG (TEVES). Any reproduction, disclosure or use of either is prohibited without the prior written consent of TEVES. TEVES reserve worldwide all rights also in case of industrial property rights being granted. The same provisions apply to any oral communications related thereto accordingly.

PROPERTY OF CONTINENTAL TEVES AG & CO. OHG
ALL RIGHTS RESERVED



Customer Product Specification
MK25 Safety Concept
TOYOTA 532N ABS/EBD/BTRAC/ETRAC/VSC/HBA

ATE N 655 66.14
Sheet 152
Page 58 of 206

ALLE RECHTE VORBEHALTEN

EIGENTUM DER CONTINENTAL TEVES AG & CO. OHG

VERTRAULICH

Dieser Informationsträger und die darin enthaltenen Informationen sind Eigentum von Continental Teves AG & Co. oHG (TEVES). Jegliche Vervielfältigung, Offenbarung oder Benutzung dieser Informationen ist ohne vorherige schriftliche Zustimmung von TEVES verboten. TEVES behält sich weltweit alle Rechte auch für den Fall der Erteilung von gewerblichen Schutzrechten vor. Die gleichen Regelungen gelten für diesbezügliche mündliche Mitteilungen entsprechend.



CONFIDENTIAL AND PROPRIETARY
This information carrier and the information it contains are the property of Continental Teves AG & Co. oHG (TEVES). Any reproduction, disclosure or use of either is prohibited without the prior written consent of TEVES. TEVES reserve worldwide all rights also in case of industrial property rights being granted. The same provisions apply to any oral communications related thereto accordingly.

PROPERTY OF CONTINENTAL TEVES AG & CO. OHG
ALL RIGHTS RESERVED



Customer Product Specification
MK25 Safety Concept
TOYOTA 532N ABS/EBD/BTRAC/ETRAC/VSC/HBA

ATE N 655 66.14
Sheet 152
Page 59 of 206

ALLE RECHTE VORBEHALTEN

EIGENTUM DER CONTINENTAL TEVES AG & CO. OHG

VERTRAULICH

Dieser Informationsträger und die darin enthaltenen Informationen sind Eigentum von Continental Teves AG & Co. oHG (TEVES). Jegliche Vervielfältigung, Offenbarung oder Benutzung dieser Informationen ist ohne vorherige schriftliche Zustimmung von TEVES verboten. TEVES behält sich weltweit alle Rechte auch für den Fall der Erteilung von gewerblichen Schutzrechten vor. Die gleichen Regelungen gelten für diesbezügliche mündliche Mitteilungen entsprechend.

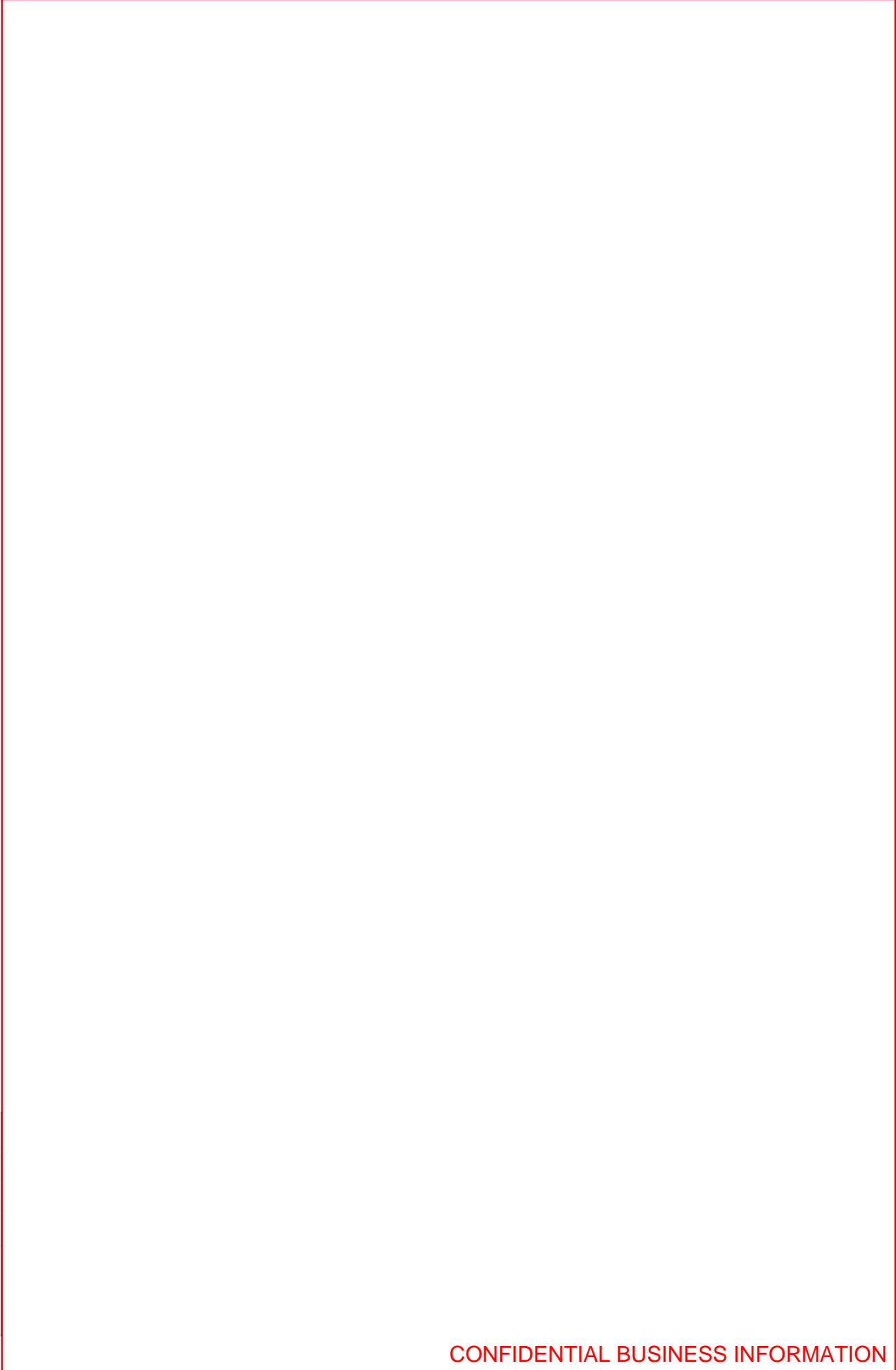

CONFIDENTIAL AND PROPRIETARY
This information carrier and the information it contains are the property of Continental Teves AG & Co. oHG (TEVES). Any reproduction, disclosure or use of either is prohibited without the prior written consent of TEVES. TEVES reserve worldwide all rights also in case of industrial property rights being granted. The same provisions apply to any oral communications related thereto accordingly.

PROPERTY OF CONTINENTAL TEVES AG & CO. OHG
ALL RIGHTS RESERVED



Customer Product Specification
MK25 Safety Concept
TOYOTA 532N ABS/EBD/BTRAC/ETRAC/VSC/HBA

ATE N 655 66.14
Sheet 152
Page 60 of 206

ALLE RECHTE VORBEHALTEN

EIGENTUM DER CONTINENTAL TEVES AG & CO. OHG

VERTRAULICH

Dieser Informationsträger und die darin enthaltenen Informationen sind Eigentum von Continental Teves AG & Co. oHG (TEVES). Jegliche Vervielfältigung, Offenbarung oder Benutzung dieser Informationen ist ohne vorherige schriftliche Zustimmung von TEVES verboten. TEVES behält sich weltweit alle Rechte auch für den Fall der Erteilung von gewerblichen Schutzrechten vor. Die gleichen Regelungen gelten für diesbezügliche mündliche Mitteilungen entsprechend.



CONFIDENTIAL AND PROPRIETARY
This information carrier and the information it contains are the property of Continental Teves AG & Co. oHG (TEVES). Any reproduction, disclosure or use of either is prohibited without the prior written consent of TEVES. TEVES reserve worldwide all rights also in case of industrial property rights being granted. The same provisions apply to any oral communications related thereto accordingly.

PROPERTY OF CONTINENTAL TEVES AG & CO. OHG
ALL RIGHTS RESERVED



Customer Product Specification
MK25 Safety Concept
TOYOTA 532N ABS/EBD/BTRAC/ETRAC/VSC/HBA

ATE N 655 66.14
Sheet 152
Page 61 of 206

ALLE RECHTE VORBEHALTEN

EIGENTUM DER CONTINENTAL TEVES AG & CO. OHG

VERTRAULICH

Dieser Informationsträger und die darin enthaltenen Informationen sind Eigentum von Continental Teves AG & Co. oHG (TEVES). Jegliche Vervielfältigung, Offenbarung oder Benutzung dieser Informationen ist ohne vorherige schriftliche Zustimmung von TEVES verboten. TEVES behält sich weltweit alle Rechte auch für den Fall der Erteilung von gewerblichen Schutzrechten vor. Die gleichen Regelungen gelten für diesbezügliche mündliche Mitteilungen entsprechend.

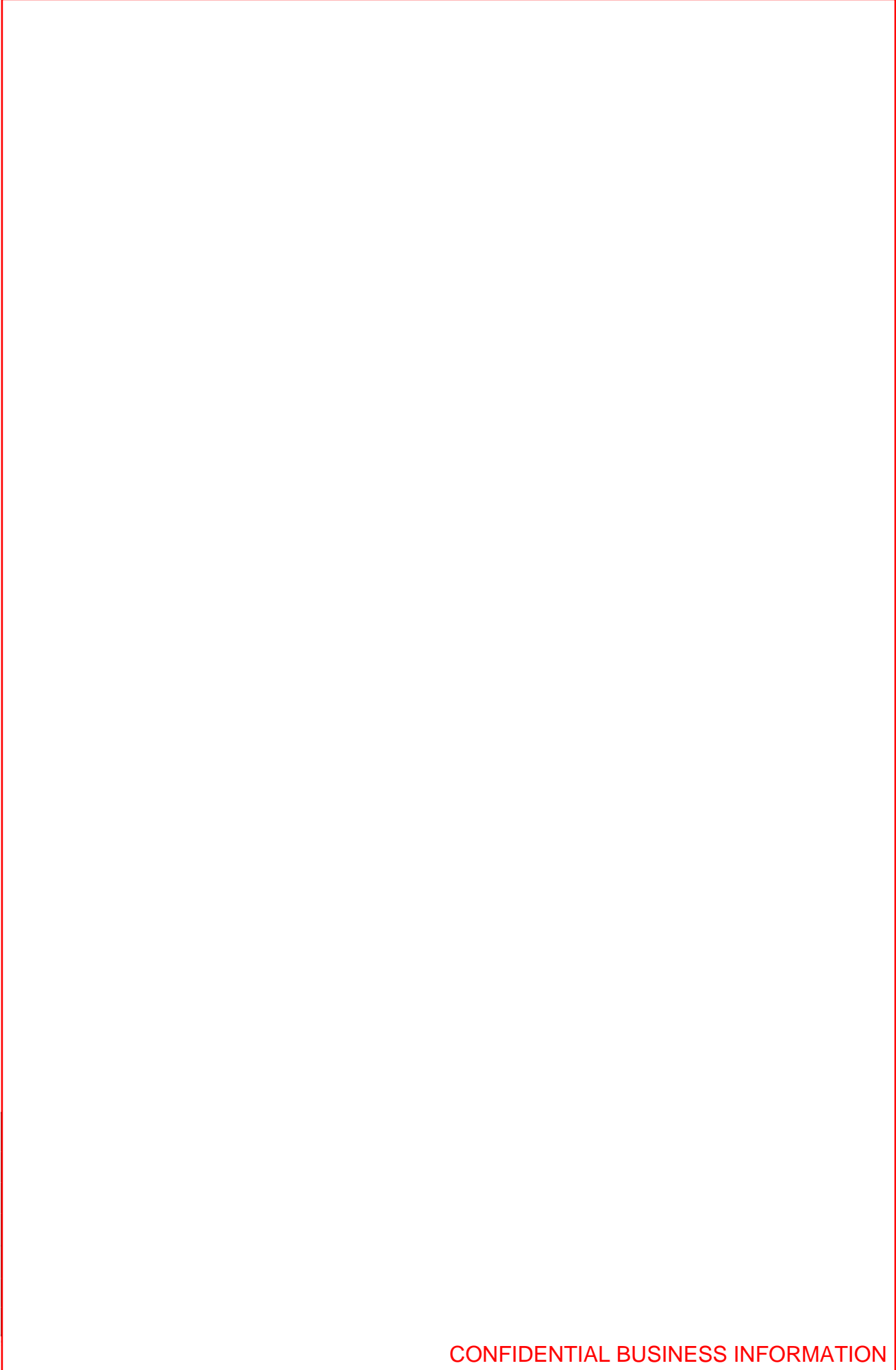

CONFIDENTIAL AND PROPRIETARY
This information carrier and the information it contains are the property of Continental Teves AG & Co. oHG (TEVES). Any reproduction, disclosure or use of either is prohibited without the prior written consent of TEVES. TEVES reserve worldwide all rights also in case of industrial property rights being granted. The same provisions apply to any oral communications related thereto accordingly.

PROPERTY OF CONTINENTAL TEVES AG & CO. OHG
ALL RIGHTS RESERVED



Customer Product Specification
MK25 Safety Concept
TOYOTA 532N ABS/EBD/BTRAC/ETRAC/VSC/HBA

ATE N 655 66.14
Sheet 152
Page 62 of 206

ALLE RECHTE VORBEHALTEN

EIGENTUM DER CONTINENTAL TEVES AG & CO. OHG

VERTRAULICH

Dieser Informationsträger und die darin enthaltenen Informationen sind Eigentum von Continental Teves AG & Co. oHG (TEVES). Jegliche Vervielfältigung, Offenbarung oder Benutzung dieser Informationen ist ohne vorherige schriftliche Zustimmung von TEVES verboten. TEVES behält sich weltweit alle Rechte auch für den Fall der Erteilung von gewerblichen Schutzrechten vor. Die gleichen Regelungen gelten für diesbezügliche mündliche Mitteilungen entsprechend.



CONFIDENTIAL AND PROPRIETARY
This information carrier and the information it contains are the property of Continental Teves AG & Co. oHG (TEVES). Any reproduction, disclosure or use of either is prohibited without the prior written consent of TEVES. TEVES reserve worldwide all rights also in case of industrial property rights being granted. The same provisions apply to any oral communications related thereto accordingly.

PROPERTY OF CONTINENTAL TEVES AG & CO. OHG
ALL RIGHTS RESERVED



Customer Product Specification
MK25 Safety Concept
TOYOTA 532N ABS/EBD/BTRAC/ETRAC/VSC/HBA

ATE N 655 66.14
Sheet 152
Page 63 of 206

ALLE RECHTE VORBEHALTEN

EIGENTUM DER CONTINENTAL TEVES AG & CO. OHG

VERTRAULICH

Dieser Informationsträger und die darin enthaltenen Informationen sind Eigentum von Continental Teves AG & Co. oHG (TEVES). Jegliche Vervielfältigung, Offenbarung oder Benutzung dieser Informationen ist ohne vorherige schriftliche Zustimmung von TEVES verboten. TEVES behält sich weltweit alle Rechte auch für den Fall der Erteilung von gewerblichen Schutzrechten vor. Die gleichen Regelungen gelten für diesbezügliche mündliche Mitteilungen entsprechend.



CONFIDENTIAL AND PROPRIETARY
This information carrier and the information it contains are the property of Continental Teves AG & Co. oHG (TEVES). Any reproduction, disclosure or use of either is prohibited without the prior written consent of TEVES. TEVES reserve worldwide all rights also in case of industrial property rights being granted. The same provisions apply to any oral communications related thereto accordingly.

PROPERTY OF CONTINENTAL TEVES AG & CO. OHG
ALL RIGHTS RESERVED



Customer Product Specification
MK25 Safety Concept
TOYOTA 532N ABS/EBD/BTRAC/ETRAC/VSC/HBA

ATE N 655 66.14
Sheet 152
Page 64 of 206

ALLE RECHTE VORBEHALTEN

EIGENTUM DER CONTINENTAL TEVES AG & CO. OHG

VERTRAULICH

Dieser Informationsträger und die darin enthaltenen Informationen sind Eigentum von Continental Teves AG & Co. oHG (TEVES). Jegliche Vervielfältigung, Offenbarung oder Benutzung dieser Informationen ist ohne vorherige schriftliche Zustimmung von TEVES verboten. TEVES behält sich weltweit alle Rechte auch für den Fall der Erteilung von gewerblichen Schutzrechten vor. Die gleichen Regelungen gelten für diesbezügliche mündliche Mitteilungen entsprechend.

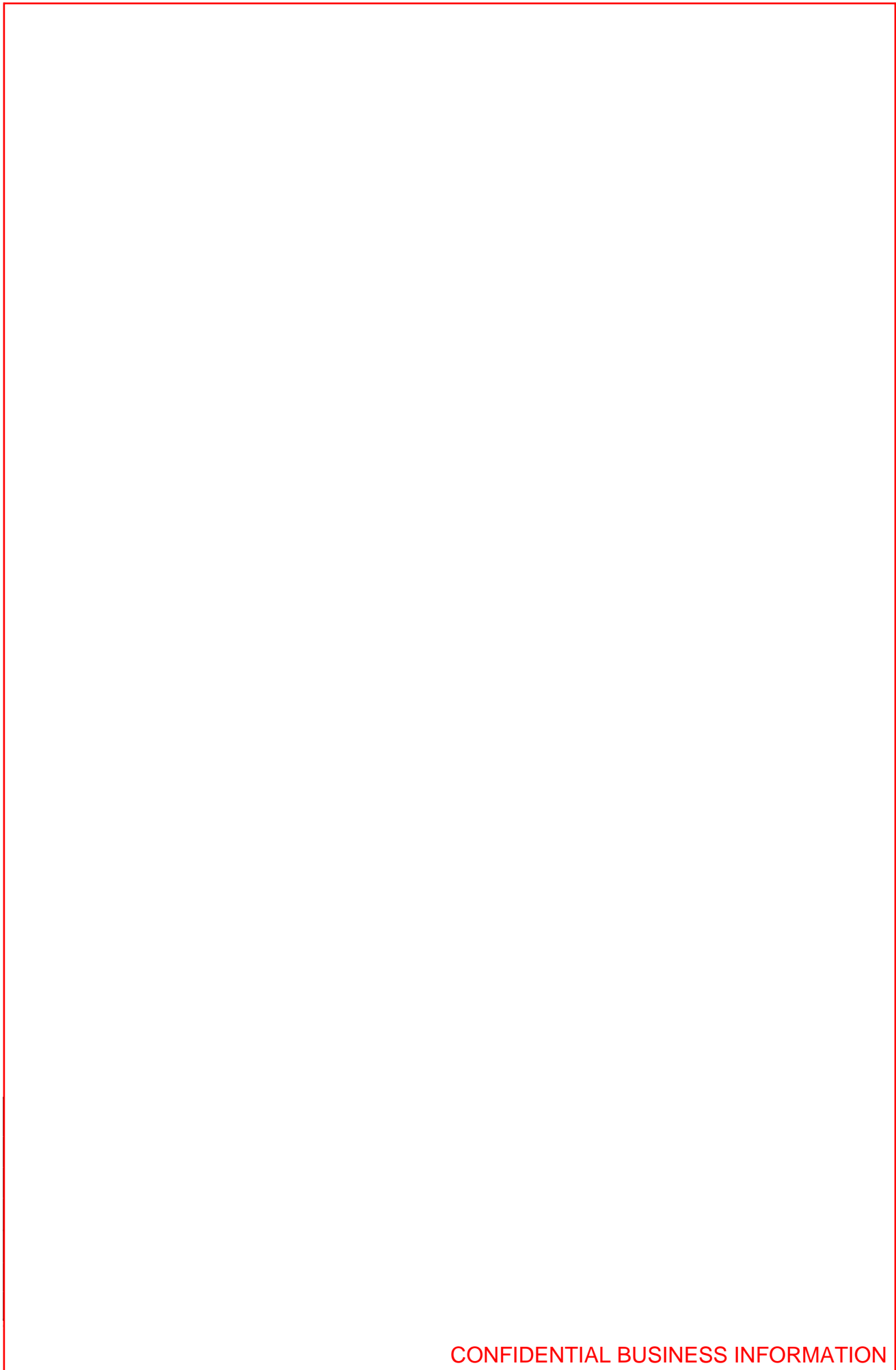

CONFIDENTIAL AND PROPRIETARY
This information carrier and the information it contains are the property of Continental Teves AG & Co. oHG (TEVES). Any reproduction, disclosure or use of either is prohibited without the prior written consent of TEVES. TEVES reserve worldwide all rights also in case of industrial property rights being granted. The same provisions apply to any oral communications related thereto accordingly.

PROPERTY OF CONTINENTAL TEVES AG & CO. OHG
ALL RIGHTS RESERVED



Customer Product Specification
MK25 Safety Concept
TOYOTA 532N ABS/EBD/BTRAC/ETRAC/VSC/HBA

ATE N 655 66.14
Sheet 152
Page 65 of 206

ALLE RECHTE VORBEHALTEN

EIGENTUM DER CONTINENTAL TEVES AG & CO. OHG

VERTRAULICH

Dieser Informationsträger und die darin enthaltenen Informationen sind Eigentum von Continental Teves AG & Co. oHG (TEVES). Jegliche Vervielfältigung, Offenbarung oder Benutzung dieser Informationen ist ohne vorherige schriftliche Zustimmung von TEVES verboten. TEVES behält sich weltweit alle Rechte auch für den Fall der Erteilung von gewerblichen Schutzrechten vor. Die gleichen Regelungen gelten für diesbezügliche mündliche Mitteilungen entsprechend.



CONFIDENTIAL AND PROPRIETARY
This information carrier and the information it contains are the property of Continental Teves AG & Co. oHG (TEVES). Any reproduction, disclosure or use of either is prohibited without the prior written consent of TEVES. TEVES reserve worldwide all rights also in case of industrial property rights being granted. The same provisions apply to any oral communications related thereto accordingly.

PROPERTY OF CONTINENTAL TEVES AG & CO. OHG
ALL RIGHTS RESERVED



Customer Product Specification
MK25 Safety Concept
TOYOTA 532N ABS/EBD/BTRAC/ETRAC/VSC/HBA

ATE N 655 66.14
Sheet 152
Page 66 of 206

ALLE RECHTE VORBEHALTEN

EIGENTUM DER CONTINENTAL TEVES AG & CO. OHG

VERTRAULICH

Dieser Informationsträger und die darin enthaltenen Informationen sind Eigentum von Continental Teves AG & Co. oHG (TEVES). Jegliche Vervielfältigung, Offenbarung oder Benutzung dieser Informationen ist ohne vorherige schriftliche Zustimmung von TEVES verboten. TEVES behält sich weltweit alle Rechte auch für den Fall der Erteilung von gewerblichen Schutzrechten vor. Die gleichen Regelungen gelten für diesbezügliche mündliche Mitteilungen entsprechend.

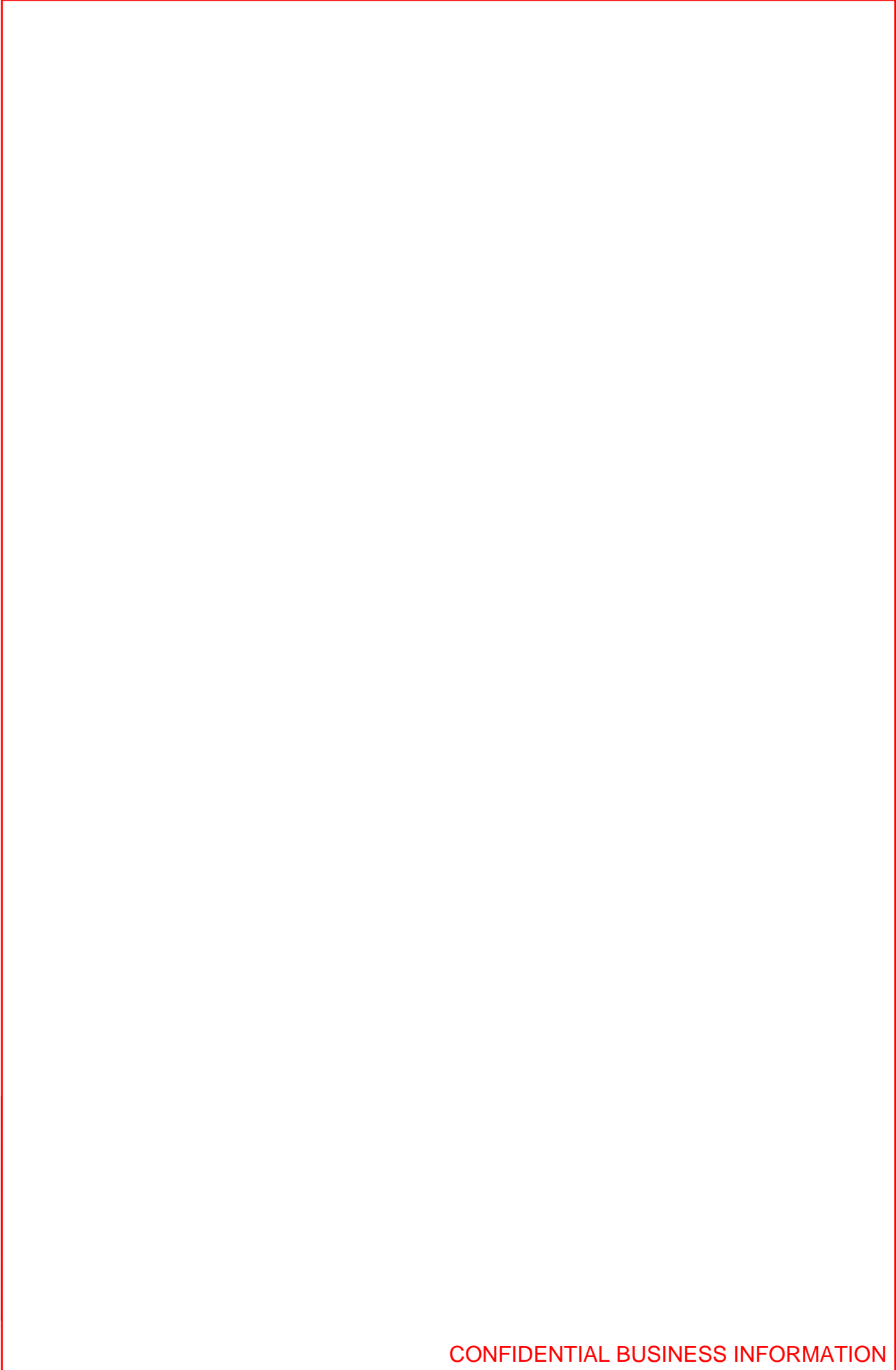

CONFIDENTIAL AND PROPRIETARY
This information carrier and the information it contains are the property of Continental Teves AG & Co. oHG (TEVES). Any reproduction, disclosure or use of either is prohibited without the prior written consent of TEVES. TEVES reserve worldwide all rights also in case of industrial property rights being granted. The same provisions apply to any oral communications related thereto accordingly.



Customer Product Specification
MK25 Safety Concept
TOYOTA 532N ABS/EBD/BTRAC/ETRAC/VSC/HBA

ATE N 655 66.14
Sheet 152
Page 67 of 206

ALLE RECHTE VORBEHALTEN

EIGENTUM DER CONTINENTAL TEVES AG & CO. OHG

VERTRAULICH

Dieser Informationsträger und die darin enthaltenen Informationen sind Eigentum von Continental Teves AG & Co. oHG (TEVES). Jegliche Vervielfältigung, Offenbarung oder Benutzung dieser Informationen ist ohne vorherige schriftliche Zustimmung von TEVES verboten. TEVES behält sich weltweit alle Rechte auch für den Fall der Erteilung von gewerblichen Schutzrechten vor. Die gleichen Regelungen gelten für diesbezügliche mündliche Mitteilungen entsprechend.

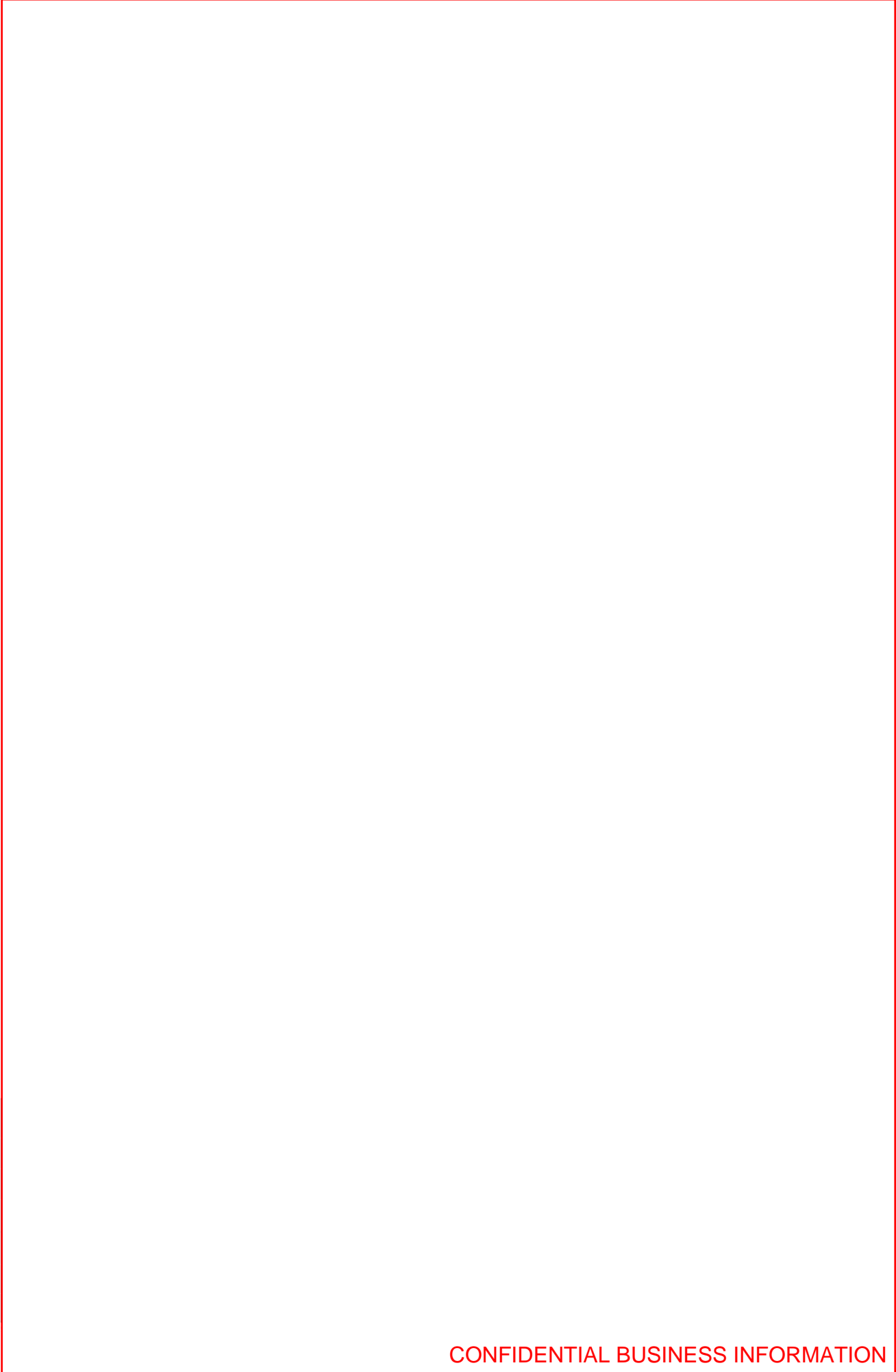

CONFIDENTIAL AND PROPRIETARY
This information carrier and the information it contains are the property of Continental Teves AG & Co. oHG (TEVES). Any reproduction, disclosure or use of either is prohibited without the prior written consent of TEVES. TEVES reserve worldwide all rights also in case of industrial property rights being granted. The same provisions apply to any oral communications related thereto accordingly.

PROPERTY OF CONTINENTAL TEVES AG & CO. OHG
ALL RIGHTS RESERVED



Customer Product Specification
MK25 Safety Concept
TOYOTA 532N ABS/EBD/BTRAC/ETRAC/VSC/HBA

ATE N 655 66.14
Sheet 152
Page 68 of 206

ALLE RECHTE VORBEHALTEN

EIGENTUM DER CONTINENTAL TEVES AG & CO. OHG

VERTRAULICH

Dieser Informationsträger und die darin enthaltenen Informationen sind Eigentum von Continental Teves AG & Co. oHG (TEVES). Jegliche Vervielfältigung, Offenbarung oder Benutzung dieser Informationen ist ohne vorherige schriftliche Zustimmung von TEVES verboten. TEVES behält sich weltweit alle Rechte auch für den Fall der Erteilung von gewerblichen Schutzrechten vor. Die gleichen Regelungen gelten für diesbezügliche mündliche Mitteilungen entsprechend.



CONFIDENTIAL AND PROPRIETARY
This information carrier and the information it contains are the property of Continental Teves AG & Co. oHG (TEVES). Any reproduction, disclosure or use of either is prohibited without the prior written consent of TEVES. TEVES reserve worldwide all rights also in case of industrial property rights being granted. The same provisions apply to any oral communications related thereto accordingly.

PROPERTY OF CONTINENTAL TEVES AG & CO. OHG
ALL RIGHTS RESERVED



Customer Product Specification
MK25 Safety Concept
TOYOTA 532N ABS/EBD/BTRAC/ETRAC/VSC/HBA

ATE N 655 66.14
Sheet 152
Page 70 of 206

ALLE RECHTE VORBEHALTEN

EIGENTUM DER CONTINENTAL TEVES AG & CO. OHG

VERTRAULICH

Dieser Informationsträger und die darin enthaltenen Informationen sind Eigentum von Continental Teves AG & Co. oHG (TEVES). Jegliche Vervielfältigung, Offenbarung oder Benutzung dieser Informationen ist ohne vorherige schriftliche Zustimmung von TEVES verboten. TEVES behält sich weltweit alle Rechte auch für den Fall der Erteilung von gewerblichen Schutzrechten vor. Die gleichen Regelungen gelten für diesbezügliche mündliche Mitteilungen entsprechend.

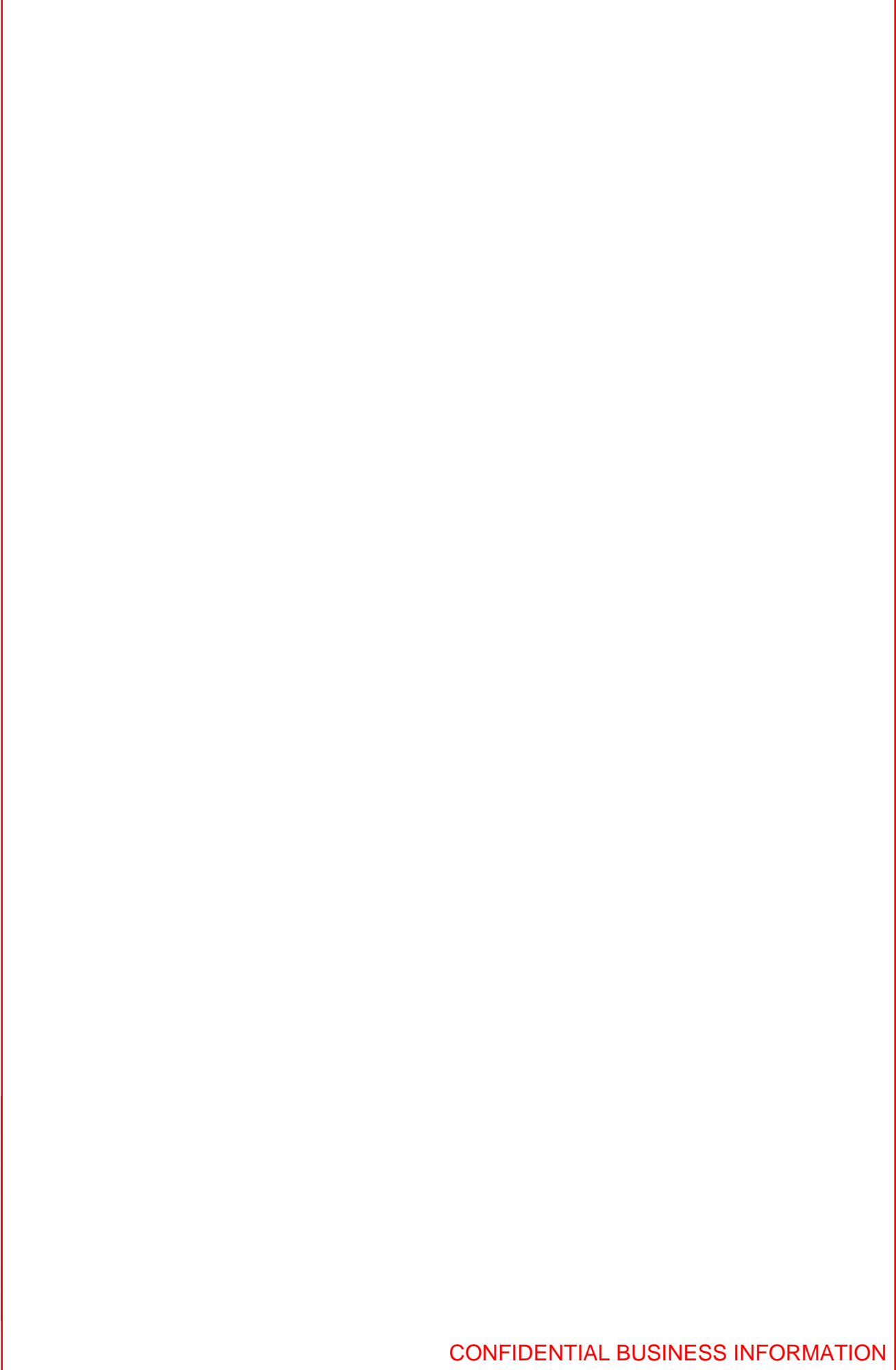

CONFIDENTIAL AND PROPRIETARY
This information carrier and the information it contains are the property of Continental Teves AG & Co. oHG (TEVES). Any reproduction, disclosure or use of either is prohibited without the prior written consent of TEVES. TEVES reserve worldwide all rights also in case of industrial property rights being granted. The same provisions apply to any oral communications related thereto accordingly.

PROPERTY OF CONTINENTAL TEVES AG & CO. OHG
ALL RIGHTS RESERVED



Customer Product Specification
MK25 Safety Concept
TOYOTA 532N ABS/EBD/BTRAC/ETRAC/VSC/HBA

ATE N 655 66.14
Sheet 152
Page 71 of 206

ALLE RECHTE VORBEHALTEN

EIGENTUM DER CONTINENTAL TEVES AG & CO. OHG

VERTRAULICH

Dieser Informationsträger und die darin enthaltenen Informationen sind Eigentum von Continental Teves AG & Co. oHG (TEVES). Jegliche Vervielfältigung, Offenbarung oder Benutzung dieser Informationen ist ohne vorherige schriftliche Zustimmung von TEVES verboten. TEVES behält sich weltweit alle Rechte auch für den Fall der Erteilung von gewerblichen Schutzrechten vor. Die gleichen Regelungen gelten für diesbezügliche mündliche Mitteilungen entsprechend.

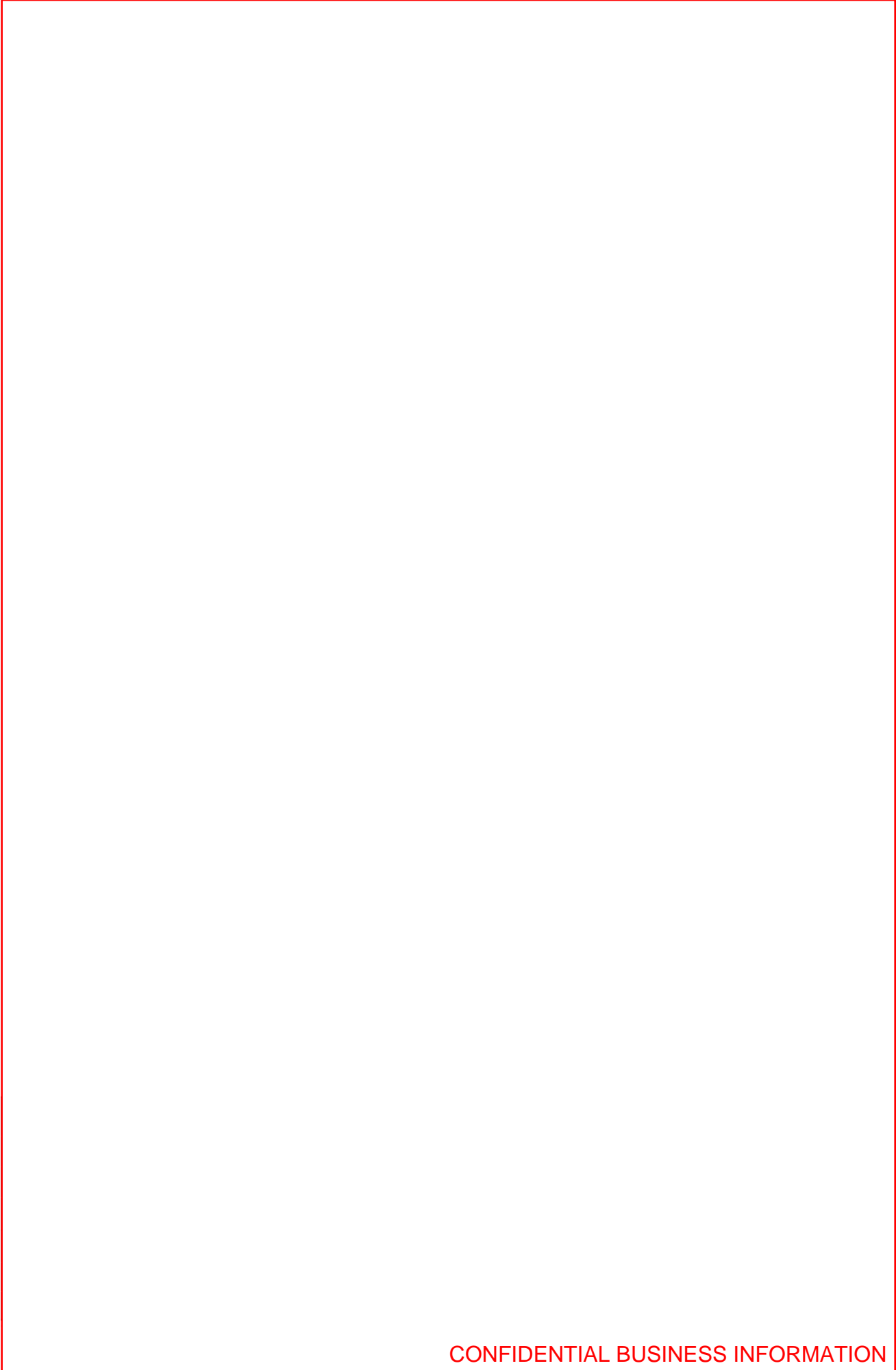



Customer Product Specification
MK25 Safety Concept
TOYOTA 532N ABS/EBD/BTRAC/ETRAC/VSC/HBA

ATE N 655 66.14
Sheet 152
Page 72 of 206

ALLE RECHTE VORBEHALTEN

EIGENTUM DER CONTINENTAL TEVES AG & CO. OHG

VERTRAULICH

Dieser Informationsträger und die darin enthaltenen Informationen sind Eigentum von Continental Teves AG & Co. oHG (TEVES). Jegliche Vervielfältigung, Offenbarung oder Benutzung dieser Informationen ist ohne vorherige schriftliche Zustimmung von TEVES verboten. TEVES behält sich weltweit alle Rechte auch für den Fall der Erteilung von gewerblichen Schutzrechten vor. Die gleichen Regelungen gelten für diesbezügliche mündliche Mitteilungen entsprechend.

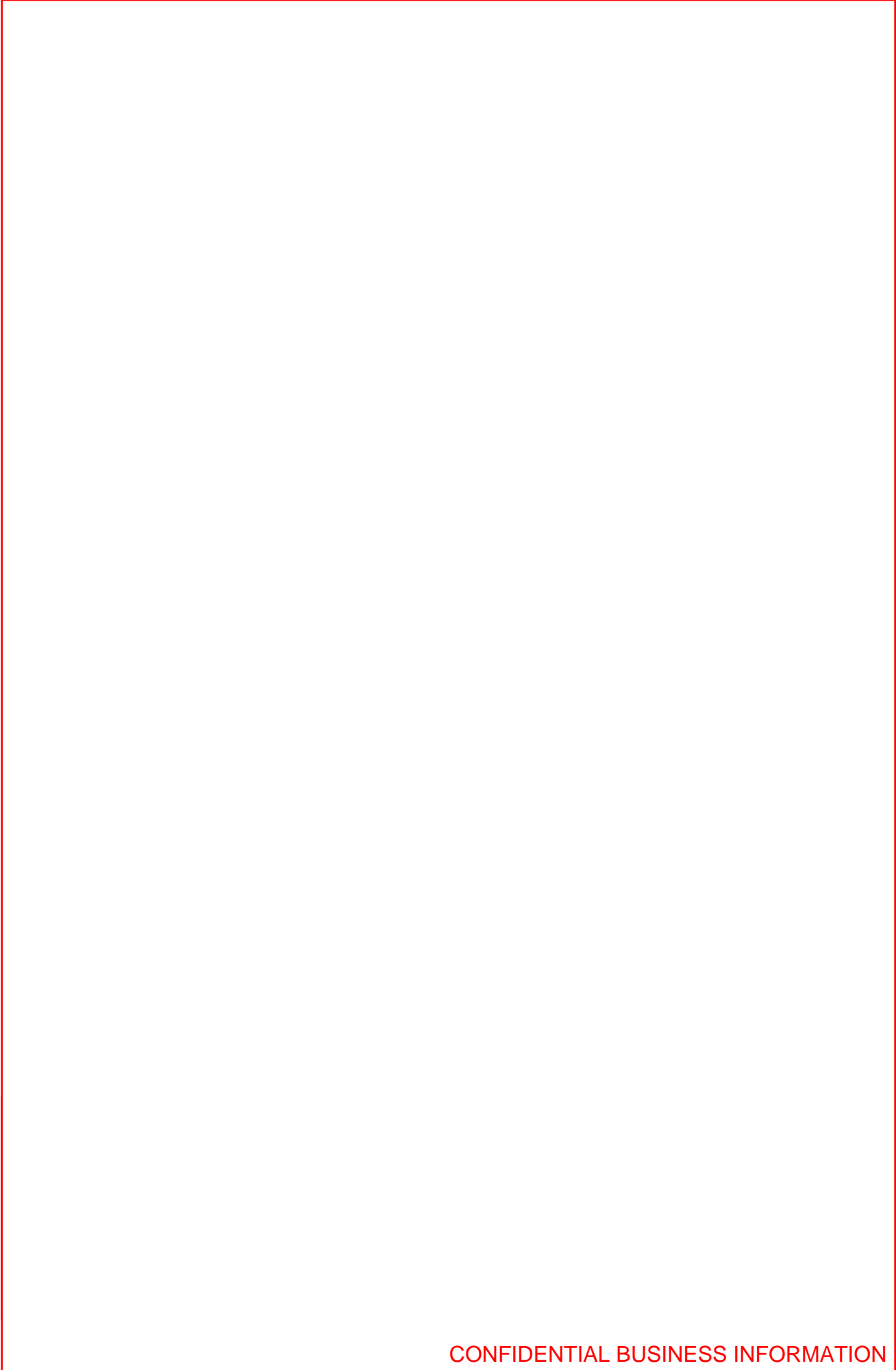

CONFIDENTIAL AND PROPRIETARY
This information carrier and the information it contains are the property of Continental Teves AG & Co. oHG (TEVES). Any reproduction, disclosure or use of either is prohibited without the prior written consent of TEVES. TEVES reserve worldwide all rights also in case of industrial property rights being granted. The same provisions apply to any oral communications related thereto accordingly.



Customer Product Specification
MK25 Safety Concept
TOYOTA 532N ABS/EBD/BTRAC/ETRAC/VSC/HBA

ATE N 655 66.14
Sheet 152
Page 73 of 206

ALLE RECHTE VORBEHALTEN

EIGENTUM DER CONTINENTAL TEVES AG & CO. OHG

VERTRAULICH

Dieser Informationsträger und die darin enthaltenen Informationen sind Eigentum von Continental Teves AG & Co. oHG (TEVES). Jegliche Vervielfältigung, Offenbarung oder Benutzung dieser Informationen ist ohne vorherige schriftliche Zustimmung von TEVES verboten. TEVES behält sich weltweit alle Rechte auch für den Fall der Erteilung von gewerblichen Schutzrechten vor. Die gleichen Regelungen gelten für diesbezügliche mündliche Mitteilungen entsprechend.

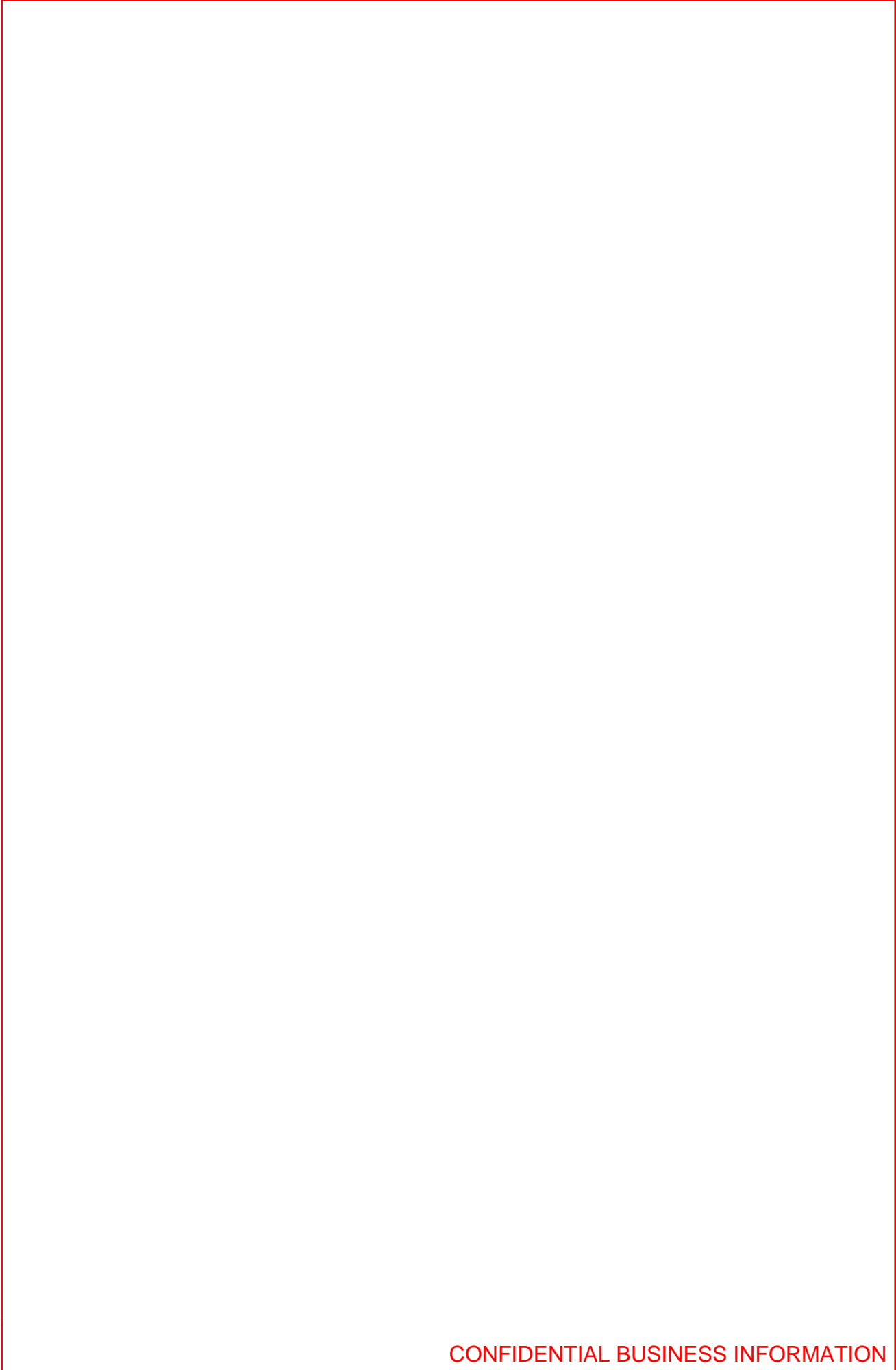



Customer Product Specification
MK25 Safety Concept
TOYOTA 532N ABS/EBD/BTRAC/ETRAC/VSC/HBA

ATE N 655 66.14
Sheet 152
Page 74 of 206

ALLE RECHTE VORBEHALTEN

EIGENTUM DER CONTINENTAL TEVES AG & CO. OHG

VERTRAULICH

Dieser Informationsträger und die darin enthaltenen Informationen sind Eigentum von Continental Teves AG & Co. oHG (TEVES). Jegliche Vervielfältigung, Offenbarung oder Benutzung dieser Informationen ist ohne vorherige schriftliche Zustimmung von TEVES verboten. TEVES behält sich weltweit alle Rechte auch für den Fall der Erteilung von gewerblichen Schutzrechten vor. Die gleichen Regelungen gelten für diesbezügliche mündliche Mitteilungen entsprechend.

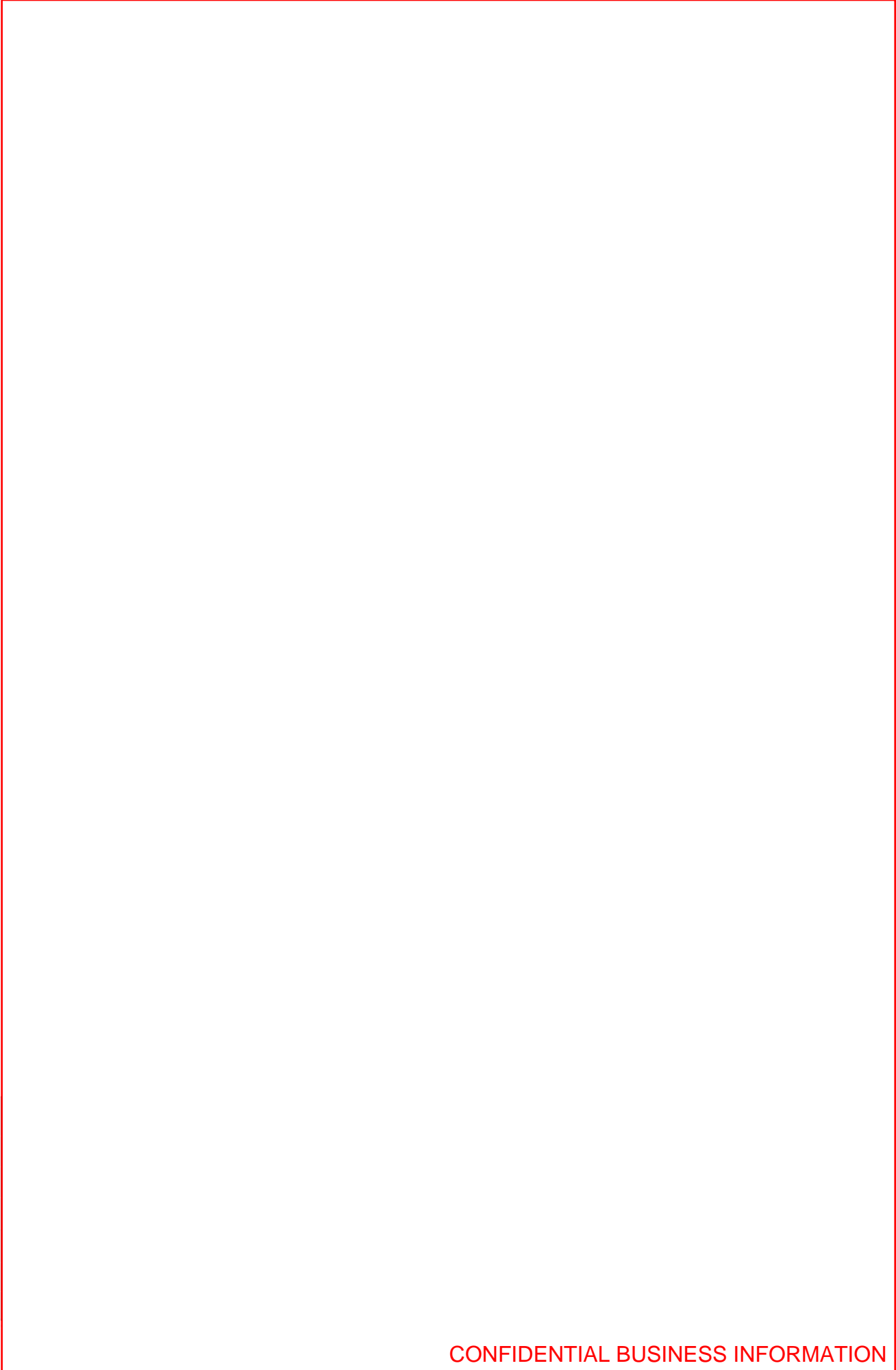

CONFIDENTIAL AND PROPRIETARY
This information carrier and the information it contains are the property of Continental Teves AG & Co. oHG (TEVES). Any reproduction, disclosure or use of either is prohibited without the prior written consent of TEVES. TEVES reserve worldwide all rights also in case of industrial property rights being granted. The same provisions apply to any oral communications related thereto accordingly.



Customer Product Specification
MK25 Safety Concept
TOYOTA 532N ABS/EBD/BTRAC/ETRAC/VSC/HBA

ATE N 655 66.14
Sheet 152
Page 75 of 206

ALLE RECHTE VORBEHALTEN

EIGENTUM DER CONTINENTAL TEVES AG & CO. OHG

VERTRAULICH

Dieser Informationsträger und die darin enthaltenen Informationen sind Eigentum von Continental Teves AG & Co. oHG (TEVES). Jegliche Vervielfältigung, Offenbarung oder Benutzung dieser Informationen ist ohne vorherige schriftliche Zustimmung von TEVES verboten. TEVES behält sich weltweit alle Rechte auch für den Fall der Erteilung von gewerblichen Schutzrechten vor. Die gleichen Regelungen gelten für diesbezügliche mündliche Mitteilungen entsprechend.



CONFIDENTIAL AND PROPRIETARY
This information carrier and the information it contains are the property of Continental Teves AG & Co. oHG (TEVES). Any reproduction, disclosure or use of either is prohibited without the prior written consent of TEVES. TEVES reserve worldwide all rights also in case of industrial property rights being granted. The same provisions apply to any oral communications related thereto accordingly.



Customer Product Specification
MK25 Safety Concept
TOYOTA 532N ABS/EBD/BTRAC/ETRAC/VSC/HBA

ATE N 655 66.14
Sheet 152
Page 76 of 206

ALLE RECHTE VORBEHALTEN

EIGENTUM DER CONTINENTAL TEVES AG & CO. OHG

VERTRAULICH

Dieser Informationsträger und die darin enthaltenen Informationen sind Eigentum von Continental Teves AG & Co. oHG (TEVES). Jegliche Vervielfältigung, Offenbarung oder Benutzung dieser Informationen ist ohne vorherige schriftliche Zustimmung von TEVES verboten. TEVES behält sich weltweit alle Rechte auch für den Fall der Erteilung von gewerblichen Schutzrechten vor. Die gleichen Regelungen gelten für diesbezügliche mündliche Mitteilungen entsprechend.



CONFIDENTIAL AND PROPRIETARY
This information carrier and the information it contains are the property of Continental Teves AG & Co. oHG (TEVES). Any reproduction, disclosure or use of either is prohibited without the prior written consent of TEVES. TEVES reserve worldwide all rights also in case of industrial property rights being granted. The same provisions apply to any oral communications related thereto accordingly.

PROPERTY OF CONTINENTAL TEVES AG & CO. OHG
ALL RIGHTS RESERVED



Customer Product Specification
MK25 Safety Concept
TOYOTA 532N ABS/EBD/BTRAC/ETRAC/VSC/HBA

ATE N 655 66.14
Sheet 152
Page 77 of 206

ALLE RECHTE VORBEHALTEN

EIGENTUM DER CONTINENTAL TEVES AG & CO. OHG

VERTRAULICH

Dieser Informationsträger und die darin enthaltenen Informationen sind Eigentum von Continental Teves AG & Co. oHG (TEVES). Jegliche Vervielfältigung, Offenbarung oder Benutzung dieser Informationen ist ohne vorherige schriftliche Zustimmung von TEVES verboten. TEVES behält sich weltweit alle Rechte auch für den Fall der Erteilung von gewerblichen Schutzrechten vor. Die gleichen Regelungen gelten für diesbezügliche mündliche Mitteilungen entsprechend.





Customer Product Specification
MK25 Safety Concept
TOYOTA 532N ABS/EBD/BTRAC/ETRAC/VSC/HBA

ATE N 655 66.14
Sheet 152
Page 79 of 206

ALLE RECHTE VORBEHALTEN

EIGENTUM DER CONTINENTAL TEVES AG & CO. OHG

VERTRAULICH

Dieser Informationsträger und die darin enthaltenen Informationen sind Eigentum von Continental Teves AG & Co. oHG (TEVES). Jegliche Vervielfältigung, Offenbarung oder Benutzung dieser Informationen ist ohne vorherige schriftliche Zustimmung von TEVES verboten. TEVES behält sich weltweit alle Rechte auch für den Fall der Erteilung von gewerblichen Schutzrechten vor. Die gleichen Regelungen gelten für diesbezügliche mündliche Mitteilungen entsprechend.



CONFIDENTIAL AND PROPRIETARY
This information carrier and the information it contains are the property of Continental Teves AG & Co. oHG (TEVES). Any reproduction, disclosure or use of either is prohibited without the prior written consent of TEVES. TEVES reserve worldwide all rights also in case of industrial property rights being granted. The same provisions apply to any oral communications related thereto accordingly.

PROPERTY OF CONTINENTAL TEVES AG & CO. OHG
ALL RIGHTS RESERVED



Customer Product Specification
MK25 Safety Concept
TOYOTA 532N ABS/EBD/BTRAC/ETRAC/VSC/HBA

ATE N 655 66.14
Sheet 152
Page 80 of 206

ALLE RECHTE VORBEHALTEN

EIGENTUM DER CONTINENTAL TEVES AG & CO. OHG

VERTRAULICH

Dieser Informationsträger und die darin enthaltenen Informationen sind Eigentum von Continental Teves AG & Co. oHG (TEVES). Jegliche Vervielfältigung, Offenbarung oder Benutzung dieser Informationen ist ohne vorherige schriftliche Zustimmung von TEVES verboten. TEVES behält sich weltweit alle Rechte auch für den Fall der Erteilung von gewerblichen Schutzrechten vor. Die gleichen Regelungen gelten für diesbezügliche mündliche Mitteilungen entsprechend.





Customer Product Specification
MK25 Safety Concept
TOYOTA 532N ABS/EBD/BTRAC/ETRAC/VSC/HBA

ATE N 655 66.14
Sheet 152
Page 81 of 206

ALLE RECHTE VORBEHALTEN

EIGENTUM DER CONTINENTAL TEVES AG & CO. OHG

VERTRAULICH

Dieser Informationsträger und die darin enthaltenen Informationen sind Eigentum von Continental Teves AG & Co. oHG (TEVES). Jegliche Vervielfältigung, Offenbarung oder Benutzung dieser Informationen ist ohne vorherige schriftliche Zustimmung von TEVES verboten. TEVES behält sich weltweit alle Rechte auch für den Fall der Erteilung von gewerblichen Schutzrechten vor. Die gleichen Regelungen gelten für diesbezügliche mündliche Mitteilungen entsprechend.





Customer Product Specification
MK25 Safety Concept
TOYOTA 532N ABS/EBD/BTRAC/ETRAC/VSC/HBA

ATE N 655 66.14
Sheet 152
Page 82 of 206

ALLE RECHTE VORBEHALTEN

EIGENTUM DER CONTINENTAL TEVES AG & CO. OHG

VERTRAULICH

Dieser Informationsträger und die darin enthaltenen Informationen sind Eigentum von Continental Teves AG & Co. oHG (TEVES). Jegliche Vervielfältigung, Offenbarung oder Benutzung dieser Informationen ist ohne vorherige schriftliche Zustimmung von TEVES verboten. TEVES behält sich weltweit alle Rechte auch für den Fall der Erteilung von gewerblichen Schutzrechten vor. Die gleichen Regelungen gelten für diesbezügliche mündliche Mitteilungen entsprechend.





Customer Product Specification
MK25 Safety Concept
TOYOTA 532N ABS/EBD/BTRAC/ETRAC/VSC/HBA

ATE N 655 66.14
Sheet 152
Page 83 of 206

ALLE RECHTE VORBEHALTEN

EIGENTUM DER CONTINENTAL TEVES AG & CO. OHG

VERTRAULICH

Dieser Informationsträger und die darin enthaltenen Informationen sind Eigentum von Continental Teves AG & Co. oHG (TEVES). Jegliche Vervielfältigung, Offenbarung oder Benutzung dieser Informationen ist ohne vorherige schriftliche Zustimmung von TEVES verboten. TEVES behält sich weltweit alle Rechte auch für den Fall der Erteilung von gewerblichen Schutzrechten vor. Die gleichen Regelungen gelten für diesbezügliche mündliche Mitteilungen entsprechend.

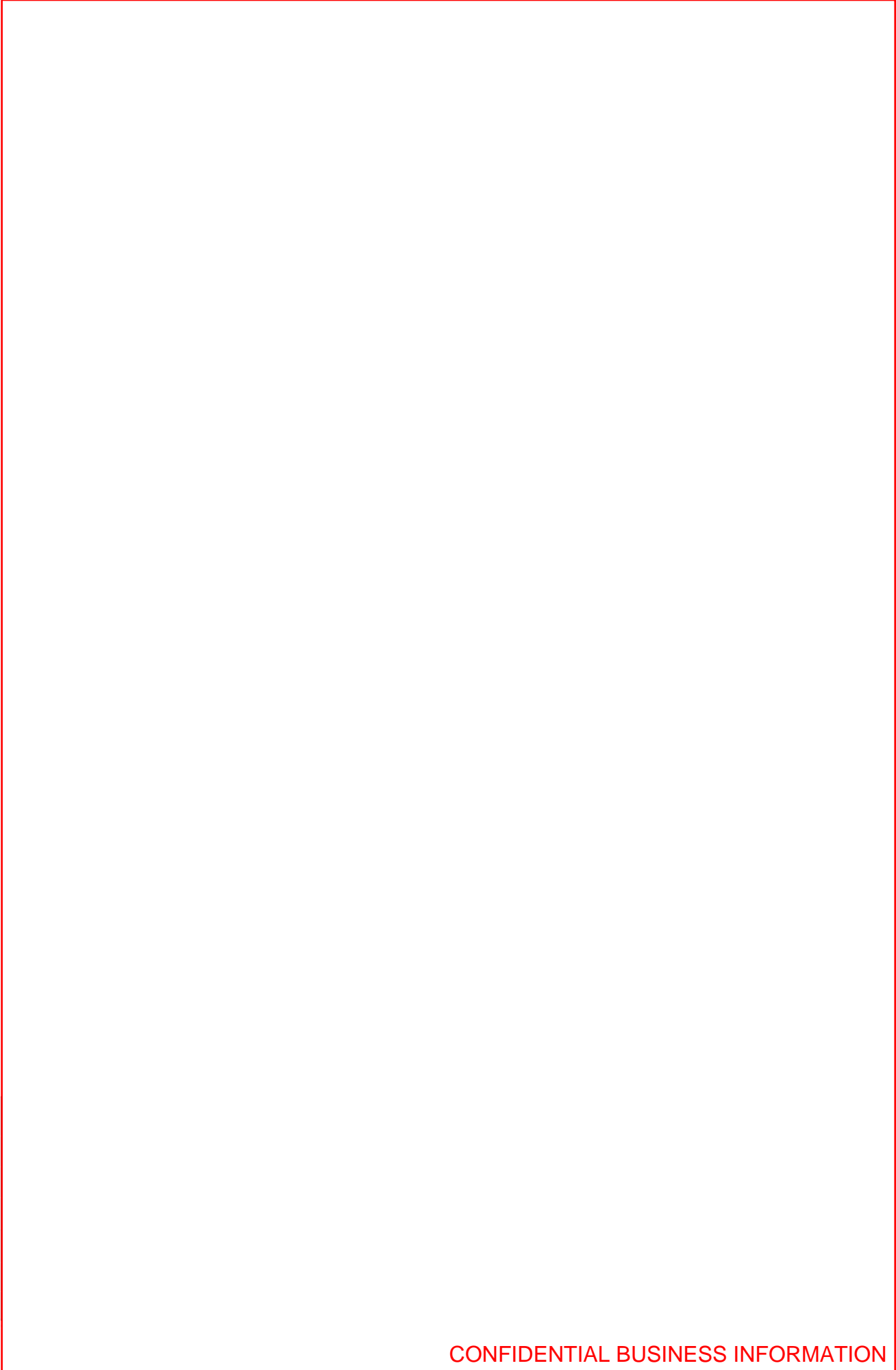



Customer Product Specification
MK25 Safety Concept
TOYOTA 532N ABS/EBD/BTRAC/ETRAC/VSC/HBA

ATE N 655 66.14
Sheet 152
Page 84 of 206

ALLE RECHTE VORBEHALTEN

EIGENTUM DER CONTINENTAL TEVES AG & CO. OHG

VERTRAULICH

Dieser Informationsträger und die darin enthaltenen Informationen sind Eigentum von Continental Teves AG & Co. oHG (TEVES). Jegliche Vervielfältigung, Offenbarung oder Benutzung dieser Informationen ist ohne vorherige schriftliche Zustimmung von TEVES verboten. TEVES behält sich weltweit alle Rechte auch für den Fall der Erteilung von gewerblichen Schutzrechten vor. Die gleichen Regelungen gelten für diesbezügliche mündliche Mitteilungen entsprechend.



CONFIDENTIAL AND PROPRIETARY
This information carrier and the information it contains are the property of Continental Teves AG & Co. oHG (TEVES). Any reproduction, disclosure or use of either is prohibited without the prior written consent of TEVES. TEVES reserve worldwide all rights also in case of industrial property rights being granted. The same provisions apply to any oral communications related thereto accordingly.

PROPERTY OF CONTINENTAL TEVES AG & CO. OHG
ALL RIGHTS RESERVED



Customer Product Specification
MK25 Safety Concept
TOYOTA 532N ABS/EBD/BTRAC/ETRAC/VSC/HBA

ATE N 655 66.14
Sheet 152
Page 85 of 206

ALLE RECHTE VORBEHALTEN

EIGENTUM DER CONTINENTAL TEVES AG & CO. OHG

VERTRAULICH

Dieser Informationsträger und die darin enthaltenen Informationen sind Eigentum von Continental Teves AG & Co. oHG (TEVES). Jegliche Vervielfältigung, Offenbarung oder Benutzung dieser Informationen ist ohne vorherige schriftliche Zustimmung von TEVES verboten. TEVES behält sich weltweit alle Rechte auch für den Fall der Erteilung von gewerblichen Schutzrechten vor. Die gleichen Regelungen gelten für diesbezügliche mündliche Mitteilungen entsprechend.





Customer Product Specification
MK25 Safety Concept
TOYOTA 532N ABS/EBD/BTRAC/ETRAC/VSC/HBA

ATE N 655 66.14
Sheet 152
Page 86 of 206

ALLE RECHTE VORBEHALTEN

EIGENTUM DER CONTINENTAL TEVES AG & CO. OHG

VERTRAULICH

Dieser Informationsträger und die darin enthaltenen Informationen sind Eigentum von Continental Teves AG & Co. oHG (TEVES). Jegliche Vervielfältigung, Offenbarung oder Benutzung dieser Informationen ist ohne vorherige schriftliche Zustimmung von TEVES verboten. TEVES behält sich weltweit alle Rechte auch für den Fall der Erteilung von gewerblichen Schutzrechten vor. Die gleichen Regelungen gelten für diesbezügliche mündliche Mitteilungen entsprechend.



CONFIDENTIAL AND PROPRIETARY
This information carrier and the information it contains are the property of Continental Teves AG & Co. oHG (TEVES). Any reproduction, disclosure or use of either is prohibited without the prior written consent of TEVES. TEVES reserve worldwide all rights also in case of industrial property rights being granted. The same provisions apply to any oral communications related thereto accordingly.

PROPERTY OF CONTINENTAL TEVES AG & CO. OHG
ALL RIGHTS RESERVED



Customer Product Specification
MK25 Safety Concept
TOYOTA 532N ABS/EBD/BTRAC/ETRAC/VSC/HBA

ATE N 655 66.14
Sheet 152
Page 87 of 206

ALLE RECHTE VORBEHALTEN

EIGENTUM DER CONTINENTAL TEVES AG & CO. OHG

VERTRAULICH

Dieser Informationsträger und die darin enthaltenen Informationen sind Eigentum von Continental Teves AG & Co. oHG (TEVES). Jegliche Vervielfältigung, Offenbarung oder Benutzung dieser Informationen ist ohne vorherige schriftliche Zustimmung von TEVES verboten. TEVES behält sich weltweit alle Rechte auch für den Fall der Erteilung von gewerblichen Schutzrechten vor. Die gleichen Regelungen gelten für diesbezügliche mündliche Mitteilungen entsprechend.





Customer Product Specification
MK25 Safety Concept
TOYOTA 532N ABS/EBD/BTRAC/ETRAC/VSC/HBA

ATE N 655 66.14
Sheet 152
Page 88 of 206

ALLE RECHTE VORBEHALTEN

EIGENTUM DER CONTINENTAL TEVES AG & CO. OHG

VERTRAULICH

Dieser Informationsträger und die darin enthaltenen Informationen sind Eigentum von Continental Teves AG & Co. oHG (TEVES). Jegliche Vervielfältigung, Offenbarung oder Benutzung dieser Informationen ist ohne vorherige schriftliche Zustimmung von TEVES verboten. TEVES behält sich weltweit alle Rechte auch für den Fall der Erteilung von gewerblichen Schutzrechten vor. Die gleichen Regelungen gelten für diesbezügliche mündliche Mitteilungen entsprechend.

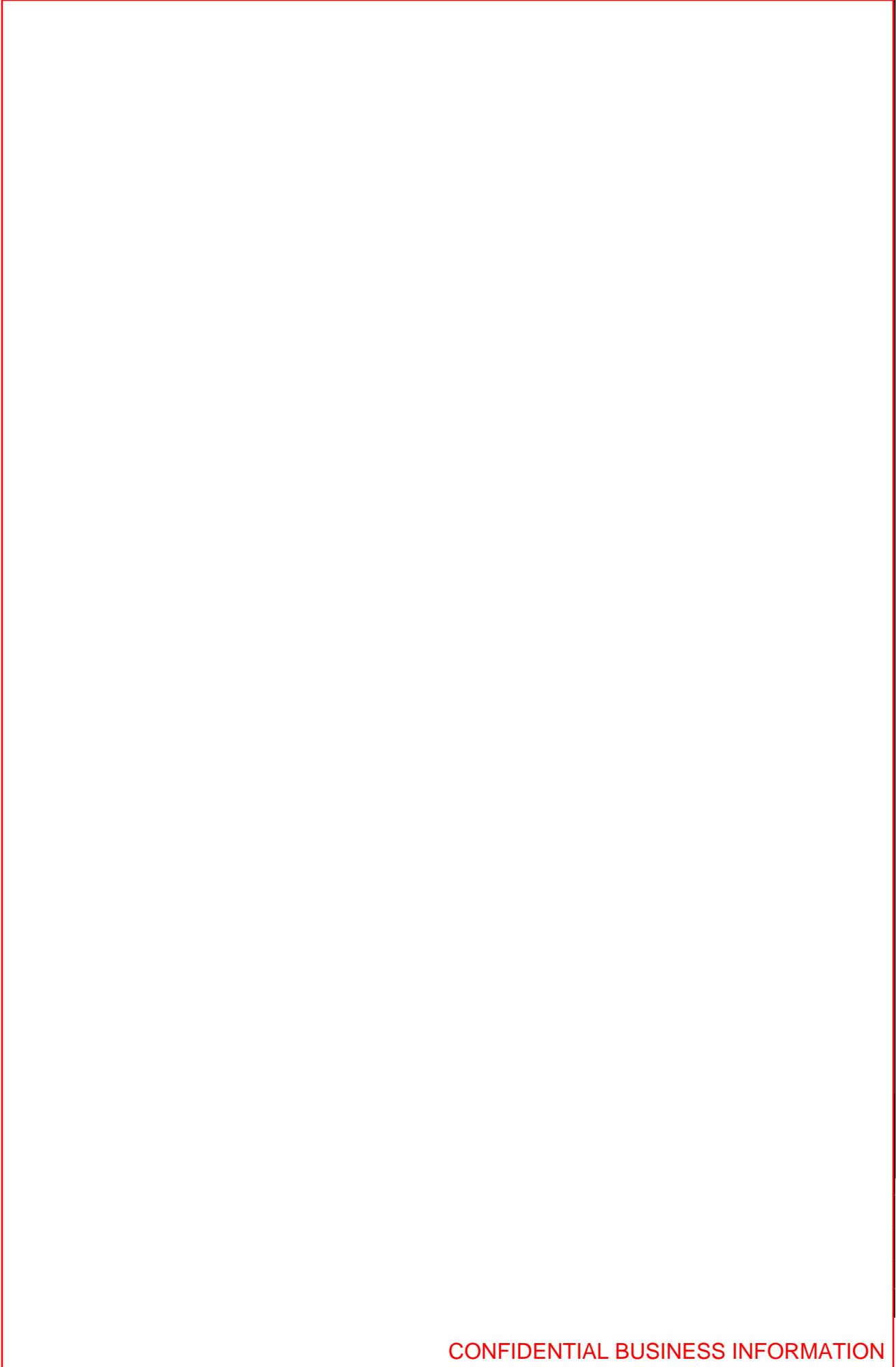

ALL RIGHTS RESERVED
PROPERTY OF CONTINENTAL TEVES AG & CO. OHG
This information carrier and the information it contains are the property of Continental Teves AG & Co. oHG (TEVES). Any reproduction, disclosure or use of either is prohibited without the prior written consent of TEVES. TEVES reserve worldwide all rights also in case of industrial property rights being granted. The same provisions apply to any oral communications related thereto accordingly.



Customer Product Specification
MK25 Safety Concept
TOYOTA 532N ABS/EBD/BTRAC/ETRAC/VSC/HBA

ATE N 655 66.14
Sheet 152
Page 89 of 206

ALLE RECHTE VORBEHALTEN

EIGENTUM DER CONTINENTAL TEVES AG & CO. OHG

VERTRAULICH

Dieser Informationsträger und die darin enthaltenen Informationen sind Eigentum von Continental Teves AG & Co. oHG (TEVES). Jegliche Vervielfältigung, Offenbarung oder Benutzung dieser Informationen ist ohne vorherige schriftliche Zustimmung von TEVES verboten. TEVES behält sich weltweit alle Rechte auch für den Fall der Erteilung von gewerblichen Schutzrechten vor. Die gleichen Regelungen gelten für diesbezügliche mündliche Mitteilungen entsprechend.





Customer Product Specification
MK25 Safety Concept
TOYOTA 532N ABS/EBD/BTRAC/ETRAC/VSC/HBA

ATE N 655 66.14
Sheet 152
Page 90 of 206

ALLE RECHTE VORBEHALTEN

EIGENTUM DER CONTINENTAL TEVES AG & CO. OHG

VERTRAULICH

Dieser Informationsträger und die darin enthaltenen Informationen sind Eigentum von Continental Teves AG & Co. oHG (TEVES). Jegliche Vervielfältigung, Offenbarung oder Benutzung dieser Informationen ist ohne vorherige schriftliche Zustimmung von TEVES verboten. TEVES behält sich weltweit alle Rechte auch für den Fall der Erteilung von gewerblichen Schutzrechten vor. Die gleichen Regelungen gelten für diesbezügliche mündliche Mitteilungen entsprechend.



CONFIDENTIAL AND PROPRIETARY
This information carrier and the information it contains are the property of Continental Teves AG & Co. oHG (TEVES). Any reproduction, disclosure or use of either is prohibited without the prior written consent of TEVES. TEVES reserve worldwide all rights also in case of industrial property rights being granted. The same provisions apply to any oral communications related thereto accordingly.

PROPERTY OF CONTINENTAL TEVES AG & CO. OHG
ALL RIGHTS RESERVED



Customer Product Specification
MK25 Safety Concept
TOYOTA 532N ABS/EBD/BTRAC/ETRAC/VSC/HBA

ATE N 655 66.14
Sheet 152
Page 91 of 206

ALLE RECHTE VORBEHALTEN

EIGENTUM DER CONTINENTAL TEVES AG & CO. OHG

VERTRAULICH

Dieser Informationsträger und die darin enthaltenen Informationen sind Eigentum von Continental Teves AG & Co. oHG (TEVES). Jegliche Vervielfältigung, Offenbarung oder Benutzung dieser Informationen ist ohne vorherige schriftliche Zustimmung von TEVES verboten. TEVES behält sich weltweit alle Rechte auch für den Fall der Erteilung von gewerblichen Schutzrechten vor. Die gleichen Regelungen gelten für diesbezügliche mündliche Mitteilungen entsprechend.



ALL RIGHTS RESERVED
PROPERTY OF CONTINENTAL TEVES AG & CO. OHG
This information carrier and the information it contains are the property of Continental Teves AG & Co. oHG (TEVES). Any reproduction, disclosure or use of either is prohibited without the prior written consent of TEVES. TEVES reserve worldwide all rights also in case of industrial property rights being granted. The same provisions apply to any oral communications related thereto accordingly.



Customer Product Specification
MK25 Safety Concept
TOYOTA 532N ABS/EBD/BTRAC/ETRAC/VSC/HBA

ATE N 655 66.14
Sheet 152
Page 92 of 206

ALLE RECHTE VORBEHALTEN

EIGENTUM DER CONTINENTAL TEVES AG & CO. OHG

VERTRAULICH

Dieser Informationsträger und die darin enthaltenen Informationen sind Eigentum von Continental Teves AG & Co. oHG (TEVES). Jegliche Vervielfältigung, Offenbarung oder Benutzung dieser Informationen ist ohne vorherige schriftliche Zustimmung von TEVES verboten. TEVES behält sich weltweit alle Rechte auch für den Fall der Erteilung von gewerblichen Schutzrechten vor. Die gleichen Regelungen gelten für diesbezügliche mündliche Mitteilungen entsprechend.

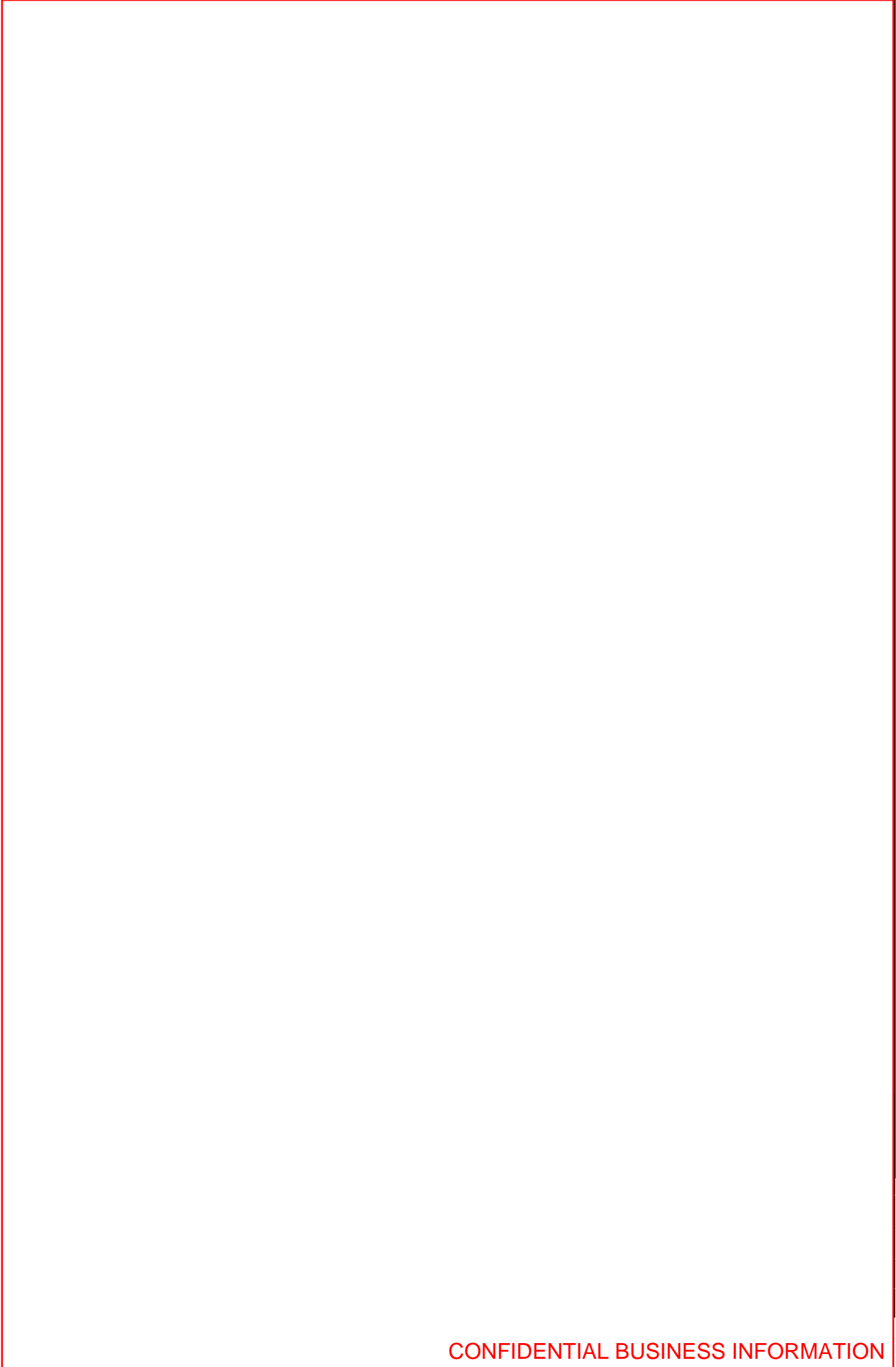

CONFIDENTIAL AND PROPRIETARY
This information carrier and the information it contains are the property of Continental Teves AG & Co. oHG (TEVES). Any reproduction, disclosure or use of either is prohibited without the prior written consent of TEVES. TEVES reserve worldwide all rights also in case of industrial property rights being granted. The same provisions apply to any oral communications related thereto accordingly.

PROPERTY OF CONTINENTAL TEVES AG & CO. OHG
ALL RIGHTS RESERVED



Customer Product Specification
MK25 Safety Concept
TOYOTA 532N ABS/EBD/BTRAC/ETRAC/VSC/HBA

ATE N 655 66.14
Sheet 152
Page 93 of 206

ALLE RECHTE VORBEHALTEN

EIGENTUM DER CONTINENTAL TEVES AG & CO. OHG

VERTRAULICH

Dieser Informationsträger und die darin enthaltenen Informationen sind Eigentum von Continental Teves AG & Co. oHG (TEVES). Jegliche Vervielfältigung, Offenbarung oder Benutzung dieser Informationen ist ohne vorherige schriftliche Zustimmung von TEVES verboten. TEVES behält sich weltweit alle Rechte auch für den Fall der Erteilung von gewerblichen Schutzrechten vor. Die gleichen Regelungen gelten für diesbezügliche mündliche Mitteilungen entsprechend.



CONFIDENTIAL AND PROPRIETARY
This information carrier and the information it contains are the property of Continental Teves AG & Co. oHG (TEVES). Any reproduction, disclosure or use of either is prohibited without the prior written consent of TEVES. TEVES reserve worldwide all rights also in case of industrial property rights being granted. The same provisions apply to any oral communications related thereto accordingly.

PROPERTY OF CONTINENTAL TEVES AG & CO. OHG
ALL RIGHTS RESERVED



Customer Product Specification
MK25 Safety Concept
TOYOTA 532N ABS/EBD/BTRAC/ETRAC/VSC/HBA

ATE N 655 66.14
Sheet 152
Page 94 of 206

ALLE RECHTE VORBEHALTEN

EIGENTUM DER CONTINENTAL TEVES AG & CO. OHG

VERTRAULICH

Dieser Informationsträger und die darin enthaltenen Informationen sind Eigentum von Continental Teves AG & Co. oHG (TEVES). Jegliche Vervielfältigung, Offenbarung oder Benutzung dieser Informationen ist ohne vorherige schriftliche Zustimmung von TEVES verboten. TEVES behält sich weltweit alle Rechte auch für den Fall der Erteilung von gewerblichen Schutzrechten vor. Die gleichen Regelungen gelten für diesbezügliche mündliche Mitteilungen entsprechend.



ALL RIGHTS RESERVED
PROPERTY OF CONTINENTAL TEVES AG & CO. OHG
This information carrier and the information it contains are the property of Continental Teves AG & Co. oHG (TEVES). Any reproduction, disclosure or use of either is prohibited without the prior written consent of TEVES. TEVES reserve worldwide all rights also in case of industrial property rights being granted. The same provisions apply to any oral communications related thereto accordingly.



Customer Product Specification
MK25 Safety Concept
TOYOTA 532N ABS/EBD/BTRAC/ETRAC/VSC/HBA

ATE N 655 66.14
Sheet 152
Page 95 of 206

ALLE RECHTE VORBEHALTEN

EIGENTUM DER CONTINENTAL TEVES AG & CO. OHG

VERTRAULICH

Dieser Informationsträger und die darin enthaltenen Informationen sind Eigentum von Continental Teves AG & Co. oHG (TEVES). Jegliche Vervielfältigung, Offenbarung oder Benutzung dieser Informationen ist ohne vorherige schriftliche Zustimmung von TEVES verboten. TEVES behält sich weltweit alle Rechte auch für den Fall der Erteilung von gewerblichen Schutzrechten vor. Die gleichen Regelungen gelten für diesbezügliche mündliche Mitteilungen entsprechend.



CONFIDENTIAL AND PROPRIETARY
This information carrier and the information it contains are the property of Continental Teves AG & Co. oHG (TEVES). Any reproduction, disclosure or use of either is prohibited without the prior written consent of TEVES. TEVES reserve worldwide all rights also in case of industrial property rights being granted. The same provisions apply to any oral communications related thereto accordingly.

PROPERTY OF CONTINENTAL TEVES AG & CO. OHG
ALL RIGHTS RESERVED



Customer Product Specification
MK25 Safety Concept
TOYOTA 532N ABS/EBD/BTRAC/ETRAC/VSC/HBA

ATE N 655 66.14
Sheet 152
Page 96 of 206

ALLE RECHTE VORBEHALTEN

EIGENTUM DER CONTINENTAL TEVES AG & CO. OHG

VERTRAULICH

Dieser Informationsträger und die darin enthaltenen Informationen sind Eigentum von Continental Teves AG & Co. oHG (TEVES). Jegliche Vervielfältigung, Offenbarung oder Benutzung dieser Informationen ist ohne vorherige schriftliche Zustimmung von TEVES verboten. TEVES behält sich weltweit alle Rechte auch für den Fall der Erteilung von gewerblichen Schutzrechten vor. Die gleichen Regelungen gelten für diesbezügliche mündliche Mitteilungen entsprechend.

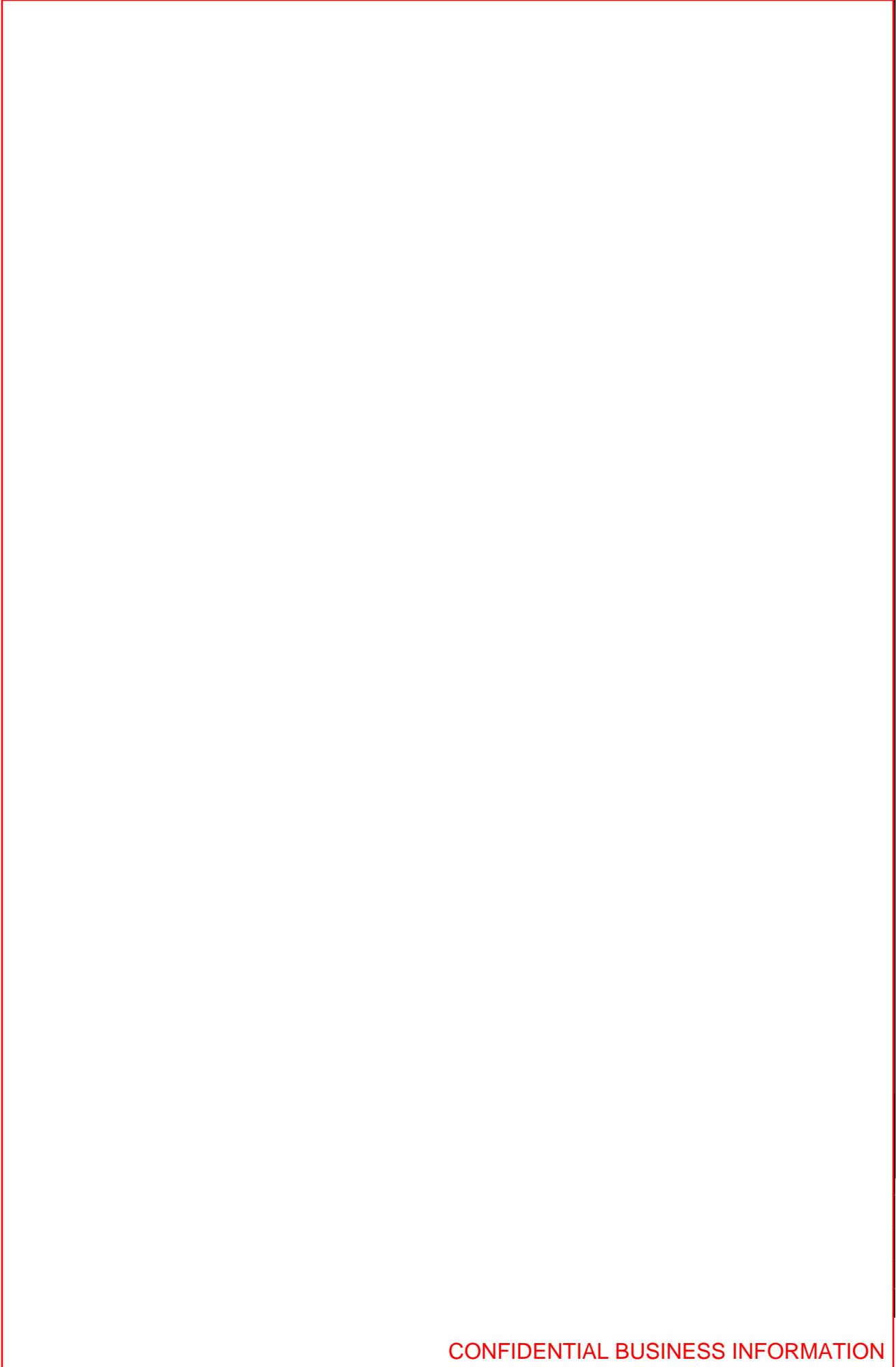

CONFIDENTIAL AND PROPRIETARY
This information carrier and the information it contains are the property of Continental Teves AG & Co. oHG (TEVES). Any reproduction, disclosure or use of either is prohibited without the prior written consent of TEVES. TEVES reserve worldwide all rights also in case of industrial property rights being granted. The same provisions apply to any oral communications related thereto accordingly.

PROPERTY OF CONTINENTAL TEVES AG & CO. OHG
ALL RIGHTS RESERVED



Customer Product Specification
MK25 Safety Concept
TOYOTA 532N ABS/EBD/BTRAC/ETRAC/VSC/HBA

ATE N 655 66.14
Sheet 152
Page 97 of 206

ALLE RECHTE VORBEHALTEN

EIGENTUM DER CONTINENTAL TEVES AG & CO. OHG

VERTRAULICH

Dieser Informationsträger und die darin enthaltenen Informationen sind Eigentum von Continental Teves AG & Co. oHG (TEVES). Jegliche Vervielfältigung, Offenbarung oder Benutzung dieser Informationen ist ohne vorherige schriftliche Zustimmung von TEVES verboten. TEVES behält sich weltweit alle Rechte auch für den Fall der Erteilung von gewerblichen Schutzrechten vor. Die gleichen Regelungen gelten für diesbezügliche mündliche Mitteilungen entsprechend.

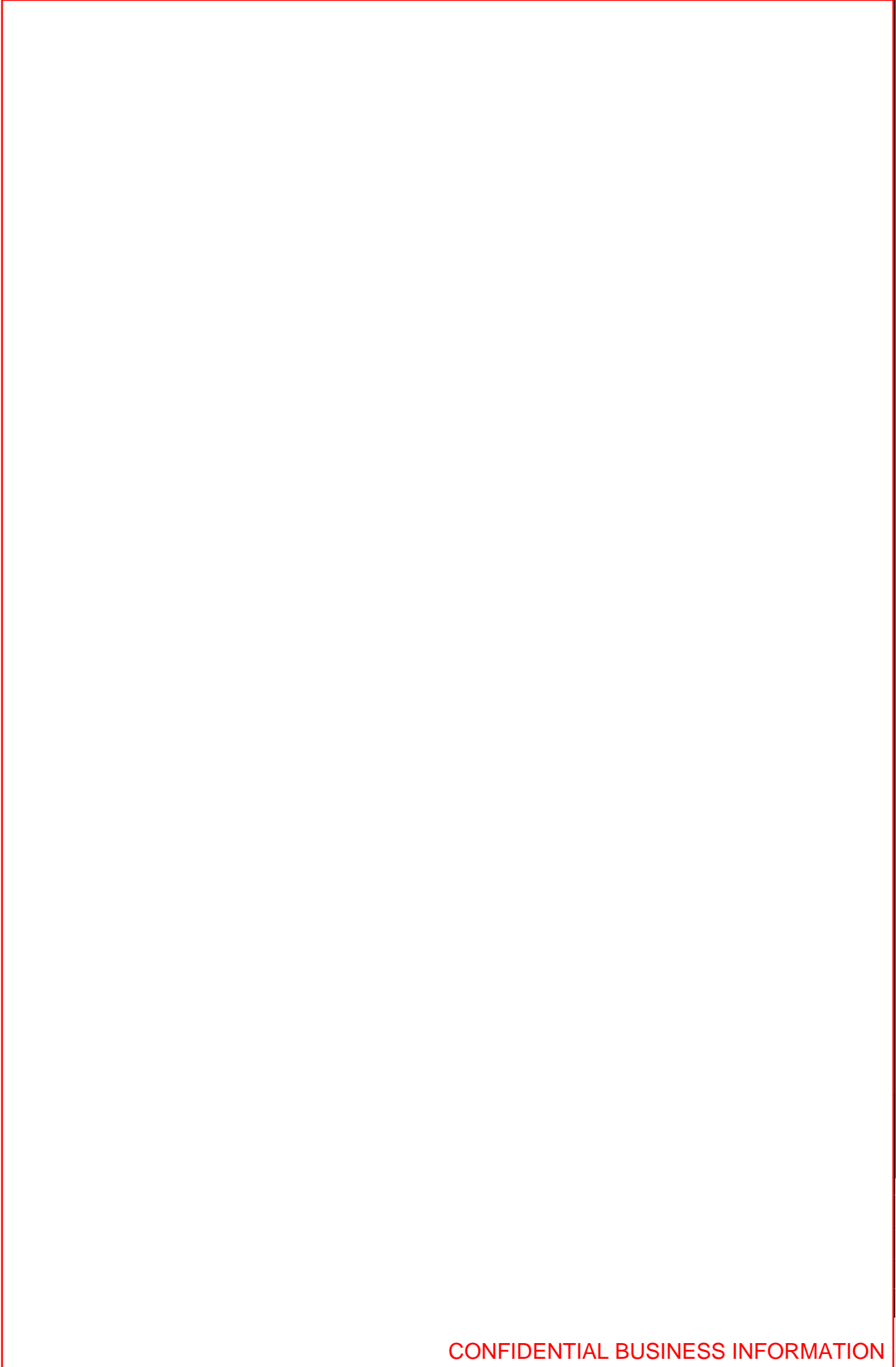

ALL RIGHTS RESERVED
PROPERTY OF CONTINENTAL TEVES AG & CO. OHG
This information carrier and the information it contains are the property of Continental Teves AG & Co. oHG (TEVES). Any reproduction, disclosure or use of either is prohibited without the prior written consent of TEVES. TEVES reserve worldwide all rights also in case of industrial property rights being granted. The same provisions apply to any oral communications related thereto accordingly.



Customer Product Specification
MK25 Safety Concept
TOYOTA 532N ABS/EBD/BTRAC/ETRAC/VSC/HBA

ATE N 655 66.14
Sheet 152
Page 98 of 206

ALLE RECHTE VORBEHALTEN

EIGENTUM DER CONTINENTAL TEVES AG & CO. OHG

VERTRAULICH

Dieser Informationsträger und die darin enthaltenen Informationen sind Eigentum von Continental Teves AG & Co. oHG (TEVES). Jegliche Vervielfältigung, Offenbarung oder Benutzung dieser Informationen ist ohne vorherige schriftliche Zustimmung von TEVES verboten. TEVES behält sich weltweit alle Rechte auch für den Fall der Erteilung von gewerblichen Schutzrechten vor. Die gleichen Regelungen gelten für diesbezügliche mündliche Mitteilungen entsprechend.

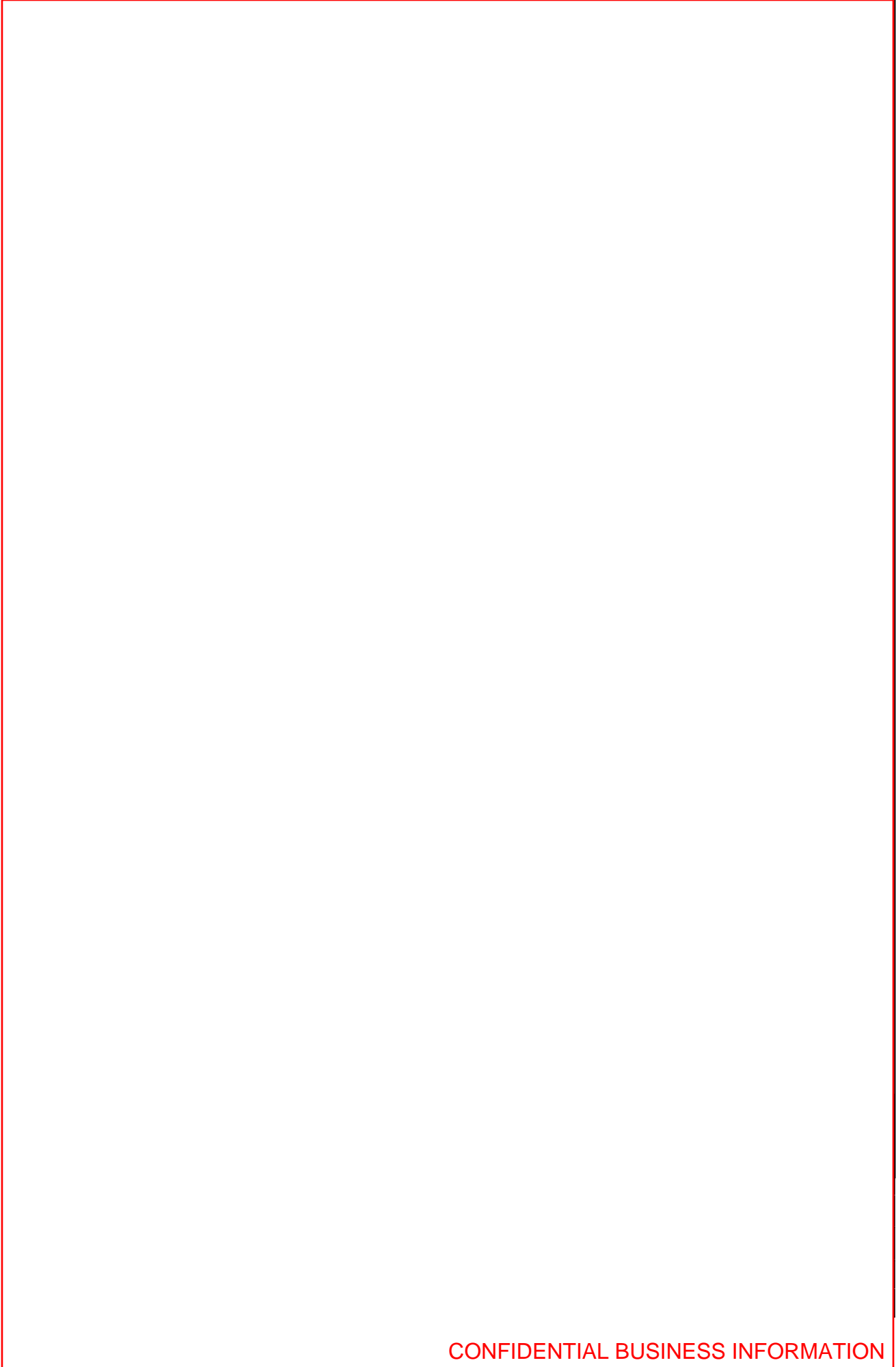

CONFIDENTIAL AND PROPRIETARY
This information carrier and the information it contains are the property of Continental Teves AG & Co. oHG (TEVES). Any reproduction, disclosure or use of either is prohibited without the prior written consent of TEVES. TEVES reserve worldwide all rights also in case of industrial property rights being granted. The same provisions apply to any oral communications related thereto accordingly.

PROPERTY OF CONTINENTAL TEVES AG & CO. OHG
ALL RIGHTS RESERVED



Customer Product Specification
MK25 Safety Concept
TOYOTA 532N ABS/EBD/BTRAC/ETRAC/VSC/HBA

ATE N 655 66.14
Sheet 152
Page 99 of 206

ALLE RECHTE VORBEHALTEN

EIGENTUM DER CONTINENTAL TEVES AG & CO. OHG

VERTRAULICH

Dieser Informationsträger und die darin enthaltenen Informationen sind Eigentum von Continental Teves AG & Co. oHG (TEVES). Jegliche Vervielfältigung, Offenbarung oder Benutzung dieser Informationen ist ohne vorherige schriftliche Zustimmung von TEVES verboten. TEVES behält sich weltweit alle Rechte auch für den Fall der Erteilung von gewerblichen Schutzrechten vor. Die gleichen Regelungen gelten für diesbezügliche mündliche Mitteilungen entsprechend.



ALL RIGHTS RESERVED
PROPERTY OF CONTINENTAL TEVES AG & CO. OHG
This information carrier and the information it contains are the property of Continental Teves AG & Co. oHG (TEVES). Any reproduction, disclosure or use of either is prohibited without the prior written consent of TEVES. TEVES reserve worldwide all rights also in case of industrial property rights being granted. The same provisions apply to any oral communications related thereto accordingly.



Customer Product Specification
MK25 Safety Concept
TOYOTA 532N ABS/EBD/BTRAC/ETRAC/VSC/HBA

ATE N 655 66.14
Sheet 152
Page 100 of 206

ALLE RECHTE VORBEHALTEN

EIGENTUM DER CONTINENTAL TEVES AG & CO. OHG

VERTRAULICH

Dieser Informationsträger und die darin enthaltenen Informationen sind Eigentum von Continental Teves AG & Co. oHG (TEVES). Jegliche Vervielfältigung, Offenbarung oder Benutzung dieser Informationen ist ohne vorherige schriftliche Zustimmung von TEVES verboten. TEVES behält sich weltweit alle Rechte auch für den Fall der Erteilung von gewerblichen Schutzrechten vor. Die gleichen Regelungen gelten für diesbezügliche mündliche Mitteilungen entsprechend.

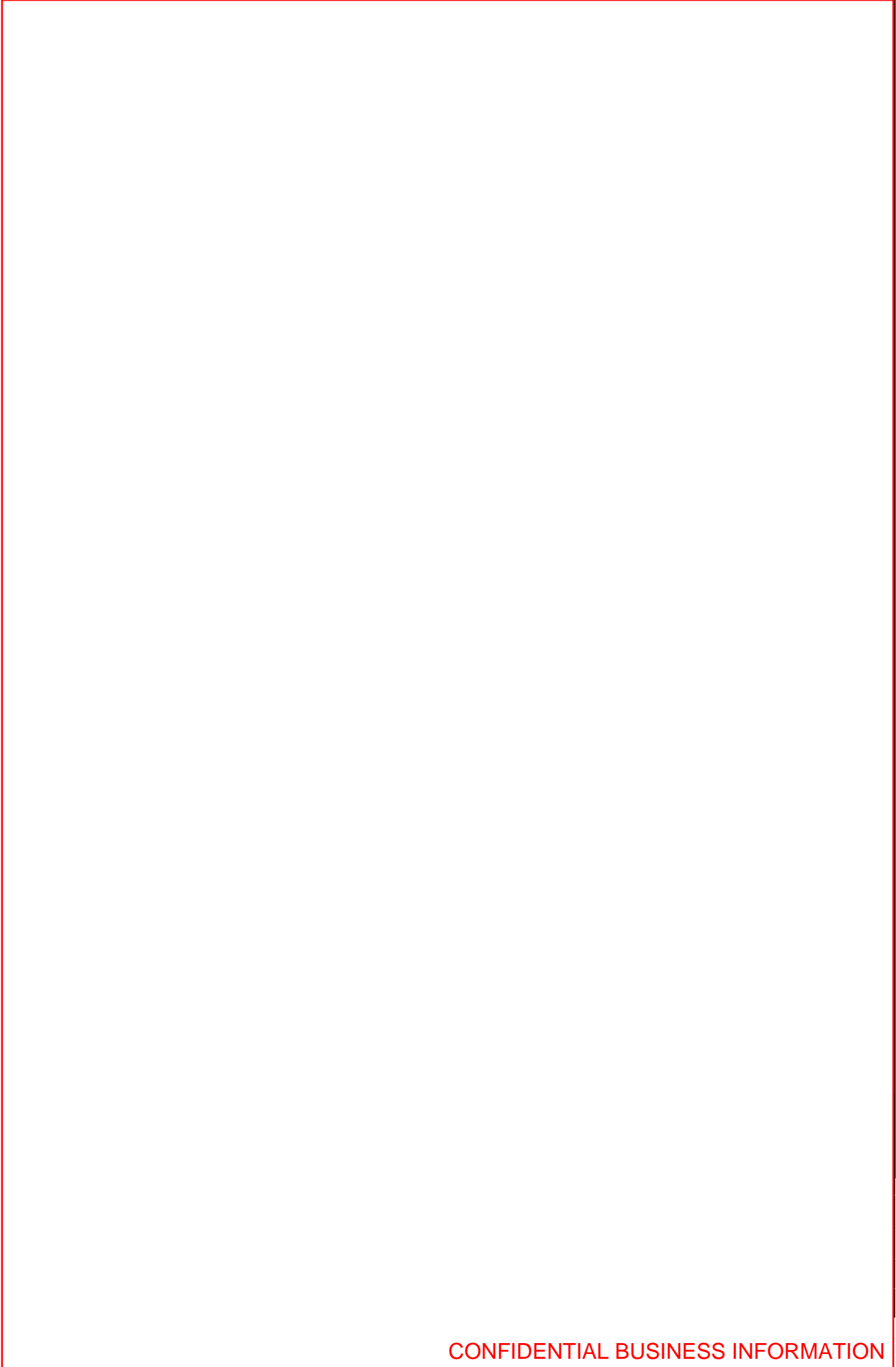

ALL RIGHTS RESERVED
PROPERTY OF CONTINENTAL TEVES AG & CO. OHG
This information carrier and the information it contains are the property of Continental Teves AG & Co. oHG (TEVES). Any reproduction, disclosure or use of either is prohibited without the prior written consent of TEVES. TEVES reserve worldwide all rights also in case of industrial property rights being granted. The same provisions apply to any oral communications related thereto accordingly.



Customer Product Specification
MK25 Safety Concept
TOYOTA 532N ABS/EBD/BTRAC/ETRAC/VSC/HBA

ATE N 655 66.14
Sheet 152
Page 101 of 206

ALLE RECHTE VORBEHALTEN

EIGENTUM DER CONTINENTAL TEVES AG & CO. OHG

VERTRAULICH

Dieser Informationsträger und die darin enthaltenen Informationen sind Eigentum von Continental Teves AG & Co. oHG (TEVES). Jegliche Vervielfältigung, Offenbarung oder Benutzung dieser Informationen ist ohne vorherige schriftliche Zustimmung von TEVES verboten. TEVES behält sich weltweit alle Rechte auch für den Fall der Erteilung von gewerblichen Schutzrechten vor. Die gleichen Regelungen gelten für diesbezügliche mündliche Mitteilungen entsprechend.

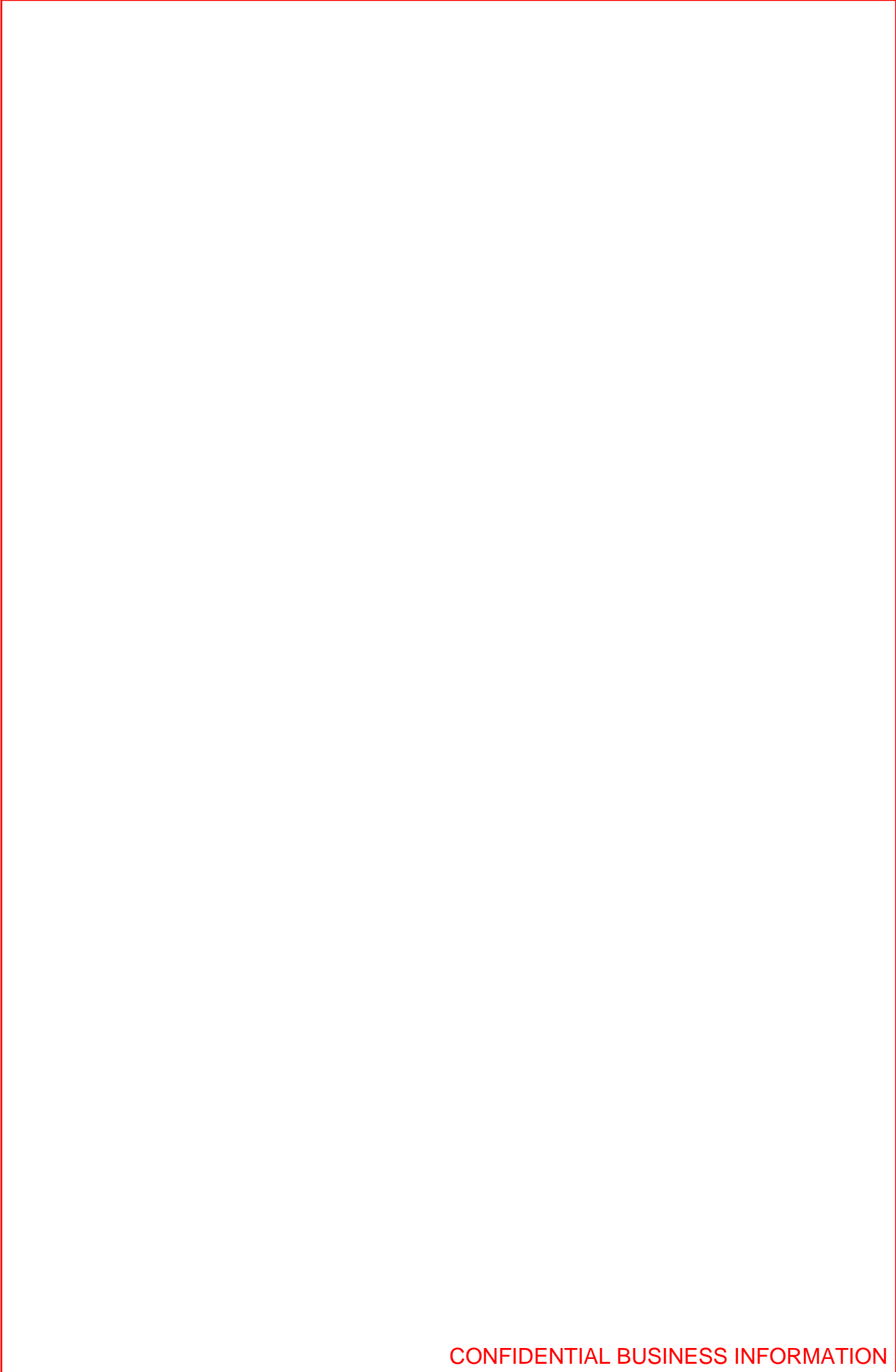



Customer Product Specification
MK25 Safety Concept
TOYOTA 532N ABS/EBD/BTRAC/ETRAC/VSC/HBA

ATE N 655 66.14
Sheet 152
Page 102 of 206

ALLE RECHTE VORBEHALTEN

EIGENTUM DER CONTINENTAL TEVES AG & CO. OHG

VERTRAULICH

Dieser Informationsträger und die darin enthaltenen Informationen sind Eigentum von Continental Teves AG & Co. oHG (TEVES). Jegliche Vervielfältigung, Offenbarung oder Benutzung dieser Informationen ist ohne vorherige schriftliche Zustimmung von TEVES verboten. TEVES behält sich weltweit alle Rechte auch für den Fall der Erteilung von gewerblichen Schutzrechten vor. Die gleichen Regelungen gelten für diesbezügliche mündliche Mitteilungen entsprechend.



ALL RIGHTS RESERVED
PROPERTY OF CONTINENTAL TEVES AG & CO. OHG
This information carrier and the information it contains are the property of Continental Teves AG & Co. oHG (TEVES). Any reproduction, disclosure or use of either is prohibited without the prior written consent of TEVES. TEVES reserve worldwide all rights also in case of industrial property rights being granted. The same provisions apply to any oral communications related thereto accordingly.



Customer Product Specification
MK25 Safety Concept
TOYOTA 532N ABS/EBD/BTRAC/ETRAC/VSC/HBA

ATE N 655 66.14
Sheet 152
Page 103 of 206

ALLE RECHTE VORBEHALTEN

EIGENTUM DER CONTINENTAL TEVES AG & CO. OHG

VERTRAULICH

Dieser Informationsträger und die darin enthaltenen Informationen sind Eigentum von Continental Teves AG & Co. oHG (TEVES). Jegliche Vervielfältigung, Offenbarung oder Benutzung dieser Informationen ist ohne vorherige schriftliche Zustimmung von TEVES verboten. TEVES behält sich weltweit alle Rechte auch für den Fall der Erteilung von gewerblichen Schutzrechten vor. Die gleichen Regelungen gelten für diesbezügliche mündliche Mitteilungen entsprechend.



CONFIDENTIAL AND PROPRIETARY
This information carrier and the information it contains are the property of Continental Teves AG & Co. oHG (TEVES). Any reproduction, disclosure or use of either is prohibited without the prior written consent of TEVES. TEVES reserve worldwide all rights also in case of industrial property rights being granted. The same provisions apply to any oral communications related thereto accordingly.

PROPERTY OF CONTINENTAL TEVES AG & CO. OHG
ALL RIGHTS RESERVED



Customer Product Specification
MK25 Safety Concept
TOYOTA 532N ABS/EBD/BTRAC/ETRAC/VSC/HBA

ATE N 655 66.14
Sheet 152
Page 104 of 206

ALLE RECHTE VORBEHALTEN

EIGENTUM DER CONTINENTAL TEVES AG & CO. OHG

VERTRAULICH

Dieser Informationsträger und die darin enthaltenen Informationen sind Eigentum von Continental Teves AG & Co. oHG (TEVES). Jegliche Vervielfältigung, Offenbarung oder Benutzung dieser Informationen ist ohne vorherige schriftliche Zustimmung von TEVES verboten. TEVES behält sich weltweit alle Rechte auch für den Fall der Erteilung von gewerblichen Schutzrechten vor. Die gleichen Regelungen gelten für diesbezügliche mündliche Mitteilungen entsprechend.



CONFIDENTIAL AND PROPRIETARY
This information carrier and the information it contains are the property of Continental Teves AG & Co. oHG (TEVES). Any reproduction, disclosure or use of either is prohibited without the prior written consent of TEVES. TEVES reserve worldwide all rights also in case of industrial property rights being granted. The same provisions apply to any oral communications related thereto accordingly.

PROPERTY OF CONTINENTAL TEVES AG & CO. OHG

ALL RIGHTS RESERVED



Customer Product Specification
MK25 Safety Concept
TOYOTA 532N ABS/EBD/BTRAC/ETRAC/VSC/HBA

ATE N 655 66.14
Sheet 152
Page 105 of 206

ALLE RECHTE VORBEHALTEN

EIGENTUM DER CONTINENTAL TEVES AG & CO. OHG

VERTRAULICH

Dieser Informationsträger und die darin enthaltenen Informationen sind Eigentum von Continental Teves AG & Co. oHG (TEVES). Jegliche Vervielfältigung, Offenbarung oder Benutzung dieser Informationen ist ohne vorherige schriftliche Zustimmung von TEVES verboten. TEVES behält sich weltweit alle Rechte auch für den Fall der Erteilung von gewerblichen Schutzrechten vor. Die gleichen Regelungen gelten für diesbezügliche mündliche Mitteilungen entsprechend.

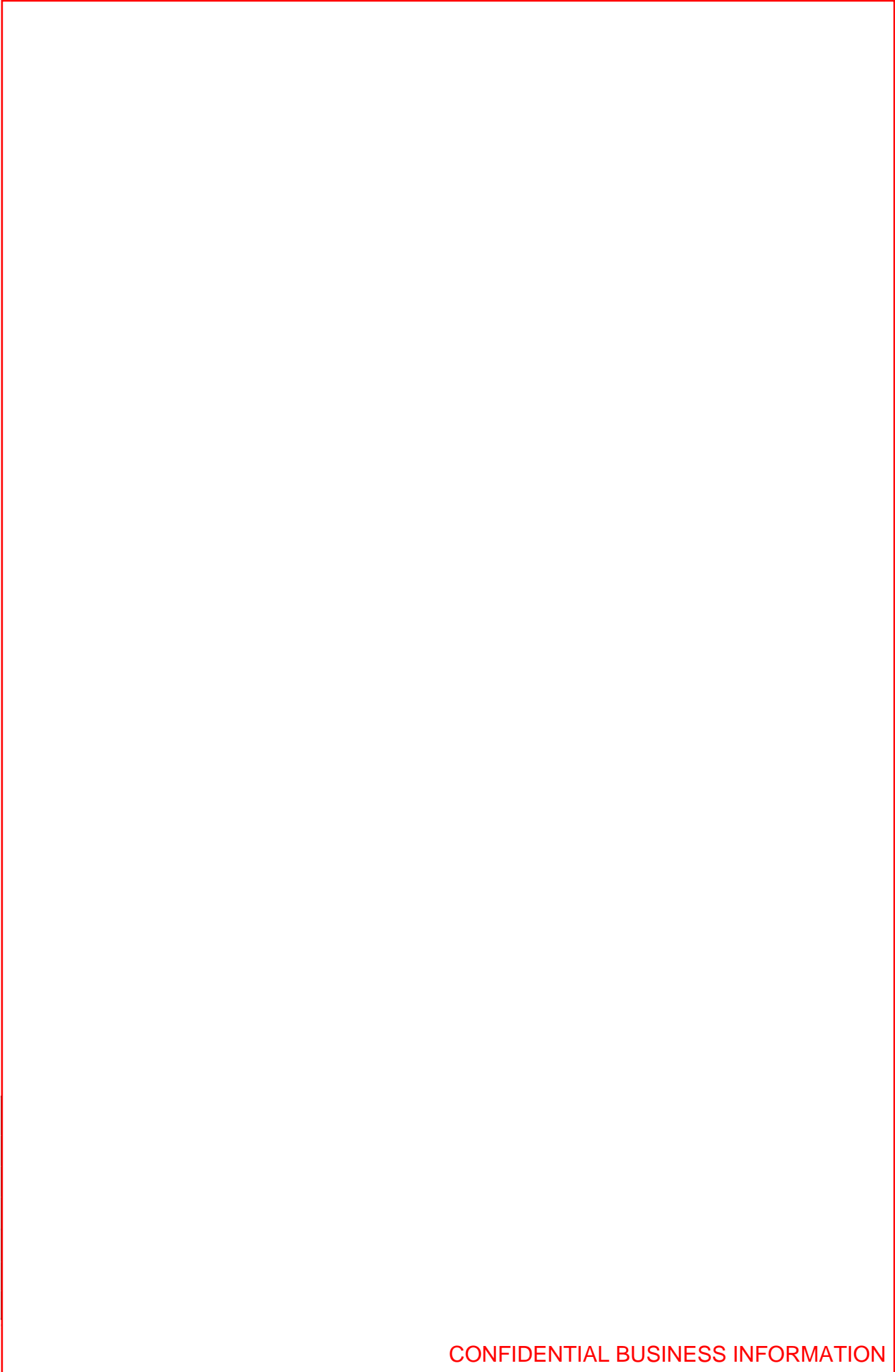

CONFIDENTIAL AND PROPRIETARY
This information carrier and the information it contains are the property of Continental Teves AG & Co. oHG (TEVES). Any reproduction, disclosure or use of either is prohibited without the prior written consent of TEVES. TEVES reserve worldwide all rights also in case of industrial property rights being granted. The same provisions apply to any oral communications related thereto accordingly.

PROPERTY OF CONTINENTAL TEVES AG & CO. OHG
ALL RIGHTS RESERVED

	<p>Customer Product Specification MK25 Safety Concept TOYOTA 532N ABS/EBD/BTRAC/ETRAC/VSC/HBA</p>	<p>ATE N 655 66.14 Sheet 152 Page 106 of 206</p>
--	---	--

ALLE RECHTE VORBEHALTEN

EIGENTUM DER CONTINENTAL TEVES AG & CO. OHG

VERTRAULICH

Dieser Informationsträger und die darin enthaltenen Informationen sind Eigentum von Continental Teves AG & Co. oHG (TEVES). Jegliche Vervielfältigung, Offenbarung oder Benutzung dieser Informationen ist ohne vorherige schriftliche Zustimmung von TEVES verboten. TEVES behält sich weltweit alle Rechte auch für den Fall der Erteilung von gewerblichen Schutzrechten vor. Die gleichen Regelungen gelten für diesbezügliche mündliche Mitteilungen entsprechend.

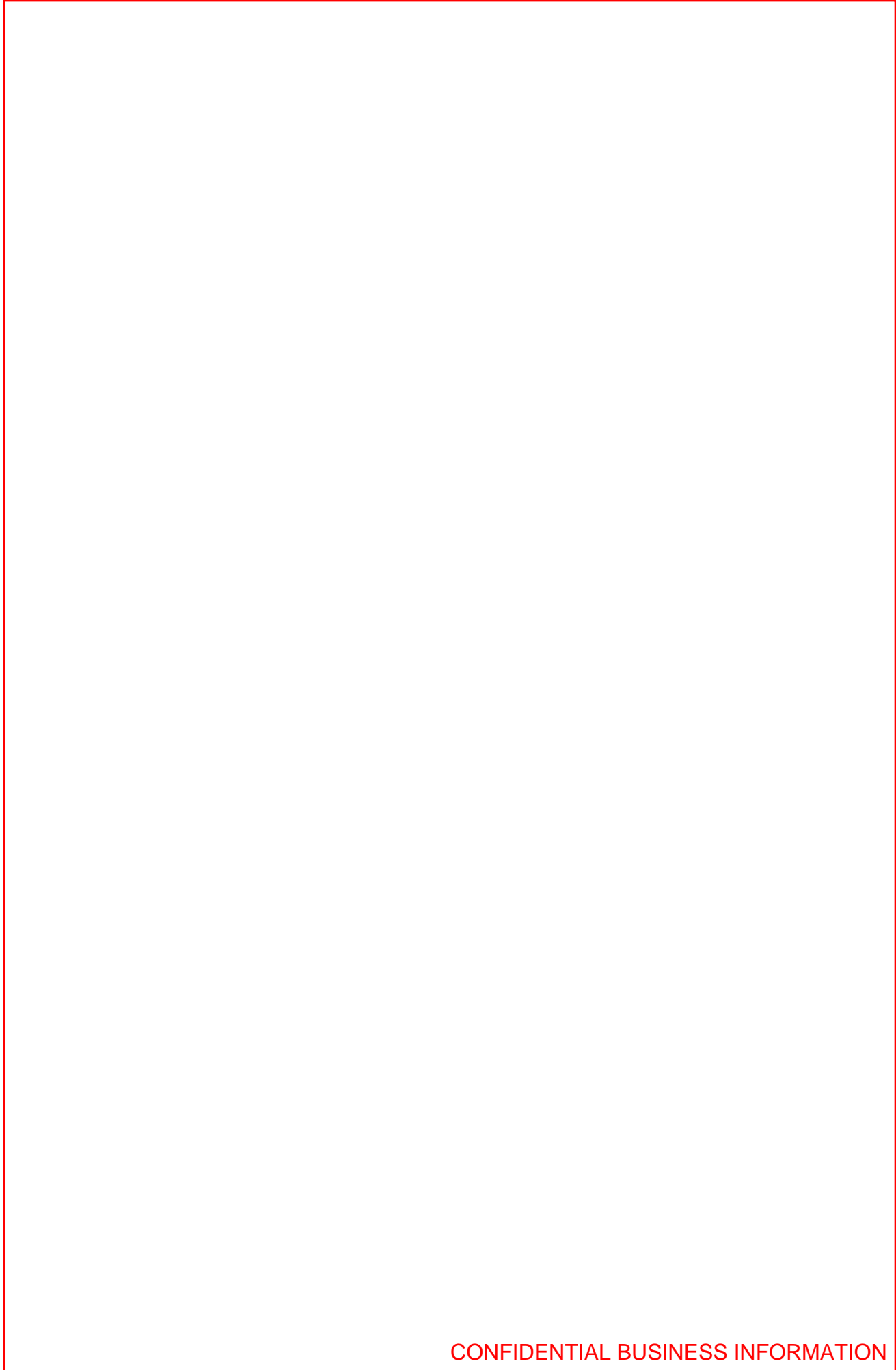

CONFIDENTIAL AND PROPRIETARY
 This information carrier and the information it contains are the property of Continental Teves AG & Co. oHG (TEVES). Any reproduction, disclosure or use of either is prohibited without the prior written consent of TEVES. TEVES reserve worldwide all rights also in case of industrial property rights being granted. The same provisions apply to any oral communications related thereto accordingly.

PROPERTY OF CONTINENTAL TEVES AG & CO. OHG
 ALL RIGHTS RESERVED



Customer Product Specification
MK25 Safety Concept
TOYOTA 532N ABS/EBD/BTRAC/ETRAC/VSC/HBA

ATE N 655 66.14
Sheet 152
Page 107 of 206

ALLE RECHTE VORBEHALTEN

EIGENTUM DER CONTINENTAL TEVES AG & CO. OHG

VERTRAULICH

Dieser Informationsträger und die darin enthaltenen Informationen sind Eigentum von Continental Teves AG & Co. oHG (TEVES). Jegliche Vervielfältigung, Offenbarung oder Benutzung dieser Informationen ist ohne vorherige schriftliche Zustimmung von TEVES verboten. TEVES behält sich weltweit alle Rechte auch für den Fall der Erteilung von gewerblichen Schutzrechten vor. Die gleichen Regelungen gelten für diesbezügliche mündliche Mitteilungen entsprechend.



CONFIDENTIAL AND PROPRIETARY

This information carrier and the information it contains are the property of Continental Teves AG & Co. oHG (TEVES). Any reproduction, disclosure or use of either is prohibited without the prior written consent of TEVES. TEVES reserve worldwide all rights also in case of industrial property rights being granted. The same provisions apply to any oral communications related thereto accordingly.

ALL RIGHTS RESERVED



Customer Product Specification
MK25 Safety Concept
TOYOTA 532N ABS/EBD/BTRAC/ETRAC/VSC/HBA

ATE N 655 66.14
Sheet 152
Page 108 of 206

ALLE RECHTE VORBEHALTEN

EIGENTUM DER CONTINENTAL TEVES AG & CO. OHG

VERTRAULICH

Dieser Informationsträger und die darin enthaltenen Informationen sind Eigentum von Continental Teves AG & Co. oHG (TEVES). Jegliche Vervielfältigung, Offenbarung oder Benutzung dieser Informationen ist ohne vorherige schriftliche Zustimmung von TEVES verboten. TEVES behält sich weltweit alle Rechte auch für den Fall der Erteilung von gewerblichen Schutzrechten vor. Die gleichen Regelungen gelten für diesbezügliche mündliche Mitteilungen entsprechend.

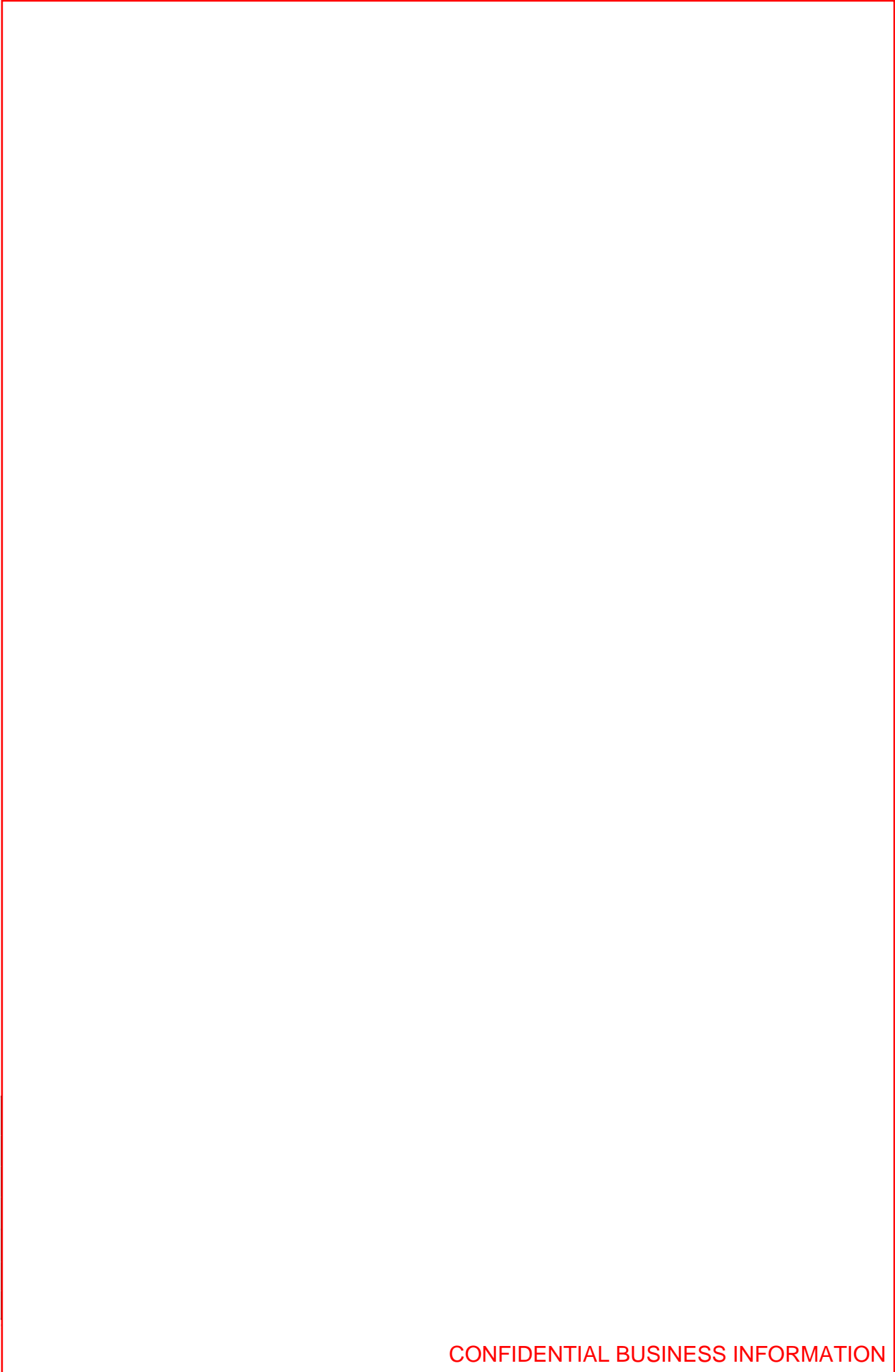

CONFIDENTIAL AND PROPRIETARY
This information carrier and the information it contains are the property of Continental Teves AG & Co. oHG (TEVES). Any reproduction, disclosure or use of either is prohibited without the prior written consent of TEVES. TEVES reserve worldwide all rights also in case of industrial property rights being granted. The same provisions apply to any oral communications related thereto accordingly.

PROPERTY OF CONTINENTAL TEVES AG & CO. OHG
ALL RIGHTS RESERVED



Customer Product Specification
MK25 Safety Concept
TOYOTA 532N ABS/EBD/BTRAC/ETRAC/VSC/HBA

ATE N 655 66.14
Sheet 152
Page 109 of 206

ALLE RECHTE VORBEHALTEN

EIGENTUM DER CONTINENTAL TEVES AG & CO. OHG

VERTRAULICH

Dieser Informationsträger und die darin enthaltenen Informationen sind Eigentum von Continental Teves AG & Co. oHG (TEVES). Jegliche Vervielfältigung, Offenbarung oder Benutzung dieser Informationen ist ohne vorherige schriftliche Zustimmung von TEVES verboten. TEVES behält sich weltweit alle Rechte auch für den Fall der Erteilung von gewerblichen Schutzrechten vor. Die gleichen Regelungen gelten für diesbezügliche mündliche Mitteilungen entsprechend.

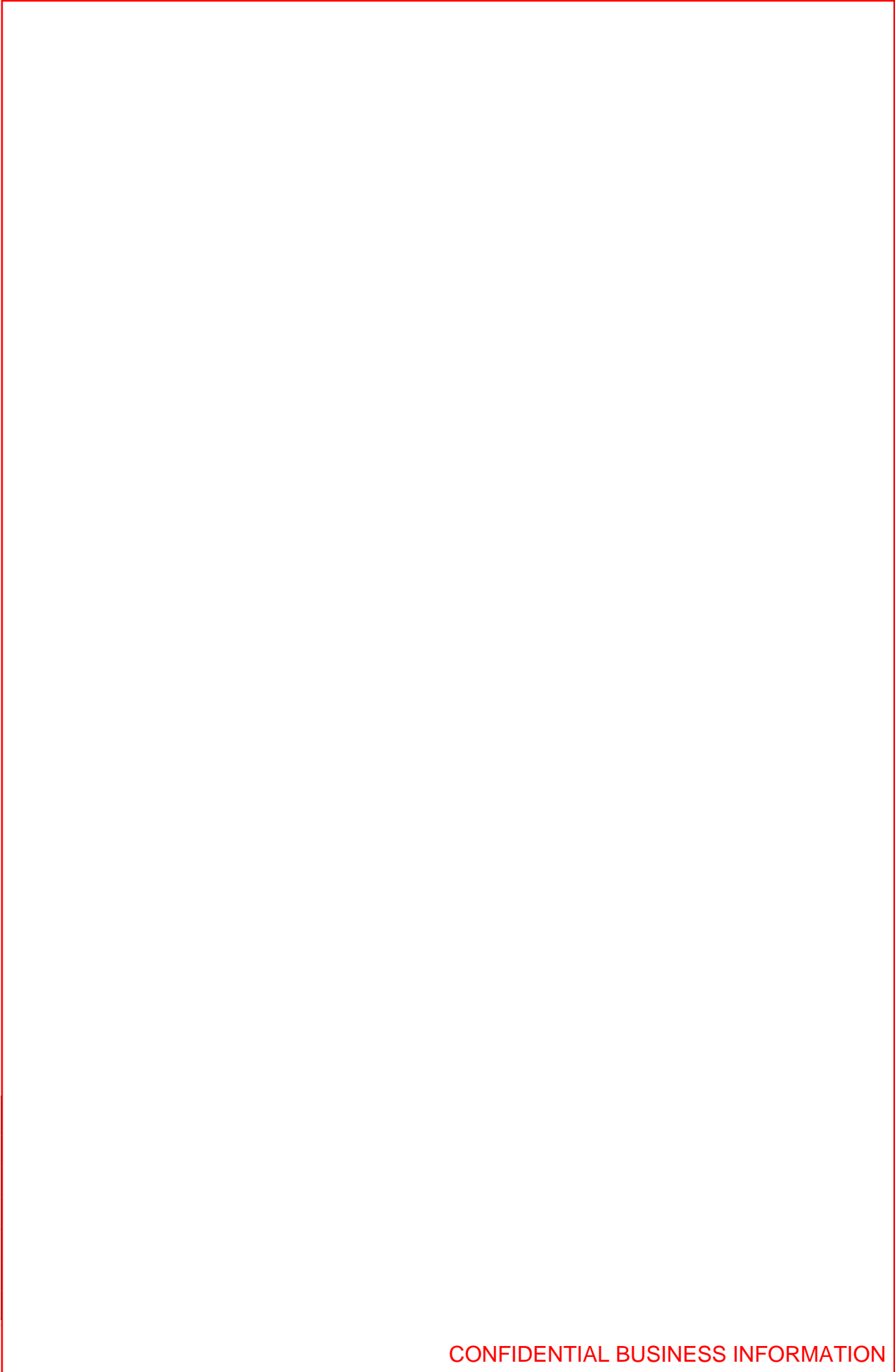

CONFIDENTIAL AND PROPRIETARY
This information carrier and the information it contains are the property of Continental Teves AG & Co. oHG (TEVES). Any reproduction, disclosure or use of either is prohibited without the prior written consent of TEVES. TEVES reserve worldwide all rights also in case of industrial property rights being granted. The same provisions apply to any oral communications related thereto accordingly.



Customer Product Specification
MK25 Safety Concept
TOYOTA 532N ABS/EBD/BTRAC/ETRAC/VSC/HBA

ATE N 655 66.14
Sheet 152
Page 110 of 206

ALLE RECHTE VORBEHALTEN

EIGENTUM DER CONTINENTAL TEVES AG & CO. OHG

VERTRAULICH

Dieser Informationsträger und die darin enthaltenen Informationen sind Eigentum von Continental Teves AG & Co. oHG (TEVES). Jegliche Vervielfältigung, Offenbarung oder Benutzung dieser Informationen ist ohne vorherige schriftliche Zustimmung von TEVES verboten. TEVES behält sich weltweit alle Rechte auch für den Fall der Erteilung von gewerblichen Schutzrechten vor. Die gleichen Regelungen gelten für diesbezügliche mündliche Mitteilungen entsprechend.





Customer Product Specification
MK25 Safety Concept
TOYOTA 532N ABS/EBD/BTRAC/ETRAC/VSC/HBA

ATE N 655 66.14
Sheet 152
Page 111 of 206

ALLE RECHTE VORBEHALTEN

EIGENTUM DER CONTINENTAL TEVES AG & CO. OHG

VERTRAULICH

Dieser Informationsträger und die darin enthaltenen Informationen sind Eigentum von Continental Teves AG & Co. oHG (TEVES). Jegliche Vervielfältigung, Offenbarung oder Benutzung dieser Informationen ist ohne vorherige schriftliche Zustimmung von TEVES verboten. TEVES behält sich weltweit alle Rechte auch für den Fall der Erteilung von gewerblichen Schutzrechten vor. Die gleichen Regelungen gelten für diesbezügliche mündliche Mitteilungen entsprechend.

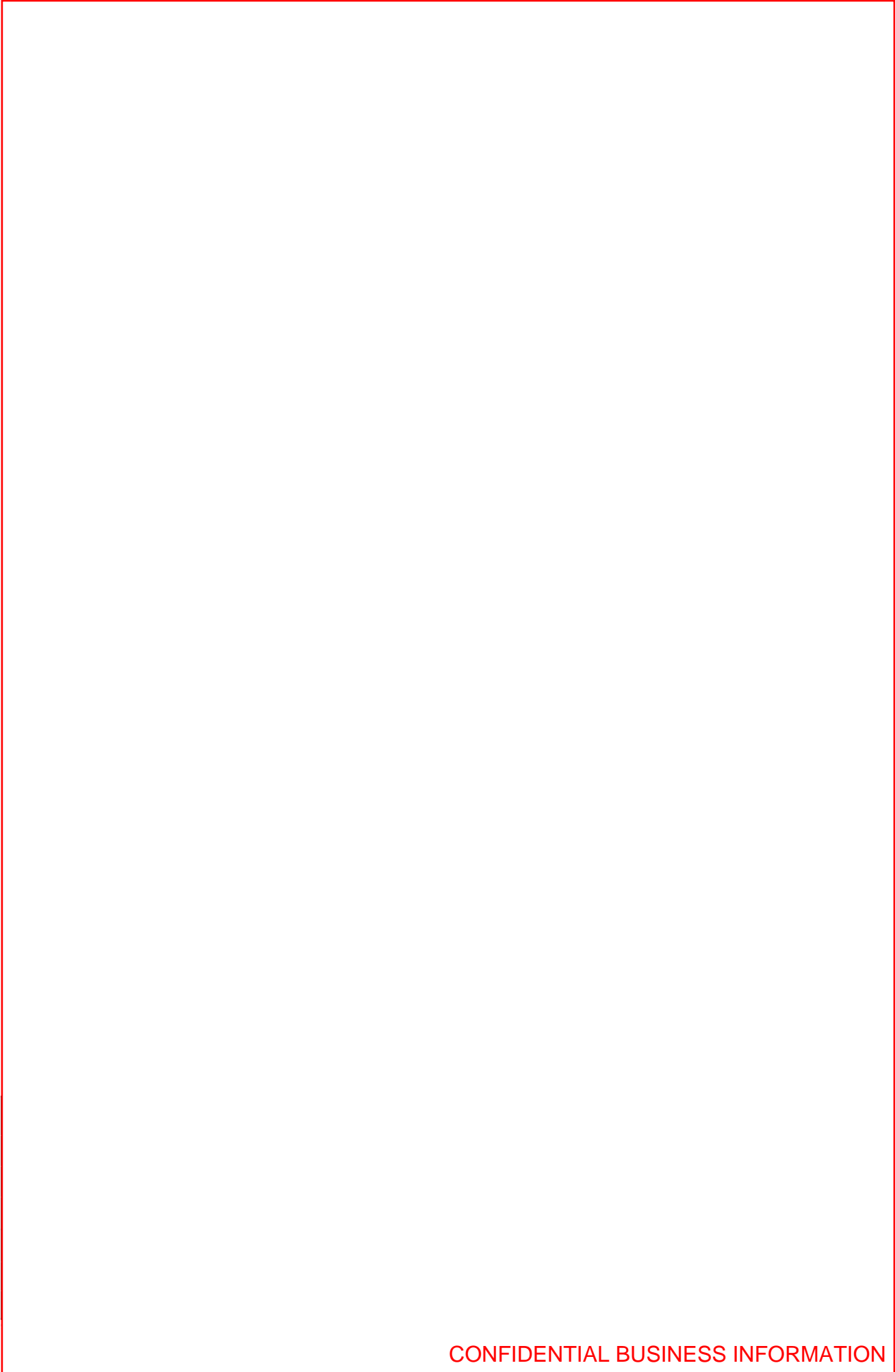



Customer Product Specification
MK25 Safety Concept
TOYOTA 532N ABS/EBD/BTRAC/ETRAC/VSC/HBA

ATE N 655 66.14
Sheet 152
Page 112 of 206

ALLE RECHTE VORBEHALTEN

EIGENTUM DER CONTINENTAL TEVES AG & CO. OHG

VERTRAULICH

Dieser Informationsträger und die darin enthaltenen Informationen sind Eigentum von Continental Teves AG & Co. oHG (TEVES). Jegliche Vervielfältigung, Offenbarung oder Benutzung dieser Informationen ist ohne vorherige schriftliche Zustimmung von TEVES verboten. TEVES behält sich weltweit alle Rechte auch für den Fall der Erteilung von gewerblichen Schutzrechten vor. Die gleichen Regelungen gelten für diesbezügliche mündliche Mitteilungen entsprechend.





Customer Product Specification
MK25 Safety Concept
TOYOTA 532N ABS/EBD/BTRAC/ETRAC/VSC/HBA

ATE N 655 66.14
Sheet 152
Page 113 of 206

ALLE RECHTE VORBEHALTEN

EIGENTUM DER CONTINENTAL TEVES AG & CO. OHG

VERTRAULICH

Dieser Informationsträger und die darin enthaltenen Informationen sind Eigentum von Continental Teves AG & Co. oHG (TEVES). Jegliche Vervielfältigung, Offenbarung oder Benutzung dieser Informationen ist ohne vorherige schriftliche Zustimmung von TEVES verboten. TEVES behält sich weltweit alle Rechte auch für den Fall der Erteilung von gewerblichen Schutzrechten vor. Die gleichen Regelungen gelten für diesbezügliche mündliche Mitteilungen entsprechend.

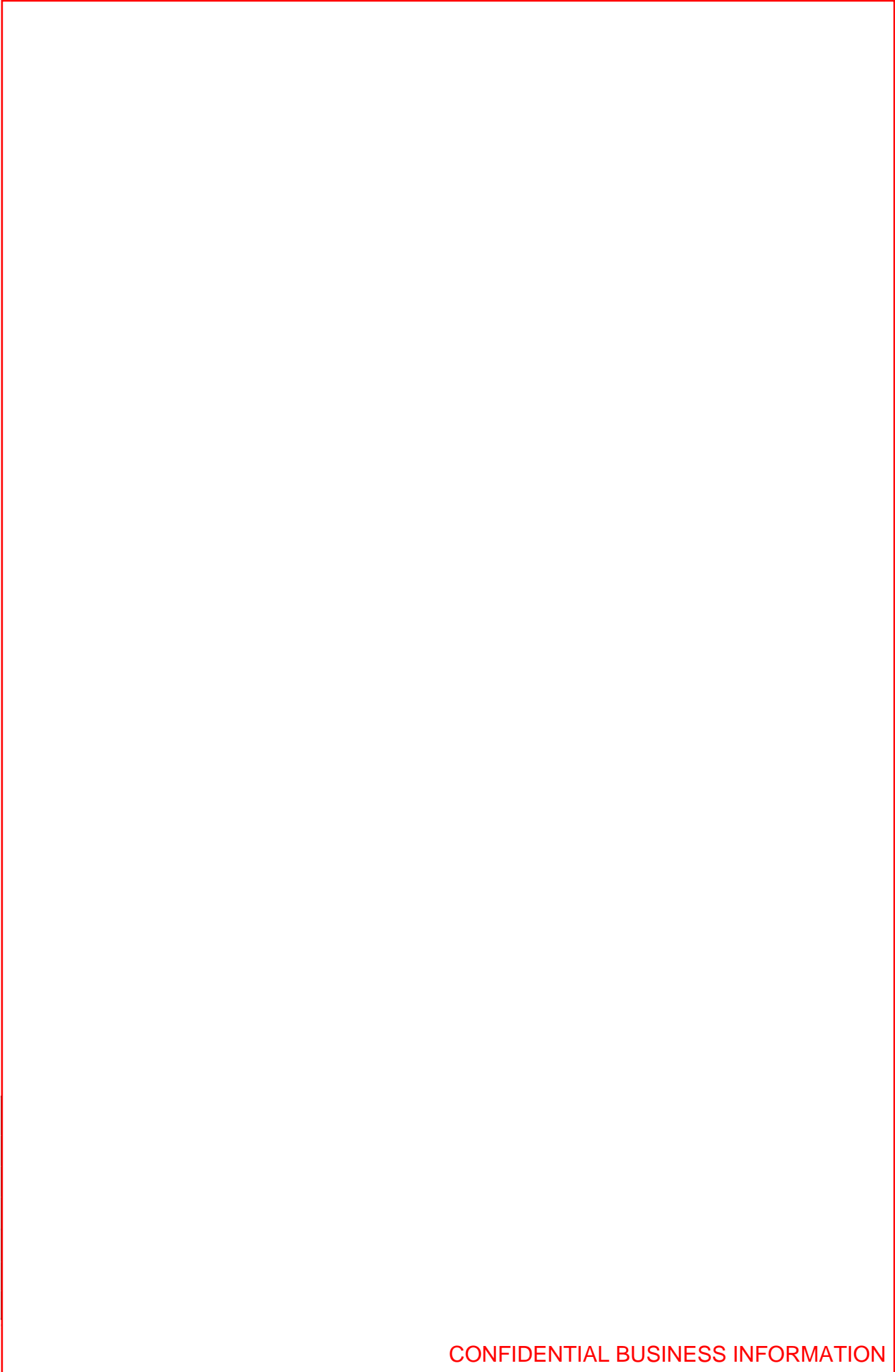

CONFIDENTIAL AND PROPRIETARY
This information carrier and the information it contains are the property of Continental Teves AG & Co. oHG (TEVES). Any reproduction, disclosure or use of either is prohibited without the prior written consent of TEVES. TEVES reserve worldwide all rights also in case of industrial property rights being granted. The same provisions apply to any oral communications related thereto accordingly.

PROPERTY OF CONTINENTAL TEVES AG & CO. OHG

ALL RIGHTS RESERVED



Customer Product Specification
MK25 Safety Concept
TOYOTA 532N ABS/EBD/BTRAC/ETRAC/VSC/HBA

ATE N 655 66.14
Sheet 152
Page 114 of 206

ALLE RECHTE VORBEHALTEN

EIGENTUM DER CONTINENTAL TEVES AG & CO. OHG

VERTRAULICH

Dieser Informationsträger und die darin enthaltenen Informationen sind Eigentum von Continental Teves AG & Co. oHG (TEVES). Jegliche Vervielfältigung, Offenbarung oder Benutzung dieser Informationen ist ohne vorherige schriftliche Zustimmung von TEVES verboten. TEVES behält sich weltweit alle Rechte auch für den Fall der Erteilung von gewerblichen Schutzrechten vor. Die gleichen Regelungen gelten für diesbezügliche mündliche Mitteilungen entsprechend.



CONFIDENTIAL AND PROPRIETARY
This information carrier and the information it contains are the property of Continental Teves AG & Co. oHG (TEVES). Any reproduction, disclosure or use of either is prohibited without the prior written consent of TEVES. TEVES reserve worldwide all rights also in case of industrial property rights being granted. The same provisions apply to any oral communications related thereto accordingly.



Customer Product Specification
MK25 Safety Concept
TOYOTA 532N ABS/EBD/BTRAC/ETRAC/VSC/HBA

ATE N 655 66.14
Sheet 152
Page 115 of 206

ALLE RECHTE VORBEHALTEN

EIGENTUM DER CONTINENTAL TEVES AG & CO. OHG

VERTRAULICH

Dieser Informationsträger und die darin enthaltenen Informationen sind Eigentum von Continental Teves AG & Co. oHG (TEVES). Jegliche Vervielfältigung, Offenbarung oder Benutzung dieser Informationen ist ohne vorherige schriftliche Zustimmung von TEVES verboten. TEVES behält sich weltweit alle Rechte auch für den Fall der Erteilung von gewerblichen Schutzrechten vor. Die gleichen Regelungen gelten für diesbezügliche mündliche Mitteilungen entsprechend.



CONFIDENTIAL AND PROPRIETARY
This information carrier and the information it contains are the property of Continental Teves AG & Co. oHG (TEVES). Any reproduction, disclosure or use of either is prohibited without the prior written consent of TEVES. TEVES reserve worldwide all rights also in case of industrial property rights being granted. The same provisions apply to any oral communications related thereto accordingly.



Customer Product Specification
MK25 Safety Concept
TOYOTA 532N ABS/EBD/BTRAC/ETRAC/VSC/HBA

ATE N 655 66.14
Sheet 152
Page 116 of 206

ALLE RECHTE VORBEHALTEN

EIGENTUM DER CONTINENTAL TEVES AG & CO. OHG

VERTRAULICH

Dieser Informationsträger und die darin enthaltenen Informationen sind Eigentum von Continental Teves AG & Co. oHG (TEVES). Jegliche Vervielfältigung, Offenbarung oder Benutzung dieser Informationen ist ohne vorherige schriftliche Zustimmung von TEVES verboten. TEVES behält sich weltweit alle Rechte auch für den Fall der Erteilung von gewerblichen Schutzrechten vor. Die gleichen Regelungen gelten für diesbezügliche mündliche Mitteilungen entsprechend.

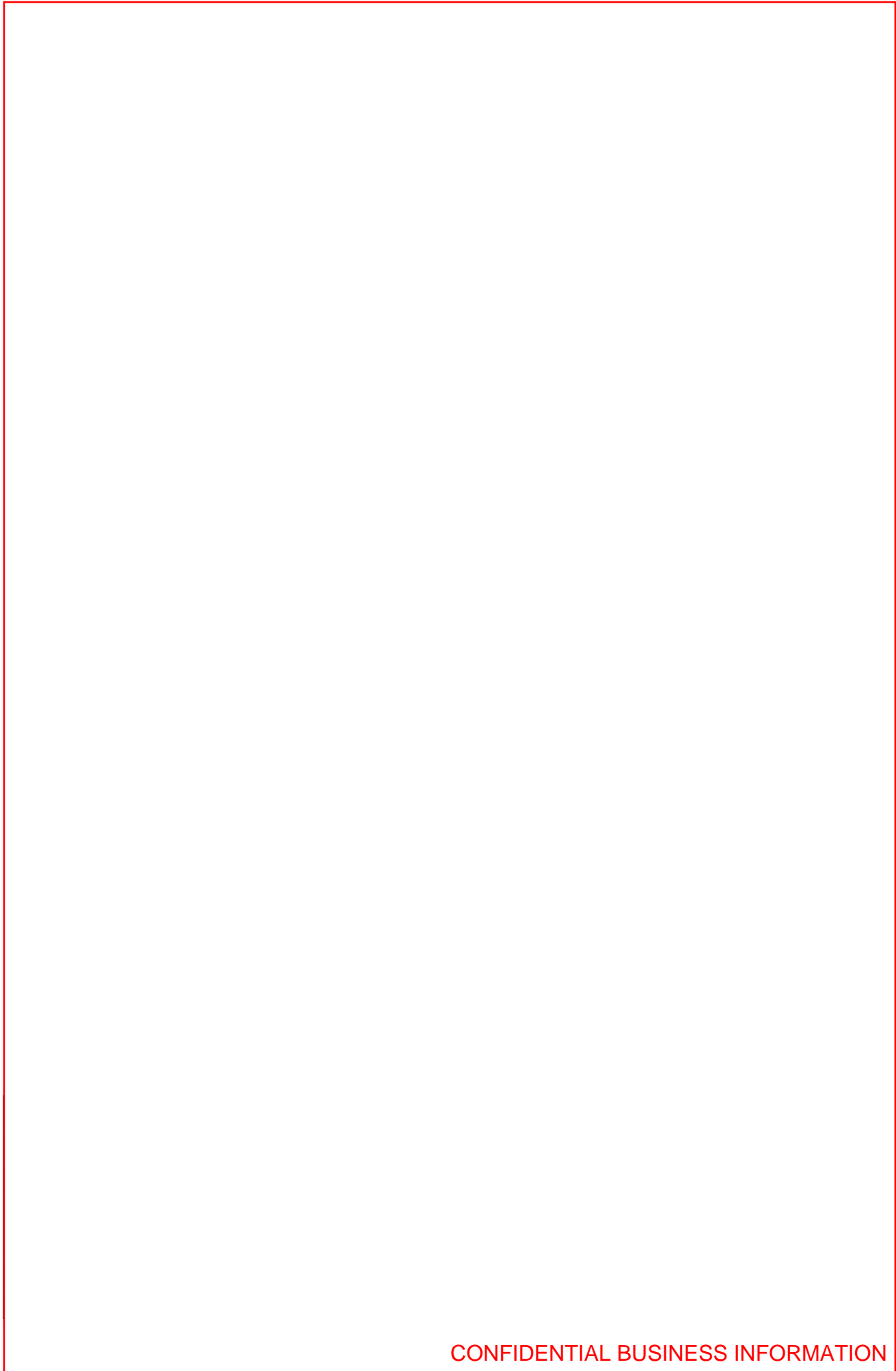



Customer Product Specification
MK25 Safety Concept
TOYOTA 532N ABS/EBD/BTRAC/ETRAC/VSC/HBA

ATE N 655 66.14
Sheet 152
Page 117 of 206

ALLE RECHTE VORBEHALTEN

EIGENTUM DER CONTINENTAL TEVES AG & CO. OHG

VERTRAULICH

Dieser Informationsträger und die darin enthaltenen Informationen sind Eigentum von Continental Teves AG & Co. oHG (TEVES). Jegliche Vervielfältigung, Offenbarung oder Benutzung dieser Informationen ist ohne vorherige schriftliche Zustimmung von TEVES verboten. TEVES behält sich weltweit alle Rechte auch für den Fall der Erteilung von gewerblichen Schutzrechten vor. Die gleichen Regelungen gelten für diesbezügliche mündliche Mitteilungen entsprechend.



CONFIDENTIAL AND PROPRIETARY
This information carrier and the information it contains are the property of Continental Teves AG & Co. oHG (TEVES). Any reproduction, disclosure or use of either is prohibited without the prior written consent of TEVES. TEVES reserve worldwide all rights also in case of industrial property rights being granted. The same provisions apply to any oral communications related thereto accordingly.



Customer Product Specification
MK25 Safety Concept
TOYOTA 532N ABS/EBD/BTRAC/ETRAC/VSC/HBA

ATE N 655 66.14
Sheet 152
Page 118 of 206

ALLE RECHTE VORBEHALTEN

EIGENTUM DER CONTINENTAL TEVES AG & CO. OHG

VERTRAULICH

Dieser Informationsträger und die darin enthaltenen Informationen sind Eigentum von Continental Teves AG & Co. oHG (TEVES). Jegliche Vervielfältigung, Offenbarung oder Benutzung dieser Informationen ist ohne vorherige schriftliche Zustimmung von TEVES verboten. TEVES behält sich weltweit alle Rechte auch für den Fall der Erteilung von gewerblichen Schutzrechten vor. Die gleichen Regelungen gelten für diesbezügliche mündliche Mitteilungen entsprechend.





Customer Product Specification
MK25 Safety Concept
TOYOTA 532N ABS/EBD/BTRAC/ETRAC/VSC/HBA

ATE N 655 66.14
Sheet 152
Page 119 of 206

ALLE RECHTE VORBEHALTEN

EIGENTUM DER CONTINENTAL TEVES AG & CO. OHG

VERTRAULICH

Dieser Informationsträger und die darin enthaltenen Informationen sind Eigentum von Continental Teves AG & Co. oHG (TEVES). Jegliche Vervielfältigung, Offenbarung oder Benutzung dieser Informationen ist ohne vorherige schriftliche Zustimmung von TEVES verboten. TEVES behält sich weltweit alle Rechte auch für den Fall der Erteilung von gewerblichen Schutzrechten vor. Die gleichen Regelungen gelten für diesbezügliche mündliche Mitteilungen entsprechend.

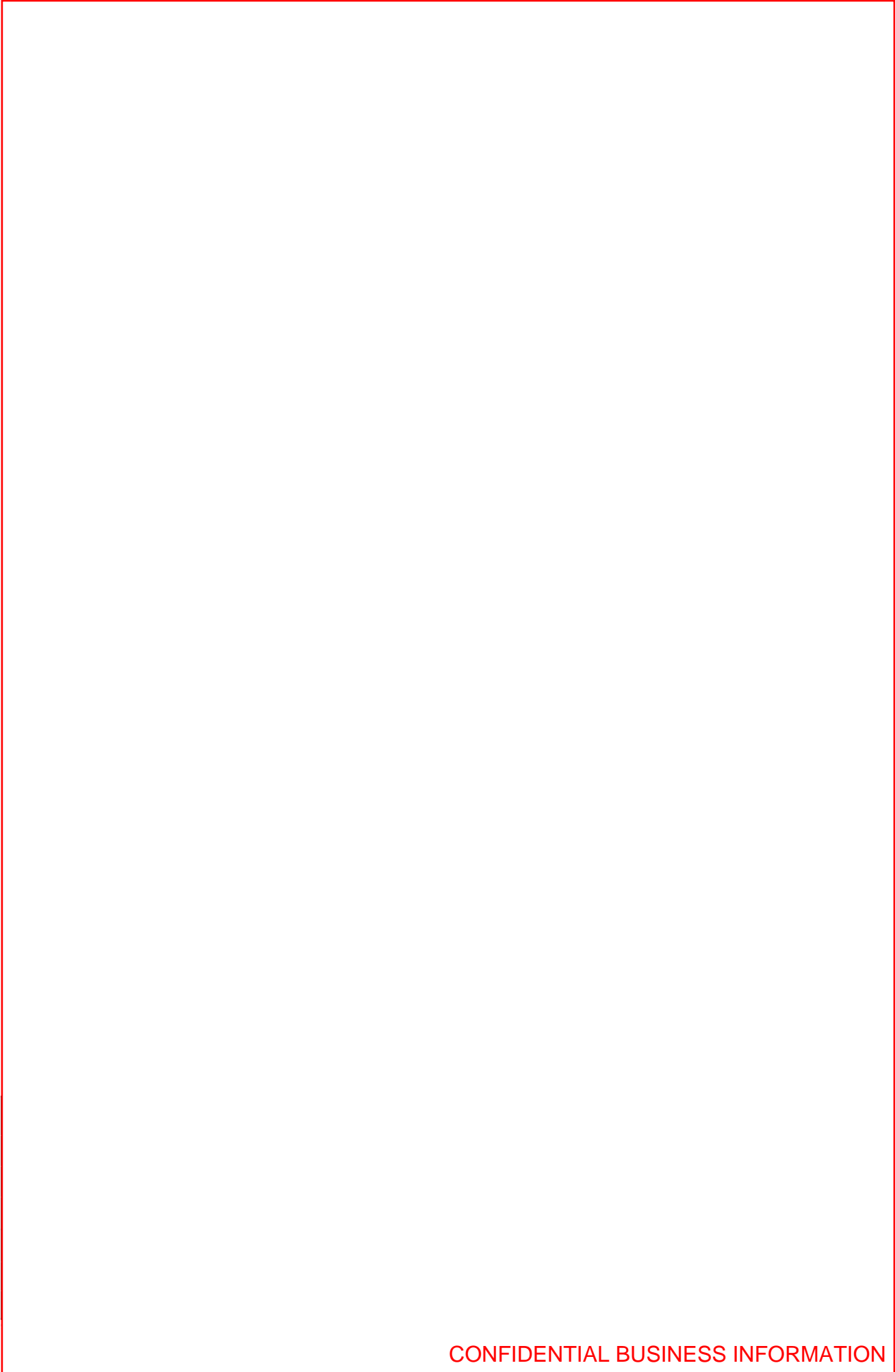

CONFIDENTIAL AND PROPRIETARY
This information carrier and the information it contains are the property of Continental Teves AG & Co. oHG (TEVES). Any reproduction, disclosure or use of either is prohibited without the prior written consent of TEVES. TEVES reserve worldwide all rights also in case of industrial property rights being granted. The same provisions apply to any oral communications related thereto accordingly.



Customer Product Specification
MK25 Safety Concept
TOYOTA 532N ABS/EBD/BTRAC/ETRAC/VSC/HBA

ATE N 655 66.14
Sheet 152
Page 120 of 206

ALLE RECHTE VORBEHALTEN

EIGENTUM DER CONTINENTAL TEVES AG & CO. OHG

VERTRAULICH

Dieser Informationsträger und die darin enthaltenen Informationen sind Eigentum von Continental Teves AG & Co. oHG (TEVES). Jegliche Vervielfältigung, Offenbarung oder Benutzung dieser Informationen ist ohne vorherige schriftliche Zustimmung von TEVES verboten. TEVES behält sich weltweit alle Rechte auch für den Fall der Erteilung von gewerblichen Schutzrechten vor. Die gleichen Regelungen gelten für diesbezügliche mündliche Mitteilungen entsprechend.



CONFIDENTIAL AND PROPRIETARY
This information carrier and the information it contains are the property of Continental Teves AG & Co. oHG (TEVES). Any reproduction, disclosure or use of either is prohibited without the prior written consent of TEVES. TEVES reserve worldwide all rights also in case of industrial property rights being granted. The same provisions apply to any oral communications related thereto accordingly.

	<p>Customer Product Specification MK25 Safety Concept TOYOTA 532N ABS/EBD/BTRAC/ETRAC/VSC/HBA</p>	<p>ATE N 655 66.14 Sheet 152 Page 121 of 206</p>
--	---	--

ALLE RECHTE VORBEHALTEN

EIGENTUM DER CONTINENTAL TEVES AG & CO. OHG

VERTRAULICH

Dieser Informationsträger und die darin enthaltenen Informationen sind Eigentum von Continental Teves AG & Co. oHG (TEVES). Jegliche Vervielfältigung, Offenbarung oder Benutzung dieser Informationen ist ohne vorherige schriftliche Zustimmung von TEVES verboten. TEVES behält sich weltweit alle Rechte auch für den Fall der Erteilung von gewerblichen Schutzrechten vor. Die gleichen Regelungen gelten für diesbezügliche mündliche Mitteilungen entsprechend.

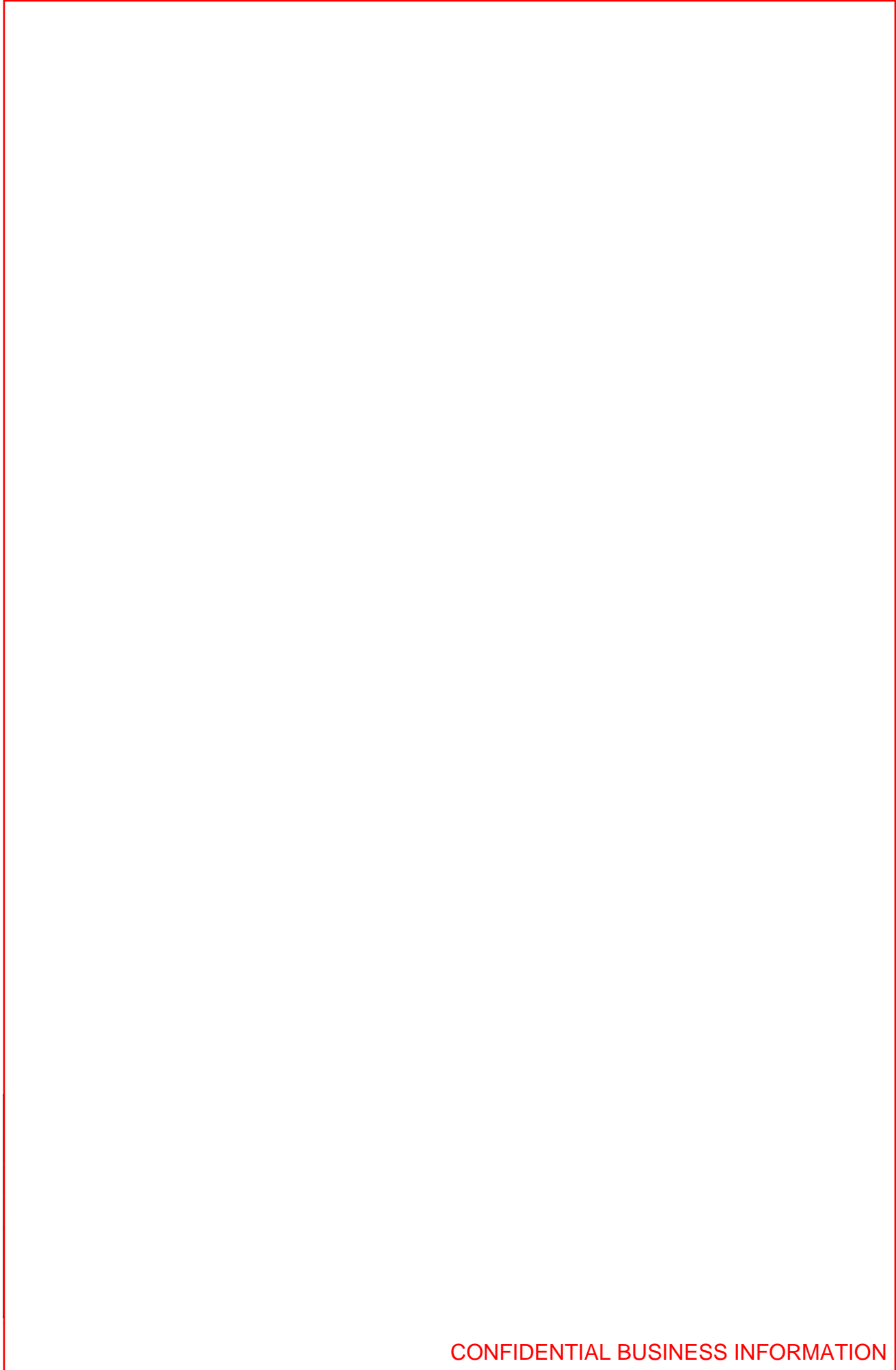

CONFIDENTIAL AND PROPRIETARY
 This information carrier and the information it contains are the property of Continental Teves AG & Co. oHG (TEVES). Any reproduction, disclosure or use of either is prohibited without the prior written consent of TEVES. TEVES reserve worldwide all rights also in case of industrial property rights being granted. The same provisions apply to any oral communications related thereto accordingly.

PROPERTY OF CONTINENTAL TEVES AG & CO. OHG
 ALL RIGHTS RESERVED



Customer Product Specification
MK25 Safety Concept
TOYOTA 532N ABS/EBD/BTRAC/ETRAC/VSC/HBA

ATE N 655 66.14
Sheet 152
Page 122 of 206

ALLE RECHTE VORBEHALTEN

EIGENTUM DER CONTINENTAL TEVES AG & CO. OHG

VERTRAULICH

Dieser Informationsträger und die darin enthaltenen Informationen sind Eigentum von Continental Teves AG & Co. oHG (TEVES). Jegliche Vervielfältigung, Offenbarung oder Benutzung dieser Informationen ist ohne vorherige schriftliche Zustimmung von TEVES verboten. TEVES behält sich weltweit alle Rechte auch für den Fall der Erteilung von gewerblichen Schutzrechten vor. Die gleichen Regelungen gelten für diesbezügliche mündliche Mitteilungen entsprechend.





Customer Product Specification
MK25 Safety Concept
TOYOTA 532N ABS/EBD/BTRAC/ETRAC/VSC/HBA

ATE N 655 66.14
Sheet 152
Page 123 of 206

ALLE RECHTE VORBEHALTEN

EIGENTUM DER CONTINENTAL TEVES AG & CO. OHG

VERTRAULICH

Dieser Informationsträger und die darin enthaltenen Informationen sind Eigentum von Continental Teves AG & Co. oHG (TEVES). Jegliche Vervielfältigung, Offenbarung oder Benutzung dieser Informationen ist ohne vorherige schriftliche Zustimmung von TEVES verboten. TEVES behält sich weltweit alle Rechte auch für den Fall der Erteilung von gewerblichen Schutzrechten vor. Die gleichen Regelungen gelten für diesbezügliche mündliche Mitteilungen entsprechend.

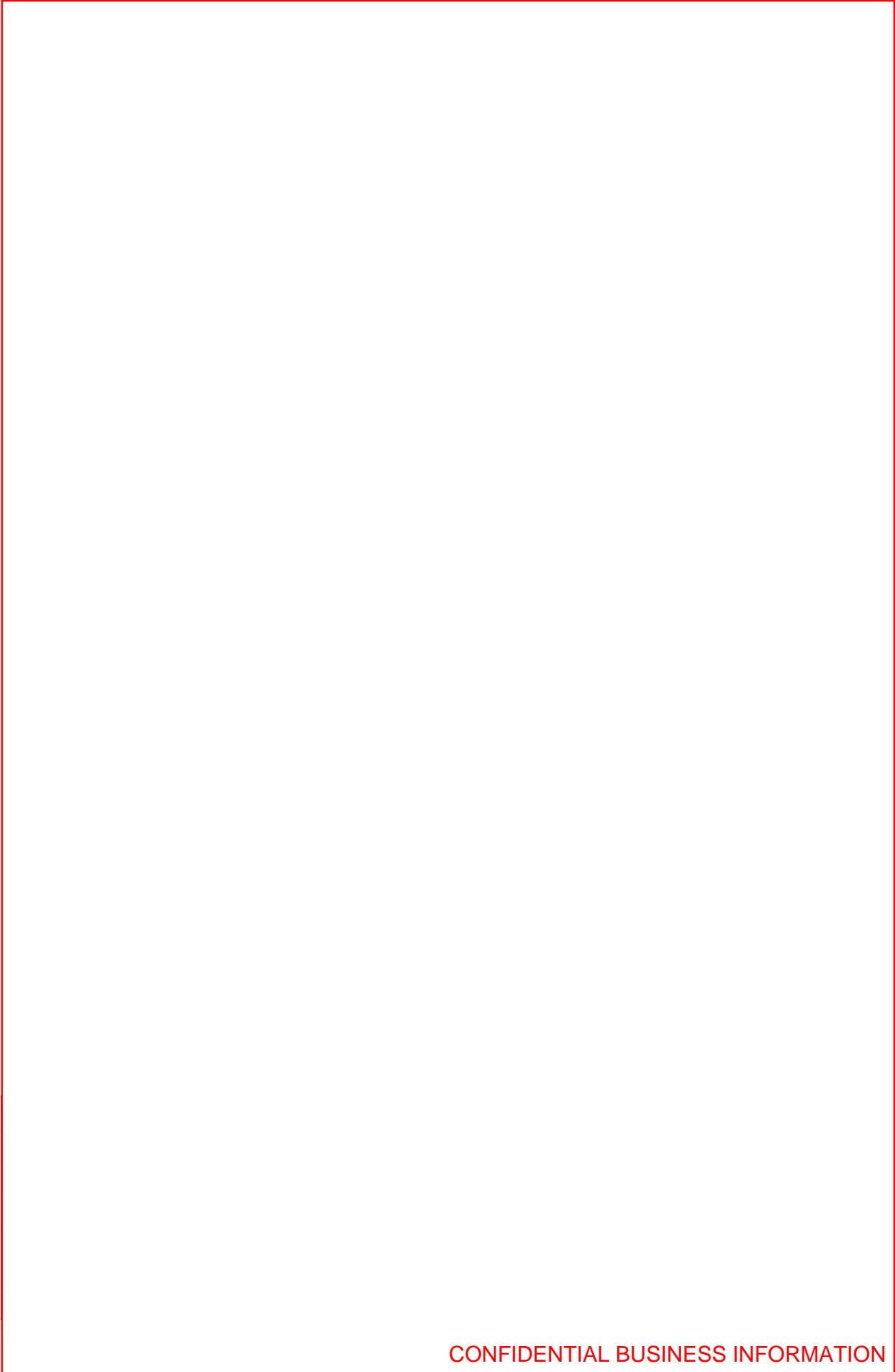

CONFIDENTIAL AND PROPRIETARY
This information carrier and the information it contains are the property of Continental Teves AG & Co. oHG (TEVES). Any reproduction, disclosure or use of either is prohibited without the prior written consent of TEVES. TEVES reserve worldwide all rights also in case of industrial property rights being granted. The same provisions apply to any oral communications related thereto accordingly.



Customer Product Specification
MK25 Safety Concept
TOYOTA 532N ABS/EBD/BTRAC/ETRAC/VSC/HBA

ATE N 655 66.14
Sheet 152
Page 124 of 206

ALLE RECHTE VORBEHALTEN

EIGENTUM DER CONTINENTAL TEVES AG & CO. OHG

VERTRAULICH

Dieser Informationsträger und die darin enthaltenen Informationen sind Eigentum von Continental Teves AG & Co. oHG (TEVES). Jegliche Vervielfältigung, Offenbarung oder Benutzung dieser Informationen ist ohne vorherige schriftliche Zustimmung von TEVES verboten. TEVES behält sich weltweit alle Rechte auch für den Fall der Erteilung von gewerblichen Schutzrechten vor. Die gleichen Regelungen gelten für diesbezügliche mündliche Mitteilungen entsprechend.





Customer Product Specification
MK25 Safety Concept
TOYOTA 532N ABS/EBD/BTRAC/ETRAC/VSC/HBA

ATE N 655 66.14
Sheet 152
Page 125 of 206

ALLE RECHTE VORBEHALTEN

EIGENTUM DER CONTINENTAL TEVES AG & CO. OHG

VERTRAULICH

Dieser Informationsträger und die darin enthaltenen Informationen sind Eigentum von Continental Teves AG & Co. oHG (TEVES). Jegliche Vervielfältigung, Offenbarung oder Benutzung dieser Informationen ist ohne vorherige schriftliche Zustimmung von TEVES verboten. TEVES behält sich weltweit alle Rechte auch für den Fall der Erteilung von gewerblichen Schutzrechten vor. Die gleichen Regelungen gelten für diesbezügliche mündliche Mitteilungen entsprechend.

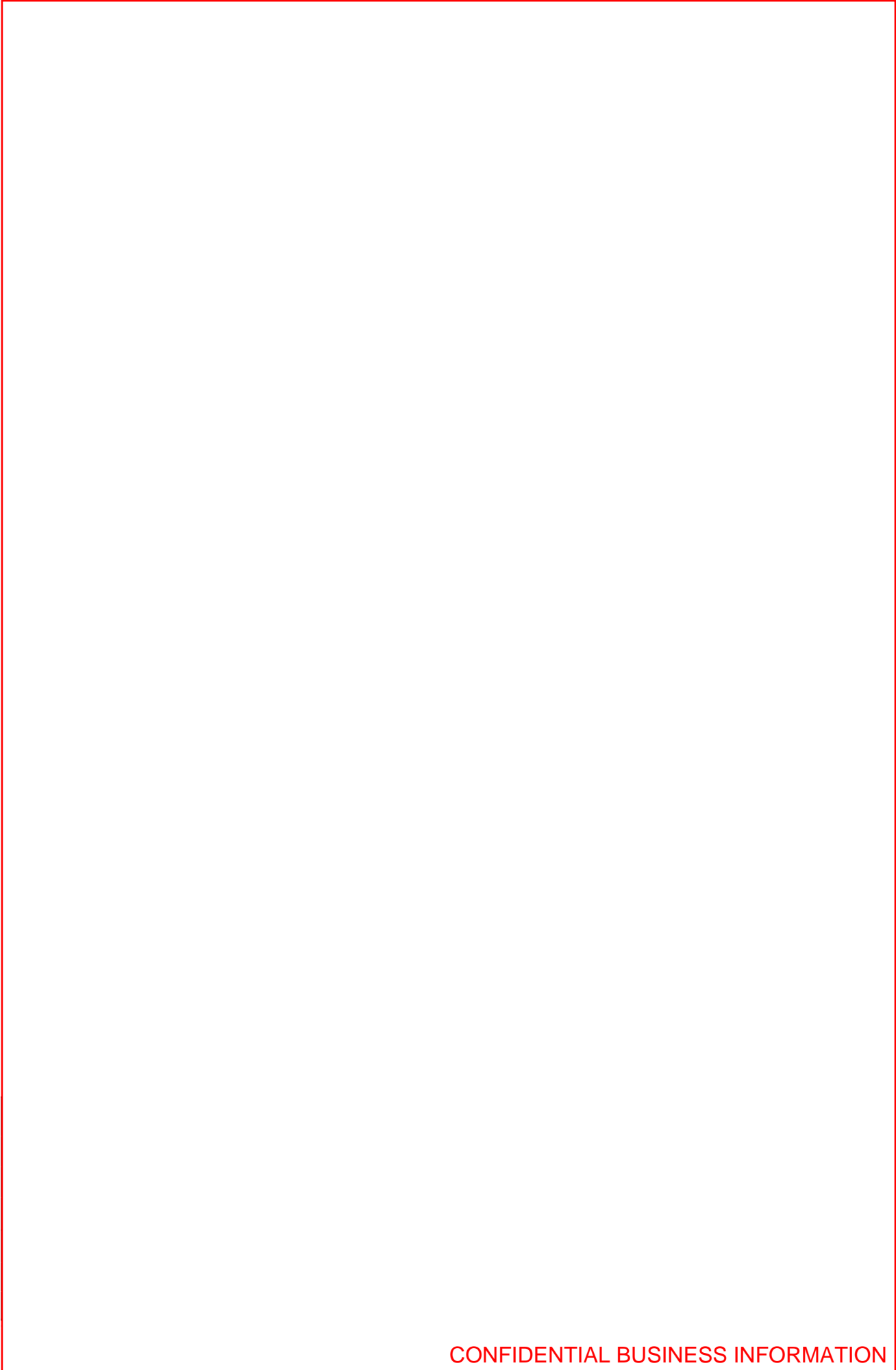



Customer Product Specification
MK25 Safety Concept
TOYOTA 532N ABS/EBD/BTRAC/ETRAC/VSC/HBA

ATE N 655 66.14
Sheet 152
Page 126 of 206

ALLE RECHTE VORBEHALTEN

EIGENTUM DER CONTINENTAL TEVES AG & CO. OHG

VERTRAULICH

Dieser Informationsträger und die darin enthaltenen Informationen sind Eigentum von Continental Teves AG & Co. oHG (TEVES). Jegliche Vervielfältigung, Offenbarung oder Benutzung dieser Informationen ist ohne vorherige schriftliche Zustimmung von TEVES verboten. TEVES behält sich weltweit alle Rechte auch für den Fall der Erteilung von gewerblichen Schutzrechten vor. Die gleichen Regelungen gelten für diesbezügliche mündliche Mitteilungen entsprechend.

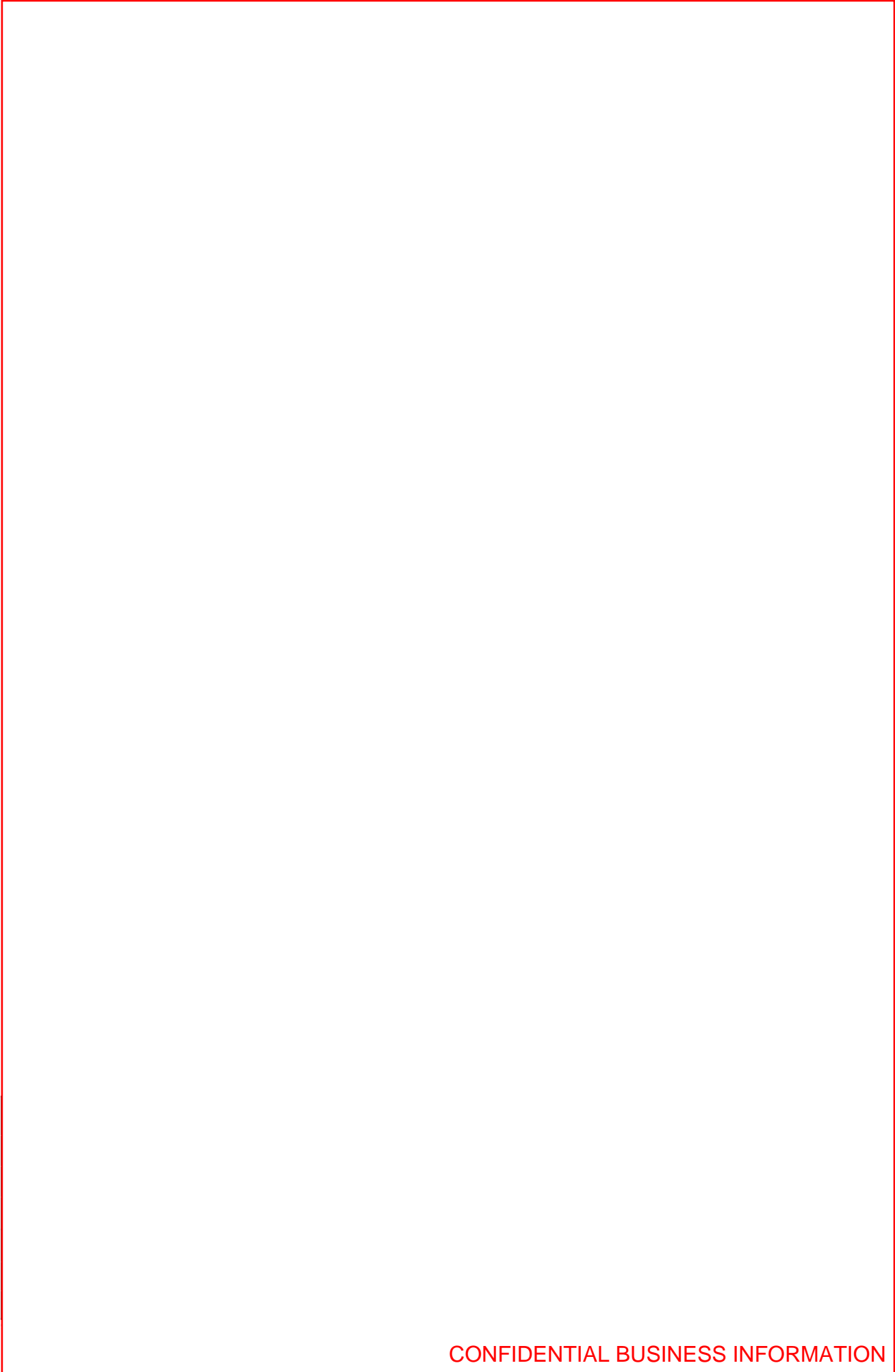



Customer Product Specification
MK25 Safety Concept
TOYOTA 532N ABS/EBD/BTRAC/ETRAC/VSC/HBA

ATE N 655 66.14
Sheet 152
Page 127 of 206

ALLE RECHTE VORBEHALTEN

EIGENTUM DER CONTINENTAL TEVES AG & CO. OHG

VERTRAULICH

Dieser Informationsträger und die darin enthaltenen Informationen sind Eigentum von Continental Teves AG & Co. oHG (TEVES). Jegliche Vervielfältigung, Offenbarung oder Benutzung dieser Informationen ist ohne vorherige schriftliche Zustimmung von TEVES verboten. TEVES behält sich weltweit alle Rechte auch für den Fall der Erteilung von gewerblichen Schutzrechten vor. Die gleichen Regelungen gelten für diesbezügliche mündliche Mitteilungen entsprechend.

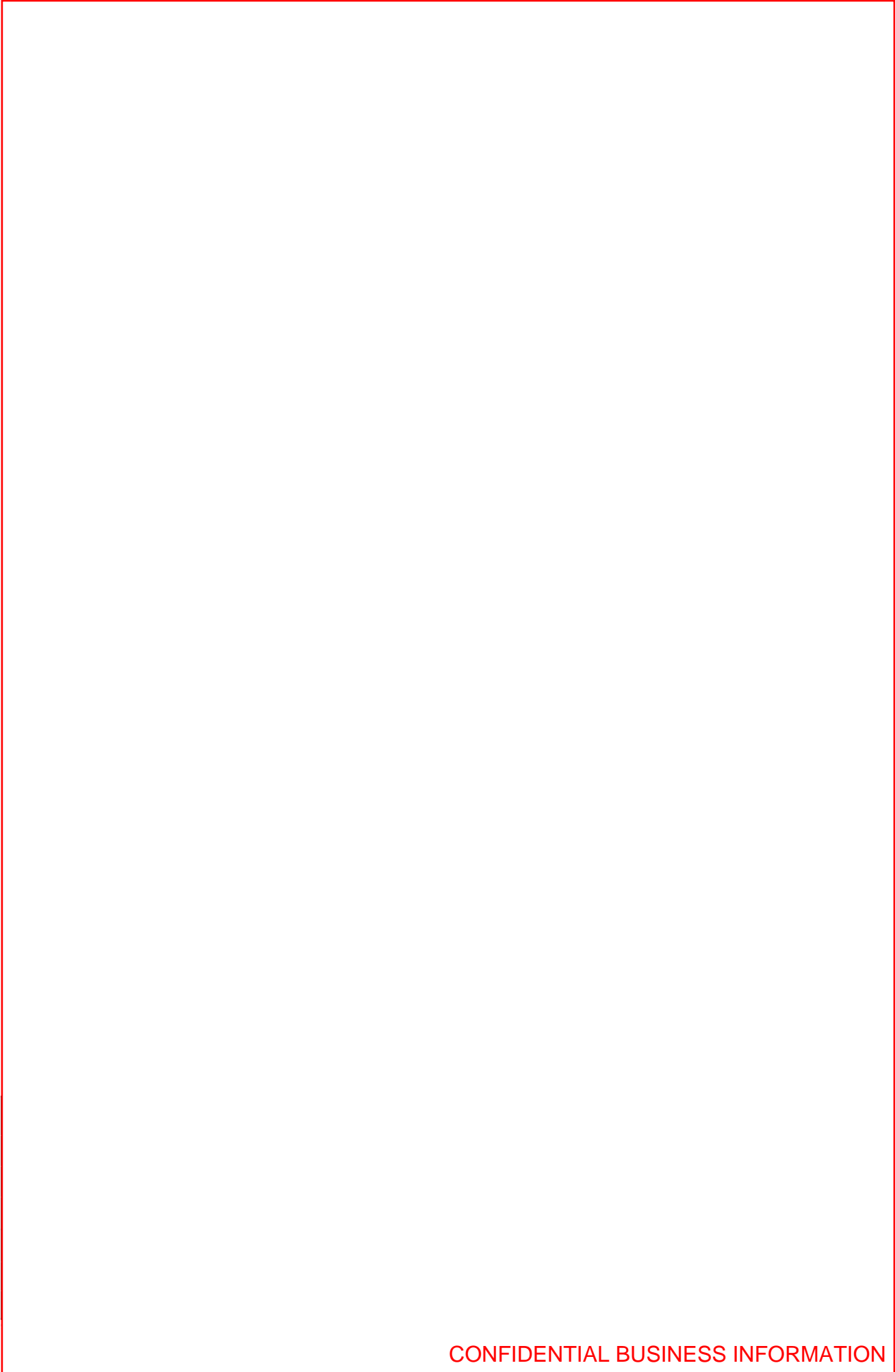



Customer Product Specification
MK25 Safety Concept
TOYOTA 532N ABS/EBD/BTRAC/ETRAC/VSC/HBA

ATE N 655 66.14
Sheet 152
Page 128 of 206

ALLE RECHTE VORBEHALTEN

EIGENTUM DER CONTINENTAL TEVES AG & CO. OHG

VERTRAULICH

Dieser Informationsträger und die darin enthaltenen Informationen sind Eigentum von Continental Teves AG & Co. oHG (TEVES). Jegliche Vervielfältigung, Offenbarung oder Benutzung dieser Informationen ist ohne vorherige schriftliche Zustimmung von TEVES verboten. TEVES behält sich weltweit alle Rechte auch für den Fall der Erteilung von gewerblichen Schutzrechten vor. Die gleichen Regelungen gelten für diesbezügliche mündliche Mitteilungen entsprechend.



CONFIDENTIAL AND PROPRIETARY
This information carrier and the information it contains are the property of Continental Teves AG & Co. oHG (TEVES). Any reproduction, disclosure or use of either is prohibited without the prior written consent of TEVES. TEVES reserve worldwide all rights also in case of industrial property rights being granted. The same provisions apply to any oral communications related thereto accordingly.



Customer Product Specification
MK25 Safety Concept
TOYOTA 532N ABS/EBD/BTRAC/ETRAC/VSC/HBA

ATE N 655 66.14
Sheet 152
Page 129 of 206

ALLE RECHTE VORBEHALTEN

EIGENTUM DER CONTINENTAL TEVES AG & CO. OHG

VERTRAULICH

Dieser Informationsträger und die darin enthaltenen Informationen sind Eigentum von Continental Teves AG & Co. oHG (TEVES). Jegliche Vervielfältigung, Offenbarung oder Benutzung dieser Informationen ist ohne vorherige schriftliche Zustimmung von TEVES verboten. TEVES behält sich weltweit alle Rechte auch für den Fall der Erteilung von gewerblichen Schutzrechten vor. Die gleichen Regelungen gelten für diesbezügliche mündliche Mitteilungen entsprechend.

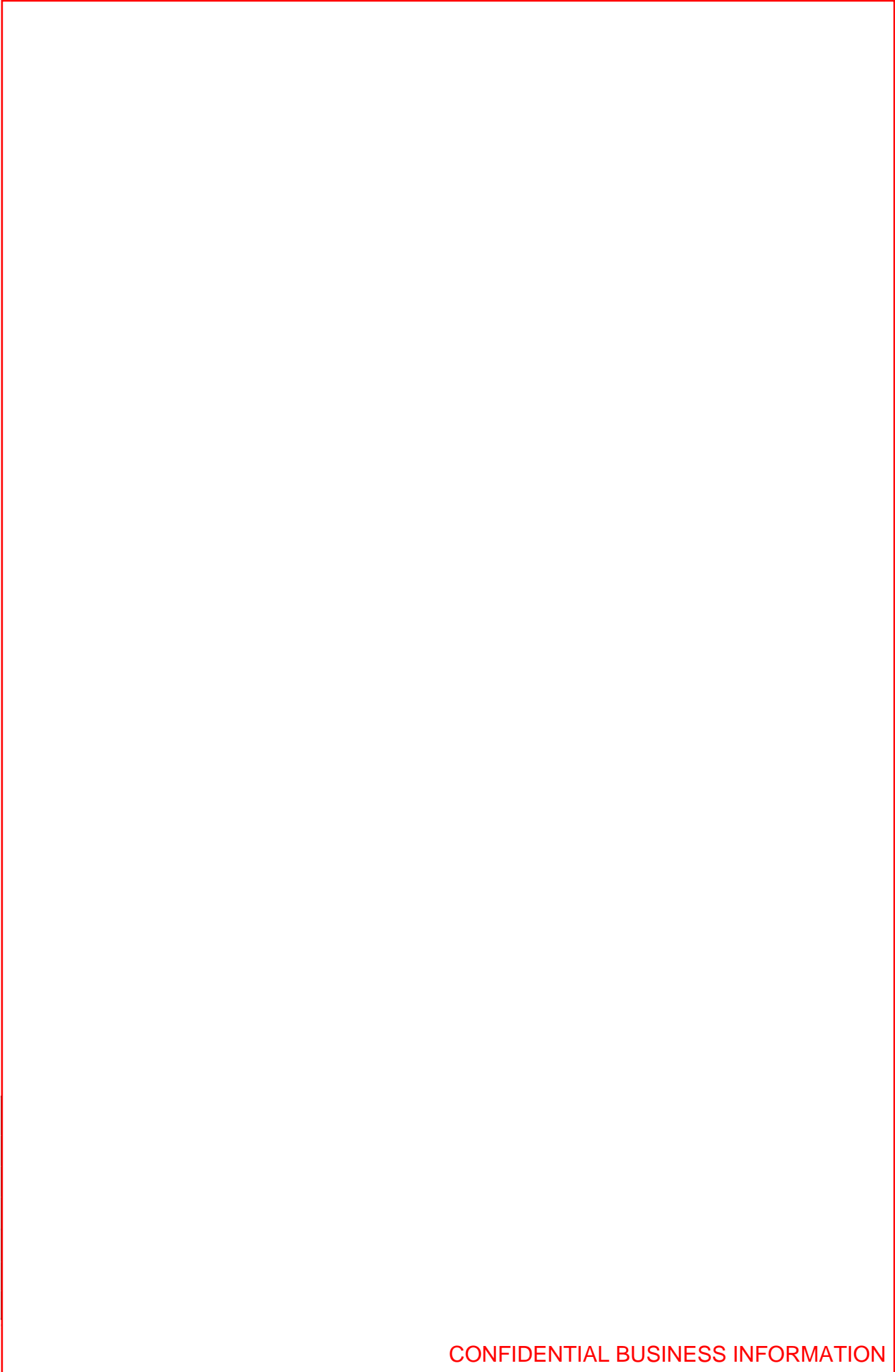

CONFIDENTIAL AND PROPRIETARY
This information carrier and the information it contains are the property of Continental Teves AG & Co. oHG (TEVES). Any reproduction, disclosure or use of either is prohibited without the prior written consent of TEVES. TEVES reserve worldwide all rights also in case of industrial property rights being granted. The same provisions apply to any oral communications related thereto accordingly.



Customer Product Specification
MK25 Safety Concept
TOYOTA 532N ABS/EBD/BTRAC/ETRAC/VSC/HBA

ATE N 655 66.14
Sheet 152
Page 130 of 206

ALLE RECHTE VORBEHALTEN

EIGENTUM DER CONTINENTAL TEVES AG & CO. OHG

VERTRAULICH

Dieser Informationsträger und die darin enthaltenen Informationen sind Eigentum von Continental Teves AG & Co. oHG (TEVES). Jegliche Vervielfältigung, Offenbarung oder Benutzung dieser Informationen ist ohne vorherige schriftliche Zustimmung von TEVES verboten. TEVES behält sich weltweit alle Rechte auch für den Fall der Erteilung von gewerblichen Schutzrechten vor. Die gleichen Regelungen gelten für diesbezügliche mündliche Mitteilungen entsprechend.





Customer Product Specification
MK25 Safety Concept
TOYOTA 532N ABS/EBD/BTRAC/ETRAC/VSC/HBA

ATE N 655 66.14
Sheet 152
Page 131 of 206

ALLE RECHTE VORBEHALTEN

EIGENTUM DER CONTINENTAL TEVES AG & CO. OHG

VERTRAULICH

Dieser Informationsträger und die darin enthaltenen Informationen sind Eigentum von Continental Teves AG & Co. oHG (TEVES). Jegliche Vervielfältigung, Offenbarung oder Benutzung dieser Informationen ist ohne vorherige schriftliche Zustimmung von TEVES verboten. TEVES behält sich weltweit alle Rechte auch für den Fall der Erteilung von gewerblichen Schutzrechten vor. Die gleichen Regelungen gelten für diesbezügliche mündliche Mitteilungen entsprechend.





Customer Product Specification
MK25 Safety Concept
TOYOTA 532N ABS/EBD/BTRAC/ETRAC/VSC/HBA

ATE N 655 66.14
Sheet 152
Page 132 of 206

ALLE RECHTE VORBEHALTEN

EIGENTUM DER CONTINENTAL TEVES AG & CO. OHG

VERTRAULICH

Dieser Informationsträger und die darin enthaltenen Informationen sind Eigentum von Continental Teves AG & Co. oHG (TEVES). Jegliche Vervielfältigung, Offenbarung oder Benutzung dieser Informationen ist ohne vorherige schriftliche Zustimmung von TEVES verboten. TEVES behält sich weltweit alle Rechte auch für den Fall der Erteilung von gewerblichen Schutzrechten vor. Die gleichen Regelungen gelten für diesbezügliche mündliche Mitteilungen entsprechend.

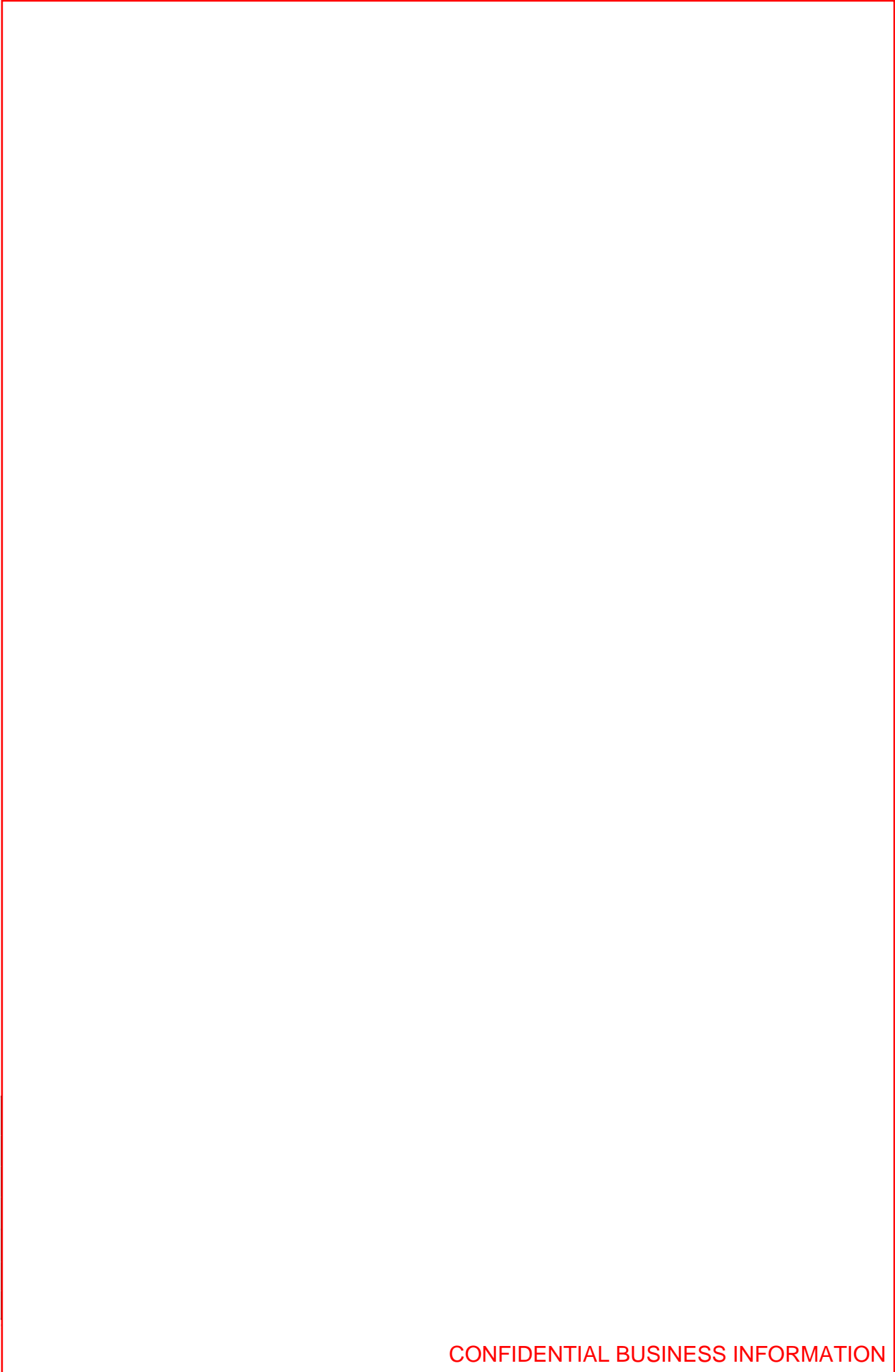

CONFIDENTIAL AND PROPRIETARY
This information carrier and the information it contains are the property of Continental Teves AG & Co. oHG (TEVES). Any reproduction, disclosure or use of either is prohibited without the prior written consent of TEVES. TEVES reserve worldwide all rights also in case of industrial property rights being granted. The same provisions apply to any oral communications related thereto accordingly.



Customer Product Specification
MK25 Safety Concept
TOYOTA 532N ABS/EBD/BTRAC/ETRAC/VSC/HBA

ATE N 655 66.14
Sheet 152
Page 133 of 206

ALLE RECHTE VORBEHALTEN

EIGENTUM DER CONTINENTAL TEVES AG & CO. OHG

VERTRAULICH

Dieser Informationsträger und die darin enthaltenen Informationen sind Eigentum von Continental Teves AG & Co. oHG (TEVES). Jegliche Vervielfältigung, Offenbarung oder Benutzung dieser Informationen ist ohne vorherige schriftliche Zustimmung von TEVES verboten. TEVES behält sich weltweit alle Rechte auch für den Fall der Erteilung von gewerblichen Schutzrechten vor. Die gleichen Regelungen gelten für diesbezügliche mündliche Mitteilungen entsprechend.

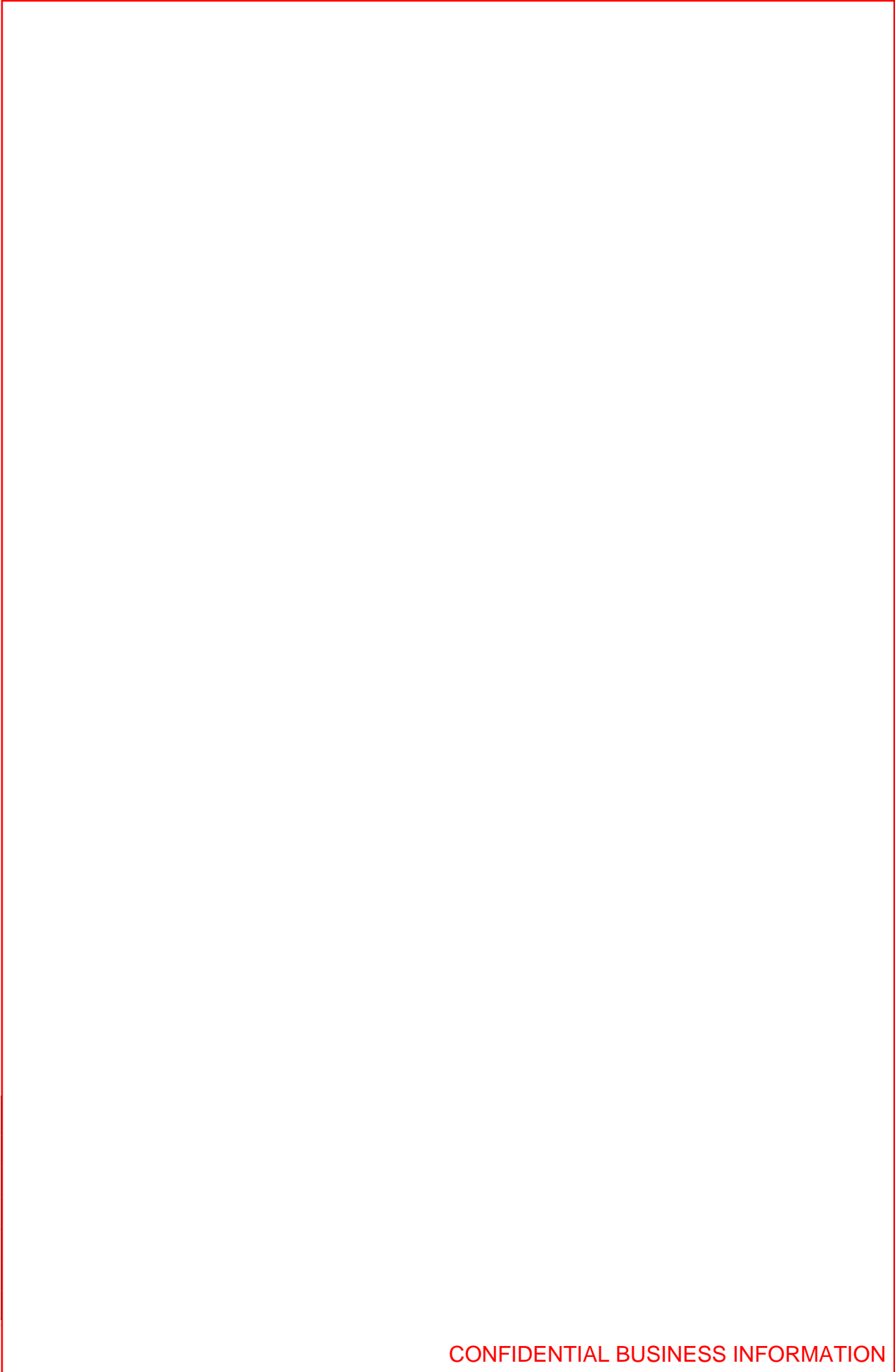



Customer Product Specification
MK25 Safety Concept
TOYOTA 532N ABS/EBD/BTRAC/ETRAC/VSC/HBA

ATE N 655 66.14
Sheet 152
Page 134 of 206

ALLE RECHTE VORBEHALTEN

EIGENTUM DER CONTINENTAL TEVES AG & CO. OHG

VERTRAULICH

Dieser Informationsträger und die darin enthaltenen Informationen sind Eigentum von Continental Teves AG & Co. oHG (TEVES). Jegliche Vervielfältigung, Offenbarung oder Benutzung dieser Informationen ist ohne vorherige schriftliche Zustimmung von TEVES verboten. TEVES behält sich weltweit alle Rechte auch für den Fall der Erteilung von gewerblichen Schutzrechten vor. Die gleichen Regelungen gelten für diesbezügliche mündliche Mitteilungen entsprechend.

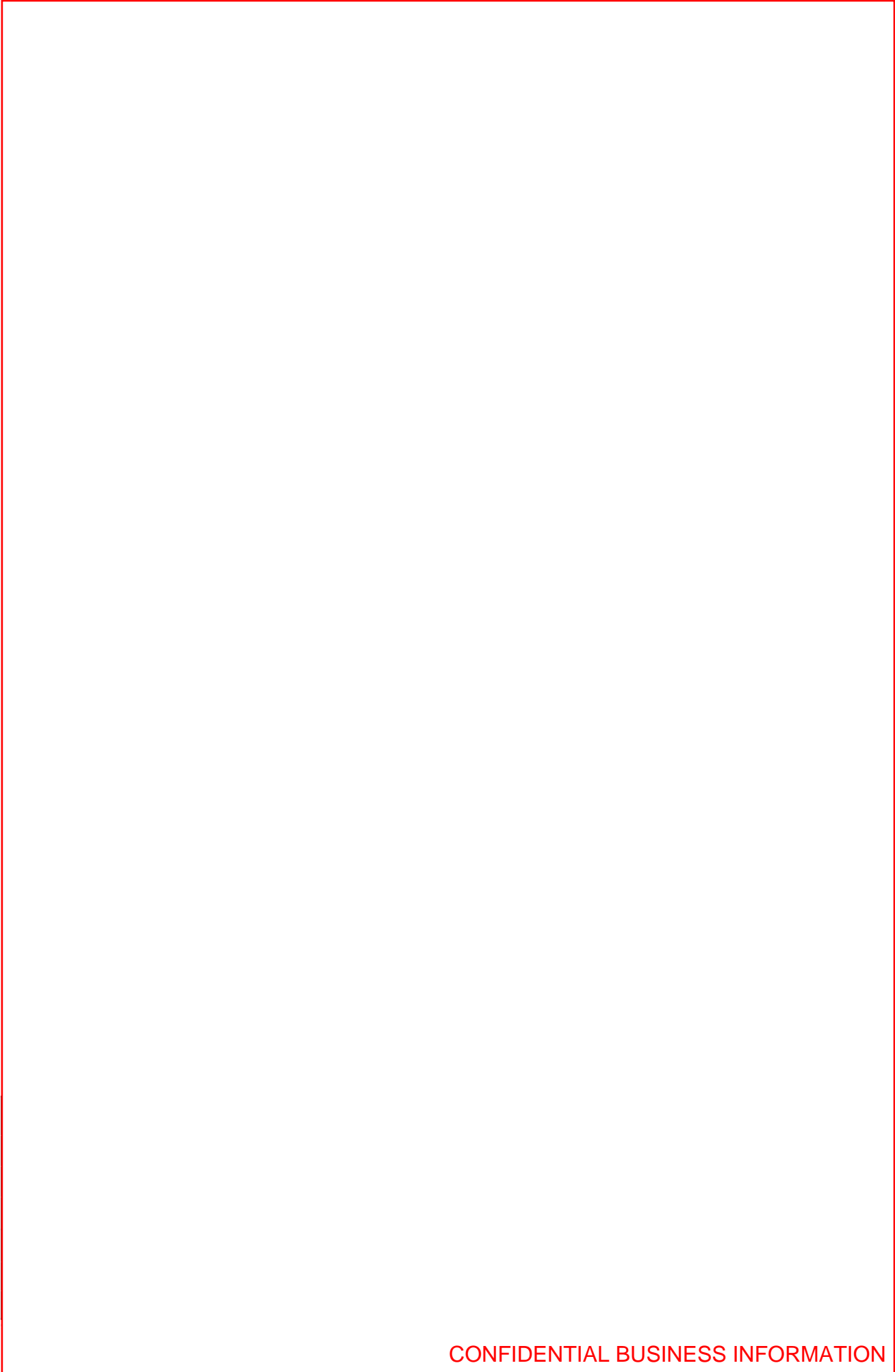



Customer Product Specification
MK25 Safety Concept
TOYOTA 532N ABS/EBD/BTRAC/ETRAC/VSC/HBA

ATE N 655 66.14
Sheet 152
Page 135 of 206

ALLE RECHTE VORBEHALTEN

EIGENTUM DER CONTINENTAL TEVES AG & CO. OHG

VERTRAULICH

Dieser Informationsträger und die darin enthaltenen Informationen sind Eigentum von Continental Teves AG & Co. oHG (TEVES). Jegliche Vervielfältigung, Offenbarung oder Benutzung dieser Informationen ist ohne vorherige schriftliche Zustimmung von TEVES verboten. TEVES behält sich weltweit alle Rechte auch für den Fall der Erteilung von gewerblichen Schutzrechten vor. Die gleichen Regelungen gelten für diesbezügliche mündliche Mitteilungen entsprechend.

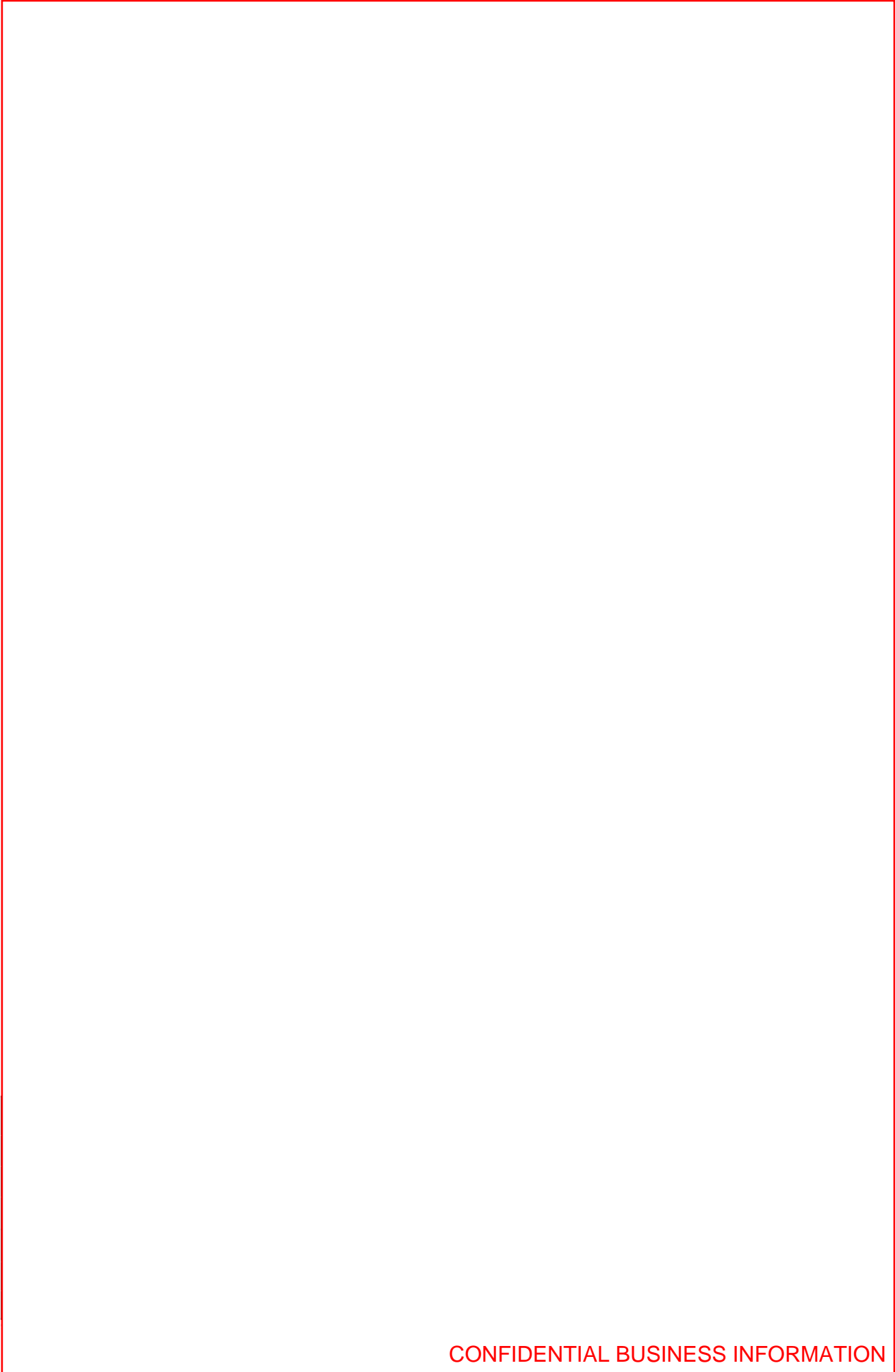

CONFIDENTIAL AND PROPRIETARY
This information carrier and the information it contains are the property of Continental Teves AG & Co. oHG (TEVES). Any reproduction, disclosure or use of either is prohibited without the prior written consent of TEVES. TEVES reserve worldwide all rights also in case of industrial property rights being granted. The same provisions apply to any oral communications related thereto accordingly.

PROPERTY OF CONTINENTAL TEVES AG & CO. OHG
ALL RIGHTS RESERVED



Customer Product Specification
MK25 Safety Concept
TOYOTA 532N ABS/EBD/BTRAC/ETRAC/VSC/HBA

ATE N 655 66.14
Sheet 152
Page 136 of 206

ALLE RECHTE VORBEHALTEN

EIGENTUM DER CONTINENTAL TEVES AG & CO. OHG

VERTRAULICH

Dieser Informationsträger und die darin enthaltenen Informationen sind Eigentum von Continental Teves AG & Co. oHG (TEVES). Jegliche Vervielfältigung, Offenbarung oder Benutzung dieser Informationen ist ohne vorherige schriftliche Zustimmung von TEVES verboten. TEVES behält sich weltweit alle Rechte auch für den Fall der Erteilung von gewerblichen Schutzrechten vor. Die gleichen Regelungen gelten für diesbezügliche mündliche Mitteilungen entsprechend.



CONFIDENTIAL AND PROPRIETARY
This information carrier and the information it contains are the property of Continental Teves AG & Co. oHG (TEVES). Any reproduction, disclosure or use of either is prohibited without the prior written consent of TEVES. TEVES reserve worldwide all rights also in case of industrial property rights being granted. The same provisions apply to any oral communications related thereto accordingly.

PROPERTY OF CONTINENTAL TEVES AG & CO. OHG
ALL RIGHTS RESERVED



Customer Product Specification
MK25 Safety Concept
TOYOTA 532N ABS/EBD/BTRAC/ETRAC/VSC/HBA

ATE N 655 66.14
Sheet 152
Page 137 of 206

ALLE RECHTE VORBEHALTEN

EIGENTUM DER CONTINENTAL TEVES AG & CO. OHG

VERTRAULICH

Dieser Informationsträger und die darin enthaltenen Informationen sind Eigentum von Continental Teves AG & Co. oHG (TEVES). Jegliche Vervielfältigung, Offenbarung oder Benutzung dieser Informationen ist ohne vorherige schriftliche Zustimmung von TEVES verboten. TEVES behält sich weltweit alle Rechte auch für den Fall der Erteilung von gewerblichen Schutzrechten vor. Die gleichen Regelungen gelten für diesbezügliche mündliche Mitteilungen entsprechend.



CONFIDENTIAL AND PROPRIETARY
This information carrier and the information it contains are the property of Continental Teves AG & Co. oHG (TEVES). Any reproduction, disclosure or use of either is prohibited without the prior written consent of TEVES. TEVES reserve worldwide all rights also in case of industrial property rights being granted. The same provisions apply to any oral communications related thereto accordingly.



Customer Product Specification
MK25 Safety Concept
TOYOTA 532N ABS/EBD/BTRAC/ETRAC/VSC/HBA

ATE N 655 66.14
Sheet 152
Page 138 of 206

ALLE RECHTE VORBEHALTEN

EIGENTUM DER CONTINENTAL TEVES AG & CO. OHG

VERTRAULICH

Dieser Informationsträger und die darin enthaltenen Informationen sind Eigentum von Continental Teves AG & Co. oHG (TEVES). Jegliche Vervielfältigung, Offenbarung oder Benutzung dieser Informationen ist ohne vorherige schriftliche Zustimmung von TEVES verboten. TEVES behält sich weltweit alle Rechte auch für den Fall der Erteilung von gewerblichen Schutzrechten vor. Die gleichen Regelungen gelten für diesbezügliche mündliche Mitteilungen entsprechend.



CONFIDENTIAL AND PROPRIETARY
This information carrier and the information it contains are the property of Continental Teves AG & Co. oHG (TEVES). Any reproduction, disclosure or use of either is prohibited without the prior written consent of TEVES. TEVES reserve worldwide all rights also in case of industrial property rights being granted. The same provisions apply to any oral communications related thereto accordingly.



Customer Product Specification
MK25 Safety Concept
TOYOTA 532N ABS/EBD/BTRAC/ETRAC/VSC/HBA

ATE N 655 66.14
Sheet 152
Page 139 of 206

ALLE RECHTE VORBEHALTEN

EIGENTUM DER CONTINENTAL TEVES AG & CO. OHG

VERTRAULICH

Dieser Informationsträger und die darin enthaltenen Informationen sind Eigentum von Continental Teves AG & Co. oHG (TEVES). Jegliche Vervielfältigung, Offenbarung oder Benutzung dieser Informationen ist ohne vorherige schriftliche Zustimmung von TEVES verboten. TEVES behält sich weltweit alle Rechte auch für den Fall der Erteilung von gewerblichen Schutzrechten vor. Die gleichen Regelungen gelten für diesbezügliche mündliche Mitteilungen entsprechend.

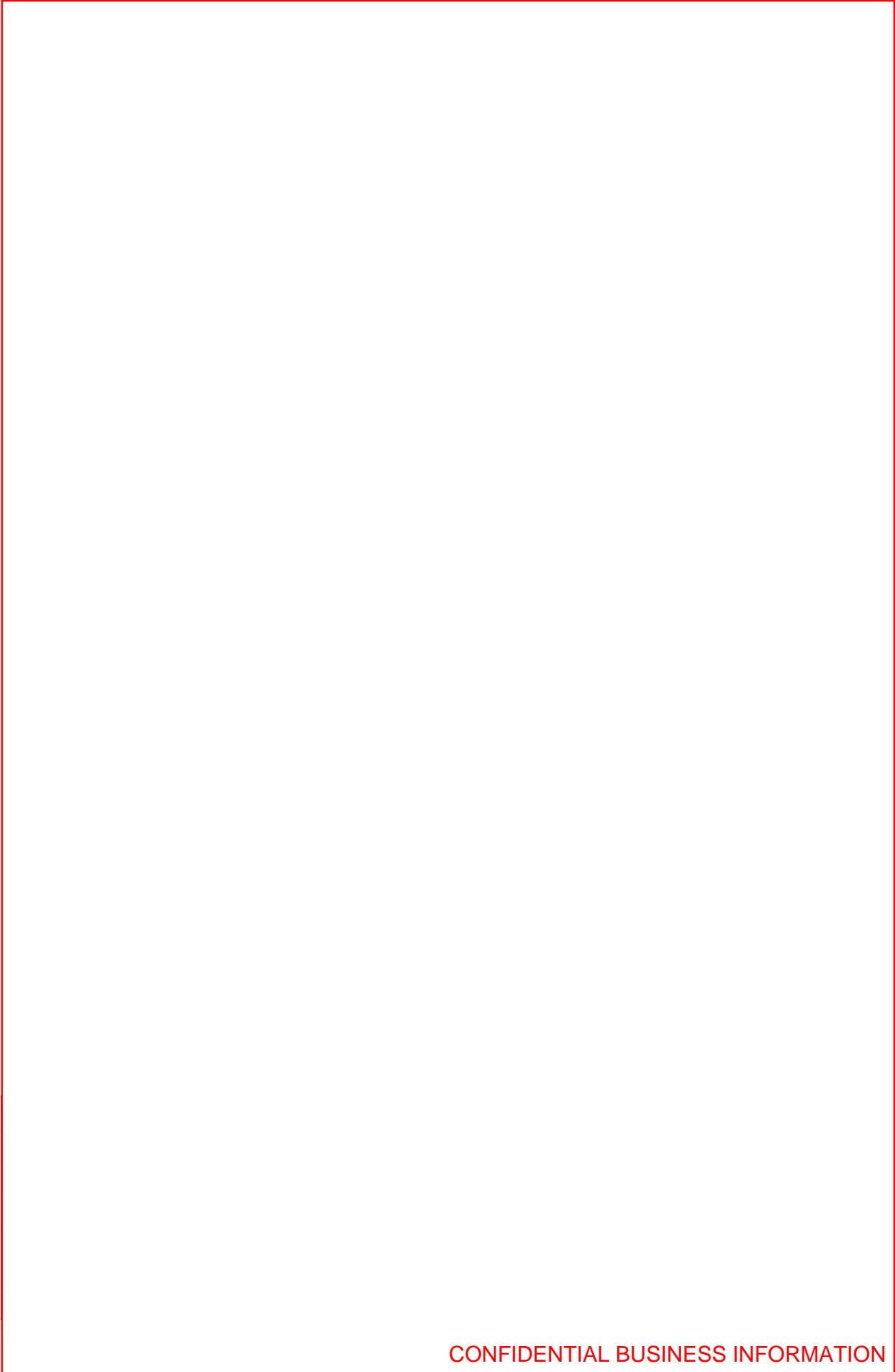

CONFIDENTIAL AND PROPRIETARY
This information carrier and the information it contains are the property of Continental Teves AG & Co. oHG (TEVES). Any reproduction, disclosure or use of either is prohibited without the prior written consent of TEVES. TEVES reserve worldwide all rights also in case of industrial property rights being granted. The same provisions apply to any oral communications related thereto accordingly.

PROPERTY OF CONTINENTAL TEVES AG & CO. OHG
ALL RIGHTS RESERVED



Customer Product Specification
MK25 Safety Concept
TOYOTA 532N ABS/EBD/BTRAC/ETRAC/VSC/HBA

ATE N 655 66.14
Sheet 152
Page 140 of 206

ALLE RECHTE VORBEHALTEN

EIGENTUM DER CONTINENTAL TEVES AG & CO. OHG

VERTRAULICH

Dieser Informationsträger und die darin enthaltenen Informationen sind Eigentum von Continental Teves AG & Co. oHG (TEVES). Jegliche Vervielfältigung, Offenbarung oder Benutzung dieser Informationen ist ohne vorherige schriftliche Zustimmung von TEVES verboten. TEVES behält sich weltweit alle Rechte auch für den Fall der Erteilung von gewerblichen Schutzrechten vor. Die gleichen Regelungen gelten für diesbezügliche mündliche Mitteilungen entsprechend.

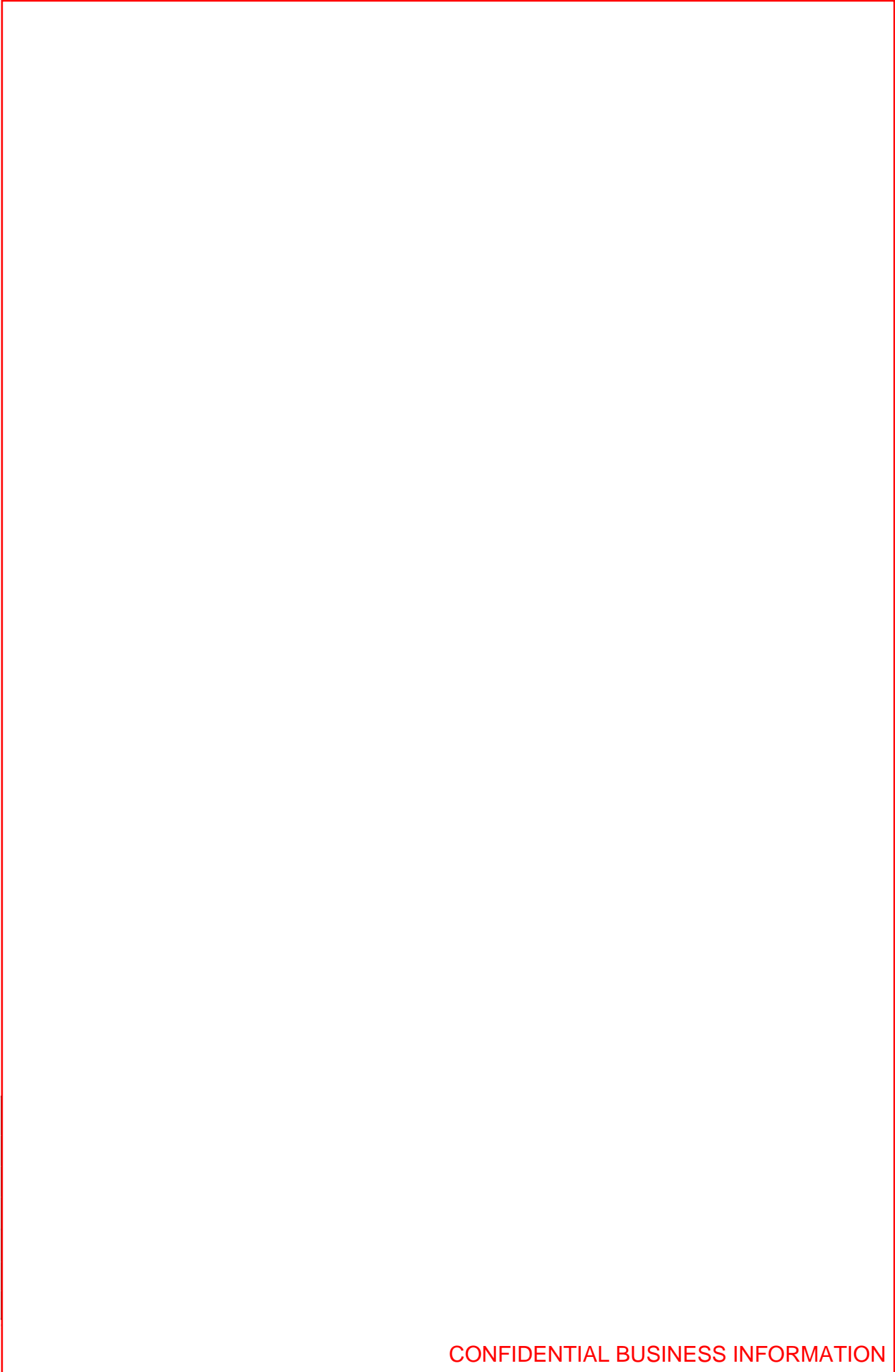

CONFIDENTIAL AND PROPRIETARY
This information carrier and the information it contains are the property of Continental Teves AG & Co. oHG (TEVES). Any reproduction, disclosure or use of either is prohibited without the prior written consent of TEVES. TEVES reserve worldwide all rights also in case of industrial property rights being granted. The same provisions apply to any oral communications related thereto accordingly.

PROPERTY OF CONTINENTAL TEVES AG & CO. OHG
ALL RIGHTS RESERVED



Customer Product Specification
MK25 Safety Concept
TOYOTA 532N ABS/EBD/BTRAC/ETRAC/VSC/HBA

ATE N 655 66.14
Sheet 152
Page 141 of 206

ALLE RECHTE VORBEHALTEN

EIGENTUM DER CONTINENTAL TEVES AG & CO. OHG

VERTRAULICH

Dieser Informationsträger und die darin enthaltenen Informationen sind Eigentum von Continental Teves AG & Co. oHG (TEVES). Jegliche Vervielfältigung, Offenbarung oder Benutzung dieser Informationen ist ohne vorherige schriftliche Zustimmung von TEVES verboten. TEVES behält sich weltweit alle Rechte auch für den Fall der Erteilung von gewerblichen Schutzrechten vor. Die gleichen Regelungen gelten für diesbezügliche mündliche Mitteilungen entsprechend.

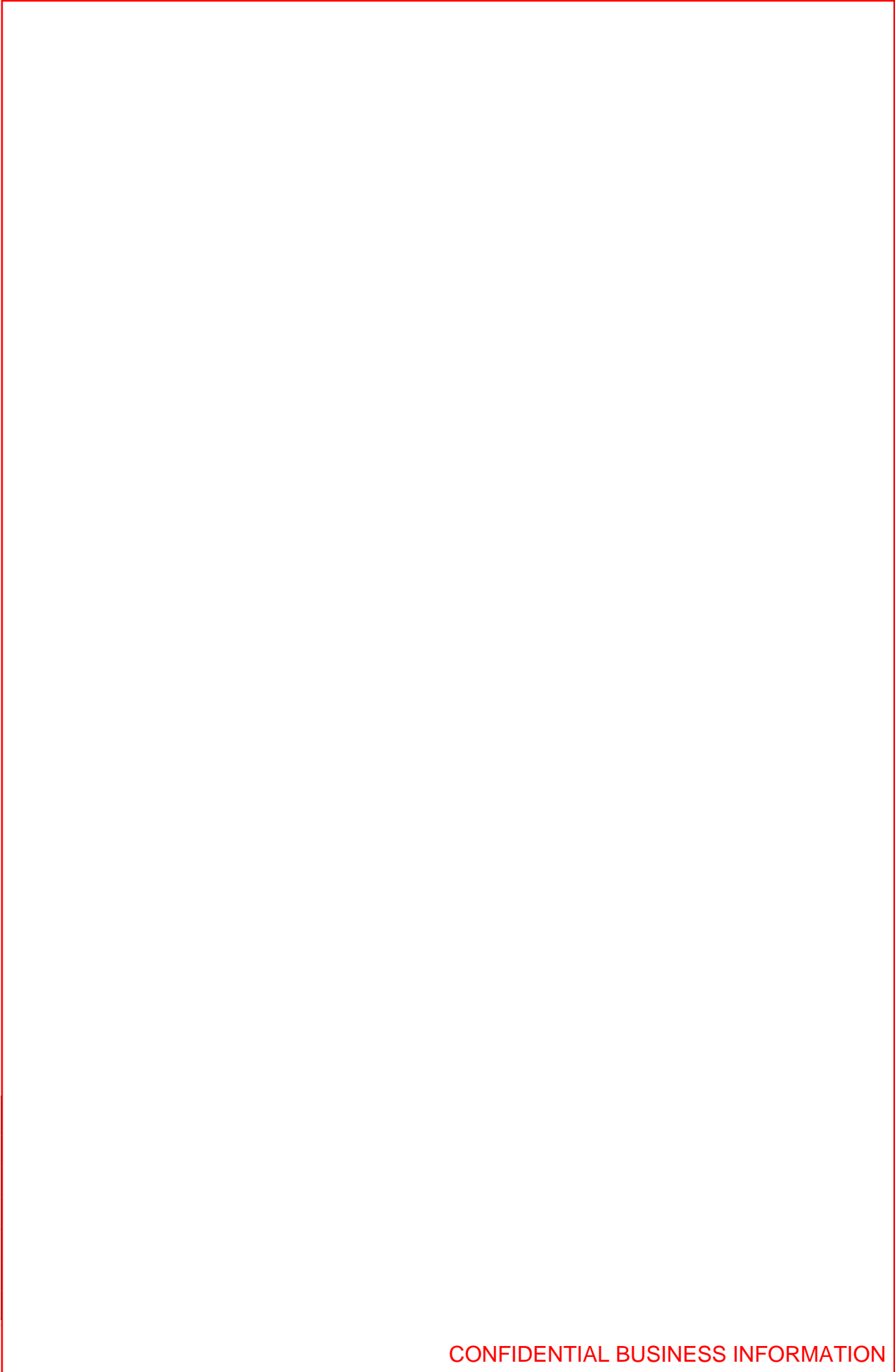



Customer Product Specification
MK25 Safety Concept
TOYOTA 532N ABS/EBD/BTRAC/ETRAC/VSC/HBA

ATE N 655 66.14
Sheet 152
Page 142 of 206

ALLE RECHTE VORBEHALTEN

EIGENTUM DER CONTINENTAL TEVES AG & CO. OHG

VERTRAULICH

Dieser Informationsträger und die darin enthaltenen Informationen sind Eigentum von Continental Teves AG & Co. oHG (TEVES). Jegliche Vervielfältigung, Offenbarung oder Benutzung dieser Informationen ist ohne vorherige schriftliche Zustimmung von TEVES verboten. TEVES behält sich weltweit alle Rechte auch für den Fall der Erteilung von gewerblichen Schutzrechten vor. Die gleichen Regelungen gelten für diesbezügliche mündliche Mitteilungen entsprechend.

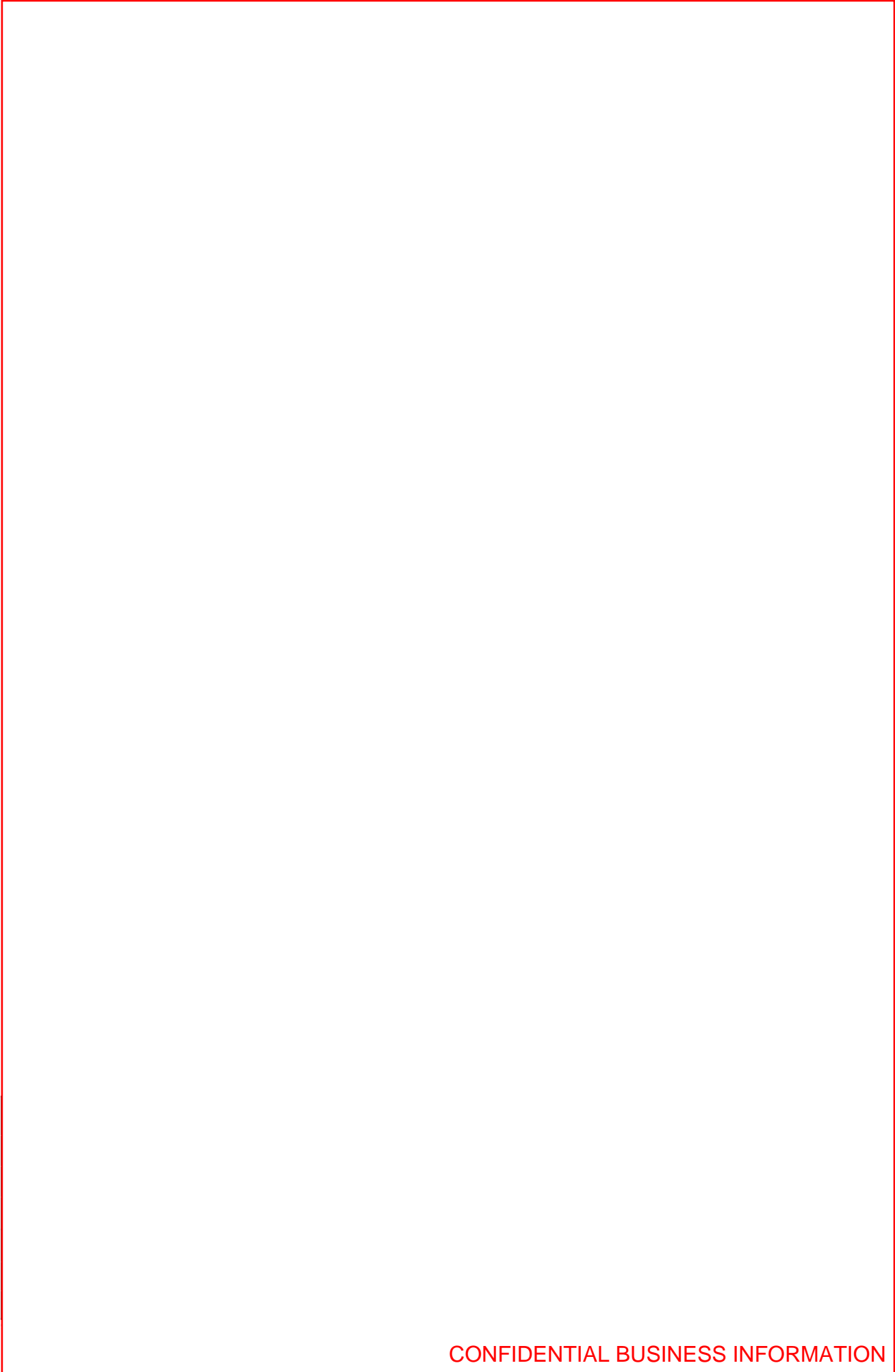



Customer Product Specification
MK25 Safety Concept
TOYOTA 532N ABS/EBD/BTRAC/ETRAC/VSC/HBA

ATE N 655 66.14
Sheet 152
Page 143 of 206

ALLE RECHTE VORBEHALTEN

EIGENTUM DER CONTINENTAL TEVES AG & CO. OHG

VERTRAULICH

Dieser Informationsträger und die darin enthaltenen Informationen sind Eigentum von Continental Teves AG & Co. oHG (TEVES). Jegliche Vervielfältigung, Offenbarung oder Benutzung dieser Informationen ist ohne vorherige schriftliche Zustimmung von TEVES verboten. TEVES behält sich weltweit alle Rechte auch für den Fall der Erteilung von gewerblichen Schutzrechten vor. Die gleichen Regelungen gelten für diesbezügliche mündliche Mitteilungen entsprechend.

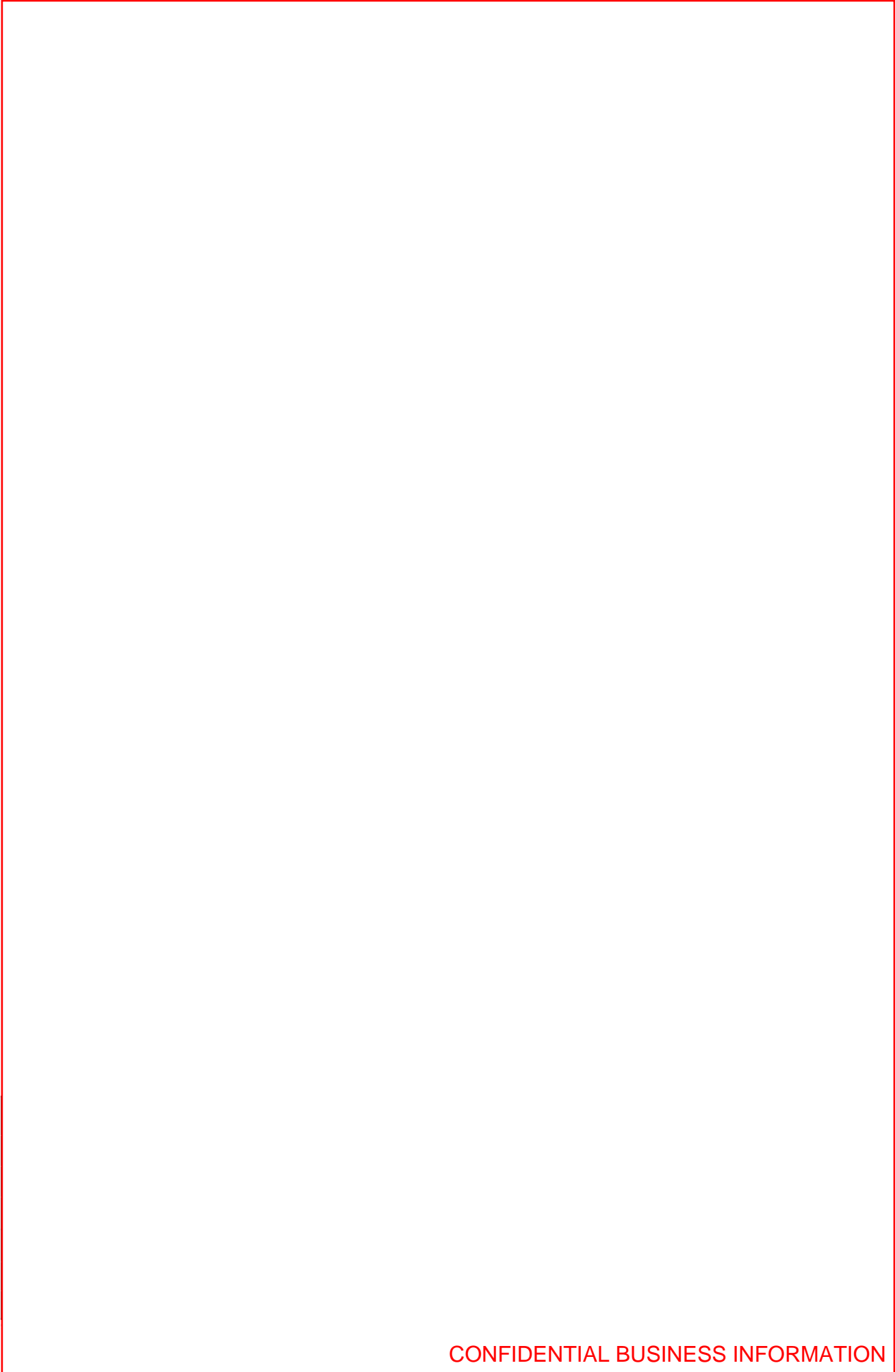

CONFIDENTIAL AND PROPRIETARY
This information carrier and the information it contains are the property of Continental Teves AG & Co. oHG (TEVES). Any reproduction, disclosure or use of either is prohibited without the prior written consent of TEVES. TEVES reserve worldwide all rights also in case of industrial property rights being granted. The same provisions apply to any oral communications related thereto accordingly.



Customer Product Specification
MK25 Safety Concept
TOYOTA 532N ABS/EBD/BTRAC/ETRAC/VSC/HBA

ATE N 655 66.14
Sheet 152
Page 144 of 206

ALLE RECHTE VORBEHALTEN

EIGENTUM DER CONTINENTAL TEVES AG & CO. OHG

VERTRAULICH

Dieser Informationsträger und die darin enthaltenen Informationen sind Eigentum von Continental Teves AG & Co. oHG (TEVES). Jegliche Vervielfältigung, Offenbarung oder Benutzung dieser Informationen ist ohne vorherige schriftliche Zustimmung von TEVES verboten. TEVES behält sich weltweit alle Rechte auch für den Fall der Erteilung von gewerblichen Schutzrechten vor. Die gleichen Regelungen gelten für diesbezügliche mündliche Mitteilungen entsprechend.



CONFIDENTIAL AND PROPRIETARY
This information carrier and the information it contains are the property of Continental Teves AG & Co. oHG (TEVES). Any reproduction, disclosure or use of either is prohibited without the prior written consent of TEVES. TEVES reserve worldwide all rights also in case of industrial property rights being granted. The same provisions apply to any oral communications related thereto accordingly.



Customer Product Specification
MK25 Safety Concept
TOYOTA 532N ABS/EBD/BTRAC/ETRAC/VSC/HBA

ATE N 655 66.14
Sheet 152
Page 145 of 206

ALLE RECHTE VORBEHALTEN

EIGENTUM DER CONTINENTAL TEVES AG & CO. OHG

VERTRAULICH

Dieser Informationsträger und die darin enthaltenen Informationen sind Eigentum von Continental Teves AG & Co. oHG (TEVES). Jegliche Vervielfältigung, Offenbarung oder Benutzung dieser Informationen ist ohne vorherige schriftliche Zustimmung von TEVES verboten. TEVES behält sich weltweit alle Rechte auch für den Fall der Erteilung von gewerblichen Schutzrechten vor. Die gleichen Regelungen gelten für diesbezügliche mündliche Mitteilungen entsprechend.



CONFIDENTIAL AND PROPRIETARY
This information carrier and the information it contains are the property of Continental Teves AG & Co. oHG (TEVES). Any reproduction, disclosure or use of either is prohibited without the prior written consent of TEVES. TEVES reserve worldwide all rights also in case of industrial property rights being granted. The same provisions apply to any oral communications related thereto accordingly.

PROPERTY OF CONTINENTAL TEVES AG & CO. OHG

ALL RIGHTS RESERVED



Customer Product Specification
MK25 Safety Concept
TOYOTA 532N ABS/EBD/BTRAC/ETRAC/VSC/HBA

ATE N 655 66.14
Sheet 152
Page 146 of 206

ALLE RECHTE VORBEHALTEN

EIGENTUM DER CONTINENTAL TEVES AG & CO. OHG

VERTRAULICH

Dieser Informationsträger und die darin enthaltenen Informationen sind Eigentum von Continental Teves AG & Co. oHG (TEVES). Jegliche Vervielfältigung, Offenbarung oder Benutzung dieser Informationen ist ohne vorherige schriftliche Zustimmung von TEVES verboten. TEVES behält sich weltweit alle Rechte auch für den Fall der Erteilung von gewerblichen Schutzrechten vor. Die gleichen Regelungen gelten für diesbezügliche mündliche Mitteilungen entsprechend.



CONFIDENTIAL AND PROPRIETARY
This information carrier and the information it contains are the property of Continental Teves AG & Co. oHG (TEVES). Any reproduction, disclosure or use of either is prohibited without the prior written consent of TEVES. TEVES reserve worldwide all rights also in case of industrial property rights being granted. The same provisions apply to any oral communications related thereto accordingly.

PROPERTY OF CONTINENTAL TEVES AG & CO. OHG
ALL RIGHTS RESERVED



Customer Product Specification
MK25 Safety Concept
TOYOTA 532N ABS/EBD/BTRAC/ETRAC/VSC/HBA

ATE N 655 66.14
Sheet 152
Page 147 of 206

ALLE RECHTE VORBEHALTEN

EIGENTUM DER CONTINENTAL TEVES AG & CO. OHG

VERTRAULICH

Dieser Informationsträger und die darin enthaltenen Informationen sind Eigentum von Continental Teves AG & Co. oHG (TEVES). Jegliche Vervielfältigung, Offenbarung oder Benutzung dieser Informationen ist ohne vorherige schriftliche Zustimmung von TEVES verboten. TEVES behält sich weltweit alle Rechte auch für den Fall der Erteilung von gewerblichen Schutzrechten vor. Die gleichen Regelungen gelten für diesbezügliche mündliche Mitteilungen entsprechend.



	<p>Customer Product Specification MK25 Safety Concept TOYOTA 532N ABS/EBD/BTRAC/ETRAC/VSC/HBA</p>	<p>ATE N 655 66.14 Sheet 152 Page 148 of 206</p>
--	---	--

ALLE RECHTE VORBEHALTEN

EIGENTUM DER CONTINENTAL TEVES AG & CO. OHG

VERTRAULICH

Dieser Informationsträger und die darin enthaltenen Informationen sind Eigentum von Continental Teves AG & Co. oHG (TEVES). Jegliche Vervielfältigung, Offenbarung oder Benutzung dieser Informationen ist ohne vorherige schriftliche Zustimmung von TEVES verboten. TEVES behält sich weltweit alle Rechte auch für den Fall der Erteilung von gewerblichen Schutzrechten vor. Die gleichen Regelungen gelten für diesbezügliche mündliche Mitteilungen entsprechend.

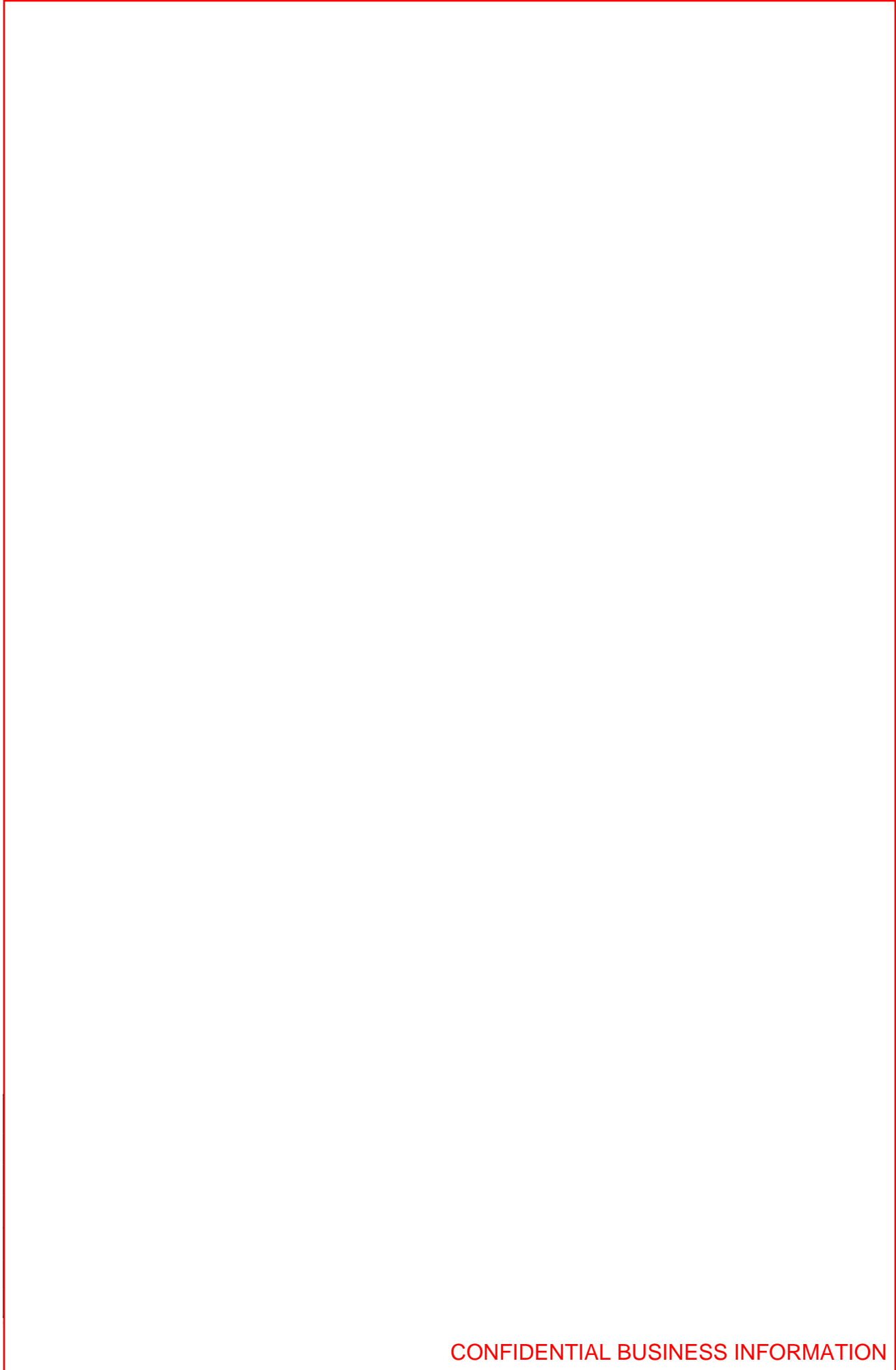



Customer Product Specification
MK25 Safety Concept
TOYOTA 532N ABS/EBD/BTRAC/ETRAC/VSC/HBA

ATE N 655 66.14
Sheet 152
Page 149 of 206

ALLE RECHTE VORBEHALTEN

EIGENTUM DER CONTINENTAL TEVES AG & CO. OHG

VERTRAULICH

Dieser Informationsträger und die darin enthaltenen Informationen sind Eigentum von Continental Teves AG & Co. oHG (TEVES). Jegliche Vervielfältigung, Offenbarung oder Benutzung dieser Informationen ist ohne vorherige schriftliche Zustimmung von TEVES verboten. TEVES behält sich weltweit alle Rechte auch für den Fall der Erteilung von gewerblichen Schutzrechten vor. Die gleichen Regelungen gelten für diesbezügliche mündliche Mitteilungen entsprechend.





Customer Product Specification
MK25 Safety Concept
TOYOTA 532N ABS/EBD/BTRAC/ETRAC/VSC/HBA

ATE N 655 66.14
Sheet 152
Page 150 of 206

ALLE RECHTE VORBEHALTEN

EIGENTUM DER CONTINENTAL TEVES AG & CO. OHG

VERTRAULICH

Dieser Informationsträger und die darin enthaltenen Informationen sind Eigentum von Continental Teves AG & Co. oHG (TEVES). Jegliche Vervielfältigung, Offenbarung oder Benutzung dieser Informationen ist ohne vorherige schriftliche Zustimmung von TEVES verboten. TEVES behält sich weltweit alle Rechte auch für den Fall der Erteilung von gewerblichen Schutzrechten vor. Die gleichen Regelungen gelten für diesbezügliche mündliche Mitteilungen entsprechend.



CONFIDENTIAL AND PROPRIETARY
This information carrier and the information it contains are the property of Continental Teves AG & Co. oHG (TEVES). Any reproduction, disclosure or use of either is prohibited without the prior written consent of TEVES. TEVES reserve worldwide all rights also in case of industrial property rights being granted. The same provisions apply to any oral communications related thereto accordingly.

PROPERTY OF CONTINENTAL TEVES AG & CO. OHG
ALL RIGHTS RESERVED



Customer Product Specification
MK25 Safety Concept
TOYOTA 532N ABS/EBD/BTRAC/ETRAC/VSC/HBA

ATE N 655 66.14
Sheet 152
Page 151 of 206

ALLE RECHTE VORBEHALTEN

EIGENTUM DER CONTINENTAL TEVES AG & CO. OHG

VERTRAULICH

Dieser Informationsträger und die darin enthaltenen Informationen sind Eigentum von Continental Teves AG & Co. oHG (TEVES). Jegliche Vervielfältigung, Offenbarung oder Benutzung dieser Informationen ist ohne vorherige schriftliche Zustimmung von TEVES verboten. TEVES behält sich weltweit alle Rechte auch für den Fall der Erteilung von gewerblichen Schutzrechten vor. Die gleichen Regelungen gelten für diesbezügliche mündliche Mitteilungen entsprechend.



CONFIDENTIAL AND PROPRIETARY
This information carrier and the information it contains are the property of Continental Teves AG & Co. oHG (TEVES). Any reproduction, disclosure or use of either is prohibited without the prior written consent of TEVES. TEVES reserve worldwide all rights also in case of industrial property rights being granted. The same provisions apply to any oral communications related thereto accordingly.



Customer Product Specification
MK25 Safety Concept
TOYOTA 532N ABS/EBD/BTRAC/ETRAC/VSC/HBA

ATE N 655 66.14
Sheet 152
Page 152 of 206

ALLE RECHTE VORBEHALTEN

EIGENTUM DER CONTINENTAL TEVES AG & CO. OHG

VERTRAULICH

Dieser Informationsträger und die darin enthaltenen Informationen sind Eigentum von Continental Teves AG & Co. oHG (TEVES). Jegliche Vervielfältigung, Offenbarung oder Benutzung dieser Informationen ist ohne vorherige schriftliche Zustimmung von TEVES verboten. TEVES behält sich weltweit alle Rechte auch für den Fall der Erteilung von gewerblichen Schutzrechten vor. Die gleichen Regelungen gelten für diesbezügliche mündliche Mitteilungen entsprechend.





Customer Product Specification
MK25 Safety Concept
TOYOTA 532N ABS/EBD/BTRAC/ETRAC/VSC/HBA

ATE N 655 66.14
Sheet 152
Page 153 of 206

ALLE RECHTE VORBEHALTEN

EIGENTUM DER CONTINENTAL TEVES AG & CO. OHG

VERTRAULICH

Dieser Informationsträger und die darin enthaltenen Informationen sind Eigentum von Continental Teves AG & Co. oHG (TEVES). Jegliche Vervielfältigung, Offenbarung oder Benutzung dieser Informationen ist ohne vorherige schriftliche Zustimmung von TEVES verboten. TEVES behält sich weltweit alle Rechte auch für den Fall der Erteilung von gewerblichen Schutzrechten vor. Die gleichen Regelungen gelten für diesbezügliche mündliche Mitteilungen entsprechend.

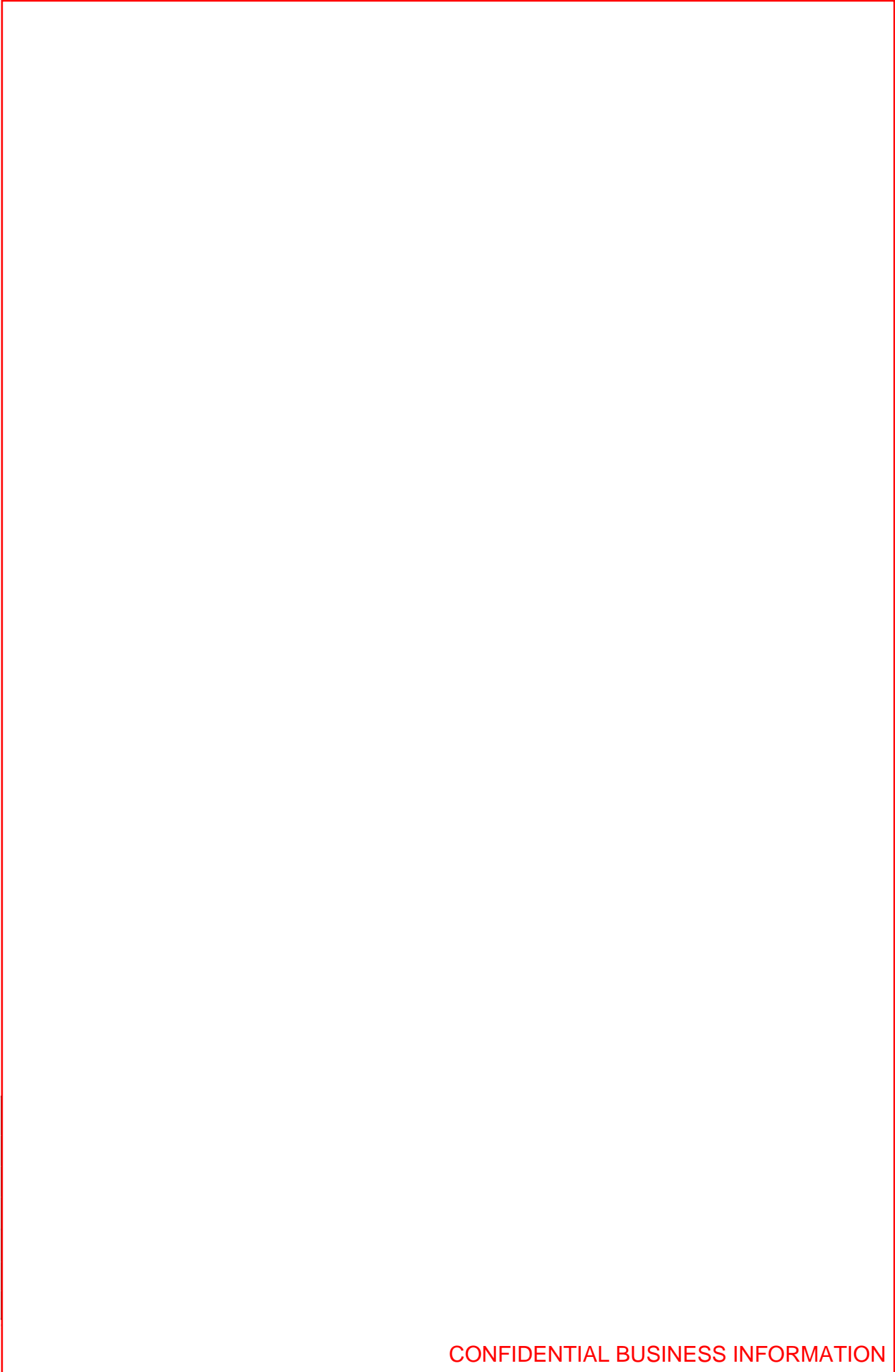

CONFIDENTIAL AND PROPRIETARY
This information carrier and the information it contains are the property of Continental Teves AG & Co. oHG (TEVES). Any reproduction, disclosure or use of either is prohibited without the prior written consent of TEVES. TEVES reserve worldwide all rights also in case of industrial property rights being granted. The same provisions apply to any oral communications related thereto accordingly.



Customer Product Specification
MK25 Safety Concept
TOYOTA 532N ABS/EBD/BTRAC/ETRAC/VSC/HBA

ATE N 655 66.14
Sheet 152
Page 154 of 206

ALLE RECHTE VORBEHALTEN

EIGENTUM DER CONTINENTAL TEVES AG & CO. OHG

VERTRAULICH

Dieser Informationsträger und die darin enthaltenen Informationen sind Eigentum von Continental Teves AG & Co. oHG (TEVES). Jegliche Vervielfältigung, Offenbarung oder Benutzung dieser Informationen ist ohne vorherige schriftliche Zustimmung von TEVES verboten. TEVES behält sich weltweit alle Rechte auch für den Fall der Erteilung von gewerblichen Schutzrechten vor. Die gleichen Regelungen gelten für diesbezügliche mündliche Mitteilungen entsprechend.





Customer Product Specification
MK25 Safety Concept
TOYOTA 532N ABS/EBD/BTRAC/ETRAC/VSC/HBA

ATE N 655 66.14
Sheet 152
Page 155 of 206

ALLE RECHTE VORBEHALTEN

EIGENTUM DER CONTINENTAL TEVES AG & CO. OHG

VERTRAULICH

Dieser Informationsträger und die darin enthaltenen Informationen sind Eigentum von Continental Teves AG & Co. oHG (TEVES). Jegliche Vervielfältigung, Offenbarung oder Benutzung dieser Informationen ist ohne vorherige schriftliche Zustimmung von TEVES verboten. TEVES behält sich weltweit alle Rechte auch für den Fall der Erteilung von gewerblichen Schutzrechten vor. Die gleichen Regelungen gelten für diesbezügliche mündliche Mitteilungen entsprechend.

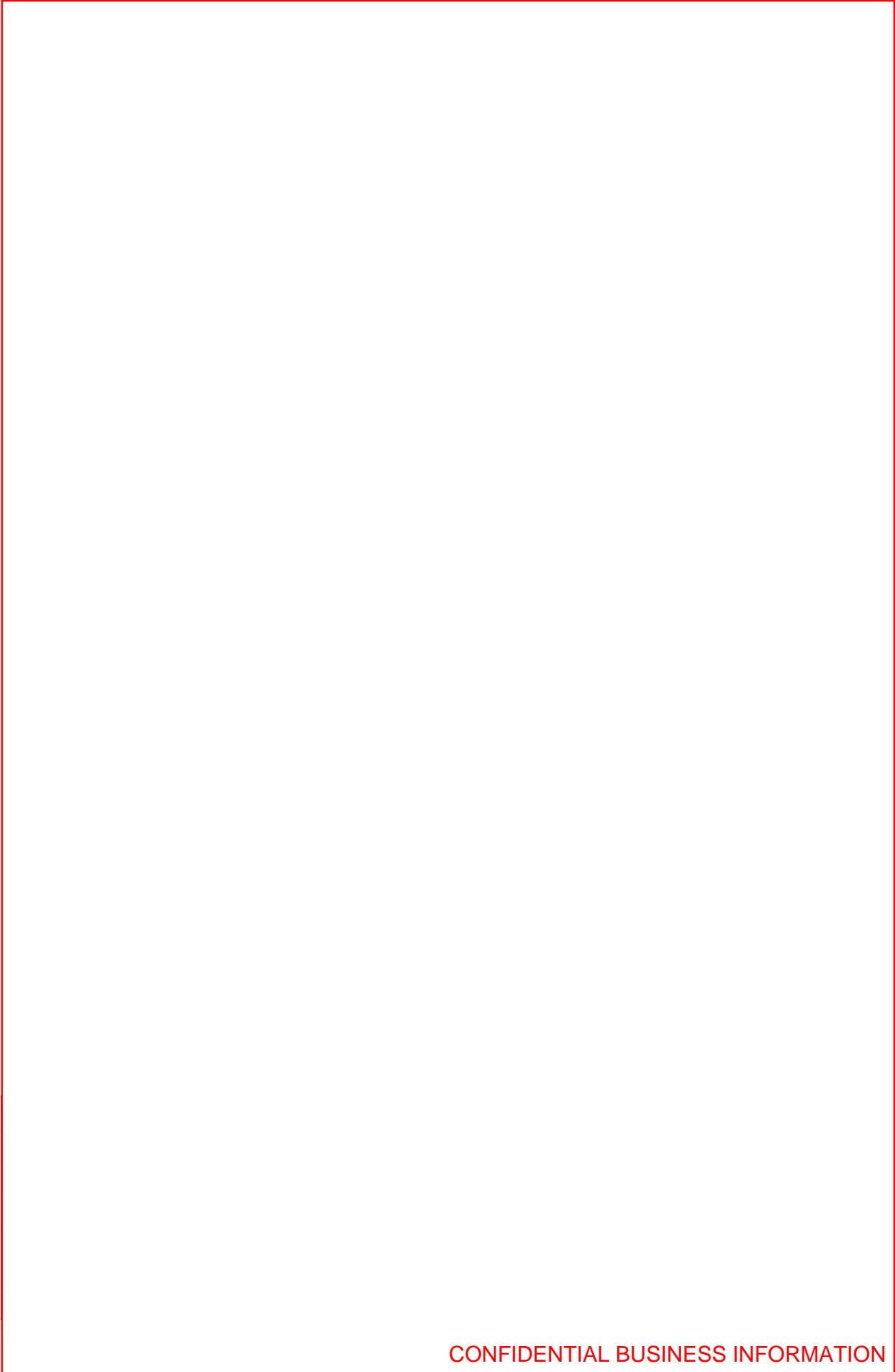

CONFIDENTIAL AND PROPRIETARY
This information carrier and the information it contains are the property of Continental Teves AG & Co. oHG (TEVES). Any reproduction, disclosure or use of either is prohibited without the prior written consent of TEVES. TEVES reserve worldwide all rights also in case of industrial property rights being granted. The same provisions apply to any oral communications related thereto accordingly.



Customer Product Specification
MK25 Safety Concept
TOYOTA 532N ABS/EBD/BTRAC/ETRAC/VSC/HBA

ATE N 655 66.14
Sheet 152
Page 156 of 206

ALLE RECHTE VORBEHALTEN

EIGENTUM DER CONTINENTAL TEVES AG & CO. OHG

VERTRAULICH

Dieser Informationsträger und die darin enthaltenen Informationen sind Eigentum von Continental Teves AG & Co. oHG (TEVES). Jegliche Vervielfältigung, Offenbarung oder Benutzung dieser Informationen ist ohne vorherige schriftliche Zustimmung von TEVES verboten. TEVES behält sich weltweit alle Rechte auch für den Fall der Erteilung von gewerblichen Schutzrechten vor. Die gleichen Regelungen gelten für diesbezügliche mündliche Mitteilungen entsprechend.

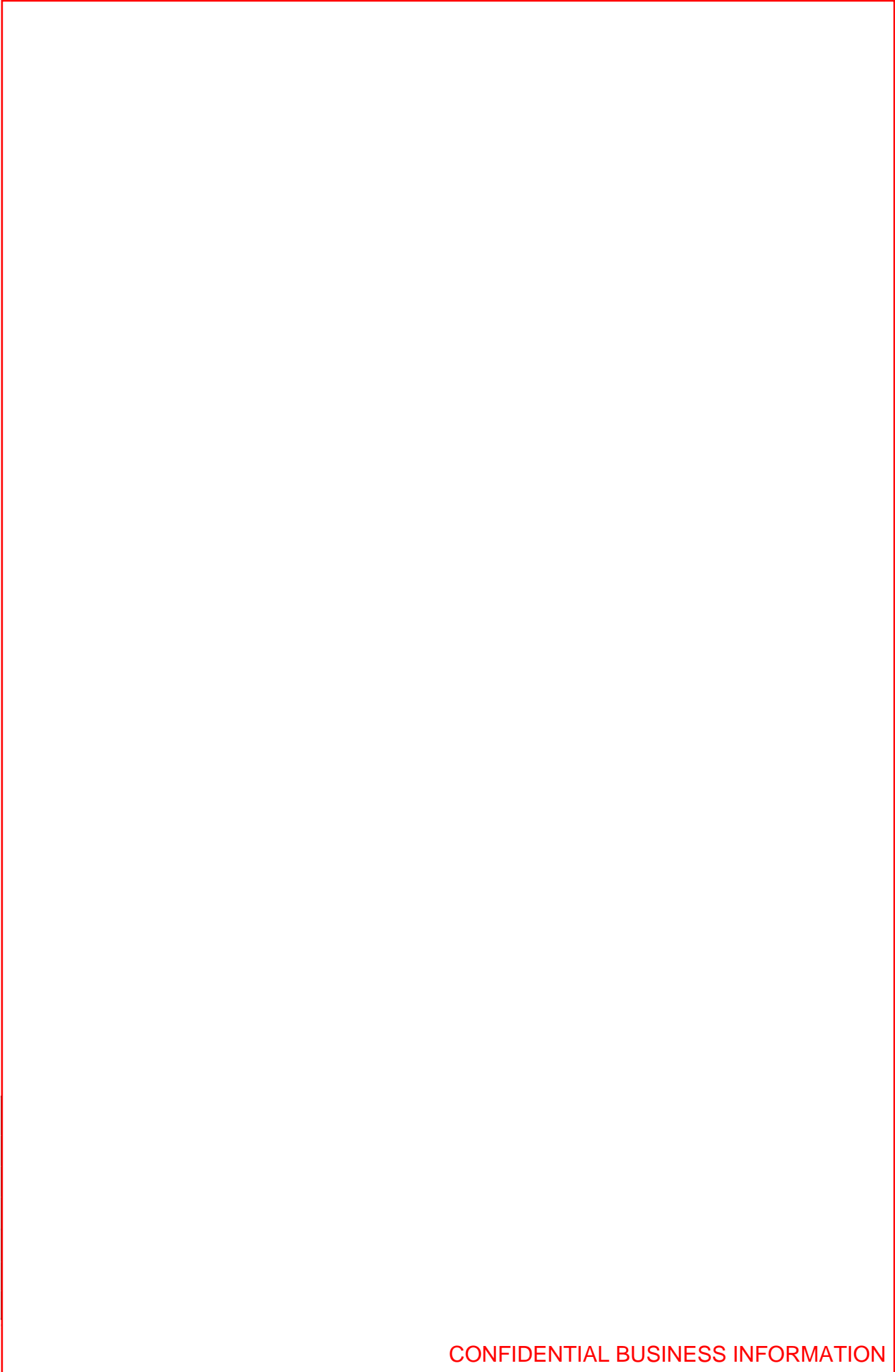

CONFIDENTIAL AND PROPRIETARY
This information carrier and the information it contains are the property of Continental Teves AG & Co. oHG (TEVES). Any reproduction, disclosure or use of either is prohibited without the prior written consent of TEVES. TEVES reserve worldwide all rights also in case of industrial property rights being granted. The same provisions apply to any oral communications related thereto accordingly.

PROPERTY OF CONTINENTAL TEVES AG & CO. OHG
ALL RIGHTS RESERVED



Customer Product Specification
MK25 Safety Concept
TOYOTA 532N ABS/EBD/BTRAC/ETRAC/VSC/HBA

ATE N 655 66.14
Sheet 152
Page 157 of 206

ALLE RECHTE VORBEHALTEN

EIGENTUM DER CONTINENTAL TEVES AG & CO. OHG

VERTRAULICH

Dieser Informationsträger und die darin enthaltenen Informationen sind Eigentum von Continental Teves AG & Co. oHG (TEVES). Jegliche Vervielfältigung, Offenbarung oder Benutzung dieser Informationen ist ohne vorherige schriftliche Zustimmung von TEVES verboten. TEVES behält sich weltweit alle Rechte auch für den Fall der Erteilung von gewerblichen Schutzrechten vor. Die gleichen Regelungen gelten für diesbezügliche mündliche Mitteilungen entsprechend.

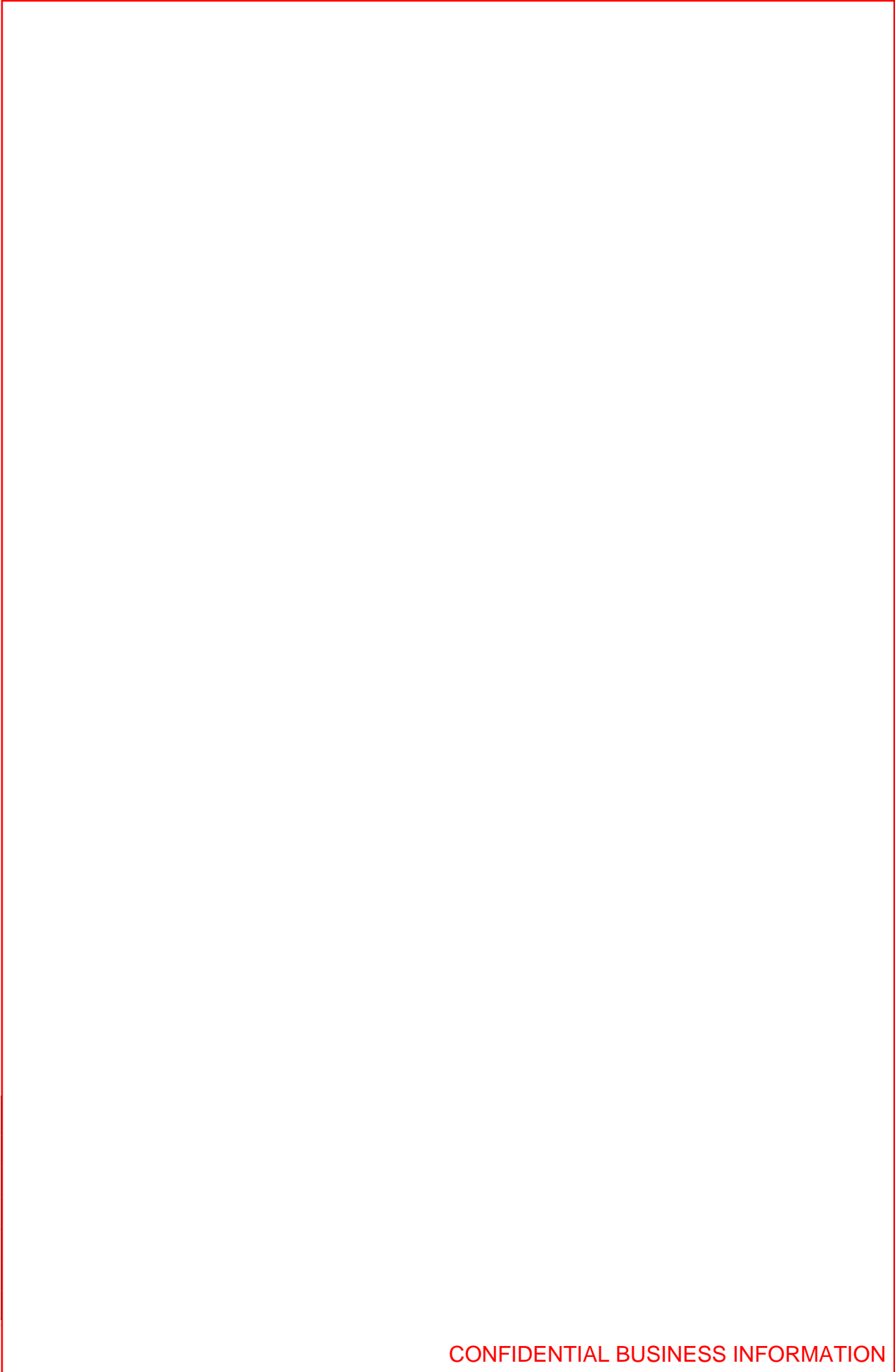

CONFIDENTIAL AND PROPRIETARY
This information carrier and the information it contains are the property of Continental Teves AG & Co. oHG (TEVES). Any reproduction, disclosure or use of either is prohibited without the prior written consent of TEVES. TEVES reserve worldwide all rights also in case of industrial property rights being granted. The same provisions apply to any oral communications related thereto accordingly.

PROPERTY OF CONTINENTAL TEVES AG & CO. OHG
ALL RIGHTS RESERVED



Customer Product Specification
MK25 Safety Concept
TOYOTA 532N ABS/EBD/BTRAC/ETRAC/VSC/HBA

ATE N 655 66.14
Sheet 152
Page 158 of 206

ALLE RECHTE VORBEHALTEN

EIGENTUM DER CONTINENTAL TEVES AG & CO. OHG

VERTRAULICH

Dieser Informationsträger und die darin enthaltenen Informationen sind Eigentum von Continental Teves AG & Co. oHG (TEVES). Jegliche Vervielfältigung, Offenbarung oder Benutzung dieser Informationen ist ohne vorherige schriftliche Zustimmung von TEVES verboten. TEVES behält sich weltweit alle Rechte auch für den Fall der Erteilung von gewerblichen Schutzrechten vor. Die gleichen Regelungen gelten für diesbezügliche mündliche Mitteilungen entsprechend.

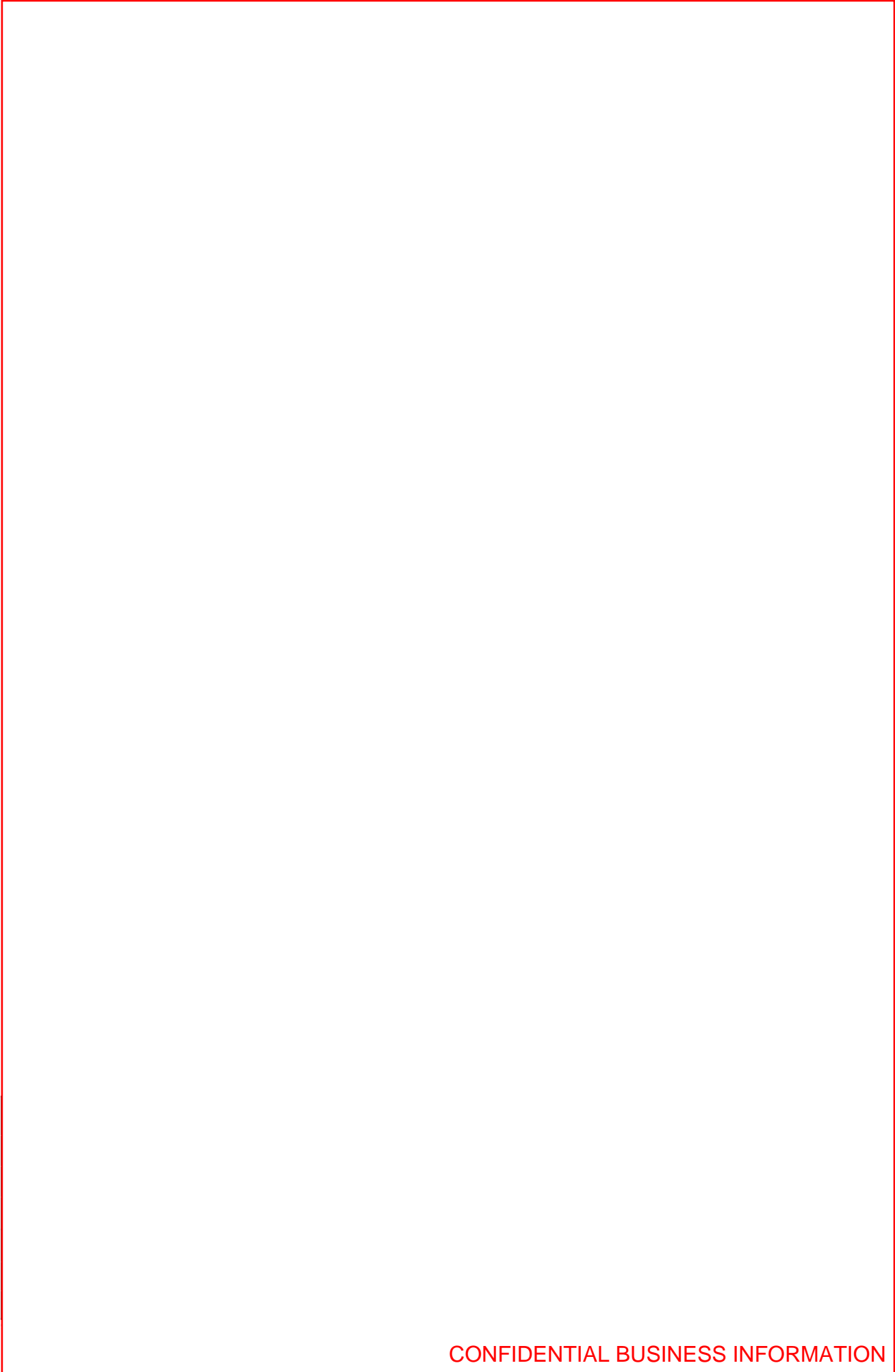



Customer Product Specification
MK25 Safety Concept
TOYOTA 532N ABS/EBD/BTRAC/ETRAC/VSC/HBA

ATE N 655 66.14
Sheet 152
Page 159 of 206

ALLE RECHTE VORBEHALTEN

EIGENTUM DER CONTINENTAL TEVES AG & CO. OHG

VERTRAULICH

Dieser Informationsträger und die darin enthaltenen Informationen sind Eigentum von Continental Teves AG & Co. oHG (TEVES). Jegliche Vervielfältigung, Offenbarung oder Benutzung dieser Informationen ist ohne vorherige schriftliche Zustimmung von TEVES verboten. TEVES behält sich weltweit alle Rechte auch für den Fall der Erteilung von gewerblichen Schutzrechten vor. Die gleichen Regelungen gelten für diesbezügliche mündliche Mitteilungen entsprechend.

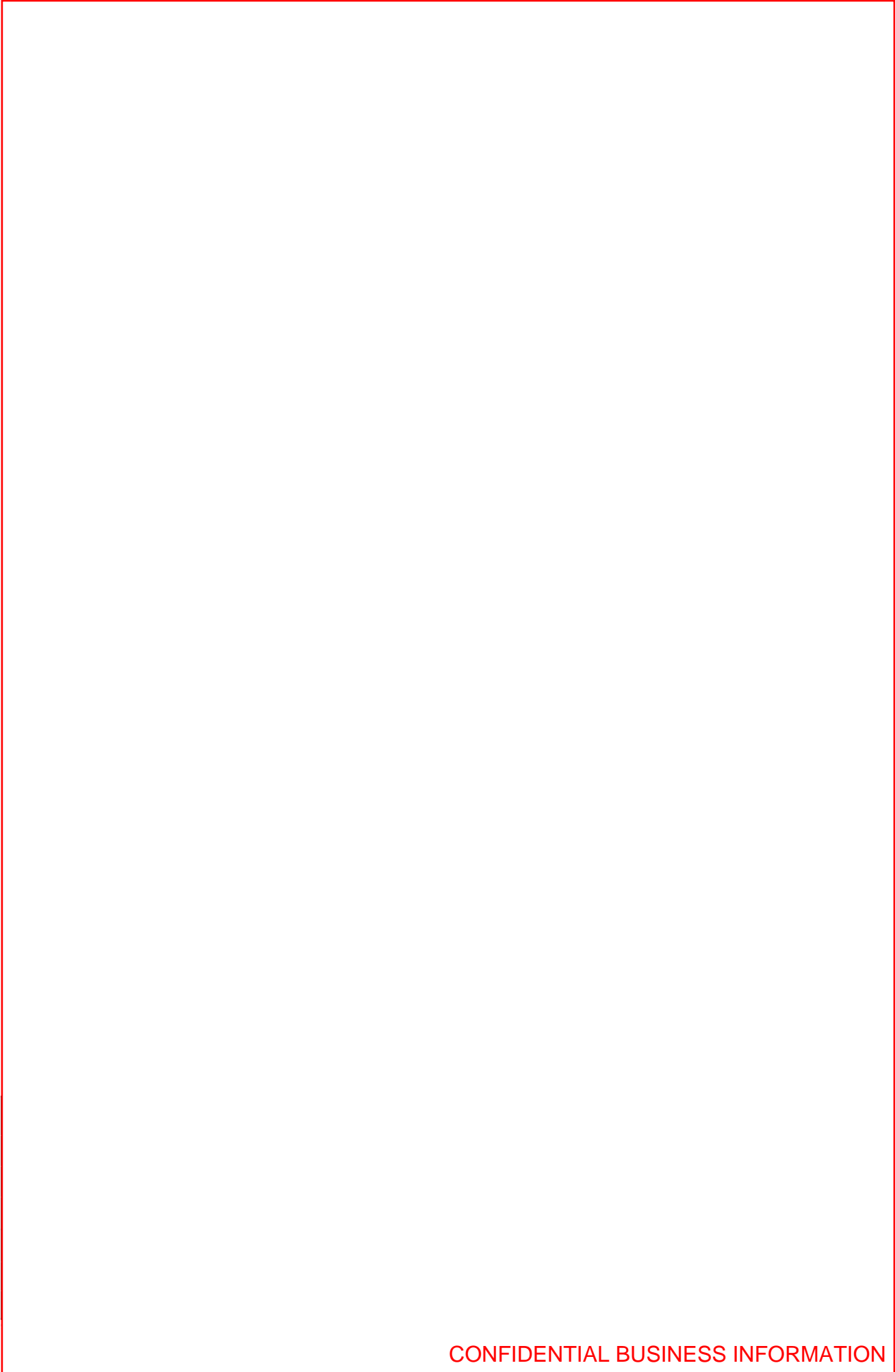

CONFIDENTIAL AND PROPRIETARY
This information carrier and the information it contains are the property of Continental Teves AG & Co. oHG (TEVES). Any reproduction, disclosure or use of either is prohibited without the prior written consent of TEVES. TEVES reserve worldwide all rights also in case of industrial property rights being granted. The same provisions apply to any oral communications related thereto accordingly.

PROPERTY OF CONTINENTAL TEVES AG & CO. OHG

ALL RIGHTS RESERVED



Customer Product Specification
MK25 Safety Concept
TOYOTA 532N ABS/EBD/BTRAC/ETRAC/VSC/HBA

ATE N 655 66.14
Sheet 152
Page 160 of 206

ALLE RECHTE VORBEHALTEN

EIGENTUM DER CONTINENTAL TEVES AG & CO. OHG

VERTRAULICH

Dieser Informationsträger und die darin enthaltenen Informationen sind Eigentum von Continental Teves AG & Co. oHG (TEVES). Jegliche Vervielfältigung, Offenbarung oder Benutzung dieser Informationen ist ohne vorherige schriftliche Zustimmung von TEVES verboten. TEVES behält sich weltweit alle Rechte auch für den Fall der Erteilung von gewerblichen Schutzrechten vor. Die gleichen Regelungen gelten für diesbezügliche mündliche Mitteilungen entsprechend.



CONFIDENTIAL AND PROPRIETARY
This information carrier and the information it contains are the property of Continental Teves AG & Co. oHG (TEVES). Any reproduction, disclosure or use of either is prohibited without the prior written consent of TEVES. TEVES reserve worldwide all rights also in case of industrial property rights being granted. The same provisions apply to any oral communications related thereto accordingly.

ALL RIGHTS RESERVED



Customer Product Specification
MK25 Safety Concept
TOYOTA 532N ABS/EBD/BTRAC/ETRAC/VSC/HBA

ATE N 655 66.14
Sheet 152
Page 162 of 206

ALLE RECHTE VORBEHALTEN

EIGENTUM DER CONTINENTAL TEVES AG & CO. OHG

VERTRAULICH

Dieser Informationsträger und die darin enthaltenen Informationen sind Eigentum von Continental Teves AG & Co. oHG (TEVES). Jegliche Vervielfältigung, Offenbarung oder Benutzung dieser Informationen ist ohne vorherige schriftliche Zustimmung von TEVES verboten. TEVES behält sich weltweit alle Rechte auch für den Fall der Erteilung von gewerblichen Schutzrechten vor. Die gleichen Regelungen gelten für diesbezügliche mündliche Mitteilungen entsprechend.

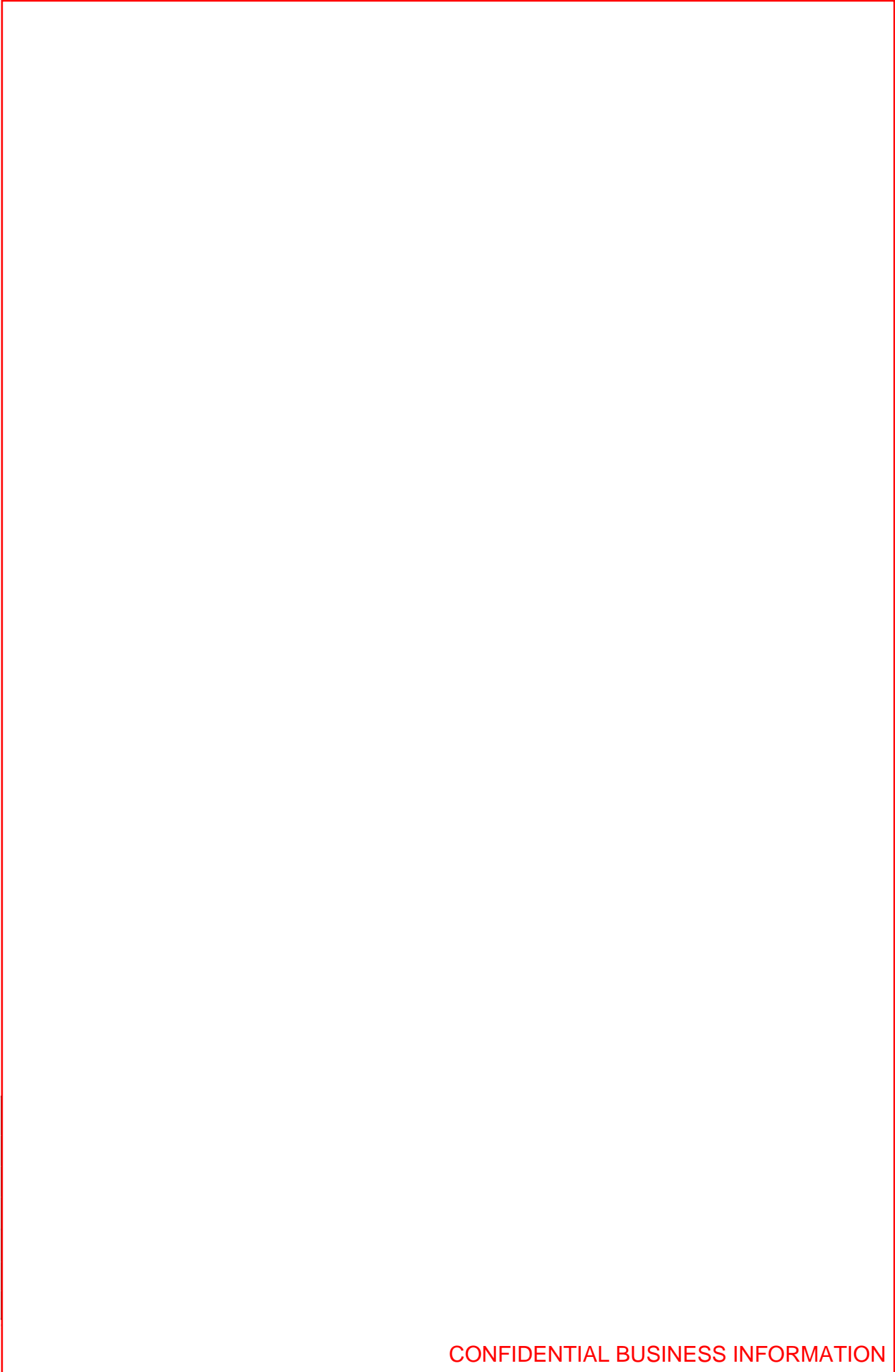



Customer Product Specification
MK25 Safety Concept
TOYOTA 532N ABS/EBD/BTRAC/ETRAC/VSC/HBA

ATE N 655 66.14
Sheet 152
Page 163 of 206

ALLE RECHTE VORBEHALTEN

EIGENTUM DER CONTINENTAL TEVES AG & CO. OHG

VERTRAULICH

Dieser Informationsträger und die darin enthaltenen Informationen sind Eigentum von Continental Teves AG & Co. oHG (TEVES). Jegliche Vervielfältigung, Offenbarung oder Benutzung dieser Informationen ist ohne vorherige schriftliche Zustimmung von TEVES verboten. TEVES behält sich weltweit alle Rechte auch für den Fall der Erteilung von gewerblichen Schutzrechten vor. Die gleichen Regelungen gelten für diesbezügliche mündliche Mitteilungen entsprechend.



CONFIDENTIAL AND PROPRIETARY
This information carrier and the information it contains are the property of Continental Teves AG & Co. oHG (TEVES). Any reproduction, disclosure or use of either is prohibited without the prior written consent of TEVES. TEVES reserve worldwide all rights also in case of industrial property rights being granted. The same provisions apply to any oral communications related thereto accordingly.



Customer Product Specification
MK25 Safety Concept
TOYOTA 532N ABS/EBD/BTRAC/ETRAC/VSC/HBA

ATE N 655 66.14
Sheet 152
Page 164 of 206

ALLE RECHTE VORBEHALTEN

EIGENTUM DER CONTINENTAL TEVES AG & CO. OHG

VERTRAULICH

Dieser Informationsträger und die darin enthaltenen Informationen sind Eigentum von Continental Teves AG & Co. oHG (TEVES). Jegliche Vervielfältigung, Offenbarung oder Benutzung dieser Informationen ist ohne vorherige schriftliche Zustimmung von TEVES verboten. TEVES behält sich weltweit alle Rechte auch für den Fall der Erteilung von gewerblichen Schutzrechten vor. Die gleichen Regelungen gelten für diesbezügliche mündliche Mitteilungen entsprechend.

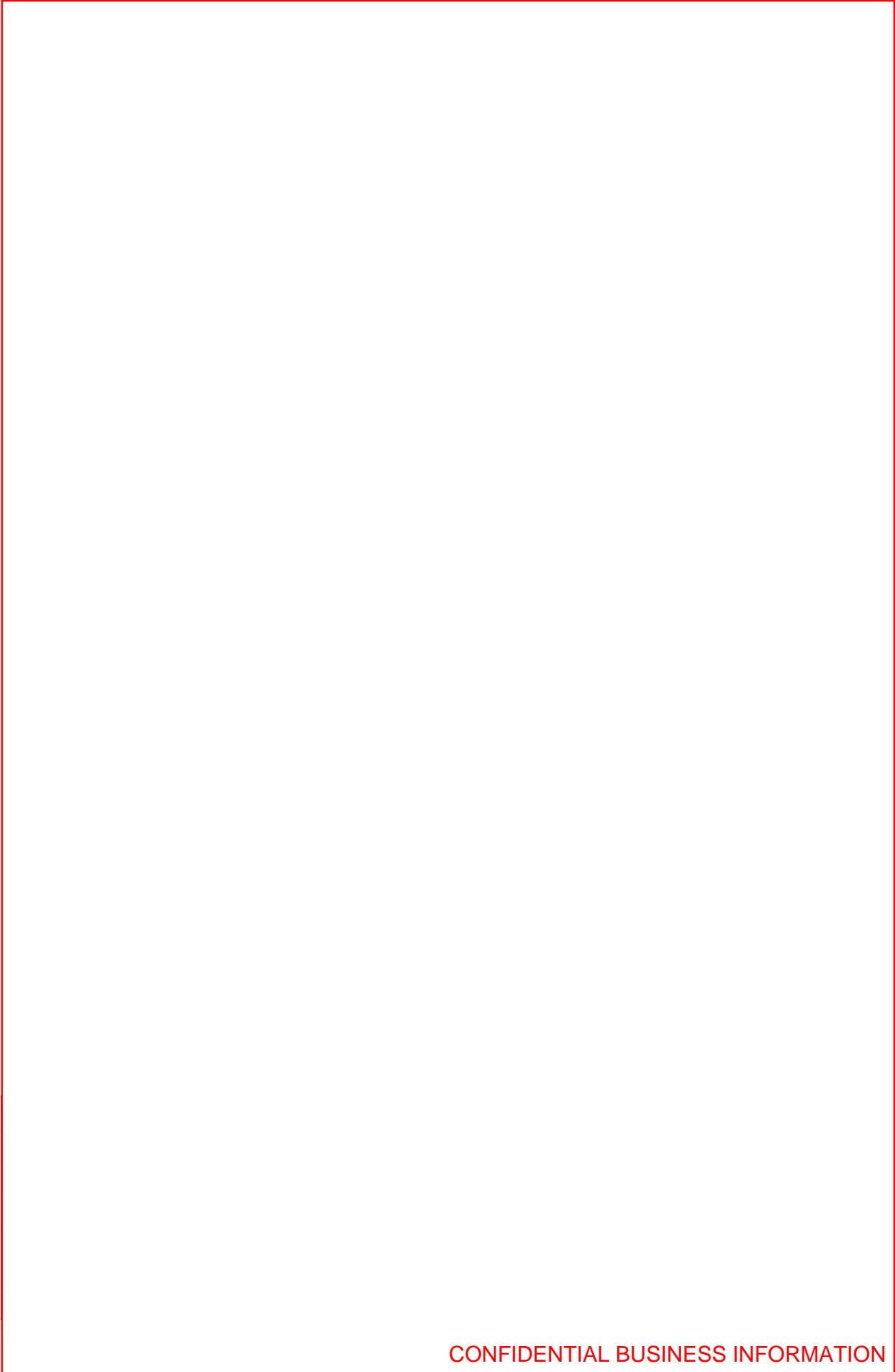

CONFIDENTIAL AND PROPRIETARY
This information carrier and the information it contains are the property of Continental Teves AG & Co. oHG (TEVES). Any reproduction, disclosure or use of either is prohibited without the prior written consent of TEVES. TEVES reserve worldwide all rights also in case of industrial property rights being granted. The same provisions apply to any oral communications related thereto accordingly.

PROPERTY OF CONTINENTAL TEVES AG & CO. OHG
ALL RIGHTS RESERVED



Customer Product Specification
MK25 Safety Concept
TOYOTA 532N ABS/EBD/BTRAC/ETRAC/VSC/HBA

ATE N 655 66.14
Sheet 152
Page 165 of 206

ALLE RECHTE VORBEHALTEN

EIGENTUM DER CONTINENTAL TEVES AG & CO. OHG

VERTRAULICH

Dieser Informationsträger und die darin enthaltenen Informationen sind Eigentum von Continental Teves AG & Co. oHG (TEVES). Jegliche Vervielfältigung, Offenbarung oder Benutzung dieser Informationen ist ohne vorherige schriftliche Zustimmung von TEVES verboten. TEVES behält sich weltweit alle Rechte auch für den Fall der Erteilung von gewerblichen Schutzrechten vor. Die gleichen Regelungen gelten für diesbezügliche mündliche Mitteilungen entsprechend.

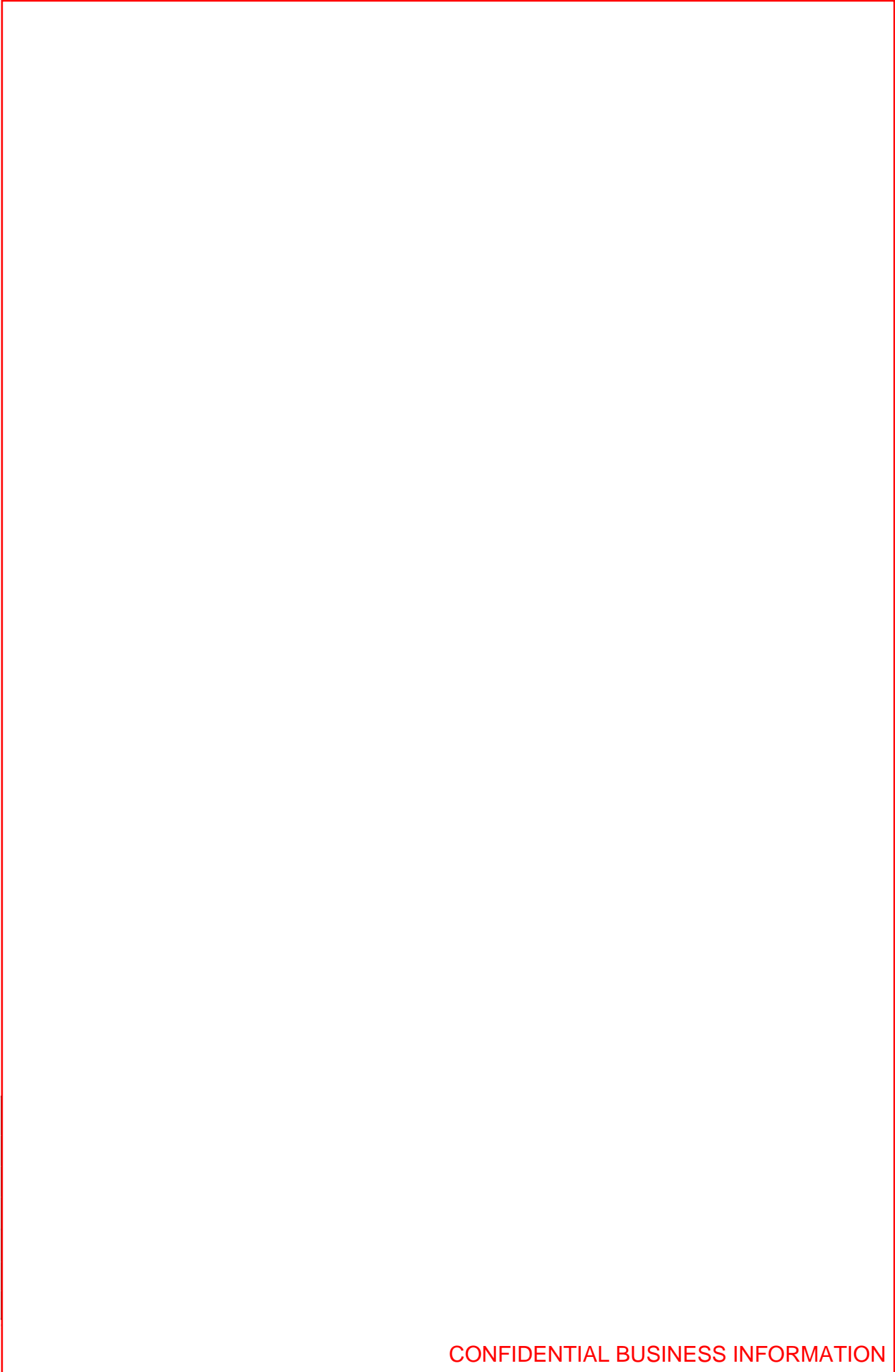

CONFIDENTIAL AND PROPRIETARY
This information carrier and the information it contains are the property of Continental Teves AG & Co. oHG (TEVES). Any reproduction, disclosure or use of either is prohibited without the prior written consent of TEVES. TEVES reserve worldwide all rights also in case of industrial property rights being granted. The same provisions apply to any oral communications related thereto accordingly.



Customer Product Specification
MK25 Safety Concept
TOYOTA 532N ABS/EBD/BTRAC/ETRAC/VSC/HBA

ATE N 655 66.14
Sheet 152
Page 166 of 206

ALLE RECHTE VORBEHALTEN

EIGENTUM DER CONTINENTAL TEVES AG & CO. OHG

VERTRAULICH

Dieser Informationsträger und die darin enthaltenen Informationen sind Eigentum von Continental Teves AG & Co. oHG (TEVES). Jegliche Vervielfältigung, Offenbarung oder Benutzung dieser Informationen ist ohne vorherige schriftliche Zustimmung von TEVES verboten. TEVES behält sich weltweit alle Rechte auch für den Fall der Erteilung von gewerblichen Schutzrechten vor. Die gleichen Regelungen gelten für diesbezügliche mündliche Mitteilungen entsprechend.

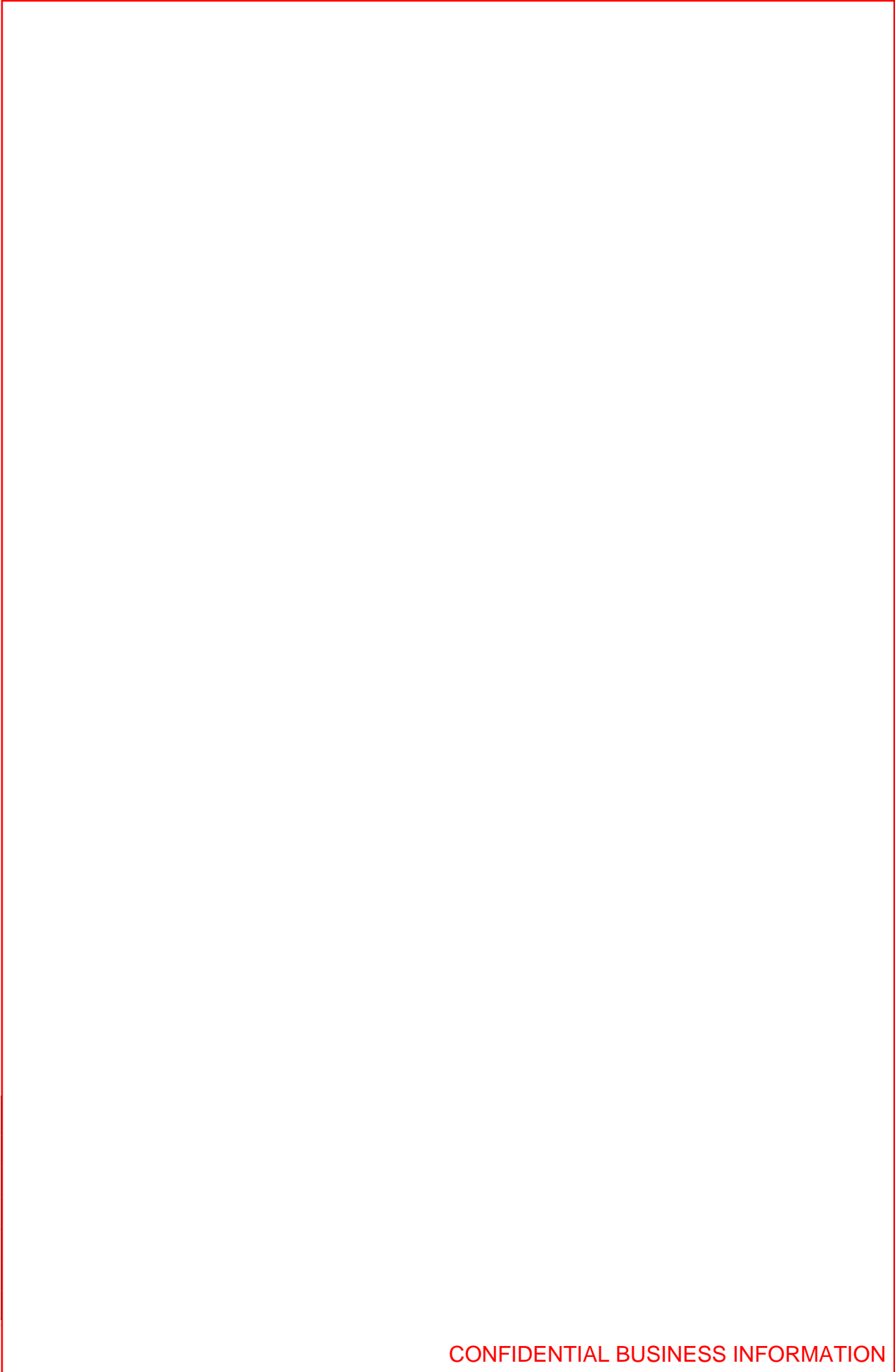



Customer Product Specification
MK25 Safety Concept
TOYOTA 532N ABS/EBD/BTRAC/ETRAC/VSC/HBA

ATE N 655 66.14
Sheet 152
Page 167 of 206

ALLE RECHTE VORBEHALTEN

EIGENTUM DER CONTINENTAL TEVES AG & CO. OHG

VERTRAULICH

Dieser Informationsträger und die darin enthaltenen Informationen sind Eigentum von Continental Teves AG & Co. oHG (TEVES). Jegliche Vervielfältigung, Offenbarung oder Benutzung dieser Informationen ist ohne vorherige schriftliche Zustimmung von TEVES verboten. TEVES behält sich weltweit alle Rechte auch für den Fall der Erteilung von gewerblichen Schutzrechten vor. Die gleichen Regelungen gelten für diesbezügliche mündliche Mitteilungen entsprechend.





Customer Product Specification
MK25 Safety Concept
TOYOTA 532N ABS/EBD/BTRAC/ETRAC/VSC/HBA

ATE N 655 66.14
Sheet 152
Page 168 of 206

ALLE RECHTE VORBEHALTEN

EIGENTUM DER CONTINENTAL TEVES AG & CO. OHG

VERTRAULICH

Dieser Informationsträger und die darin enthaltenen Informationen sind Eigentum von Continental Teves AG & Co. oHG (TEVES). Jegliche Vervielfältigung, Offenbarung oder Benutzung dieser Informationen ist ohne vorherige schriftliche Zustimmung von TEVES verboten. TEVES behält sich weltweit alle Rechte auch für den Fall der Erteilung von gewerblichen Schutzrechten vor. Die gleichen Regelungen gelten für diesbezügliche mündliche Mitteilungen entsprechend.

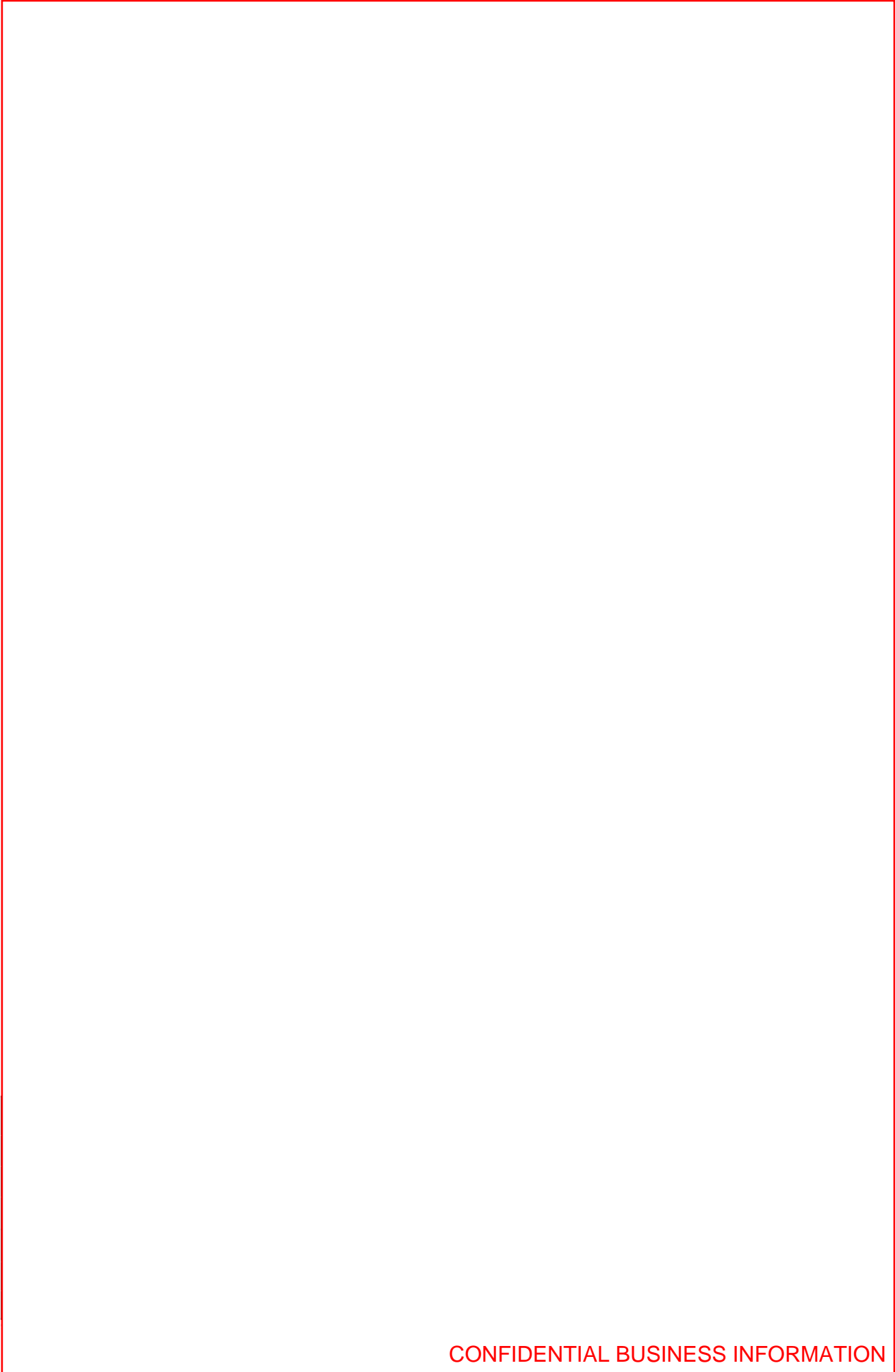

CONFIDENTIAL AND PROPRIETARY
This information carrier and the information it contains are the property of Continental Teves AG & Co. oHG (TEVES). Any reproduction, disclosure or use of either is prohibited without the prior written consent of TEVES. TEVES reserve worldwide all rights also in case of industrial property rights being granted. The same provisions apply to any oral communications related thereto accordingly.



Customer Product Specification
MK25 Safety Concept
TOYOTA 532N ABS/EBD/BTRAC/ETRAC/VSC/HBA

ATE N 655 66.14
Sheet 152
Page 169 of 206

ALLE RECHTE VORBEHALTEN

EIGENTUM DER CONTINENTAL TEVES AG & CO. OHG

VERTRAULICH

Dieser Informationsträger und die darin enthaltenen Informationen sind Eigentum von Continental Teves AG & Co. oHG (TEVES). Jegliche Vervielfältigung, Offenbarung oder Benutzung dieser Informationen ist ohne vorherige schriftliche Zustimmung von TEVES verboten. TEVES behält sich weltweit alle Rechte auch für den Fall der Erteilung von gewerblichen Schutzrechten vor. Die gleichen Regelungen gelten für diesbezügliche mündliche Mitteilungen entsprechend.



CONFIDENTIAL AND PROPRIETARY
This information carrier and the information it contains are the property of Continental Teves AG & Co. oHG (TEVES). Any reproduction, disclosure or use of either is prohibited without the prior written consent of TEVES. TEVES reserve worldwide all rights also in case of industrial property rights being granted. The same provisions apply to any oral communications related thereto accordingly.



Customer Product Specification
MK25 Safety Concept
TOYOTA 532N ABS/EBD/BTRAC/ETRAC/VSC/HBA

ATE N 655 66.14
Sheet 152
Page 170 of 206

ALLE RECHTE VORBEHALTEN

EIGENTUM DER CONTINENTAL TEVES AG & CO. OHG

VERTRAULICH

Dieser Informationsträger und die darin enthaltenen Informationen sind Eigentum von Continental Teves AG & Co. oHG (TEVES). Jegliche Vervielfältigung, Offenbarung oder Benutzung dieser Informationen ist ohne vorherige schriftliche Zustimmung von TEVES verboten. TEVES behält sich weltweit alle Rechte auch für den Fall der Erteilung von gewerblichen Schutzrechten vor. Die gleichen Regelungen gelten für diesbezügliche mündliche Mitteilungen entsprechend.

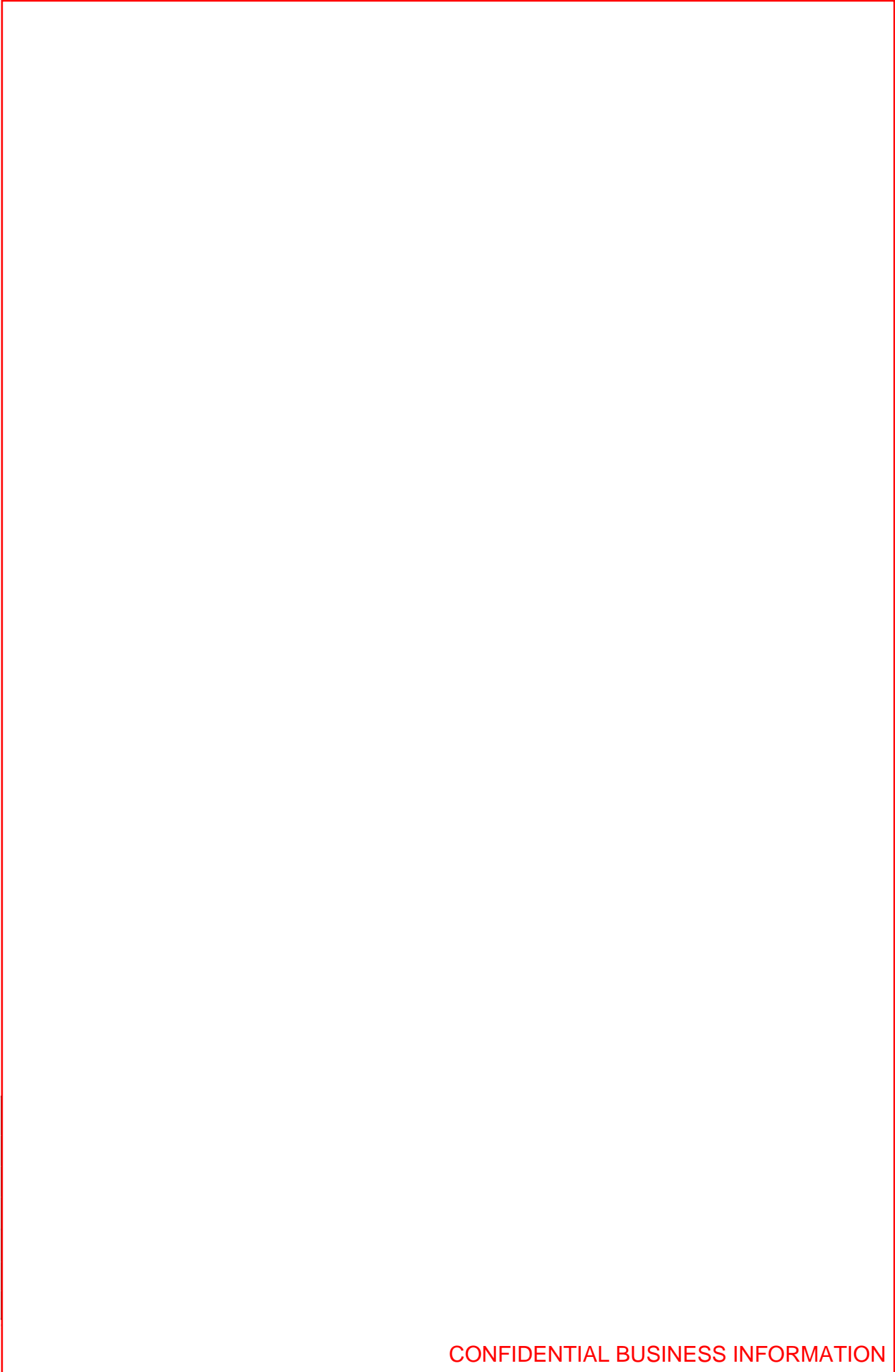

CONFIDENTIAL AND PROPRIETARY
This information carrier and the information it contains are the property of Continental Teves AG & Co. oHG (TEVES). Any reproduction, disclosure or use of either is prohibited without the prior written consent of TEVES. TEVES reserve worldwide all rights also in case of industrial property rights being granted. The same provisions apply to any oral communications related thereto accordingly.



Customer Product Specification
MK25 Safety Concept
TOYOTA 532N ABS/EBD/BTRAC/ETRAC/VSC/HBA

ATE N 655 66.14
Sheet 152
Page 171 of 206

ALLE RECHTE VORBEHALTEN

EIGENTUM DER CONTINENTAL TEVES AG & CO. OHG

VERTRAULICH

Dieser Informationsträger und die darin enthaltenen Informationen sind Eigentum von Continental Teves AG & Co. oHG (TEVES). Jegliche Vervielfältigung, Offenbarung oder Benutzung dieser Informationen ist ohne vorherige schriftliche Zustimmung von TEVES verboten. TEVES behält sich weltweit alle Rechte auch für den Fall der Erteilung von gewerblichen Schutzrechten vor. Die gleichen Regelungen gelten für diesbezügliche mündliche Mitteilungen entsprechend.



CONFIDENTIAL AND PROPRIETARY
This information carrier and the information it contains are the property of Continental Teves AG & Co. oHG (TEVES). Any reproduction, disclosure or use of either is prohibited without the prior written consent of TEVES. TEVES reserve worldwide all rights also in case of industrial property rights being granted. The same provisions apply to any oral communications related thereto accordingly.



Customer Product Specification
MK25 Safety Concept
TOYOTA 532N ABS/EBD/BTRAC/ETRAC/VSC/HBA

ATE N 655 66.14
Sheet 152
Page 172 of 206

ALLE RECHTE VORBEHALTEN

EIGENTUM DER CONTINENTAL TEVES AG & CO. OHG

VERTRAULICH

Dieser Informationsträger und die darin enthaltenen Informationen sind Eigentum von Continental Teves AG & Co. oHG (TEVES). Jegliche Vervielfältigung, Offenbarung oder Benutzung dieser Informationen ist ohne vorherige schriftliche Zustimmung von TEVES verboten. TEVES behält sich weltweit alle Rechte auch für den Fall der Erteilung von gewerblichen Schutzrechten vor. Die gleichen Regelungen gelten für diesbezügliche mündliche Mitteilungen entsprechend.

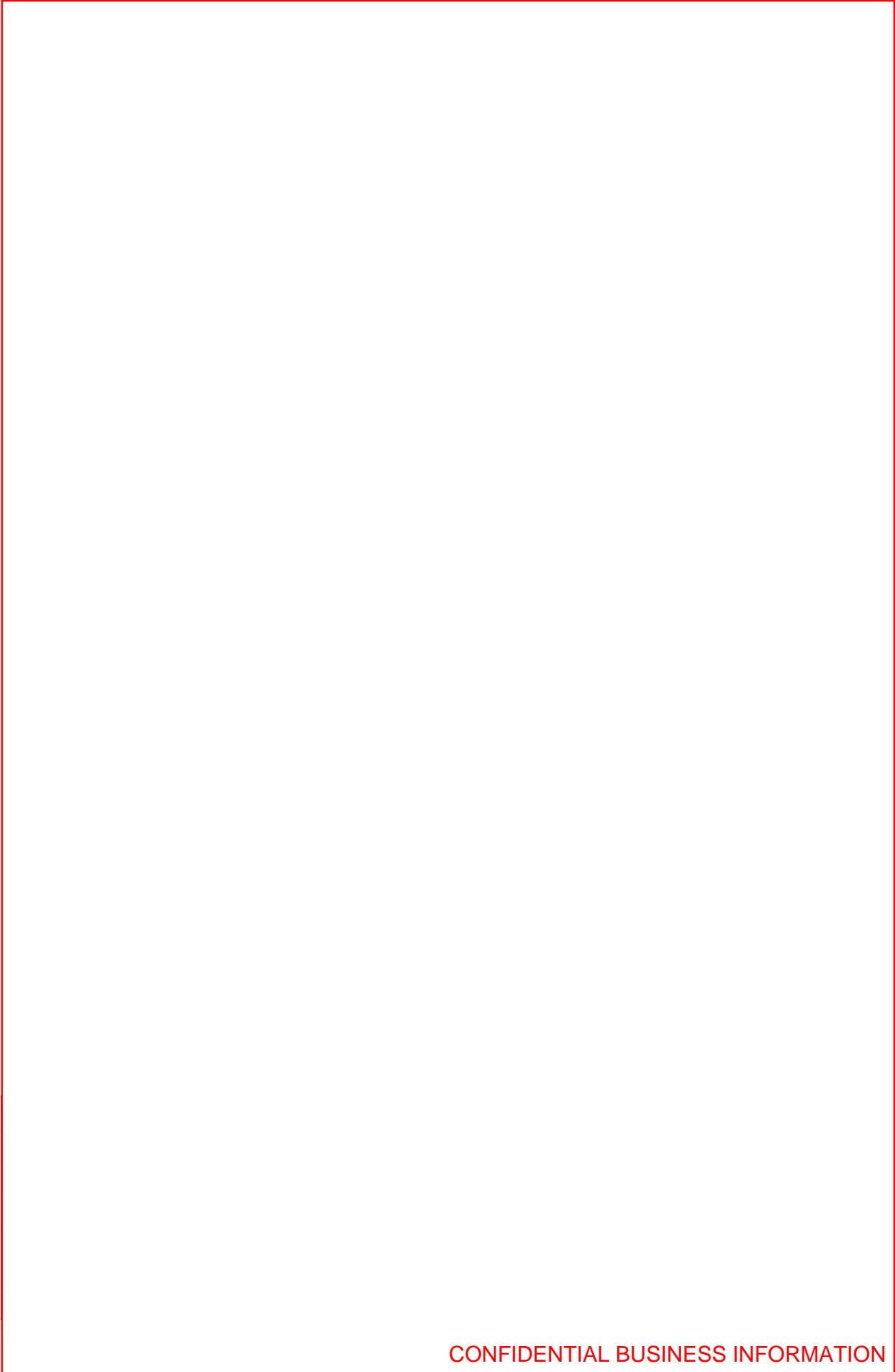

CONFIDENTIAL AND PROPRIETARY
This information carrier and the information it contains are the property of Continental Teves AG & Co. oHG (TEVES). Any reproduction, disclosure or use of either is prohibited without the prior written consent of TEVES. TEVES reserve worldwide all rights also in case of industrial property rights being granted. The same provisions apply to any oral communications related thereto accordingly.

PROPERTY OF CONTINENTAL TEVES AG & CO. OHG

ALL RIGHTS RESERVED



Customer Product Specification
MK25 Safety Concept
TOYOTA 532N ABS/EBD/BTRAC/ETRAC/VSC/HBA

ATE N 655 66.14
Sheet 152
Page 175 of 206

ALLE RECHTE VORBEHALTEN

EIGENTUM DER CONTINENTAL TEVES AG & CO. OHG

VERTRAULICH

Dieser Informationsträger und die darin enthaltenen Informationen sind Eigentum von Continental Teves AG & Co. oHG (TEVES). Jegliche Vervielfältigung, Offenbarung oder Benutzung dieser Informationen ist ohne vorherige schriftliche Zustimmung von TEVES verboten. TEVES behält sich weltweit alle Rechte auch für den Fall der Erteilung von gewerblichen Schutzrechten vor. Die gleichen Regelungen gelten für diesbezügliche mündliche Mitteilungen entsprechend.

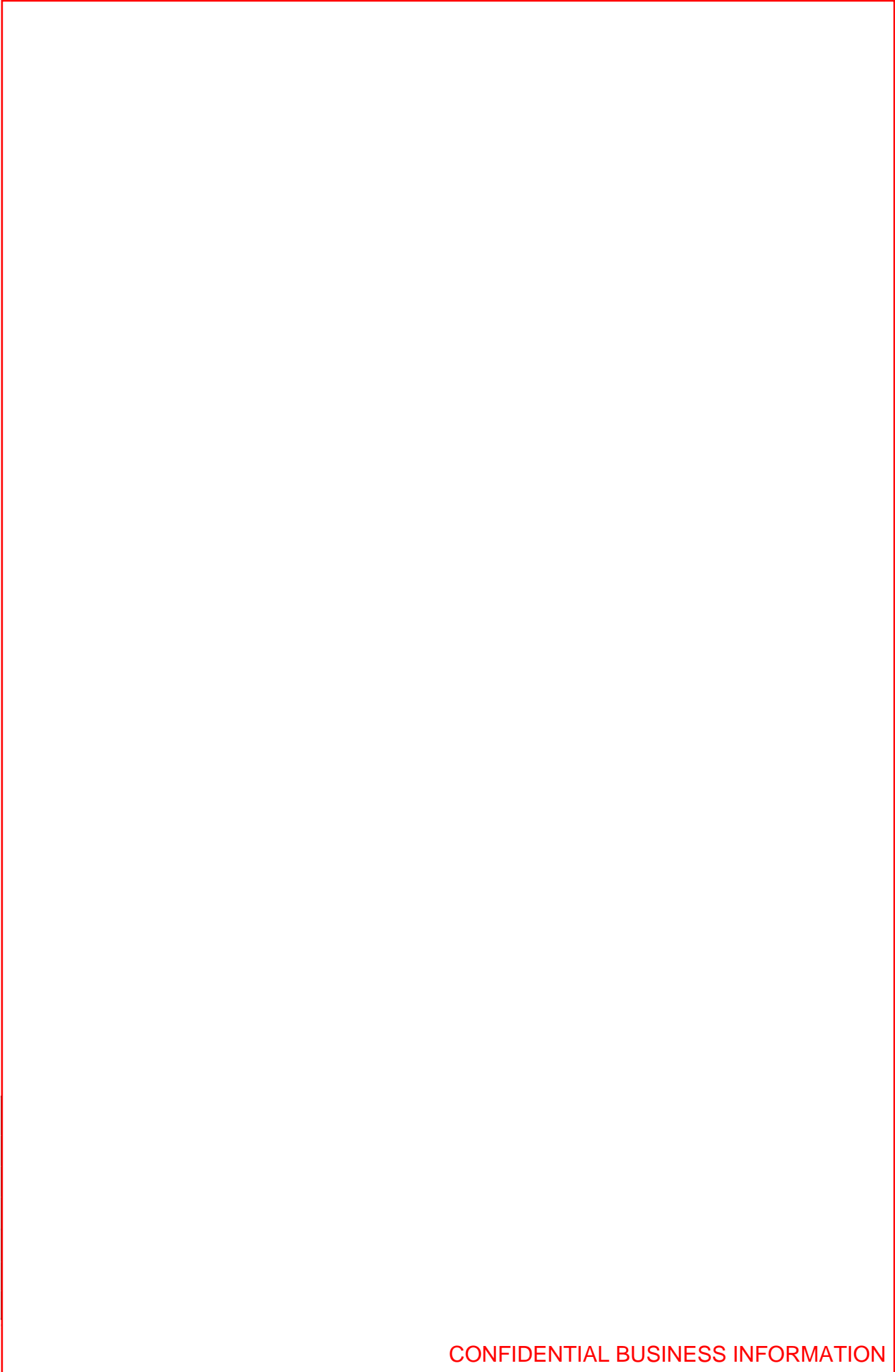



Customer Product Specification
MK25 Safety Concept
TOYOTA 532N ABS/EBD/BTRAC/ETRAC/VSC/HBA

ATE N 655 66.14
Sheet 152
Page 176 of 206

ALLE RECHTE VORBEHALTEN

EIGENTUM DER CONTINENTAL TEVES AG & CO. OHG

VERTRAULICH

Dieser Informationsträger und die darin enthaltenen Informationen sind Eigentum von Continental Teves AG & Co. oHG (TEVES). Jegliche Vervielfältigung, Offenbarung oder Benutzung dieser Informationen ist ohne vorherige schriftliche Zustimmung von TEVES verboten. TEVES behält sich weltweit alle Rechte auch für den Fall der Erteilung von gewerblichen Schutzrechten vor. Die gleichen Regelungen gelten für diesbezügliche mündliche Mitteilungen entsprechend.

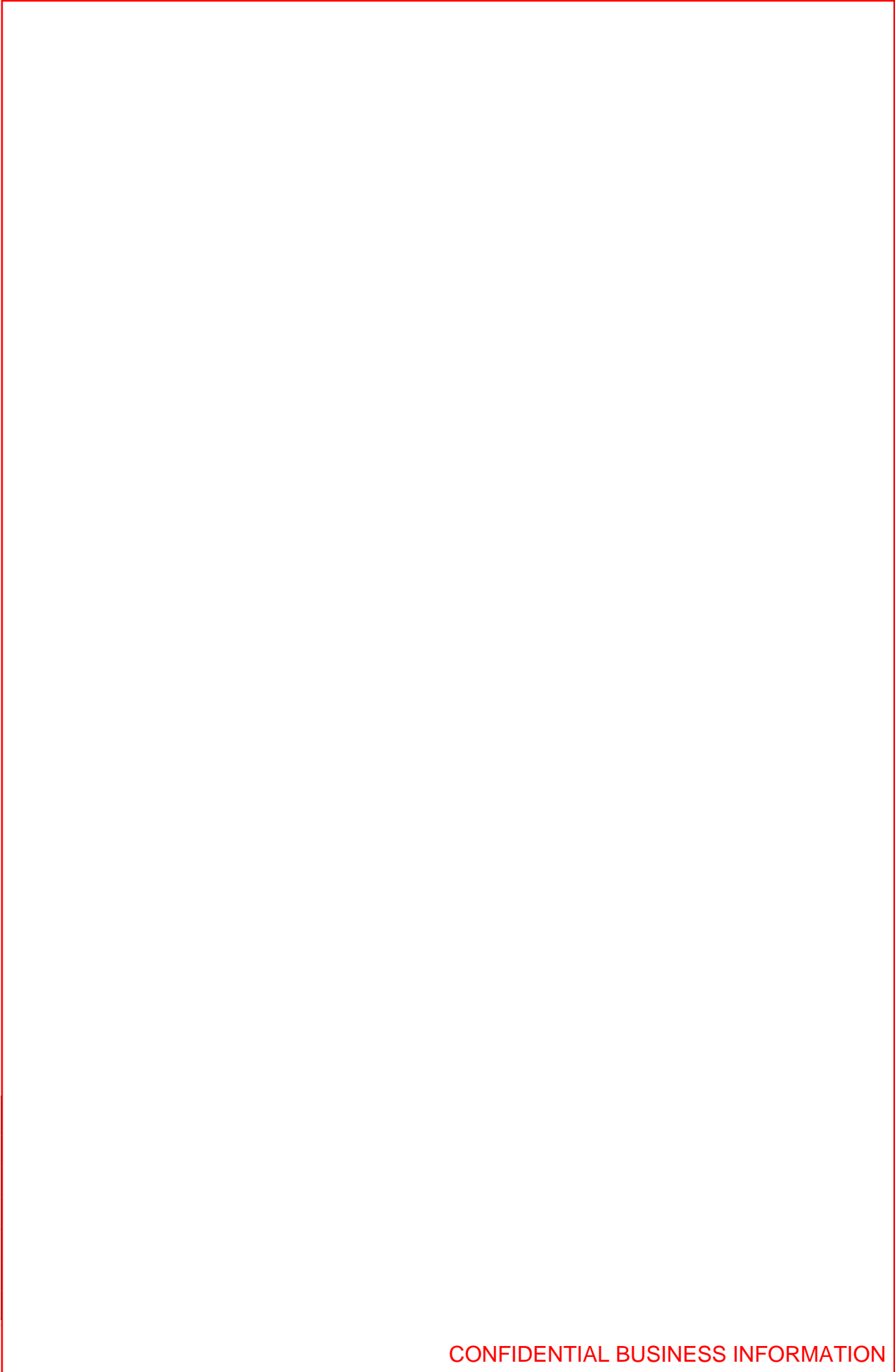



Customer Product Specification
MK25 Safety Concept
TOYOTA 532N ABS/EBD/BTRAC/ETRAC/VSC/HBA

ATE N 655 66.14
Sheet 152
Page 177 of 206

ALLE RECHTE VORBEHALTEN

EIGENTUM DER CONTINENTAL TEVES AG & CO. OHG

VERTRAULICH

Dieser Informationsträger und die darin enthaltenen Informationen sind Eigentum von Continental Teves AG & Co. oHG (TEVES). Jegliche Vervielfältigung, Offenbarung oder Benutzung dieser Informationen ist ohne vorherige schriftliche Zustimmung von TEVES verboten. TEVES behält sich weltweit alle Rechte auch für den Fall der Erteilung von gewerblichen Schutzrechten vor. Die gleichen Regelungen gelten für diesbezügliche mündliche Mitteilungen entsprechend.

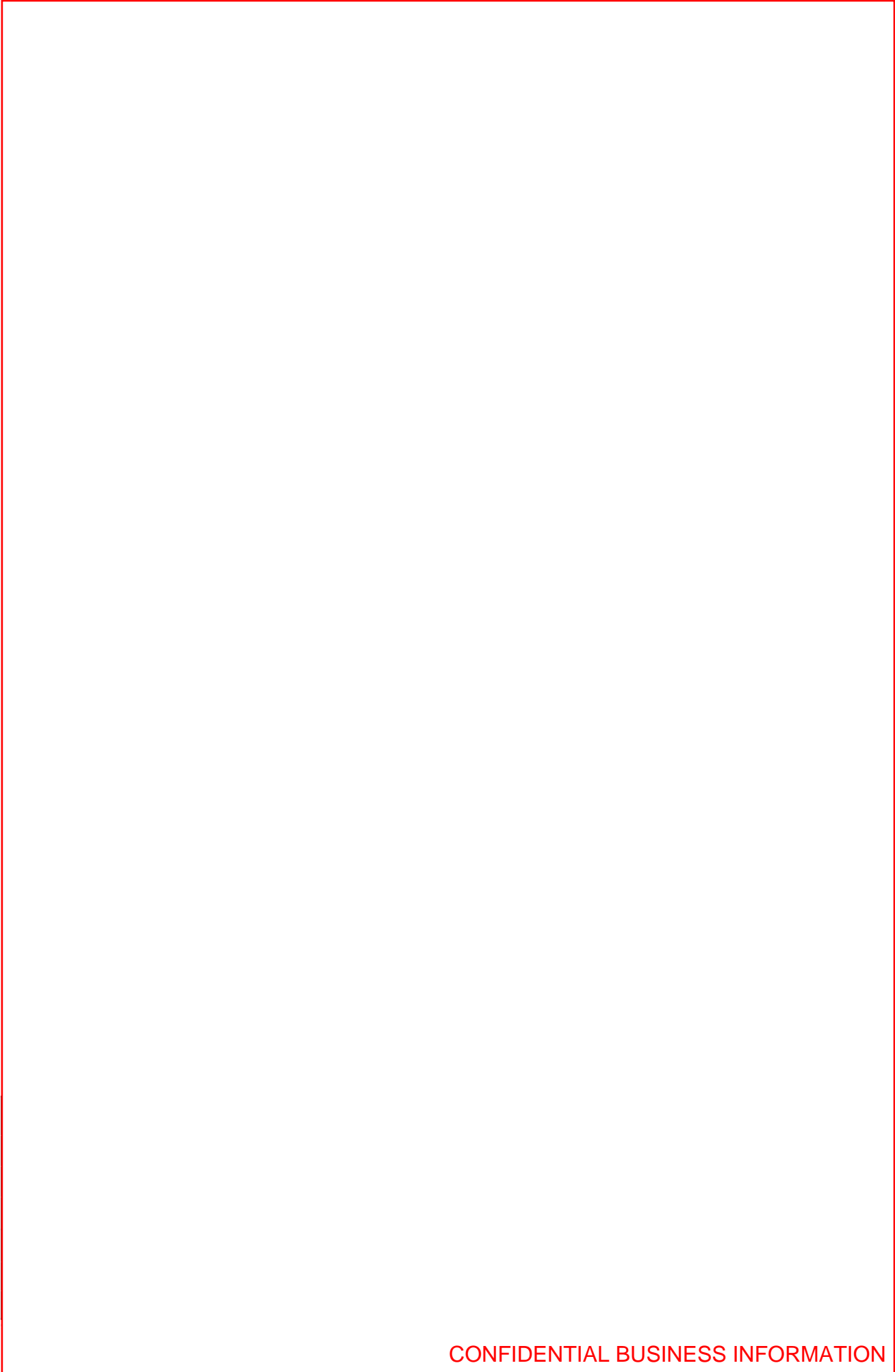

CONFIDENTIAL AND PROPRIETARY
This information carrier and the information it contains are the property of Continental Teves AG & Co. oHG (TEVES). Any reproduction, disclosure or use of either is prohibited without the prior written consent of TEVES. TEVES reserve worldwide all rights also in case of industrial property rights being granted. The same provisions apply to any oral communications related thereto accordingly.

	<p>Customer Product Specification MK25 Safety Concept TOYOTA 532N ABS/EBD/BTRAC/ETRAC/VSC/HBA</p>	<p>ATE N 655 66.14 Sheet 152 Page 181 of 206</p>
--	---	--

ALLE RECHTE VORBEHALTEN

EIGENTUM DER CONTINENTAL TEVES AG & CO. OHG

VERTRAULICH

Dieser Informationsträger und die darin enthaltenen Informationen sind Eigentum von Continental Teves AG & Co. oHG (TEVES). Jegliche Vervielfältigung, Offenbarung oder Benutzung dieser Informationen ist ohne vorherige schriftliche Zustimmung von TEVES verboten. TEVES behält sich weltweit alle Rechte auch für den Fall der Erteilung von gewerblichen Schutzrechten vor. Die gleichen Regelungen gelten für diesbezügliche mündliche Mitteilungen entsprechend.

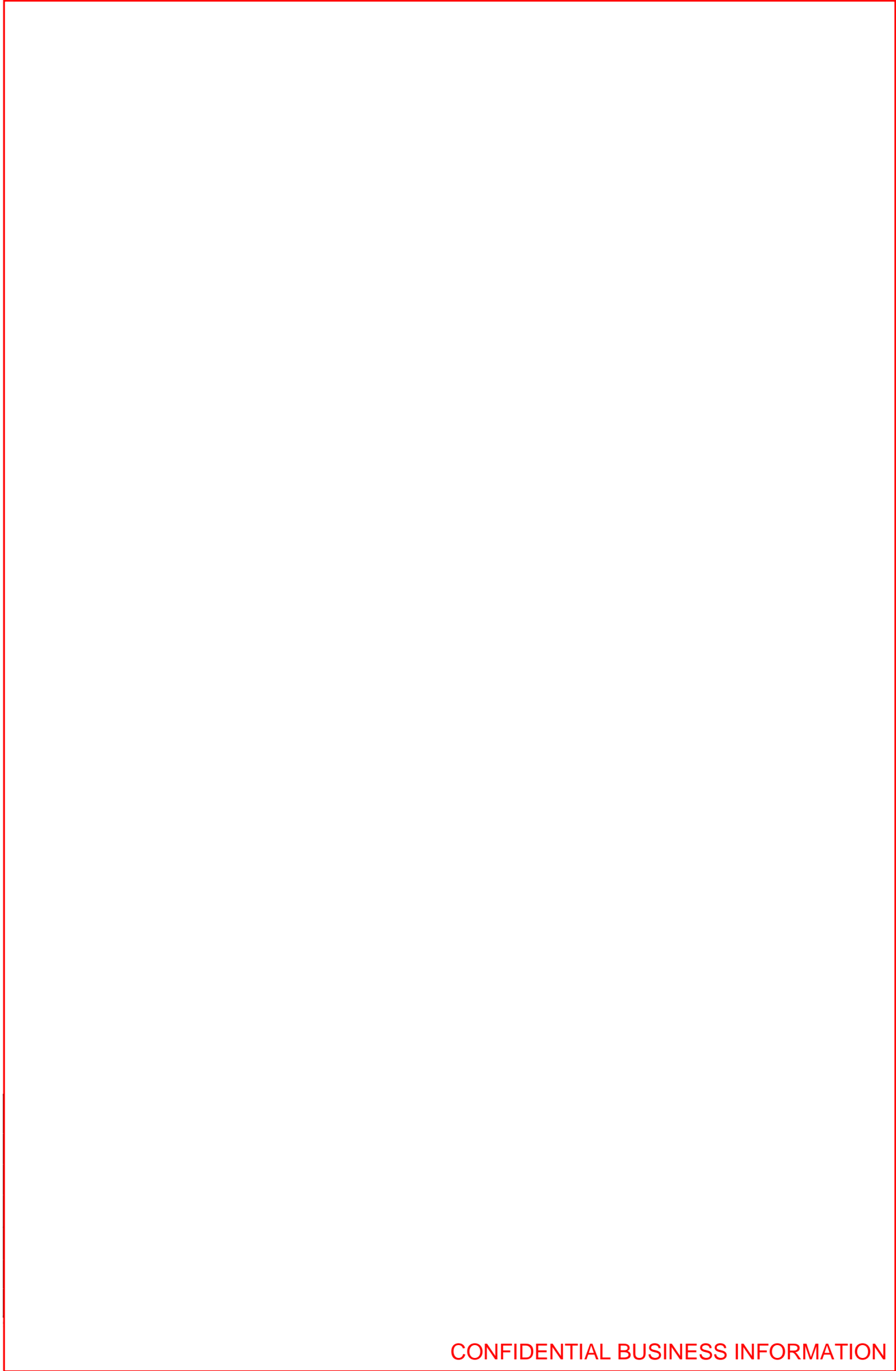

CONFIDENTIAL AND PROPRIETARY
 This information carrier and the information it contains are the property of Continental Teves AG & Co. oHG (TEVES). Any reproduction, disclosure or use of either is prohibited without the prior written consent of TEVES. TEVES reserve worldwide all rights also in case of industrial property rights being granted. The same provisions apply to any oral communications related thereto accordingly.

PROPERTY OF CONTINENTAL TEVES AG & CO. OHG
 ALL RIGHTS RESERVED

EA09-006

TOYOTA

2/19/2010

ATTACHMENT 11

11-F-2

532N VSC/TRC, Diagnosis code and system failure chart

1. ABS Diagnostic code

2. VSC Diagnostic code

3. Lamp/Buzzer concept

EA09-006

TOYOTA

2/19/2010

ATTACHMENT 11

11-G

Description of the VSC/TRC system self diagnostics:

EA09-006

TOYOTA

2/19/2010

ATTACHMENT 11

11-H

Water Intrusion into Rear Axle Housing

Water Intrusion into Rear Axle Housing

Water Intrusion into Rear Axle Housing

Wheel Speed Sensor Mechanism

Rear Wheel Speed Sensor Issue

Rear Wheel Speed Sensor Issue

EA09-006

TOYOTA

2/19/2010

ATTACHMENT 11

11-I

CONFIDENTIAL BUSINESS INFORMATION

Attachment-Response 11-i

Maximum duration of the VSC/TRAC activation on the subject vehicles:

CONFIDENTIAL BUSINESS INFORMATION