

Complete Service Request Report



SUBARU

Information

SR # 1-75186548

Last Name

VIN 5S

Status Closed

First Name Joanita

Model Baja

Source Phone

Primary Phone

Year 2005

Attachments Y

Region #

SR Mileage 99111

Alert

Dealer Name Sonora Subaru

Manufactured 04/14/2005

Description Faulty Fuel Delivery hose

Case Creator MCRE

Case Owner MCRE

Closed By CBAL

Created Date 08/15/2008 16:53:57

Last Modified Date 09/16/2008 10:53:02

Last Modified By CBAL

Address

Primary Address

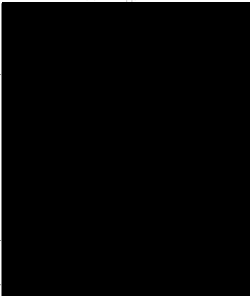

Last Modified By DADMIN

City

Created By DADMIN

State

Created Date 11/26/2007 21:59:58

ZipCode

Last Modified Date 08/28/2008 20:52:08



Complete Service Request Report

Attachments

Attachment Name 2ba45f6f-8b8b-430c-a70e-6ea84bb2e27b
 Type pdf
 Comment

Attachments

Attachment Name 9a2eab32-de54-42fe-b6db-7aab1c890dff0
 Type pdf
 Comment

Issues

Type	Vehicle	Last Modified Date	08/15/2008 17:01:17	Created By	MCRE
Area	Fuel System	Last Modified By	MCRE		
Sub-Area	General	Created	08/15/2008 16:56:25		

Notes

Date Created 09/16/2008 10:52:18
 Created By CBAL
 Notes customer called. transferred to rep

Complete Service Request Report



SUBARU

Notes

Date Created 09/16/2008 10:31:58

Created By MCRE

Notes customer called : advised can not offer any GW assistance at this time due to the mileage on the vehicle . Customer stated she will never buy another subaru . Apologized to the customer

Notes

Date Created 09/15/2008 16:17:17

Created By MCRE

Notes called customer : left message on voicemail

Notes

Date Created 09/15/2008 15:45:39

Created By MCRE

Notes reviewed with TI - not offering any GW assistance at this time

Complete Service Request Report



SUBARU

Notes

Date Created 09/15/2008 14:36:52

Created By MCRE

Notes

called dealer : spoke with SM states tech lifted the back seat and noticed a crack in the plastic housing of the fuel delivery house which caused the fuel to pump out near the electrical wiring . Sm states he has never seen anything this bad before

Notes

Date Created 08/29/2008 15:07:31

Created By MCRE

Notes

called dealer ; :left message for SM andy requesting a callback .

Notes

Date Created 08/27/2008 10:28:00

Created By KMIL

Notes

cust called, dlr inspected and directed cust to send in ro bc they feel issue is defect. cust will fax to 3016, cust feels vehicle was a bomb very dangerous to drive and is requesting assistance otherwise she will never buy a subaru again. s'a rep

Complete Service Request Report



SUBARU®

Notes

Date Created 08/15/2008 16:57:19

Created By MCRE

Notes customer called : customer has taken the vehicle to the dealer for diagnosis . customer was advised faulty fuel Delivery hose . Advised will need to call dealer and research

Notes

Date Created 08/15/2008 16:56:58

Created By MCRE

Notes no open recalls /campaigns

22-Dec-2008 02:41:02

Page: 1

DEALER VEHICLE INQUIRY
 FOR DEALER: 550102 Needed for Claims passthrough - LMAT

 Vin 4S4-BT63C9 55108163
 Description (5PE C WHP) 2005 Baja 4EAT
 Option Description Pw/Pl/Pm/Ac/Cc/Abs,Alwhls/Ke/Dab/Fl/Mr,Ltr/Am/Fm/Cd/Bedcvr
 Model Ext/Int Spec Engine # Ign Key Trans #
 5PE WHP/GRA C 445544 31817 340045
 Dlr Demo Soa Demo Service Contract Case Ship Port
 SAS 020
 Production Date ETA Date Warranty Start Retail Date Retail Delivery
 14-Apr-2005 05-Jul-2005 12-Aug-2005 15-Aug-2005 12-Aug-2005

Salesman: ###-##-8683 Sales Order Type: Wholesale Sale Type: A

ALLOCATED:

SOLD BY:

 TURLOCK IMPORTS 140594 140594
 1901 AUTO MALL DR
 TURLOCK CA 95380

 TURLOCK IMPORTS 140594 140594
 1901 AUTO MALL DR
 TURLOCK CA 95380

PORT ACCESSORIES

PROMO CODE	ACCY CODE	ACCESSORY DESCRIPTION	DATE INSTALLED	ACCY TYPE
	K4E	AUTO-DIMMING MIRROR/COMPASS	23-Jun-2005	A
	Q5L	Splash guard kit, Silver	23-Jun-2005	A
	X43	ROADSIDE ASSISTANCE LABEL	23-Jun-2005	A
	XGE	BAJA FLOOR MATS	23-Jun-2005	A
	XGF	BAJA CROSS BARS	23-Jun-2005	A
	XJC	BAJA ORG	23-Jun-2005	A
	XJE	BAJA OIK	23-Jun-2005	A
	XJJ	05 BAJA SMOG LABEL	23-Jun-2005	A
	XJR	2005 BAJA OIK SUPPLEMENT	23-Jun-2005	A
L37	M3K	BED EXTENDER	23-Jun-2005	A
L37	M3L	CARGO NET BED	23-Jun-2005	A

OWNER:

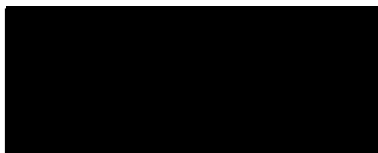

(W)
(F)

CO-OWNER:

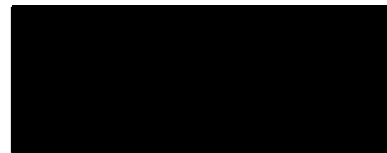

(W)
(F)

DRIVER:

(H)
(W)
(F)

CO-DRIVER:

(H)
(W)
(F)

12/22/2008 14:41:02

SUBARU STAR SYSTEM

PAGE: 1

Vehicle Coverage Inquiry
 FOR DEALER: 550102 Needed for Claims passthrough - LMAT

 VEHICLE DATA

VIN	MODEL YEAR	MODEL CODE	DESCRIPTION	OPTION CODE
4S4-BT63C9 55108163	2005.0	5PE	(5PE C WHP) 2005 Baja	4EAT TC

TRANS TYPE	SPEC CODE	DEMO IND	ALLOC DEALER	SELLING DEALER	WARR DATE	STR	OWNER
4EAT	C		140594	140594	12-Aug-2005	MS. JOANITA	[REDACTED]

 COVERAGE DETAIL

CLAIM TYPE	LABEL	EFFECTIVE DATE	EXPIRATION DATE	MILEAGE	EXTEN- SION	CONTROL NUMBER	R/C STATUS
WC	Fed Perform	08/12/05	08/12/07	24000	N		
		Federal Emissions Performance Warranty					
WC	Brake Pad	08/12/05	08/12/08	36000	N		
		Brake Pad Coverage					
WC	New Car Basc	08/12/05	08/12/08	36000	N		
		Basic New Car Warranty					
WC	New Car Adj	08/12/05	08/12/08	36000	N		
		New Car Adjustment Coverage					
WC	New Car Wear	08/12/05	08/12/08	36000	N		
		New Car Wear Item Warranty					
WC	Fed Defect	08/12/05	08/12/08	36000	N		
		Federal Emissions Defect Warranty					
WC	Cal Defect	08/12/05	08/12/08	50000	N		
		California Emissions Performance & Defect Warrant					
WC	Powertrain	08/12/05	08/12/10	60000	N		
		Powertrain Warranty					
WC	Cal Ext Deft	08/12/05	08/12/12	70000	N		
		California Emissions Extended Defect Warranty					
WC	Fed Ext Deft	08/12/05	08/12/13	80000	N		

12/22/2008 14:41:02

SUBARU STAR SYSTEM

PAGE: 2

Federal Emissions Extended Defect Warranty

WC Rust Perf 08/12/05 08/12/10 999999 N
 Rust Perforation Warranty

WC Life Seatblt 08/12/05 08/12/55 999999 N
 Lifetime Seatbelt Warranty

SA SAS Classic 08/12/05 08/12/11 80000 N
 SAS Classic Coverage

 EXTENSIONS

COVERAGE	REASON	ADDT'L MONTHS	ADDT'L MILES	EFFECTIVE DATE	EXPIRATION DATE	UPDATE DATE	USER
=====	=====	=====	=====	=====	=====	=====	=====
***** NO EXTENSIONS*****							

 EXCLUSIONS

EXCLUSION TYPE	EXCLUSION	EFFECTIVE DATE	EXPIRATION DATE	UPDATE DATE	USER
=====	=====	=====	=====	=====	=====
***** NO EXCLUSIONS*****					

 SAS CONTRACT

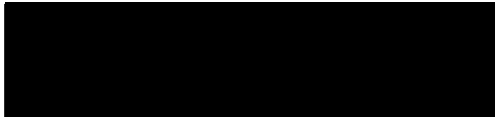
CONTRACT NUMBER	PLAN NUMBER	STATUS	DEDUCT-IBLE	START MILEAGE	CONTRACT OWNER
=====	=====	=====	=====	=====	=====
55115	103	Active	100.00	28	
Effective Date		08/12/05			
Transfer Date		Cancel Date			

 VEHICLE COMMENTS

***** NO COMMENTS*****

12/22/2008 14:41:02

SUBARU STAR SYSTEM

PAGE: 1

Vehicle Claim History Report

FOR DEALER: 550102 Needed for Claims passthrough - LMAT

VEHICLE DATA

VIN	MODEL YEAR	OPT CDE	MODEL CODE	DESCRIPTION	TRANS DEMO	TRIM TYPE	STYLE
4S4-BT63C9	55108163	2005.0	TC 5PE	(5PE C WHP) 2	4EAT	T	

ALLOC DEALER	SELLING DEALER	SALE DATE	WARRANTY START DATE	SPEC CODE	EXT/INT CLR/CLR
140594	140594	12-Aug-2005	12-Aug-2005	C	WHP/GRA

SAS CONTRACT INFORMATION

START DATE	EXPIRATION DATE	STATUS	OWNER
08/12/05	08/12/11	A	JOANITA

CLAIM DETAIL

SEQ NUM	CLAIM TYPE	RO / JOB	REGION DEALER	FAIL CODE	DAMAGE CODE	MILEAGE	ENTRY DATE
1	WC	254581	A 140-594	PAI47		28959	08/23/06
2	WC	254581	A 140-594	PAI47		28959	09/06/06

SEQ NUM	START DATE	COMPLETE DATE	ORIG CODE	PROC DATE	PROC CODE	AUTH CODE	TECHNICIAN ID
1	06/28/06	06/30/06	D	08/23/06	CDS		#####7013
2	06/28/06	06/30/06	D	09/06/06	CDS		#####7013

CLAIM CREDITS / DEBITS

SEQ NUM	CLAIM STATUS	POSTING DATE	TAX AMOUNT	SAS DEDUCT	PNT/MAT AMOUNT	TOWING AMOUNT	RENTAL AMOUNT
1	DB	08/25/06	0.00	0.00	0.00	0.00	0.00
		Debited					
2	CR	09/29/06	0.00	0.00	0.00	0.00	75.00
		Paid					

SEQ NUM	ORIGINAL CLAIM	ADJUST AMOUNT	NET CLAIM
---------	----------------	---------------	-----------

12/22/2008 14:41:02

SUBARU STAR SYSTEM

PAGE: 2

```

=== =====
1      202.16   -202.16    0.00
2      277.16    0.00    277.16
    
```

TOTAL CLAIMS FOR VEHICLE 55108163 277.16

LABOR INFORMATION

```

SEQ  LABOR  LABOR  ADDT'L  SUBLET  SUBLET  CLAIM
NUM  OPER #  HOURS  HOURS  HOURS  AMOUNT  LABOR
===  =====
1    612503  1.20   0.00   0.00   0.00   97.20
     ONE REAR STRUT OVERHAUL/R&R

2    612503  1.20   0.00   0.00   0.00   97.20
     ONE REAR STRUT OVERHAUL/R&R

TOTALS  2.40   0.00   0.00   0.00   194.40
    
```

PARTS INFORMATION

```

SEQ          UNIT  UNIT  EXTENDED  HANDL-  CLAIM  FAILED  RETURN
NUM  PART NUMBER  QTY  COST  COST  ING  PARTS  PART  CODE
===  =====
1    20310AE44A    1    74.97  74.97  29.99  104.96  Y
     STRUT COMPL F  RH
     TOTALS          74.97  29.99  104.96

2    20310AE44A    1    74.97  74.97  29.99  104.96  Y
     STRUT COMPL F  RH
     TOTALS          74.97  29.99  104.96
    
```

SEQ

NUM

CLAIM COMMENTS

```

=====
1  THE RIGHT FRONT STRUT IS LEAKING REMOVED AND REPLACED ALL OK
2  THE RIGHT FRONT STRUT IS LEAKING REMOVED AND REPLACED ALL OK
2  THE RIGHT FRONT STRUT IS LEAKING REMOVED AND REPLACED ALL OK
    
```

Subaru CIS - SieAppPrd1119 - Microsoft Internet Explorer provided by Subaru of America, Inc. XXX

File Edit View Favorites Tools Help

Address http://siebproapp.subaru1.com:8088/eaautomotive_enj/start.swe?SWECmd=Start&SWEHo=siebproapp.subaru1.com

Google Go Settings

File Edit View Navigate Query Tools Help

Home Accounts Contacts Dealers Vehicles **CDS Service Requests** Dealer Employees

Service Requests List

*Status: Closed	Joanita	Carline	Bojo	Region: #/Dealer: 140-768
Source: Phone	Preferred Name:	Year: 2005	Selling Dealer: Turbock-Subaru	Region: #/Dealer: 140-594
Alert:	Preferred Contact Method:	SR Mileage: 58151	Region: #/Dealer: 140-594	Dealer: []
OOB:	Preferred Contact Type:	VIN Mileage:	Vehicle Relationship:	Family Fuel Delivery Issue
OOB Date:	Customer Email:		Primary Contact: N/A	
SR Owner: MORE	Second Contact Last Name:		Second Contact: N/A	
Last Modified By: CBAL	Second Contact First Name:		Change Relationship	
Last Modified Date: 8/15/2008 10:53:01	Preferred Contact Method:			
Closed By: CBAL	Preferred Contact Type:			
SR Creator: MORE	Business Account:			
Created Date: 8/15/2008 04:53:57	Business Contact Last Name:			
	Business Contact First Name:			

Activities Attachments SR Issues Charges Audit Trail Notes Letters Solutions Owner Transaction Email

Menu Query New File New URL

Attachment Name Type

> 2be45161-2b8b-430c-a7.pdf
9a2eab32-0e54-421e-b6.pdf

Created By: 9/15/2008 04:09:59 P. SADMIN
Created Date: 8/29/2008 08:34:41 SADMIN

1 - 2 of 2

start

2 Internet Explorer 3 Microsoft Office 3:55 PM

PAGES
4

Fax

ATT: Marisol

From: Juanita 

Date: 08/28/08

1-75186548

08/28/08

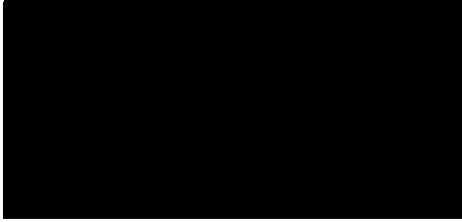

To: Subaru Customer Service:

We brought our car in October 2006 in Turlock, CA. We looked for a while but I new I wanted a Baja I have always liked the look. So my husband took me down to test drive the Turbo and of course I loved it. We bought it brand new only had 18 miles on her. The reason for this letter is my dream car was a bomb waiting to happen to me. In August I started smelling gas, I took the car to my mechanic, he looked under and could see I had been leaking but could not find it at the time. Told me to bring it back the next day and he would put it on the rack. So I did, I left for about 10 minutes when I got a call on my cell requesting me to come back. When I did he showed me where the leak was and told me I could no longer drive my car anywhere. There was a crack in the plastic where the assembly on top of the gas tank right were the electrical wires are. This is in my back sit. Do you know I have had many people in my car and I could of blown them and me up. A cigarette could of set me off. I paid this car off in 8 months. I have looked to see if there were any others that had this same problem. I towed the car to the nearest Subaru dealer to fix. Here is

the bill I paid. They were even afraid to move the car and fixed right where it was. I hope your company will do the right thing and take care of this bill. I would hate to not buy another Subaru because of this. Please help!

Sincerely,

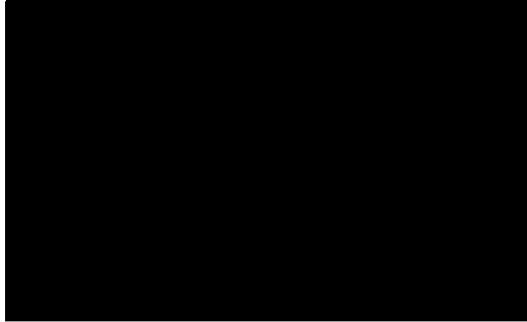



SONORA SUBARU

SERVICING ALL MAKES AND MODELS IN THE MOTHERLODE

209-532-5926 14890 Mono Way, Sonora, CA 95370 209-533-8777

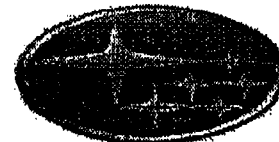

SUBARU

VIN 00852 4 S 4 B T 6 3 C 9 5 5				DATE IN 08/13/08
YEAR 2005	MAKE SUBARU	MODEL BAJA TURBO	COLOR	TIME 02:40
MILES IN 99111	MILES OUT 99111	IN SERVICE DATE 00/00/00	USD 7X49915	CLOCKS 08/19/08
SEE ALSO				WRITER 3545 ANDY

(1) CHECK & ADVISE ON FUEL SMELL
 TECH FOUND PLASTIC CRACKED @ FUEL OUTLET @ PUMP HOUSING, THIS IS CAUSING FUEL TO PUMP OUT & GATHER @ ELECTRICAL LEADS. TECH REPLACED FAILED FUEL PUMP ASSY. COMPLETE

Labor	T04	95.00
42021AE08A (PUMP ASSY FUEL)	1	425.87
FREIGHT	00852	53.66
Total Labor		95.00
Total Parts		425.87
Total Sublet		53.66
Total Repair (Customer)		574.53

(Tech:04) A

Cost Dealer Services
 1- 800-Subaru3

(Cherry Hill New Jersey)

ORIGINAL ESTIMATE \$ _____	AUTHORIZED ADDITIONS \$ _____ X _____ Customer Acceptance	BAR#AC247838 EPA#CALD00310815
X _____ Customer Acceptance	Date _____ Time _____ By _____	X _____ CUSTOMER'S SIGNATURE

Next Service DEC '08 Lube-Oil-Filter	TERMS No returns on electrical or special order items. A restocking charge will be applied on all merchandise returned for credit or refund. No returns after 30 days.	W/C .00 .00 .00 .00 .00 .00 .00	INT .00	CUSTOMER Labor 95.00 Parts 425.87 Sublet 53.66 Waste Dispos .00 Oil/Grease .00 Sub Total 574.53 Tax 30.98 Total (Cash) 605.41
<p>DISCLAIMER OF WARRANTIES Any warranties on the product sold hereby are those made by the manufacturer. The seller hereby expressly disclaims all warranties either expressed or implied, including any implied warranty of merchantability of fitness for a particular purpose, and neither assumes nor authorizes any person to assume for it any liability in connection with the sale of said products. Any limitation contained herein does not apply where prohibited by law.</p>		<p>Page 1 of 1 Job 00852 00852 Customer Copy</p>		
-26 ⁰⁵ 579.36				

Issues

Reason	Type	Area	Sub-Area	Status	Dealer Name	Region # Dealer #	Created By	Date Created	Last Modified By	Last Modified Date
Complaint/Negative	Vehicle	Fuel System	General	Closed	Sonora Subaru	140-768	MCRE	8/15/2008 04:56:25 PM	MCRE	8/15/2008 05:01:17 PM

Issues

Reason	Type	Area	Sub-Area	Status	Dealer Name	Region #/ Dealer #	Created By	Date Created	Last Modified By	Last Modified Date
Complaint/Negative	Vehicle	Fuel System	General	Closed	Sonora Subaru	140-768	MCRE	8/15/2008 04:56:25 PM	MCRE	8/15/2008 05:01:17 PM

Audit Trail Items

Business Component	Child Business Component	Field	Old Value	New Value	Operation	Date	Employee Login	Record ID
Service Request		Status	Open	Closed	Modify	9/16/2008 10:53:01 AM	CBAL	1-18RIB8
SOA_CDS_Service Request Notes		Note		customer called. transfered to rep	Modify	9/16/2008 10:52:52 AM	CBAL	1-1KHBTI
SOA_CDS_Service Request Notes		Id		1-1KHBTI	New Record	9/16/2008 10:52:18 AM	CBAL	1-1KHBTI
Service Request		Status	Closed	Open	Modify	9/16/2008 10:51:37 AM	CBAL	1-18RIB8
Service Request		Status	Open	Closed	Modify	9/16/2008 10:34:09 AM	MCRE	1-18RIB8
SOA_CDS_Service Request Notes		Note		customer called : advised can not offer any GW assitance at this time due to the mileage on the vehicle . Customer stated she will never buy another subaru . Apologized to the customer	Modify	9/16/2008 10:34:05 AM	MCRE	1-1KH93Q
SOA_CDS_Service Request Notes		Id		1-1KH93Q	New Record	9/16/2008 10:31:58 AM	MCRE	1-1KH93Q
SOA_CDS_Service Request Notes		Note	reviewed with TI - not offering aany GW assitance at this time	reviewed with TI - not offering any GW assitance at this time	Modify	9/16/2008 10:29:42 AM	MCRE	1-1KCDJD
SOA_CDS_Service Request Notes		Note		called customer : left message on voicemail	Modify	9/15/2008 04:17:55 PM	MCRE	1-1KCDO7
SOA_CDS_Service Request Notes		Id		1-1KCDO7	New Record	9/15/2008 04:17:17 PM	MCRE	1-1KCDO7
SOA_CDS_Service Request Notes		Note	reviewed with TI - not offer	reviewed with TI - not offering aany GW assitance at this time	Modify	9/15/2008 04:12:42 PM	MCRE	1-1KCDJD
SOA_CDS_Service Request Notes		Note		reviewed with TI - not offer	Modify	9/15/2008 03:46:50 PM	MCRE	1-1KCDJD
SOA_CDS_Service Request Notes		Id		1-1KCDJD	New Record	9/15/2008 03:45:39 PM	MCRE	1-1KCDJD
SOA_CDS_Service Request Notes		Note		called dealer : spoke with SM states tech lifted the back seat and noticed a crack in the plastic housing of the fuel delivery house which caused the fuel to pump out near the electrical wiring . Sm states he has never seen anything this bad	Modify	9/15/2008 02:38:37 PM	MCRE	1-1KBOU0

Business Component	Child Business Component	Field	Old Value	New Value	Operation	Date	Employee Login	Record ID
				before				
SOA_CDS_Service Request Notes		Id		1-1KBOU0	New Record	9/15/2008 02:36:52 PM	MCRE	1-1KBOU0
SOA_CDS_Service Request Notes		Note		called dealer ; left message for SM andy requesting a callback .	Modify	8/29/2008 03:07:50 PM	MCRE	1-1HMUE7
SOA_CDS_Service Request Notes		Id		1-1HMUE7	New Record	8/29/2008 03:07:31 PM	MCRE	1-1HMUE7
SOA_CDS_Service Request Notes		Note	customer called : customer has taken the vehicle to the dealer for diagnosis . customer was advised faulty fuel Delivery hose .	customer called : customer has taken the vehicle to the dealer for diagnosis . customer was advised faulty fuel Delivery hose . Advised will need to call dealer and research	Modify	8/29/2008 03:05:29 PM	MCRE	1-18SIYA
SOA_CDS_Service Request Notes		Note	cust called, dir inspected and directed cust to send in ro bc they feel issue is defect. cust will fax to 3016, cust feels vehicle was a bomb very damagerous to drive and is requesting assistance otherwise she will never buy a subaru again.	cust called, dir inspected and directed cust to send in ro bc they feel issue is defect. cust will fax to 3016, cust feels vehicle was a bomb very dangerous to drive and is requesting assistance otherwise she will never buy a subaru again. s'a rep	Modify	8/27/2008 10:32:00 AM	KMIL	1-1H1IVZ
SOA_CDS_Service Request Notes		Note	cust	cust called, dir inspected and directed cust to send in ro bc they feel issue is defect. cust will fax to 3016, cust feels vehicle was a bomb very damagerous to drive and is requesting assistance otherwise she will never buy a subaru again.	Modify	8/27/2008 10:31:39 AM	KMIL	1-1H1IVZ
SOA_CDS_Service Request Notes		Note		cust	Modify	8/27/2008 10:29:20 AM	KMIL	1-1H1IVZ
SOA_CDS_Service Request Notes		Id		1-1H1IVZ	New Record	8/27/2008 10:28:00 AM	KMIL	1-1H1IVZ

Business Component	Child Business Component	Field	Old Value	New Value	Operation	Date	Employee Login	Record Id
Service Request		Status	Closed	Open	Modify	8/27/2008 10:27:54 AM	KMIL	1-18RIB8
Service Request		Status	Open	Closed	Modify	8/15/2008 05:01:20 PM	MCRE	1-18RIB8
SOA_CDS_Service Request Notes		Note		customer called : customer has taken the vehicle to the dealer for diagnosis . customer was advised faulty fuel Delivery hose .	Modify	8/15/2008 05:01:09 PM	MCRE	1-18SIYA
SOA_CDS_Service Request Notes		Note		no open recalls /campaigns	Modify	8/15/2008 04:57:19 PM	MCRE	1-18SIVY
SOA_CDS_Service Request Notes		Id		1-18SIYA	New Record	8/15/2008 04:57:19 PM	MCRE	1-18SIYA
SOA_CDS_Service Request Notes		Id		1-18SIVY	New Record	8/15/2008 04:56:58 PM	MCRE	1-18SIVY
Service Request		SOA Pref Con Type		2097288561	Modify	8/15/2008 04:56:25 PM	MCRE	1-18RIB8
Service Request		Description	F	Faulty Fuel Delivery hose	Modify	8/15/2008 04:56:12 PM	MCRE	1-18RIB8
Service Request		Description		F	Modify	8/15/2008 04:55:21 PM	MCRE	1-18RIB8
Service Request		Id		1-18RIB8	New Record	8/15/2008 04:53:56 PM	MCRE	1-18RIB8

Notes

Date Created	Created By	Note
9/16/2008 10:52:18 AM	CBAL	customer called. transferred to rep
9/16/2008 10:31:58 AM	MCRE	customer called : advised can not offer any GW assistance at this time due to the mileage on the vehicle . Customer stated she will never buy another subaru . Apologized to the customer
9/15/2008 04:17:17 PM	MCRE	called customer : left message on voicemail
9/15/2008 03:45:39 PM	MCRE	reviewed with TI - not offering any GW assistance at this time
9/15/2008 02:36:52 PM	MCRE	called dealer : spoke with SM states tech lifted the back seat and noticed a crack in the plastic housing of the fuel delivery house which caused the fuel to pump out near the electrical wiring . Sm states he has never seen anything this bad before
8/29/2008 03:07:31 PM	MCRE	called dealer : left message for SM andy requesting a callback .
8/27/2008 10:28:00 AM	KMIL	cust called, dir inspected and directed cust to send in ro bc they feel issue is defect. cust will fax to 3016, cust feels vehicle was a bomb very dangerous to drive and is requesting assistance otherwise she will never buy a subaru again. s'a rep
8/15/2008 04:57:19 PM	MCRE	customer called : customer has taken the vehicle to the dealer for diagnosis . customer was advised faulty fuel Delivery hose . Advised will need to call dealer and research
8/15/2008 04:56:58 PM	MCRE	no open recalls /campaigns

Quality Monitoring Report

View Reports

QMR ID	Created By	Report Date	Last Update Date	Region	Dealer
32249	040985	10/16/2007	10/16/2007	040	985

Section
Fuel and Emissions

Sub Section
Fuel Tank, Pump and Sending Units

VIN
65 [REDACTED]

Engine #
688285

Trans. #
[REDACTED]

Mileage
51526

Failure Code
DBA37

Failure Date
09/26/2007

Technician Duplicated Condition
Yes

Failed Part #
42021AE08A

R/O Number
40755

Rollover **Fire Request Authorization**
No No No

Reporter Name
Bob Carver

Reporter's Email
bcarver@subaruofdallas.com

Customer's Description of Complaint

customer states strong smell from right rear after driving for a while

Technician's Findings and Repair

found return fitting on fuel pump housing cracked leaking fuel. replaced fule pump and replaced underseat matting that was fuel soaked and cleaned from from interior and air dried.

Vehicle Speed MPH	Ambient Temp. °F	# of Passengers	Total lbs.
Altitude Ft.	% Humidity	Cold Soak Hrs Min	Hot Soak Hrs Min

Weather Conditions

Type of Road

Attachments
(None)

VIN Remainder 4S4 [REDACTED]	Warranty Start Date 05/26/2006	Production Date 01/27/2006	Car Line BAJA
Original Engine # 688285	Trans. Type Desc. 4-Speed Automatic	Model Year 2006	Model Code 6PE
Color BLK	Option Pkg. TC	Emissions Spec. C	Turbo? Yes
Engine Size 2.5			

Print QMR

Back To Search

Agreements

Contract Owner	Contract #	Coverage Type	Plan Description	Status	Contract Start Date	Contract Expiration	Contract Termination Date
Stephen Tinkle	H203920	New Classic	4yr/60,000 \$100 Deductible	Expired	7/30/2003 12:00:00 AM	7/30/2007 12:00:00 AM	

Personal Addresses

Primary	Address	Address 2	City	State	Zip	Country	Type	Start Date	End Date
✓	3615 Amherst Ave		Dallas	TX	75225-7422	USA	Home		

22-Dec-2008 02:22:59

Page: 1

DEALER VEHICLE INQUIRY
 FOR DEALER: 550102 Needed for Claims passthrough - LMAT

 Vin 4S4-BT63C3 65 [REDACTED]
 Description (6PE C BLK) 2006 Baja 4EAT
 Option Description Pw/Pl/Pm/Ac/Cc/Abs,Alwhls/Ke/Dab/Fl/Mr,Ltr/Am/Fm/Cd/Bedcvr
 Model Ext/Int Spec Engine # Ign Key Trans #
 6PE BLK/GRA C 688285 30821 537204
 Dlr Demo Soa Demo Service Contract Case Ship Port
 NONE 020
 Production Date ETA Date Warranty Start Retail Date Retail Delivery
 27-Jan-2006 22-Feb-2006 26-May-2006 29-May-2006 26-May-2006

Salesman: ###-##-9543 Sales Order Type: Wholesale Sale Type: L

ALLOCATED: SOLD BY:

 SUBARU OF DALLAS 040985 040985 SUBARU OF DALLAS 040985 040985
 5403 LEMMON AVENUE 5403 LEMMON AVENUE
 DALLAS TX 75209 DALLAS TX 75209

PORT ACCESSORIES

PROMO CODE	ACCY CODE	ACCESSORY DESCRIPTION	DATE INSTALLED	ACCY TYPE
	K5G	Auto Dim Mirror/Compass Homelink	06-Feb-2006	A
	XAA	PDI	06-Feb-2006	A
	XDN	INDEPENDENT HANDLING	06-Feb-2006	A
X76	X43	ROADSIDE ASSISTANCE LABEL	06-Feb-2006	A
X76	XGE	BAJA FLOOR MATS	06-Feb-2006	A
X76	XGF	BAJA CROSS BARS	06-Feb-2006	A
X76	XKA	2006 BAJA ORG	06-Feb-2006	A
X76	XKF	2006 BAJA OIK	06-Feb-2006	A

OWNER: [REDACTED] CO-OWNER:

 (H)
 (W)
 (F)

DRIVER: CO-DRIVER:

 (H)
 (W)
 (F)

12/22/2008 14:22:59

SUBARU STAR SYSTEM

PAGE: 1

Vehicle Coverage Inquiry

FOR DEALER: 550102 Needed for Claims passthrough - LMAT

VEHICLE DATA

VIN	MODEL YEAR	MODEL CODE	DESCRIPTION	OPTION CODE
4S4-BT63C3 65103249	2006.0	6PE	(6PE C BLK) 2006 Baja	4EAT TC

TRANS TYPE	SPEC CODE	DEMO IND	ALLOC DEALER	SELLING DEALER	WARR DATE	STR	OWNER
4EAT	C		040985	040985	26-May-2006	MR. STEPHEN	[REDACTED]

COVERAGE DETAIL

CLAIM TYPE	LABEL	EFFECTIVE DATE	EXPIRATION DATE	MILEAGE	EXTEN- SION	CONTROL NUMBER	R/C STATUS
WC	Fed Perform	05/26/06	05/26/08	24000	N		
Federal Emissions Performance Warranty							
WC	Brake Pad	05/26/06	05/26/09	36000	N		
Brake Pad Coverage							
WC	New Car Basc	05/26/06	05/26/09	36000	N		
Basic New Car Warranty							
WC	New Car Adj	05/26/06	05/26/09	36000	N		
New Car Adjustment Coverage							
WC	New Car Wear	05/26/06	05/26/09	36000	N		
New Car Wear Item Warranty							
WC	Fed Defect	05/26/06	05/26/09	36000	N		
Federal Emissions Defect Warranty							
WC	Cal Defect	05/26/06	05/26/09	50000	N		
California Emissions Performance & Defect Warrant							
WC	Powertrain	05/26/06	05/26/11	60000	N		
Powertrain Warranty							
WC	Cal Ext Deft	05/26/06	05/26/13	70000	N		
California Emissions Extended Defect Warranty							
WC	Fed Ext Deft	05/26/06	05/26/14	80000	N		

12/22/2008 14:22:59

SUBARU STAR SYSTEM

PAGE: 2

Federal Emissions Extended Defect Warranty

WC Rust Perf 05/26/06 05/26/11 999999 N
Rust Perforation Warranty

WC Life Seatblt 05/26/06 05/26/56 999999 N
Lifetime Seatbelt Warranty

EXTENSIONS

COVERAGE	REASON	ADDT'L MONTHS	ADDT'L MILES	EFFECTIVE DATE	EXPIRATION DATE	UPDATE DATE	USER
=====	=====	=====	=====	=====	=====	=====	=====
***** NO EXTENSIONS*****							

EXCLUSIONS

EXCLUSION TYPE	EXCLUSION	EFFECTIVE DATE	EXPIRATION DATE	UPDATE DATE	USER
=====	=====	=====	=====	=====	=====
***** NO EXCLUSIONS*****					

SAS CONTRACT

CONTRACT NUMBER	PLAN NUMBER	DEDUCT- STATUS	IBLE	START MILEAGE	CONTRACT OWNER
=====	=====	=====	=====	=====	=====
***** NO SAS CONTRACT*****					

VEHICLE COMMENTS

***** NO COMMENTS*****

12/22/2008 14:22:59

SUBARU STAR SYSTEM

PAGE: 1

Vehicle Claim History Report

FOR DEALER: 550102 Needed for Claims passthrough - LMAT

VEHICLE DATA

VIN	MODEL YEAR	OPT CDE	MODEL CODE	DESCRIPTION	TRANS DEMO	TRIM TYPE	STYLE
4S4-BT63C3	65103249	2006.0	TC 6PE	(6PE C BLK) 2	4EAT	T	

ALLOC DEALER	SELLING DEALER	SALE DATE	WARRANTY START DATE	SPEC CODE	EXT/INT CLR/CLR
040985	040985	26-May-2006	26-May-2006	C	BLK/GRA

SAS CONTRACT INFORMATION

START DATE EXPIRATION DATE STATUS OWNER

***** No SAS Contract Information *****

CLAIM DETAIL

SEQ NUM	CLAIM TYPE	RO / JOB	REGION DEALER	FAIL CODE	DAMAGE CODE	MILEAGE	ENTRY DATE
1	WC	34374	A 040-985	XDM04		17970	10/12/06
2	PA	40755	A 040-985	DBA37		51526	10/02/07

SEQ NUM	START DATE	COMPLETE DATE	ORIG CODE	PROC DATE	PROC CODE	AUTH CODE	TECHNICIAN ID
1	10/10/06	10/11/06	D	10/12/06	CDS		#####0162
2	09/26/07	10/02/07	D	10/04/07	USER		#####5120

CLAIM CREDITS / DEBITS

SEQ NUM	CLAIM STATUS	POSTING DATE	TAX AMOUNT	SAS DEDUCT	PNT/MAT AMOUNT	TOWING AMOUNT	RENTAL AMOUNT
1	CR	10/27/06	0.00	0.00	0.00	0.00	0.00
		Paid					
2	CR	10/26/07	0.00	0.00	0.00	0.00	0.00
		Paid					

SEQ NUM	ORIGINAL CLAIM	ADJUST AMOUNT	NET CLAIM
---------	----------------	---------------	-----------

12/22/2008 14:22:59

SUBARU STAR SYSTEM

PAGE: 2

```

=== =====
1      79.20      0.00      79.20
2      545.21      0.00      545.21
    
```

TOTAL CLAIMS FOR VEHICLE 65103249 624.41

 LABOR INFORMATION

SEQ NUM	LABOR OPER #	LABOR HOURS	ADDT'L HOURS	SUBLET HOURS	SUBLET AMOUNT	CLAIM LABOR
===	=====	=====	=====	=====	=====	=====
1	914001	0.50	0.00	0.00	0.00	44.00
	SUNROOF WATER or AIR LEAK TESTING & DIAGNOSIS					
1	914908	0.40	0.00	0.00	0.00	35.20
	SUNROOF ADJUST					
2	471001	0.50	0.00	0.00	0.00	45.00
	FUEL PUMP R&R					
2	475001	0.50	0.00	0.00	0.00	45.00
	FUEL SYSTEM - TESTING					
2	913324	0.80	0.00	0.00	0.00	72.00
	INTERIOR CARPET R&R					
	TOTALS	2.70	0.00	0.00	0.00	241.20

 PARTS INFORMATION

SEQ NUM	PART NUMBER	UNIT QTY	UNIT COST	EXTENDED COST	HANDL- ING	CLAIM PARTS	FAILED PART	RETURN CODE
===	=====	===	=====	=====	=====	=====	=====	=====
1	No Parts Data							
2	42021AE08A	1	279.95	279.95	0.00	279.95	Y	A50
	PUMP ASSY FUEL							
2	42037AE110	1	5.08	5.08	0.00	5.08	N	
	CLAMP RETAINER							
2	95070AE13A	1	98.18	98.18	0.00	98.18	N	
	COVER R FLOOR							
	TOTALS			383.21	0.00	383.21		

 SEQ
 NUM CLAIM COMMENTS

```

=====
1  CUSTOMER STATES WATER LEAKING IN AROUND SUN ROOF COMING OUT AROUND UPP
    
```

12/22/2008 14:22:59

SUBARU STAR SYSTEM

PAGE: 3

ER CONSOLE WATER TEST SUNROOF. EXCESSIVE WATER BYPASS AT RIGHT REAR OF
SUNROOF GLASS OVERRUNNING DRAIN CHANNELS. SUNROOF GLASS MIADJSUTED TO
LEFT SIDE ADJ USTED SUNROOF GLASS AND R
ETEST WITH WATER

- 2 customer states strong fuel smell from right rear after driving for a
while fitting on fuel pump housing cracked and leaking fuel. also carp
et mat so aked replaced fuel pump, underseat mat. cleaned fuel from in
terior and air dried

Quality Monitoring Report

View Reports

QMR ID	Created By	Report Date	Last Update Date	Region	Dealer
32342	040985	10/18/2007	10/18/2007	040	985

Section
Fuel and Emissions

Sub Section
Fuel Delivery and Evaporative System

VIN
6S [REDACTED]

Engine #
456367

Trans. #

Mileage
46493

Failure Code
DBA37

Failure Date
10/11/2007

Technician Duplicated Condition
Yes

Failed Part #
42021AE08A

R/O Number
40949

Rollover **Fire** **Request Authorization**
No No No

Reporter Name
Bob Carver

Reporter's Email
bcarver@subaruofdallas.com

Customer's Description of Complaint
customer states that there is a fuel smell.

Technician's Findings and Repair
fuel tank pump leaking at return line elbow. elbow snapped off. replaced fuel pump and pressure tested system for other leaks. no leaks found at this time

Vehicle Speed MPH	Ambient Temp. °F	# of Passengers	Total lbs.
Altitude Ft.	% Humidity	Cold Soak Hrs Min	Hot Soak Hrs Min

Weather Conditions

Type of Road

Attachments
(None)

VIN Remainder 4S [REDACTED]	Warranty Start Date 11/18/2005	Production Date 05/12/2005	Car Line BAJA
Original Engine # 456367	Trans. Type Desc. 4-Speed Automatic	Model Year 2006	Model Code 6PE
Color SIV	Option Pkg. TC	Emissions Spec. C	Turbo? Yes
Engine Size 2.5			

Print QMR

Back To Search

Agreements

Contract Owner	Contract #	Coverage Type	Plan Description	Status	Contract Start Date	Contract Expiration	Contract Termination Date
Si Song	76212	New Gold Plus	5yr/100,000 \$0 Deductible	Active	11/18/2005 12:00:00 AM	11/18/2010 12:00:00 AM	

Contacts

Primary	Last Name	First Name	Address	City	State	Zip	Relationship	Updated Date
✓	Song	Si	4304 Castle Rock Ct	Irving	TX	75038-6438	Owner	11/21/2005 10:17:58 PM

22-Dec-2008 04:12:12

Page: 1

DEALER VEHICLE INQUIRY
 FOR DEALER: 550102 Needed for Claims passthrough - LMAT

 Vin 4S4-BT63C2 65 [REDACTED]
 Description (6PE C SIV) 2006 Baja 4EAT
 Option Description Pw/Pl/Pm/Ac/Cc/Abs,Alwhls/Ke/Dab/Fl/Mr,Ltr/Am/Fm/Cd/Bedcvr
 Model Ext/Int Spec Engine # Ign Key Trans #
 6PE SIV/GRA C 456367 30647 349438
 Dlr Demo Soa Demo Service Contract Case Ship Port
 SAS 020
 Production Date ETA Date Warranty Start Retail Date Retail Delivery
 12-May-2005 23-Sep-2005 18-Nov-2005 21-Nov-2005 18-Nov-2005

Salesman: ###-##-7894 Sales Order Type: Wholesale Sale Type: L

ALLOCATED:

SOLD BY:

TEAPE SUBARU OF ARLINGTON 040988
 1333 E I 20

SUBARU OF DALLAS 040985 040985
 5403 LEMMON AVENUE

ARLINGTON TX 76018

DALLAS TX 75209

PORT ACCESSORIES

PROMO CODE	ACCY CODE	ACCESSORY DESCRIPTION	DATE INSTALLED	ACCY TYPE
	X43	ROADSIDE ASSISTANCE LABEL	12-Sep-2005	P
	XAA	PDI	12-Sep-2005	A
	XDN	INDEPENDENT HANDLING	12-Sep-2005	A
	XGE	BAJA FLOOR MATS	12-Sep-2005	P
	XGF	BAJA CROSS BARS	12-Sep-2005	P
	XKF	2006 BAJA OIK	12-Sep-2005	P
L6L	K5G	Auto Dim Mirror/Compass Homelink	12-Sep-2005	A
L6L	M3H	CARGO NET VERTICAL	12-Sep-2005	A
L6L	M3I	CARGO NET HORIZONTAL	12-Sep-2005	A
L6L	R6L	Security Shock Sensor	12-Sep-2005	A

OWNER:



(F)

CO-OWNER:

(H)

(W)

(F)

DRIVER:

(H)

(W)

(F)

CO-DRIVER:

(H)

(W)

(F)

12/22/2008 16:12:12

SUBARU STAR SYSTEM

PAGE: 1

Vehicle Coverage Inquiry

FOR DEALER: 550102 Needed for Claims passthrough - LMAT

VEHICLE DATA

VIN	MODEL YEAR	MODEL CODE	DESCRIPTION	OPTION CODE
4S4-BT63C2 65100097	2006.0	6PE	(6PE C SIV) 2006 Baja	4EAT TC

TRANS TYPE	SPEC CODE	DEMO IND	ALLOC DEALER	SELLING DEALER	WARR DATE	STR	OWNER
4EAT	C		040988	040985	18-Nov-2005		MR. SI H SONG

COVERAGE DETAIL

CLAIM TYPE	LABEL	EFFECTIVE DATE	EXPIRATION DATE	MILEAGE	EXTEN- SION	CONTROL NUMBER	R/C STATUS
WC	Fed Perform	11/18/05	11/18/07	24000	N		
		Federal Emissions Performance Warranty					
WC	Brake Pad	11/18/05	11/18/08	36000	N		
		Brake Pad Coverage					
WC	New Car Basc	11/18/05	11/18/08	36000	N		
		Basic New Car Warranty					
WC	New Car Adj	11/18/05	11/18/08	36000	N		
		New Car Adjustment Coverage					
WC	New Car Wear	11/18/05	11/18/08	36000	N		
		New Car Wear Item Warranty					
WC	Fed Defect	11/18/05	11/18/08	36000	N		
		Federal Emissions Defect Warranty					
WC	Cal Defect	11/18/05	11/18/08	50000	N		
		California Emissions Performance & Defect Warrant					
WC	Powertrain	11/18/05	11/18/10	60000	N		
		Powertrain Warranty					
WC	Cal Ext Deft	11/18/05	11/18/12	70000	N		
		California Emissions Extended Defect Warranty					
WC	Fed Ext Deft	11/18/05	11/18/13	80000	N		

12/22/2008 16:12:12

SUBARU STAR SYSTEM

PAGE: 2

Federal Emissions Extended Defect Warranty

WC Rust Perf 11/18/05 11/18/10 999999 N
 Rust Perforation Warranty

WC Life Seatblt 11/18/05 11/18/55 999999 N
 Lifetime Seatbelt Warranty

SA SAS Gold 11/18/05 11/18/10 100000 N
 SAS Gold Coverage

 EXTENSIONS

COVERAGE	REASON	ADDT'L MONTHS	ADDT'L MILES	EFFECTIVE DATE	EXPIRATION DATE	UPDATE DATE	USER
***** NO EXTENSIONS*****							

 EXCLUSIONS

EXCLUSION TYPE	EXCLUSION	EFFECTIVE DATE	EXPIRATION DATE	UPDATE DATE	USER
***** NO EXCLUSIONS*****					

 SAS CONTRACT

CONTRACT NUMBER	PLAN NUMBER	STATUS	DEDUCT-IBLE	START MILEAGE	CONTRACT OWNER
76212	508	Active	0.00	65	
Effective Date		11/18/05			
Transfer Date		Cancel Date			

 VEHICLE COMMENTS

***** NO COMMENTS*****

12/22/2008 16:12:12

SUBARU STAR SYSTEM

PAGE: 1

Vehicle Claim History Report

FOR DEALER: 550102 Needed for Claims passthrough - LMAT

VEHICLE DATA

VIN	MODEL YEAR	OPT CDE	MODEL CODE	DESCRIPTION	DEMO	TRANS TYPE	TRIM STYLE
4S4-BT63C2 65 [REDACTED]	2006.0	TC	6PE	(6PE C SIV) 2		4EAT	T

ALLOC DEALER	SELLING DEALER	SALE DATE	WARRANTY START DATE	SPEC CODE	EXT/INT CLR/CLR
040988	040985	18-Nov-2005	18-Nov-2005	C	SIV/GRA

SAS CONTRACT INFORMATION

START DATE	EXPIRATION DATE	STATUS	OWNER
11/18/05	11/18/10	A	[REDACTED] SI H

CLAIM DETAIL

SEQ NUM	CLAIM TYPE	RO / JOB	REGION DEALER	FAIL CODE	DAMAGE CODE	MILEAGE	ENTRY DATE
1	SA	40949	A 040-985	DBA37		46493	10/19/07

SEQ NUM	START DATE	COMPLETE DATE	ORIG CODE	PROC DATE	PROC CODE	AUTH CODE	TECHNICIAN ID
1	10/11/07	10/16/07	D	10/19/07	CDS		#####2699

CLAIM CREDITS / DEBITS

SEQ NUM	CLAIM STATUS	POSTING DATE	TAX AMOUNT	SAS DEDUCT	PNT/MAT AMOUNT	TOWING AMOUNT	RENTAL AMOUNT
1	CR	10/26/07	23.10	0.00	0.00	0.00	0.00

Paid

SEQ NUM	ORIGINAL CLAIM	ADJUST AMOUNT	NET CLAIM
1	421.80	0.00	421.80

TOTAL CLAIMS FOR VEHICLE 65100097 421.80

12/22/2008 16:12:12

SUBARU STAR SYSTEM

PAGE: 2

LABOR INFORMATION

SEQ NUM	LABOR OPER #	LABOR HOURS	ADDT'L HOURS	SUBLET HOURS	SUBLET AMOUNT	CLAIM LABOR
===	=====	=====	=====	=====	=====	=====
1	471001	0.50	0.00	0.00	0.00	59.38
	FUEL PUMP R&R					
1	475001	0.50	0.00	0.00	0.00	59.38
	FUEL SYSTEM - TESTING					
TOTALS		1.00	0.00	0.00	0.00	118.76

PARTS INFORMATION

SEQ NUM	PART NUMBER	UNIT QTY	UNIT COST	EXTENDED COST	HANDL- ING	CLAIM PARTS	FAILED PART	RETURN CODE
===	=====	===	=====	=====	=====	=====	=====	=====
1	42021AE08A	1	279.95	279.95	0.00	279.95	Y	A50
	PUMP ASSY FUEL							
TOTALS				279.95	0.00	279.95		

SEQ

NUM

CLAIM COMMENTS

=====
 1 CUSTOMER STATES THERE IS A FUEL SMELL FUEL TANK PUMP LEAKING AT RETURN
 LINE ELBOW. WHEN REMOVONG LINE ELBOW SNAPPED OFF REPLACED FUEL PUMP
 AND PRESS URE TESTED SYSTEM FOR LEAKS. NO FURTHER LEAKS

Quality Monitoring Report

[View Reports](#)

QMR ID 32396	Created By wdav	Report Date 10/22/2007	Last Update Date 10/22/2007	Region 040	Dealer 985
------------------------	---------------------------	----------------------------------	---------------------------------------	----------------------	----------------------

Section
Fuel and Emissions

Sub Section
Fuel Delivery and Evaporative System

VIN
5S [REDACTED]

Engine #

Trans. #

Mileage
31351

Failure Code
DBA37

Failure Date
08/28/2007

Technician Duplicated Condition
Yes

Failed Part #

R/O Number
40282

Rollover **Fire Request Authorization**
No No No

Reporter Name
William Davis

Reporter's Email
wdavis@subaru.com

Customer's Description of Complaint

Customer states smells fuel inside of car.

Technician's Findings and Repair

Inspected vehicle and found fuel nipple broken off of fuel pump. Vehicle had no signs of damage and protective cover was around the fuel pump with no signs of damage. Cause of failure did not appear to be from outside influences. Dealer replaced pump and replaced gasoline damaged parts.

Vehicle Speed MPH	Ambient Temp. °F	# of Passengers	Total lbs.
Altitude Ft.	% Humidity	Cold Soak Hrs Min	Hot Soak Hrs Min

Weather Conditions

Type of Road

Attachments

[Fuel Leak 1](#)

[Fuel Leak 4](#)

[Fuel Leak 3](#)

[Fuel Leak 2](#)

VIN Remainder 4S4 [REDACTED]	Warranty Start Date 07/27/2005	Production Date 03/21/2005	Car Line BAJA
Original Engine # 426131	Trans. Type Desc. 4-Speed Automatic	Model Year 2005	Model Code 5PE
Color BLK	Option Pkg. TC	Emissions Spec. C	Turbo? Yes
Engine Size 2.5			

[Print QMR](#)

[Back To Search](#)

BY WHAT'S INSIDE™

RECOMMENDED SERVICES

DATE	DESCRIPTION	STATUS	REMARKS

SERVICE HISTORY

DATE	TIME	DESCRIPTION	STATUS	REMARKS

SALES PERSON NO. 169

S E R V I

SALES PERSON NO. 169	65/SURABAYA/4 AT TIRU
[REDACTED]	15814 SUB
[REDACTED]	BLACK/
[REDACTED]	SUZUKI Y
02:56pm 05/28/07 07:00pm	

PLEASE DROP OFF FOR WARRANTY

DATE







Contacts

Primary	Last Name	First Name	Address	City	State	Zip	Relationship	Updated Date
✓	Laurel	Grace	5752 New Castle Dr	Richardson	TX	75082-4135	Owner	8/1/2005 03:18:00 PM

Agreements

Contract Owner	Contract #	Coverage Type	Plan Description	Status	Contract Start Date	Contract Expiration	Contract Termination Date
Grace Laurel	51501	New Gold Plus	6yr/60,000 \$100 Deductible	Active	7/27/2005 12:00:00 AM	7/27/2011 12:00:00 AM	

22-Dec-2008 04:20:13

Page: 1

DEALER VEHICLE INQUIRY
 FOR DEALER: 550102 Needed for Claims passthrough - LMAT

Vin 4S4-BT63CX 55 [REDACTED]
 Description (5PE C BLK) 2005 Baja 4EAT
 Option Description Pw/Pl/Pm/Ac/Cc/Abs,Alwhls/Ke/Dab/Fl/Mr,Ltr/Am/Fm/Cd/Bedcvr
 Model Ext/Int Spec Engine # Ign Key Trans #
 5PE BLK/GRE C 426131 34158 323603
 Dlr Demo Soa Demo Service Contract Case Ship Port
 SAS 020
 Production Date ETA Date Warranty Start Retail Date Retail Delivery
 21-Mar-2005 20-Jun-2005 27-Jul-2005 01-Aug-2005 27-Jul-2005

Salesman: ###-##-7894 Sales Order Type: Wholesale Sale Type: A

ALLOCATED:

SOLD BY:

 SUBARU OF DALLAS 040985 040985
 5403 LEMMON AVENUE
 DALLAS TX 75209

 SUBARU OF DALLAS 040985 040985
 5403 LEMMON AVENUE
 DALLAS TX 75209

PORT ACCESSORIES

PROMO CODE	ACCY CODE	ACCESSORY DESCRIPTION	DATE INSTALLED	ACCY TYPE
	X43	ROADSIDE ASSISTANCE LABEL	07-Jun-2005	A
	XGE	BAJA FLOOR MATS	07-Jun-2005	A
	XGF	BAJA CROSS BARS	07-Jun-2005	A
	XJC	BAJA ORG	07-Jun-2005	A
	XJE	BAJA OIK	07-Jun-2005	A
	XJR	2005 BAJA OIK SUPPLEMENT	07-Jun-2005	A
	XMM	Legacy/Baja Standard Mirror	07-Jun-2005	A

OWNER:

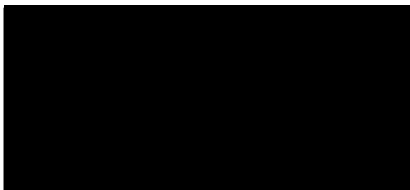

(F)

CO-OWNER:

(H)
 (W)
 (F)

DRIVER:

(H)
 (W)
 (F)

CO-DRIVER:

(H)
 (W)
 (F)

12/22/2008 16:20:13

SUBARU STAR SYSTEM

PAGE: 1

Vehicle Coverage Inquiry

FOR DEALER: 550102 Needed for Claims passthrough - LMAT

 VEHICLE DATA

VIN	MODEL YEAR	MODEL CODE	DESCRIPTION	OPTION CODE
4S4-BT63CX 59 [REDACTED]	2005.0	5PE	(5PE C BLK) 2005 Baja	4EAT TC

TRANS TYPE	SPEC CODE	DEMO IND	ALLOC DEALER	SELLING DEALER	WARR DATE	STR	OWNER
4EAT	C		040985	040985	27-Jul-2005		[REDACTED]

 COVERAGE DETAIL

CLAIM TYPE	LABEL	EFFECTIVE DATE	EXPIRATION DATE	MILEAGE	EXTEN- SION	CONTROL NUMBER	R/C STATUS
WC	Fed Perform	07/27/05	07/27/07	24000	N		
Federal Emissions Performance Warranty							
WC	Brake Pad	07/27/05	07/27/08	36000	N		
Brake Pad Coverage							
WC	New Car Basc	07/27/05	07/27/08	36000	N		
Basic New Car Warranty							
WC	New Car Adj	07/27/05	07/27/08	36000	N		
New Car Adjustment Coverage							
WC	New Car Wear	07/27/05	07/27/08	36000	N		
New Car Wear Item Warranty							
WC	Fed Defect	07/27/05	07/27/08	36000	N		
Federal Emissions Defect Warranty							
WC	Cal Defect	07/27/05	07/27/08	50000	N		
California Emissions Performance & Defect Warrant							
WC	Powertrain	07/27/05	07/27/10	60000	N		
Powertrain Warranty							
WC	Cal Ext Deft	07/27/05	07/27/12	70000	N		
California Emissions Extended Defect Warranty							
WC	Fed Ext Deft	07/27/05	07/27/13	80000	N		

12/22/2008 16:20:13

SUBARU STAR SYSTEM

PAGE: 2

Federal Emissions Extended Defect Warranty

WC	Rust Perf	07/27/05	07/27/10	999999	N
	Rust Perforation Warranty				
WC	Life Seatblt	07/27/05	07/27/55	999999	N
	Lifetime Seatbelt Warranty				
SA	SAS Gold	07/27/05	07/27/11	60000	N
	SAS Gold Coverage				

EXTENSIONS

COVERAGE	REASON	ADDT'L MONTHS	ADDT'L MILES	EFFECTIVE DATE	EXPIRATION DATE	UPDATE DATE	USER
=====	=====	=====	=====	=====	=====	=====	=====
***** NO EXTENSIONS*****							

EXCLUSIONS

EXCLUSION TYPE	EXCLUSION	EFFECTIVE DATE	EXPIRATION DATE	UPDATE DATE	USER
=====	=====	=====	=====	=====	=====
***** NO EXCLUSIONS*****					

SAS CONTRACT

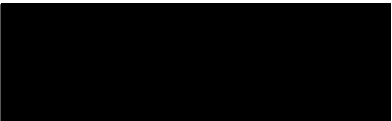
CONTRACT NUMBER	PLAN NUMBER	STATUS	DEDUCT-IBLE	START MILEAGE	CONTRACT OWNER
=====	=====	=====	=====	=====	=====
51501	164	Active	100.00	84	
Effective Date		07/27/05			
Transfer Date		Cancel Date			

VEHICLE COMMENTS

***** NO COMMENTS*****

12/22/2008 16:20:13

SUBARU STAR SYSTEM

PAGE: 1

Vehicle Claim History Report

FOR DEALER: 550102 Needed for Claims passthrough - LMAT

VEHICLE DATA

VIN	MODEL YEAR	OPT CDE	MODEL CODE	DESCRIPTION	DEMO	TRANS TYPE	TRIM STYLE
4S4-BT63CX 55 [REDACTED]	2005.0	TC	5PE	(5PE C BLK) 2		4EAT	null

ALLOC DEALER	SELLING DEALER	SALE DATE	WARRANTY START DATE	SPEC CODE	EXT/INT CLR/CLR
040985	040985	27-Jul-2005	27-Jul-2005	C	BLK/GRE

SAS CONTRACT INFORMATION

START DATE	EXPIRATION DATE	STATUS	OWNER
07/27/05	07/27/11	A	[REDACTED] GRACE A

CLAIM DETAIL

SEQ NUM	CLAIM TYPE	RO / JOB	REGION DEALER	FAIL CODE	DAMAGE CODE	MILEAGE	ENTRY DATE
1	WC	40282	A 040-985	DBA37		31351	09/19/07
2	WC	40282	B 040-985	VOR99		31351	09/20/07
3	PA	42666	A 040-985	FAA42		36114	01/28/08

SEQ NUM	START DATE	COMPLETE DATE	ORIG CODE	PROC DATE	PROC CODE	AUTH CODE	TECHNICIAN ID
1	08/28/07	09/11/07	D	09/20/07	USER		#####2699
2	08/28/07	09/11/07	D	09/20/07	CDS		#####2699
3	01/23/08	01/23/08	D	01/28/08	CDS		#####5152

CLAIM CREDITS / DEBITS

SEQ NUM	CLAIM STATUS	POSTING DATE	TAX AMOUNT	SAS DEDUCT	PNT/MAT AMOUNT	TOWING AMOUNT	RENTAL AMOUNT
1	CR	09/28/07	0.00	0.00	0.00	0.00	0.00
		Paid					
2	CR	09/28/07	0.00	0.00	0.00	0.00	0.00
		Paid					
3	CR	02/29/08	0.00	45.00	0.00	0.00	0.00

12/22/2008 16:20:13

SUBARU STAR SYSTEM

PAGE: 2

Paid

SEQ NUM	ORIGINAL CLAIM	ADJUST AMOUNT	NET CLAIM
1	540.13	0.00	540.13
2	11.34	0.00	11.34
3	88.95	0.00	88.95

TOTAL CLAIMS FOR VEHICLE 55 [REDACTED] 640.42

LABOR INFORMATION

SEQ NUM	LABOR OPER #	LABOR HOURS	ADDT'L HOURS	SUBLET HOURS	SUBLET AMOUNT	CLAIM LABOR
1	471001	0.50	0.00	0.00	0.00	45.00
	FUEL PUMP R&R					
1	475001	0.50	0.00	0.00	0.00	45.00
	FUEL SYSTEM - TESTING					
1	913324	0.80	0.00	0.00	0.00	72.00
	INTERIOR CARPET R&R					
2	101105	0.00	0.00	0.00	11.34	0.00
	VOR Freight Costs - WC or PW Claim					
3	800001	0.50	0.00	0.00	0.00	45.00
	BATTERY TEST AND REPLACE					
TOTALS		2.30	0.00	0.00	11.34	207.00

PARTS INFORMATION

SEQ NUM	PART NUMBER	UNIT QTY	UNIT COST	EXTENDED COST	HANDL- ING	CLAIM PARTS	FAILED PART	RETURN CODE
1	42021AE08A	1	279.95	279.95	0.00	279.95	Y	A50
	PUMP ASSY FUEL							
1	95070AE13A	1	98.18	98.18	0.00	98.18	N	
	COVER R FLOOR							
TOTALS				378.13	0.00	378.13		
2	No Parts Data							
3	SOA821B200	1	88.95	88.95	0.00	88.95	Y	
	PB000825 REPL BATTERY							
TOTALS				88.95	0.00	88.95		

12/22/2008 16:20:13

SUBARU STAR SYSTEM

PAGE: 3

SEQ

NUM

CLAIM COMMENTS

1 CUSTOMER STATES SMELLS FUEL INSIDE CAR FOUND FUEL LEAKING FROM UNDER FUEL TANK AND CHECK ENGINE LIGHT P0171 AND P0230. CHECKED TANK AND FOUND NO RUPTURES OR PUNCTURES. FUEL SYSTEM WOULD NOT HOLD PRESSURE. REMOVED FUEL PUMP ASSEMBLY AND FOUND PLASTIC ELBOW AT TOP OF PUMP BROKEN SPILLING FUEL INTO AND UNDER VEHICLE. CARPET AND SEATS SOAKED IN FUEL. REMOVED REAR CARPET AND SEAT. CLEANED AND AIRATED VEHICLE. REPLACED CARPET INSULATION AND FUEL PUMP.

2 FREIGHT

2 FREIGHT

3 CUSTOMER REQUESTS ELECTRICAL SERVICE. TURNS OVER SLOWLY. TESTED BATTERY. TEST STATED REPLACE BATTERY

9-a. Inspection Standard (1/3)

P1/3

DISTRIBUTION	SUBARU SYMBOLS FROM DRAWING		INSPECTION STANDARD		No		SUPPLIER NAME				
	<input type="checkbox"/> C <input type="checkbox"/> N <input type="checkbox"/> S <input type="checkbox"/> IMPORTANT PARTS						HITACHI UNISIA AUTOMOTIVE,LTD				
	FOR CUSTOMER USE ONLY		PART NAME		ISSUED DATE						
			PUMP ASSY FUEL		MAY.30'03						
	DATE		PART NUMBER		MODEL		UNISIA JKC STEERING SYSTEM, LTD QUALITY ASSURANCE DEPT AKITA PLANT				
			▲ 42021 AE02A ▲ 42021 AE03A ▲ 42021 AE05A 42021 AE06A 42021 AE07A 42021 AE08A		63P		MANAGER				
							Y.HARIGAYA				
	APPROVAL		CHECK		CHECK		RESPONSIBLE				
							M.TAGUCHI				
PAGE NO		ENGINEERING CHANGE NO		REVISED REASON		DATE		SUPPLIER SIGNATURE		FOR CUSTOMER USE ONLY	
N ALL		68L-M1661 68L-M1820		SIA 63P SOP						DATE APPROVAL	
1 P1,P2				PART NUMBER ADDED		JUN.5'03		<i>Y. Harigaya</i>			

9-a. Inspection Standard (2/3)

No	ITEM	CRITERION	TEST METHOD	SECTION	SIZE	CONTROL METHOD	CUSTOMER NOTES
1.	APPEARANCE	1) SEALED SURFACE OF UPPER PLATE SHALL BE SMOOTH AND WITHOUT BURRS AND FLAWS.	VISUAL CHECK	Manu- facture	ALL PARTS	-	
		2) PIPE END SHALL BE FREE FROM FLAWS AND DENTS.					
		3) HOSE ACCEPTANCE AREA SHALL BE SMOOTH AND WITHOUT BURRS, FLAWS.					
		4) WELDS AND COMPONENT PARTS SHALL BE FREE FROM CRACKS AND FLAWS.					
		5) NO BROWN RUST PERMITTED.					
		6) GASKET SHALL BE FREE FROM FLAWS AND DEFORMATION					
2.	AIR-TIGHTNESS OF UPPER PLATE	NO LEAKS PERMITTED.	PRESSURE GAUGE	Manu- facture	ALL PARTS	-	
3.	INSULATION RESISTANCE BETWEEN UPPER PLATE AND TERMINAL	3MΩ MIN	500V INSULATION RESISTANCE TESTER	Inspection	3/month	Inspection Report	
4.	AIR-TIGHTNESS OF F/P DISCHARGE PIPE JOINT AND ELEMENT AASY-F/F JOINT	AT OIL PRESURE OF 490kpa . SUCH DEGREE OF LEAK AS SEEPAGE IS PERMISSIBLE WHILE SCATTERING IS NOT PERMISSIBLE	VISUAL CHECK	Inspection	3/month	Inspection Report	
5.	STRENGTH OF CONNECTOR	NO CRACKS AND BRAKE PERMITTED(APPLY 196N IN THE DIRECTION OF F)	VISUAL CHECK	Inspection	3/month	Inspection Report	
6.	STRENGTH OF TUBE	NO CRACKS AND BRAKE PERMITTED(APPLY 196N IN THE DIRECTION OF F1,F2)	VISUAL CHECK	Inspection	Update of the DIE	Inspection Report	
7.	GAUGE CHARACTERISTICS	LEVEL	RESISTANCE TESTER	Manu- facture	ALL PARTS	-	
		RESISTANCE VALUE(Q)					
8.	DETACHING FORCE OF GAUGE ATTACHMENT	98N MIN	HANDPRESS	Inspection	Update of the DIE	Inspection Report	
9.	JET PUMP CHARACTERISTICS	1) SUCTION FLOW RATE : 40l/min MIN(WHEN RETURN FLOW RATE IS 120l/h UNDER ACTUALLY MOUNTED	J/P CHARACTERISTICS TESTER	J/P Supplier	ALL PARTS	Supplier Report	
		2) PUMP SHALL ENSURE PUMPING UP OF FUEL WITHIN 1min MIN(WHEN RETURN FLOW RATE IS 40l/h UNDER ACTUALLY MOUNTED CONDITIONS					
		3) INTERNAL PRESSURE OF JET PUMP:58.8kpa MAX(WHEN RETURN FLOW RATE IS 40l/h UNDER ACTUALLY MOUNTED CONDITIONS					
10.	FUEL PUMP CHARACTERISTICS (INITIAL)	1) DISCHARGE FLOW RATE : AT 12V, 300kpa ⚠ 42021 AE02A,AE05A,AE06A 65-105l/h ⚠ 42021 AE03A,AE07A 85-125l/h 42021 AE08A 130-170l/h	F/P CHARACTERISTICS TESTER	Manu- facture	ALL PARTS	-	
		2) CURRENT : AT 12V, 300kpa ⚠ 42021 AE02A,AE05A,AE06A 3.6A MAX ⚠ 42021 AE03A,AE07A 5.0A MAX 42021 AE08A 6.4A MAX					

9-a. Inspection Standard (3/3)

No	ITEM	CRITERION	TEST METHOD	SECTION	SIZE	CONTROL METHOD	COSTOMER
							NOTES
10.	FUEL PUMP CHARACTERISTICS (INITIAL)	3) RELIEF VALVE SHUT-OFF DISCHARGE PRESSURE: 677kpa MAX	F/P	Manu- facture Inspection	ALL PARTS 3/month	Inspection Report	
		4) DISCHARGE FLOW RATE: AT 8V. 250kpa 5l/h MIN	CHARACTERISTICS TESTER				
11.	RELIABILITY TEST	BY DRAWING ※ We choose a necessary items in establishing and design change.	RELIABILITY TESTER				

[PRODUCT SKETCH]

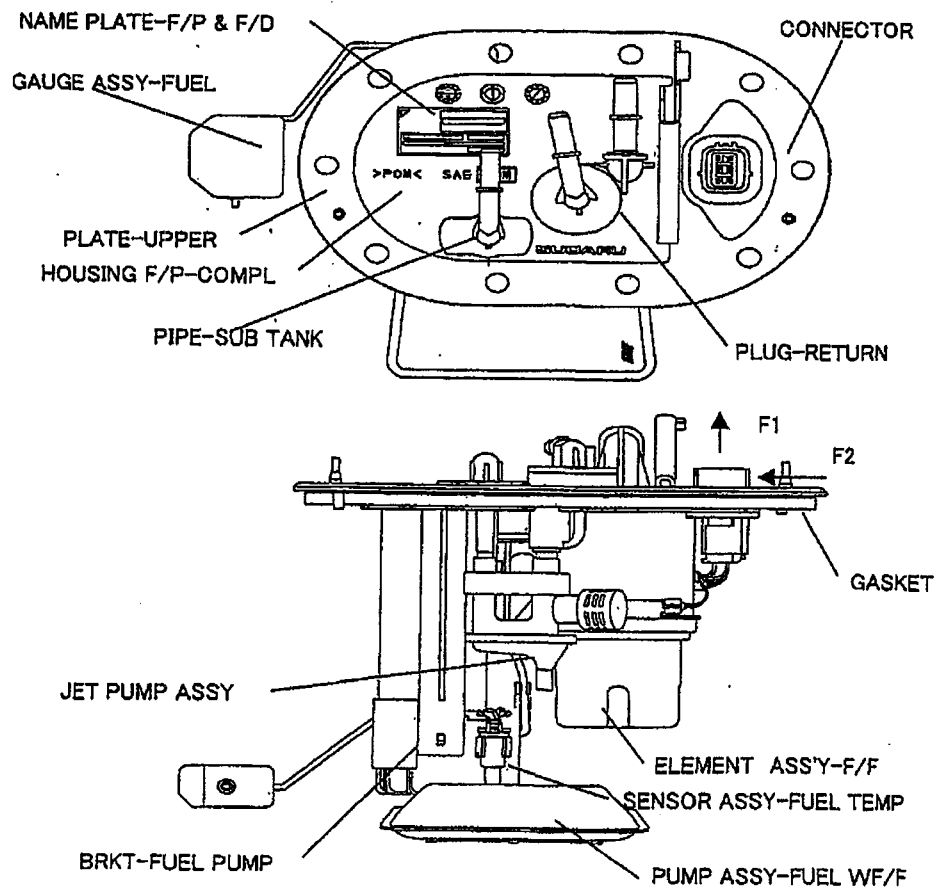

9-b. Dimension Data (1/3)

2003年 5月26日 18時01分

BOSCH K. K. /YOKOHAMA Purchasing

NO. 6854 P. 24

Production Prt Approval—Dimensional Results

Page 1 of 3 Pages

SUPPLIER				PART NUMBER							
Hitachi Unisia Automotive Corporation				42021 AEO8A (A40-000 R98)							
NAME OF INSPECTION FACILITY				PART NAME							
				PUMP COMPL-IN TANK							
ITEM	DIMENSION/SPECIFICATION			SUPPLIER MEASUREMENT RESULTS						OK	NOT OK
	TEST ITEMS	STANDARD	No.	1	2	3	4	5	6		
1	Mass	1269g -5+5		1265	1264	1268	1266	1267	1267	OK	
2	Appearance	Free from clack etc.		OK	OK	OK	OK	OK	OK	OK	
3	Air tightness	No leak.		OK	OK	OK	OK	OK	OK	OK	
4	Insulation between plate and terminal	$3M\Omega \leq$		OK	OK	OK	OK	OK	OK	OK	
5	Gauge Resistance	2.5 -2.0+0Ω (FULL)		1.3	1.3	1.2	1.3	1.2	1.3	OK	
6	↑	52.5 0+2.0Ω (EMPTY)		53.6	53.7	53.6	53.6	53.6	53.6	OK	
7	Fuel flow rate	130~170 l/h (12V,300kPa)		153.0	140.0	141.5	152.5	145.0	141.0	OK	
8	↑	≥ 5 l/h (8V,250kPa)		59.0	51.5	50.0	52.5	50.5	51.0	OK	
9	Operation current	$\leq 6.4A$ (12V,300kPa)		6.05	5.63	5.48	5.37	5.84	5.66	OK	
10	Closed pressure	$\leq 677kPa$ (12V)		611	593	601	590	608	606	OK	
11	Pump noise	Reverberation chamber method -7dB max		-9.15	-9.52	-8.47	-8.15	-9.26	-8.55	OK	
12	Dimensional	① $\phi 12.95 \pm 0.2$		12.94	12.95	12.94	12.95	12.94	12.95	OK	
13	↑	② $\phi 9.49 \pm 0.06$		9.44	9.44	9.44	9.44	9.44	9.44	OK	
14	↑	③ 2.2 ± 0.2		2.04	2.03	2.02	2.02	2.03	2.04	OK	
15	↑	④ $\phi 8.53 \pm 0.1$		9.45	9.45	9.44	9.43	9.45	9.47	OK	
16	↑	⑤ 1.2 ± 0.1		1.18	1.17	1.18	1.12	1.18	1.17	OK	
17	↑	⑥ 19.52 ± 0.25		19.57	19.54	19.55	19.53	19.58	19.55	OK	
18	↑	⑦ 1.82 ± 0.1		1.84	1.84	1.83	1.84	1.84	1.84	OK	
19	↑	⑧ $\phi 11.1 \pm 0.3$		10.95	10.96	10.96	10.96	10.96	10.98	OK	
20	↑	⑨ $\phi 7.95 \pm 0.05$		7.91	7.90	7.91	7.90	7.90	7.91	OK	
21	↑	⑩ 1.2 ± 0.3		1.04	1.05	1.04	1.05	1.04	1.04	OK	
22	↑	⑪ 22.5 ± 0.5		22.75	22.77	22.78	22.77	22.76	22.66	OK	
23	↑	⑫ 1.6 ± 0.3		1.65	1.68	1.66	1.68	1.67	1.66	OK	
24	↑	⑬ 2.2 ± 0.3		2.01	2.01	2.00	1.98	2.01	2.00	OK	
25	↑	⑭ $\phi 11.1 \pm 0.3$		11.04	11.01	11.00	11.02	11.00	11.06	OK	
26	↑	⑮ $\phi 7.95 \pm 0.05$		7.90	7.90	7.90	7.90	7.91	7.91	OK	
27	↑	⑯ 1.2 ± 0.3		1.28	1.25	1.27	1.25	1.34	1.29	OK	

EXPLANATION COMMENTS

Design changed parts

(CONTENT)

• POLYMER MAKER CHANGED O-RING, F/F

NEW : JAPAN ZEON CO.LTD MODE (MATERIAL:PO-NBR) ← OLD : JSR CO.LTD MODE (MATERIAL:S-NBR)

• MATERIAL CHANGED SEAL-F/F

NEW : PO-NBR ← OLD : FKM

Hitachi Unisia Automotive Corporation

QUALITY ASSURANCE SECTION,UNISIA JKC STEERING SYSTEM CORPORATION AKITA PLANT

MANAGER

J. Iwagawa

SIGNATURE

H. Goshida

TITLE

STP-03-007

DATE

May - 13-'03

9-b. Dimension Data (2/3)

2003年 5月26日 18時01分

BOSCH K. K./YOKOHAMA Purchasing

NO. 6854 P. 25

Production Prnt Approval—Dimensional Results

Page 2 of 3 Pages

SUPPLIER Hitachi Unisia Automotive Corpration				PART NUMBER 42021 AE08A (A40-000 R98)							
NAME OF INSPECTION FACILITY				PART NAME PUMP COMPL-IN TANK							
ITEM	DIMENSION/SPECIFICATION			SUPPLIER MEASUREMENT RESULTS						OK	NOT OK
	TEST ITEMS	STANDARD	No.	1	2	3	4	5	6		
28	Dimensional	⑰ 22.5 ±0.5		22.77	22.75	22.79	22.77	22.78	22.74	OK	
29	↑	⑱ 1.6 ±0.3		1.57	1.56	1.58	1.58	1.57	1.58	OK	
30	↑	⑲ 2.2 ±0.3		2.00	2.01	2.02	2.00	2.02	2.02	OK	
31	↑	㉑ 174 ±2		172.80	175.15	174.25	173.80	172.75	175.10	OK	
32	↑	㉒ 131.7 ±5		132.15	131.84	131.57	131.73	131.82	131.95	OK	
33	↑	㉓ 13.2 ±3		11.20	11.75	10.70	11.10	11.85	11.05	OK	
34	↑	㉔ 157.6 ±3		156.45	155.25	155.80	155.95	156.20	155.45	OK	

EXPLANATION COMMENTS

SIGNATURE *H. Yoshida* TITLE STP-03-007 DATE May - 13-'03

9-b. Dimension Data (3/3)

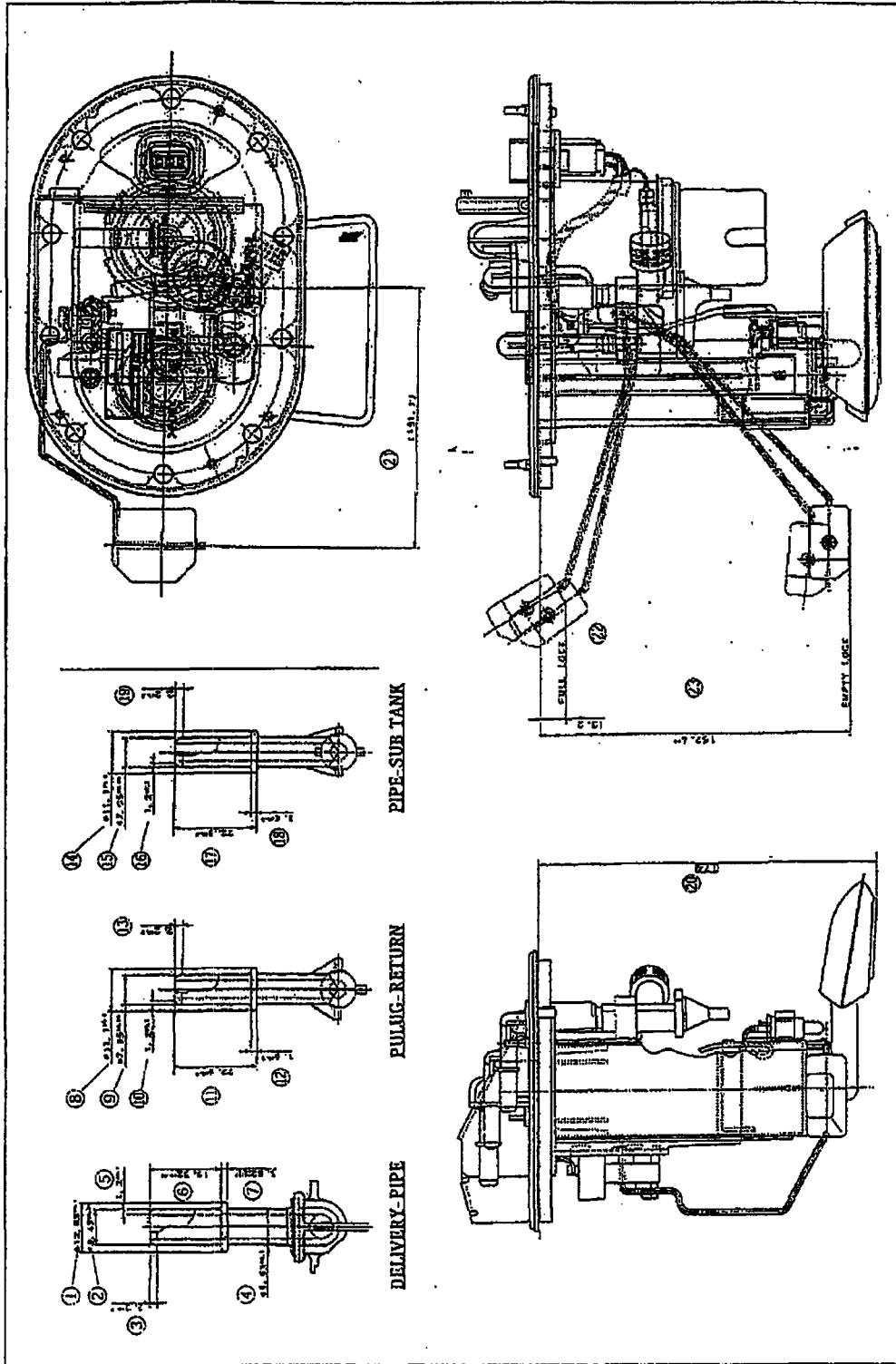

9-b. Engineering Test Data (1/1)

LABORATORY RESULT		UNISIA JKC STEERING SYSTEM CORPORATION		DATE: JUN.5.2003													
No.	ITEM	TEST METHOD	CRITERION	RESULTS OF TEST													
A	THERMAL CYCLE TEST	CONDUCT 100CYCLES OF A THERMAL CYCLE TEST CONSISTING OF 50°C, 95%RH/4h → 20°C/7.5h → 20°C/0.5h → 80°C/11h → 20°C/0.5h AS ONE CYCLE	AS SHOWN TABLE-1 ITEM 1) 2) 3) 4) 5) 6) 9)	<table border="1"> <tr> <th colspan="2">SAMPLES</th> <th>JUDGE- MENT</th> </tr> <tr> <th>No.1</th> <th>No.2</th> <th></th> </tr> <tr> <td>1) OK</td> <td>OK</td> <td rowspan="3">OK</td> </tr> <tr> <td>2) OK</td> <td>OK</td> </tr> <tr> <td>3) OK</td> <td>OK</td> </tr> </table> <p>* TABLE-1, 3) 4) 5) 6) 9) ITEM is to be unnecessary in the evaluation for 68J and same specification.</p>	SAMPLES		JUDGE- MENT	No.1	No.2		1) OK	OK	OK	2) OK	OK	3) OK	OK
SAMPLES		JUDGE- MENT															
No.1	No.2																
1) OK	OK	OK															
2) OK	OK																
3) OK	OK																
B	FUEL IMMERSION TEST	IMMERSIVE TEST SAMPLE IN THE FOLLOWING FUELS AT 80°C FOR 72h ① UNLEADED REGULAR GRADE GASOLINE ② 20% ETHANOL-ADDED UNLEADED REGULAR GRADE GASOLINE ③ 15% METHAOL-ADDED UNLEADED REGULAR GRADE GASOLINE ④ 15% MTBE-ADDED UNLEADED REGULAR GRADE GASOLINE	AS SHOWN TABLE-1 ITEM 1) 2) 3) 4) 5) 6) 9)	<table border="1"> <tr> <th colspan="2">SAMPLES</th> <th>JUDGE- MENT</th> </tr> <tr> <th>No.1</th> <th>No.2</th> <th></th> </tr> <tr> <td>1) OK</td> <td>OK</td> <td rowspan="3">OK</td> </tr> <tr> <td>2) OK</td> <td>OK</td> </tr> <tr> <td>3) OK</td> <td>OK</td> </tr> </table> <p>* TABLE-1, 3) 4) 5) 6) 9) ITEM is to be unnecessary in the evaluation for 68J and same specification.</p>	SAMPLES		JUDGE- MENT	No.1	No.2		1) OK	OK	OK	2) OK	OK	3) OK	OK
SAMPLES		JUDGE- MENT															
No.1	No.2																
1) OK	OK	OK															
2) OK	OK																
3) OK	OK																
C	SALT SPRAY TEST	CONDUCT TEST ON THE AREA EXPOSED TO THE TANK IN ACCORDANCE WITH JIS Z 2371.(UNDER ACTUALLY MOUNTED CONDITIONS) (5000h)	AS SHOWN TABLE-1 ITEM 1)	<table border="1"> <tr> <th colspan="2">SAMPLES</th> <th>JUDGE- MENT</th> </tr> <tr> <th>No.1</th> <th>No.2</th> <th></th> </tr> <tr> <td>1) OK</td> <td>OK</td> <td>OK</td> </tr> </table>	SAMPLES		JUDGE- MENT	No.1	No.2		1) OK	OK	OK				
SAMPLES		JUDGE- MENT															
No.1	No.2																
1) OK	OK	OK															
D	COMPOSITE VIBRATION TEST	* DIRECTION OF VIBRATION: VERTICAL * VIBRATION ACCELERATION AND FREQUENCY SHALL BE AS PER THE CHART SHOWN RIGHT. * SWEEP CONDITIONS: 5min/CYCLE (LOG SWEEP) * TEMPERATURE CONDITION: AS PER ITEM A) THERMAL CYCLE TEST. * TEST DURATION: 120h.	AS SHOWN TABLE-1 ITEM 1) 2)	<p>* It competes in the evaluation at 68J.</p>													
E	HIGE-TEMPERATURE TEST	EXPOSURE TEST SAMPLE TO STATIONARY AIR OF 80°C FOR 240h.	AS SHOWN TABLE-1 ITEM 1) 2) 3) 4) 5) 6) 9)	<table border="1"> <tr> <th colspan="2">SAMPLES</th> <th>JUDGE- MENT</th> </tr> <tr> <th>No.1</th> <th>No.2</th> <th></th> </tr> <tr> <td>1) OK</td> <td>OK</td> <td rowspan="3">OK</td> </tr> <tr> <td>2) OK</td> <td>OK</td> </tr> <tr> <td>3) OK</td> <td>OK</td> </tr> </table> <p>* TABLE-1, 3) 4) 5) 6) 9) ITEM is to be unnecessary in the evaluation for 68J and same specification.</p>	SAMPLES		JUDGE- MENT	No.1	No.2		1) OK	OK	OK	2) OK	OK	3) OK	OK
SAMPLES		JUDGE- MENT															
No.1	No.2																
1) OK	OK	OK															
2) OK	OK																
3) OK	OK																

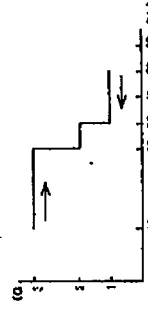

QUALITY ASSURANCE SECTION, AKITA PLANT

MANAGER *Y. Harigaya*
Y. HARIGAYA



CHARGE *M. Taguchi*
M. TAGUCHI

9-b. Initial Sample Report (1/1)

ORIGINAL RECEIVED

SIA INITIAL SAMPLE REPORT (ISR) APR 1 2003 Page 1
 SUBARU - ISUZU AUTOMOTIVE INC. of

Submission Information
 Part Number: 42021AE08A Drawing Number: 420-900-396 Rev 2
 Part Description: Fuel Pump Assy.
 Engineering Change Level: M1920 S or LDS Number: _____ Tier (if applicable): _____

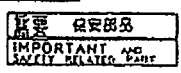
Classification of Part (Check all that are applicable):
ISUZU SYMBOLS FROM DRAWING **SUBARU SYMBOLS FROM DRAWING**
  
 VITAL: ___ SAFETY: ___ FEDERAL: ___ EXHAUST: ___ NOISE: ___ SAFETY: VITAL: ___
 IF NONE OF THESE SYMBOLS ARE ON THE DRAWING: GENERAL PARTS

Reason for Submission:
 Initial Submission Change in Subcontractor Other: _____
 Correction Discrepancy Tooling Change
 Engineering Change(s) Per Process Change Request Approval
 Previous ISR Log Number for this Part: _____ Process Change Log Number (if applicable): _____

Submission Check List
 Correct Number of Samples Material Test Certifications Inspection Standards
 Initial Sample Data BS Test Data QC Process Charts
 Ballooned Drawings/Specifications Reliability Test Data Process FMEA
 Auxiliary Drawings/Sketches QC Plan Process Capability Studies

Supplier Information
 Supplier: Bosch (Supplier Name) A2260C (Supplier Code)
 Supplier Manufacturing Location: UO - Japan (Street address)
Yokote - Shi (City) AKITA - Ken (State/Province) _____ (Postal Code)
 _____ (Phone Number)
 _____ (Fax number)
 I certify that the samples supplied to SIA meet the requirements of the Supplier Quality Manual. Samples are from Production Tooling / Materials and are representative of Production Processing.

SIA to complete this section **SUBMISSION STATUS** Job Conf. # _____
 Approved On Initial Flow Off Initial Flow
 Limited Approval and On Initial Flow Quantity or Time Frame: 8/31/03
 Rejected Comments: See 42021AE08A for details
 Signature: [Signature] ATTN: (Your Supplier Quality Assurance Engineer's Name)
 Title: SSA - CAL. Eng. Dept. Supplier Quality Assurance Department
 Date: 4/27/03 Subaru-Isuzu Automotive Inc.
 5500 State Road 38 East
 PJI19 P.O. Box 5689
 Lafayette, IN 47903

9-c. Subaru Supplier Quality Manual (1/2)

FHI BR224 Ver.04.04

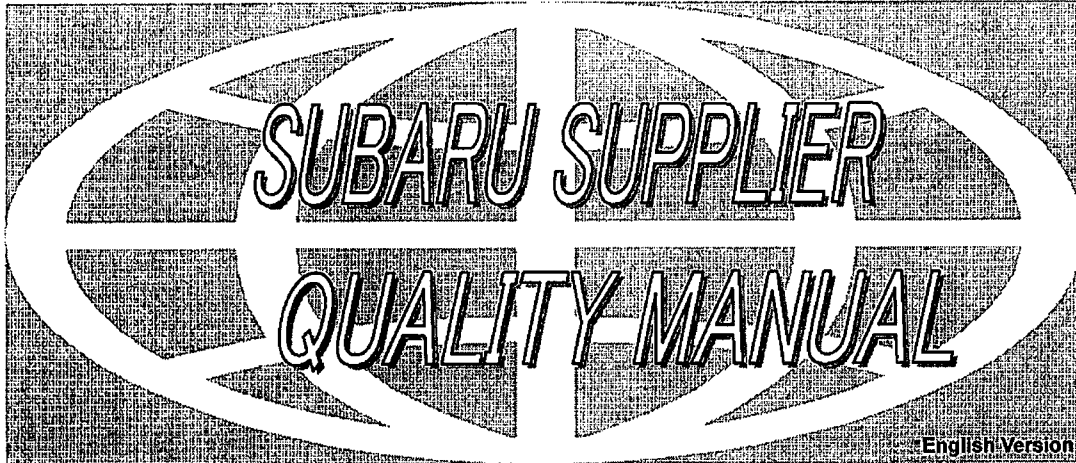

4th-04 Edition (FHI/SIA unified Ver.) Issued: May 15, 2008

 FUJI HEAVY INDUSTRIES LTD.
 SUBARU of INDIANA AUTOMOTIVE INC.

Copyright©2008 FHI. All rights reserved.

9-c. Subaru Supplier Quality Manual (2/2)

Copyright©2008 FHI. All rights reserved.



Deliverables	-----	Task Timing	Daily Control
Specified Form	-----	Submission Timing	At request
Task Owner	Supplier	Submission Level	At request
Customer	FHI MQC SIA SQA		

Purpose

Establish Record Retention & Report.
 The Quality Record is used in Daily Quality Control, as well as e.g. finished vehicle stage, at occurrence of quality problems in the process of use at market, and at occurrence of judicial action. It is also an important document that will be needed in the execution of an appropriate countermeasure. The supplier stores it for the period needed and it shall be submitted in case there is a submission request from FHI / SIA SQA.

Requirement & Methodology

Retention and Submission of Quality Record
 1. The supplier shall improve continuously parts quality and Quality Assurance System by control the following documentation.
 (1) Standards
 (2) Manufacture Control Record
 (3) Record of Inspection/Test Result
 (4) Record of Accuracy Control of Measuring Instrument
 (5) Inspection Record/Instruction Record of subcontractors
 (6) Quality Failure Record
 2. The retention period of record is ten years for Important and Safety Related Parts and Important Parts, and three years (the record shall reckon from preparation date, and the standards shall reckon from the end of model production of vehicle in question of this document text) for General Parts (includes accuracy control record of measuring instruments).
 3. When submission of Quality Record of parts is requested from the Manager of FHI Manufacturing Quality Control Section / SIA SQA, this shall be promptly submitted.

Remarks

Includes 2nd Tier Supplier

FHI BR 224 Ver. 04.04	Revision History	2002.10	4 th -01 Edition	2008.5.15	4 th -04 Edition
		2008.4.26	4 th -03 Edition		

Copyright©2008 FHI. All rights reserved.

Modification History of Fuel Pump Assembly on '04-'06MY Baja Vehicle

Part No.: 42021AE06A (2.5L NA) & 42021AE08A (Turbo)

Drawing Modification No.	Drawing Release Date	Engineering Change Summary No.	Content of Drawing Release
00	2/26'02	66L-M1488	<p><u>Initial drawing is released to cope with '04MY Legacy Tier II /Near Zero.</u> Material of gasket was changed to NBR (Acrylonitrile-butadiene rubber) against '04MY Legacy PZEV model.</p>
01	9/10/'02	66L-M1753	<p><u>(1)Amount of discharge flow of Fuel Pump Assembly is increased on Turbo model.</u> The amount of discharge flow is changed to 130L/h which is equivalent to turbo model for Japanese domestic market.</p> <p><u>(2)Fuel Filter is built in Fuel Tank.</u> The change is made to lower fuel temperature in the same way as done on '04MY Legacy PZEV/Near Zero model.</p>
02	4/4/'03	66L-M1920	<p><u>(1)Supplier delivery specification drawing for 66L-M1753 is converted to FHI's drawing.</u></p> <p><u>(2)Modified items incorporated in FHI's drawing.</u></p> <ul style="list-style-type: none"> -Flange of PACK F/P is discontinue , and polymer is changed. -Polymer of O-RING F/F is changed. -Material of SEAL F/F is changed. -Part number of PUMP WITH FILTER B contained in 42021AE08 is changed from 42022AE011 to 42022AE01B.
03	1/23/'07	66L-M2190	<p><u>Component parts available for spare are clarified.</u></p>

Engineering change was incorporated in production from 66L-M1920.

None of engineering change was incorporated in production after 66L-M1920.

12. Recommended Grade of Fuel (1/2)



GAS STATION REFERENCE

Fuel:

▼ **Non-turbo models**

Use only unleaded gasoline with an octane rating of 87 AKI or higher.

▼ **Turbo models**

Use premium unleaded gasoline with an octane rating of 91 AKI or higher. If premium unleaded gasoline is not available, regular unleaded gasoline with octane rating of 87 AKI or higher may be temporarily used. For optimum engine performance and driveability, it is required that you use premium grade unleaded gasoline.

■ **Fuel octane rating**

This octane rating is the average of the Research Octane and Motor Octane numbers and is commonly referred to as the Anti Knock In-

dex (AKI). Refer to "Fuel" section in this manual.

Fuel capacity:

16.9 US gal (64 liters, 14.1 Imp gal)

Engine oil:

Use only API classification SM with the words "ENERGY CONSERVING" and the ILSAC certification mark (starburst mark) displayed on the container (ILSAC GF-4).

Engine oil capacity:

4.2 US qt (4.0 liters, 3.5 Imp qt)

Cold tire pressure:

Front	33 psi (230 kPa, 2.3 kgf/cm ²)
Rear	33 psi (230 kPa, 2.3 kgf/cm ²)

12. Recommended Grade of Fuel (2/2)

Starting and operating

Fuel

CAUTION

Use of a fuel which is low in quality or use of an inappropriate fuel additive may cause engine damage.

Fuel requirements

Non-turbo models

The 2.5-liter engine is designed to operate using unleaded gasoline with an octane rating of 87 AKI or higher.

Turbo models

The 2.5-liter turbo engine is designed to operate using premium unleaded gasoline with an octane rating of 91 AKI or higher. If premium unleaded gasoline is not available, regular unleaded gasoline with an octane rating of 87 AKI or higher may be temporarily used. For optimum engine performance and driveability, it is required that you use premium grade unleaded gasoline.

Fuel octane rating

This octane rating is the average of the Research Octane and Motor Octane numbers and is commonly referred to as the Anti Knock Index (AKI).

Using a gasoline with a lower octane rating can cause persistent and heavy knocking, which can damage the engine. Do not be concerned if your vehicle sometimes knocks lightly when you drive up a hill or when you accelerate. See your dealer or a qualified service technician if you use a fuel with the specified octane rating and your vehicle knocks heavily or persistently.

Unleaded gasoline

The neck of the fuel filler pipe is designed to accept only an unleaded gasoline filler nozzle. Under no circumstances should leaded gasoline be used because it will damage the emission control system and may impair driveability and fuel economy.

Gasoline for California-certified LEV

Your vehicle was certified to California's low emission vehicle (LEV) standards as indicated on the underhood tune-up label, it is designed to optimize engine and emission control system performance with gasoline that meets the clean burning low-sulfur California gasoline specifications. If you live in any other state than California, your vehicle will operate on gasoline meeting Federal specifications. Gasoline sold outside

California is permitted to have higher sulfur levels, which may affect the performance of your vehicle's catalytic converter and may produce a sulfur exhaust odor or smell. SUBARU recommends that you try a different brand of unleaded gasoline having lower sulfur to determine if the problem is fuel related before returning your vehicle to an authorized dealer for service.

MMT

Some gasoline contains an octane-enhancing additive called MMT (Methylcyclopentadienyl Manganese Tricarbonyl). If you use such fuels, your emission control system performance may deteriorate and the CHECK ENGINE warning light/Malfunction indicator lamp may turn on. If this happens, return to your authorized SUBARU Dealer for service. If it is determined that the condition is caused by the type of fuel used, repairs may not be covered by your warranty.

Gasoline for cleaner air

Your use of gasoline with detergent additives will help prevent deposits from forming in your engine and fuel system. This helps keep your engine in tune and your emission control system working properly, and is a way of doing your part for cleaner air. If you continuously use a high quality fuel with the proper detergent and other additives, you should never need to add any

fuel system (Many gasolins oxygenates. air cleaner. (Methyl Tertiary alcohol) may contain no more proper opera

In addition, s ing reformula vehicle emis: formulated g If you are not ask your serv tains deterge been reformu

As additional vehicle as ex • Fuel shoul no lower than • Methanol (mixed with ur in your vehic fuel mixture , quantities of t

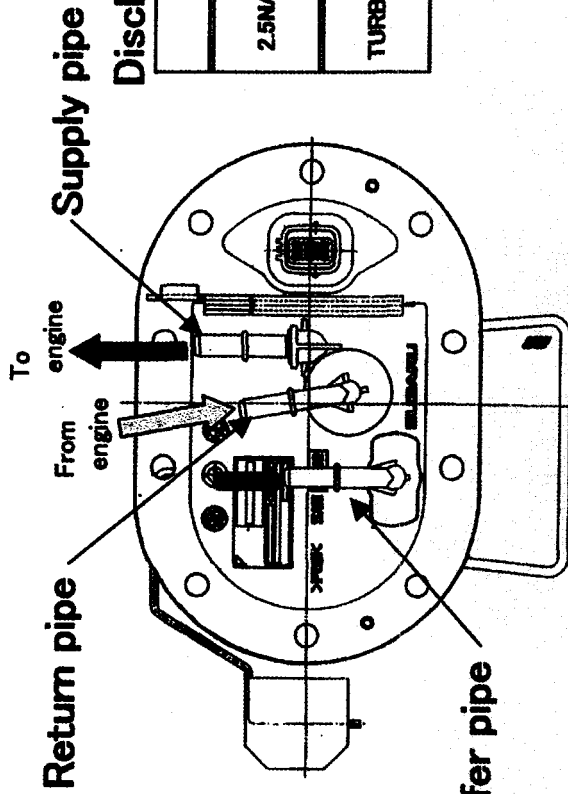

Discharge flow rate

TEST FUEL PUMP	TEST FUEL PUMP	TERMINAL VOLTAGE	DISCHARGE PRESSURE	DISCHARGE FLOW	TEST FUEL		
2.5NA	TURBO	20 ^{±5} °C	12 ^{±0.1} V	300 kPa	Initial	65 ~ 105 l/h	GASOLINE
					After endurance	65 l/h MIN.	
TURBO	TURBO	20 ^{±5} °C	12 ^{±0.1} V	300 kPa	Initial	130 ~ 170 l/h	
					After endurance	130 L/h MIN.	

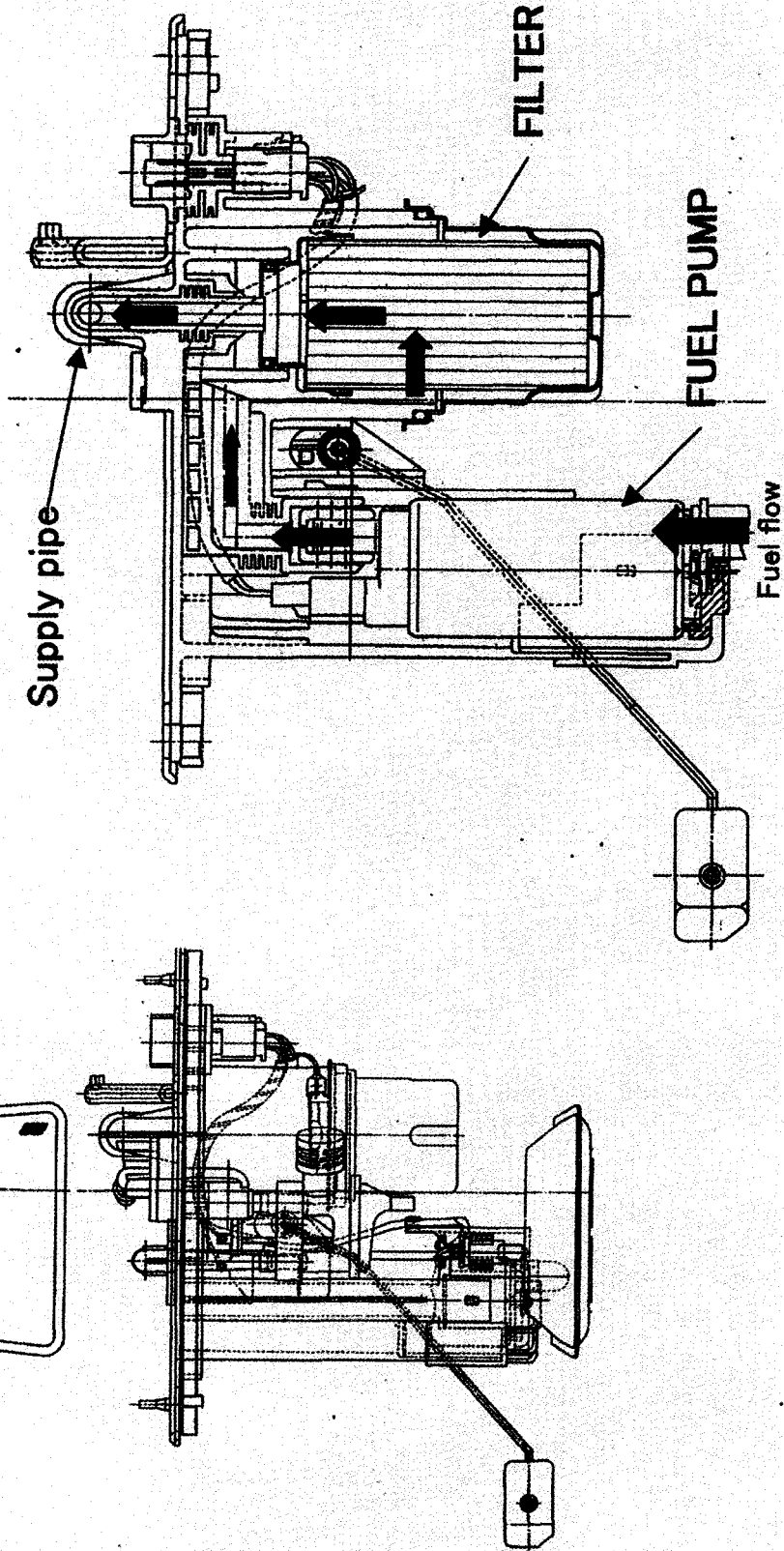

2004-2006MY

Baja Fuel system

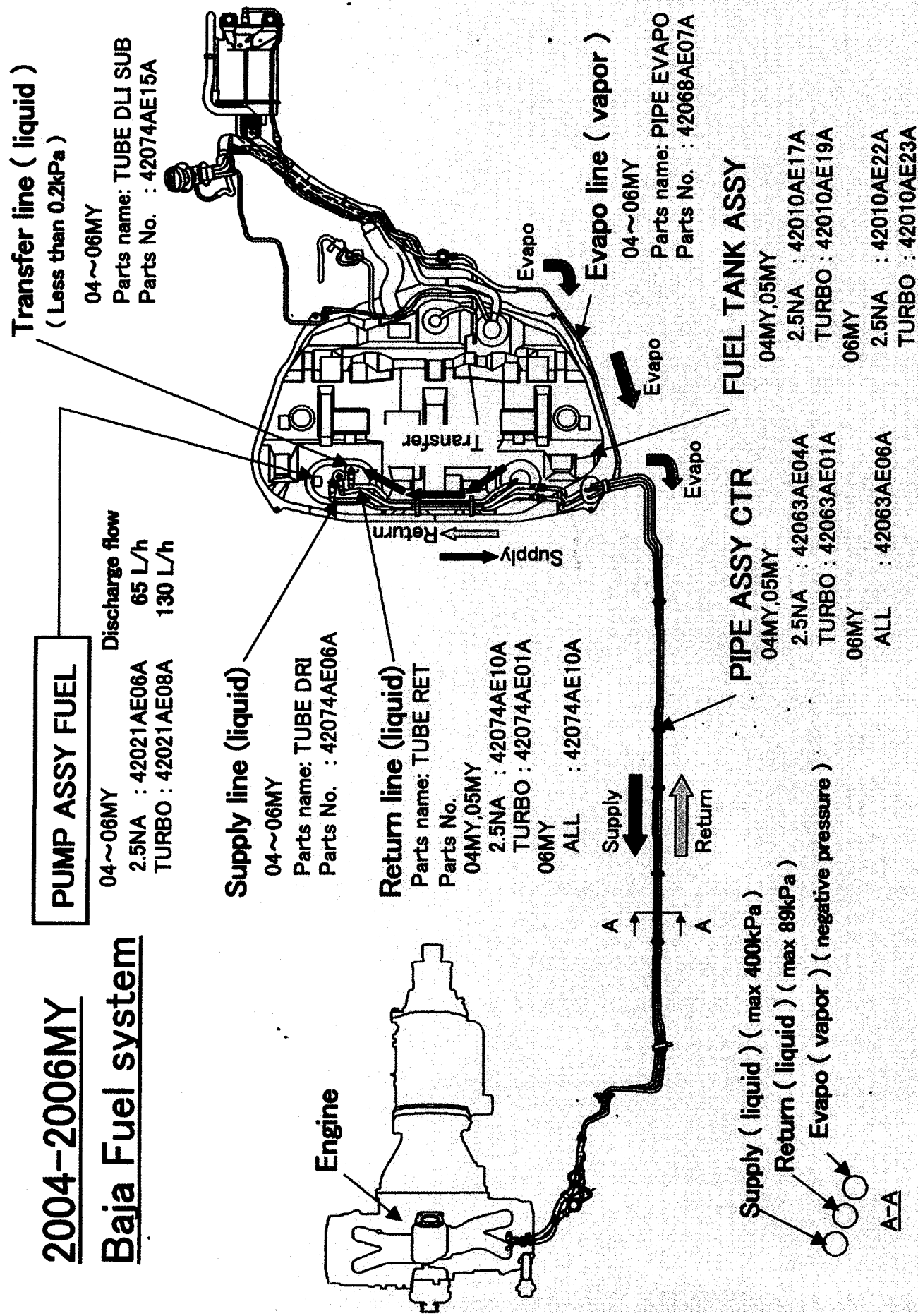

Rear Seat Baja Turbo

Photo 1

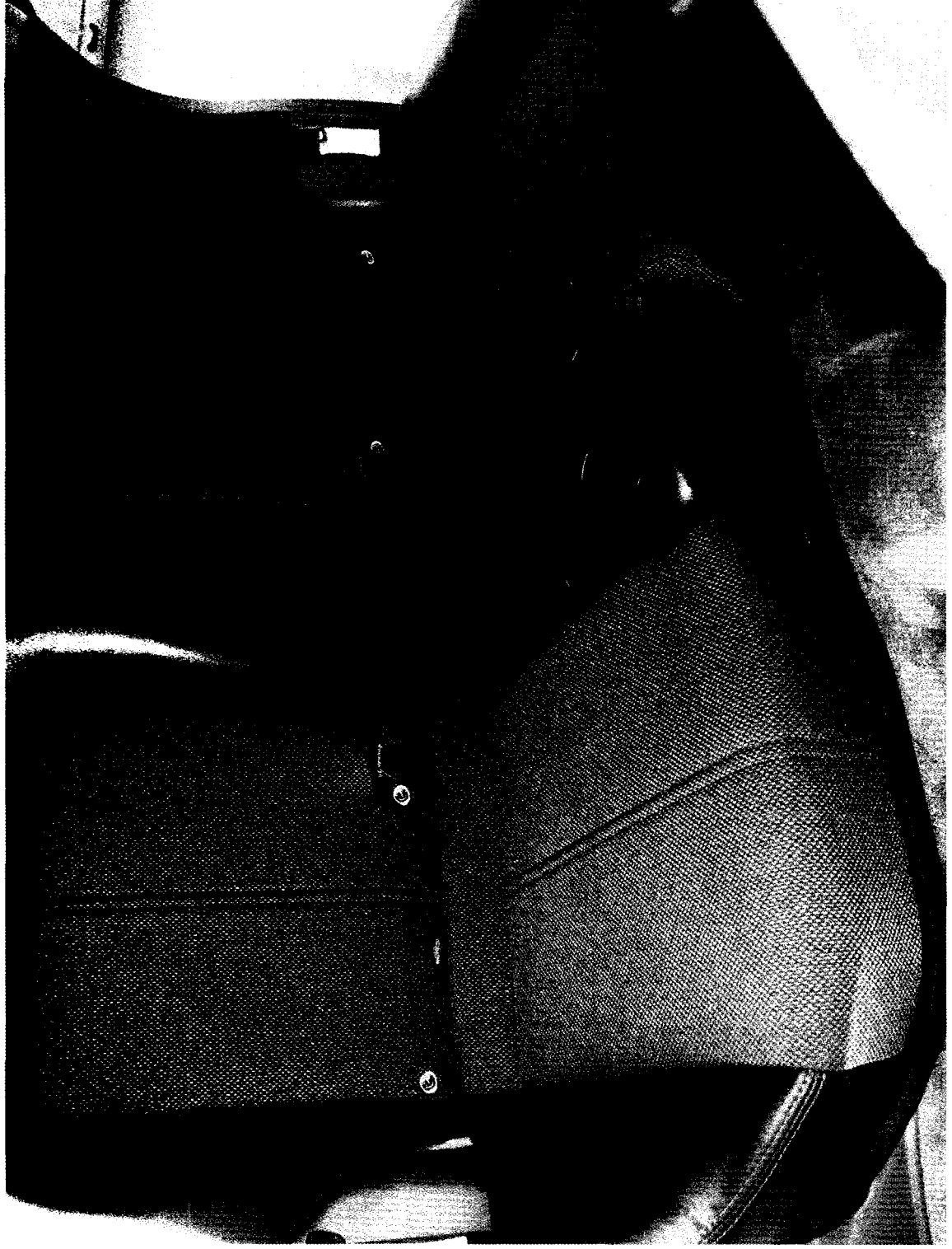

Rear Seat Baja Turbo

Photo 2

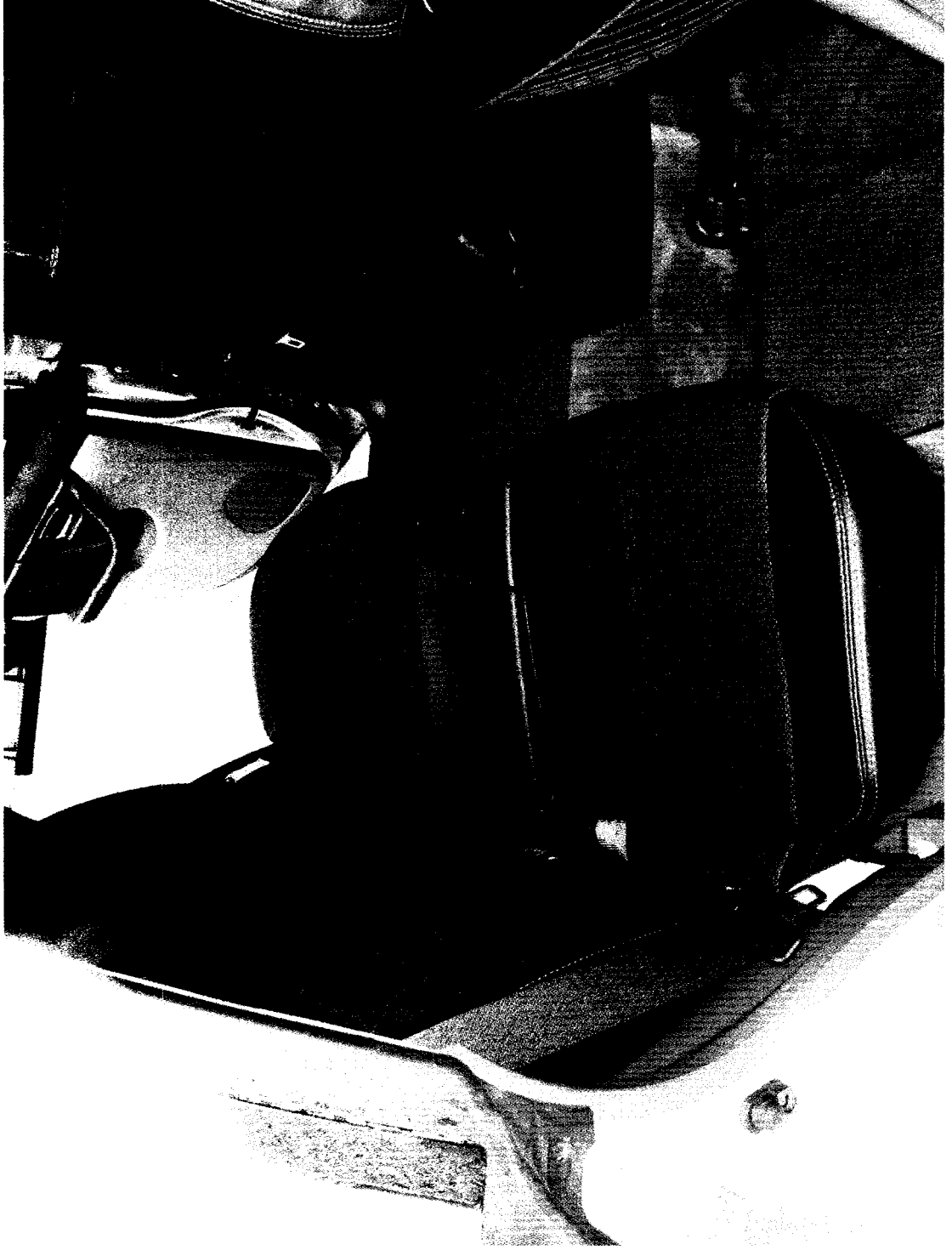

Strap for lifting rear seat

Photo 3

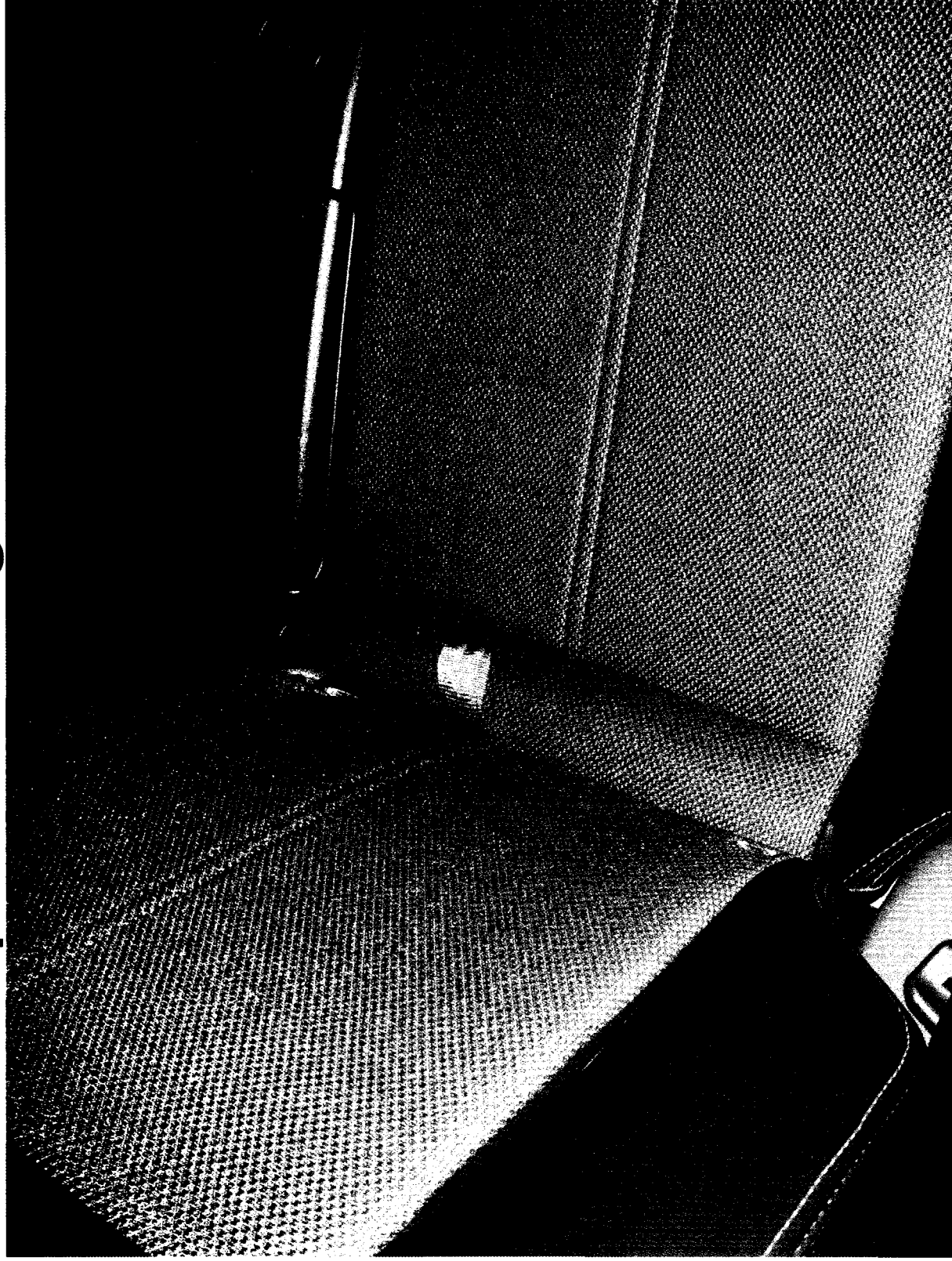

Rear Seat lifted and sound

Photo 4

deadening and carpet moved away



Photo 5

Cover over fuel pump area

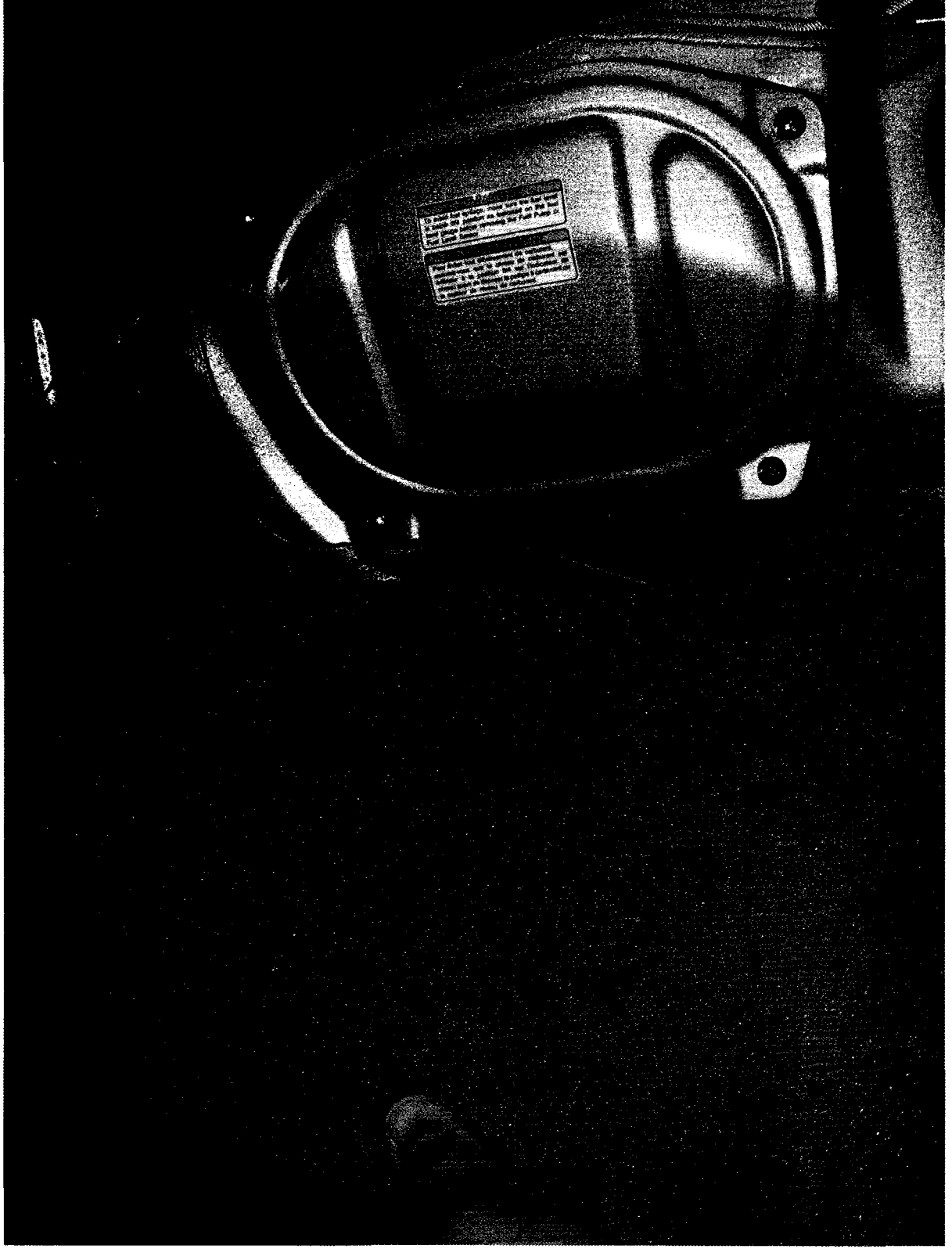

Cover over fuel pump area

Photo 6

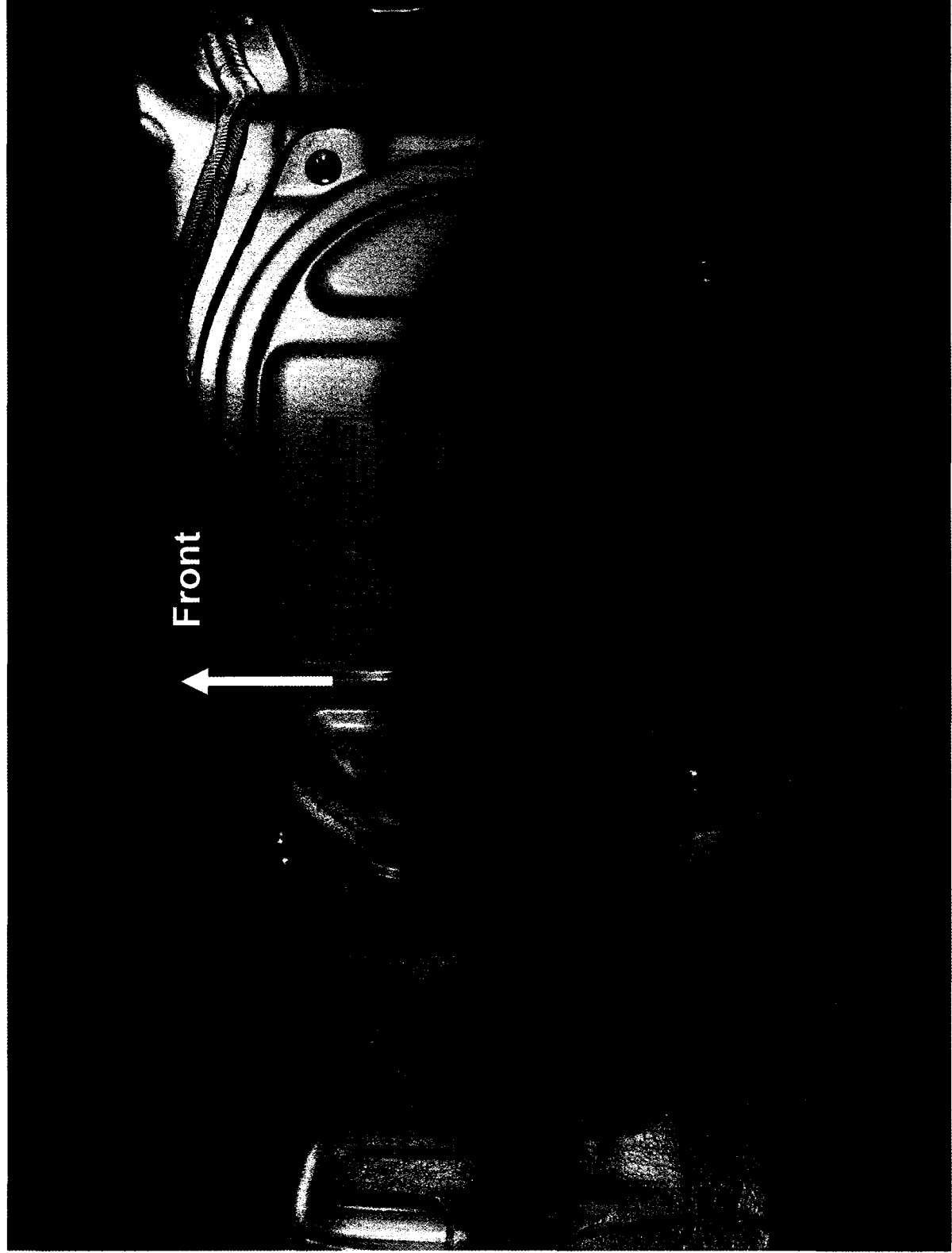

Photo 7

Fuel pump and sending unit

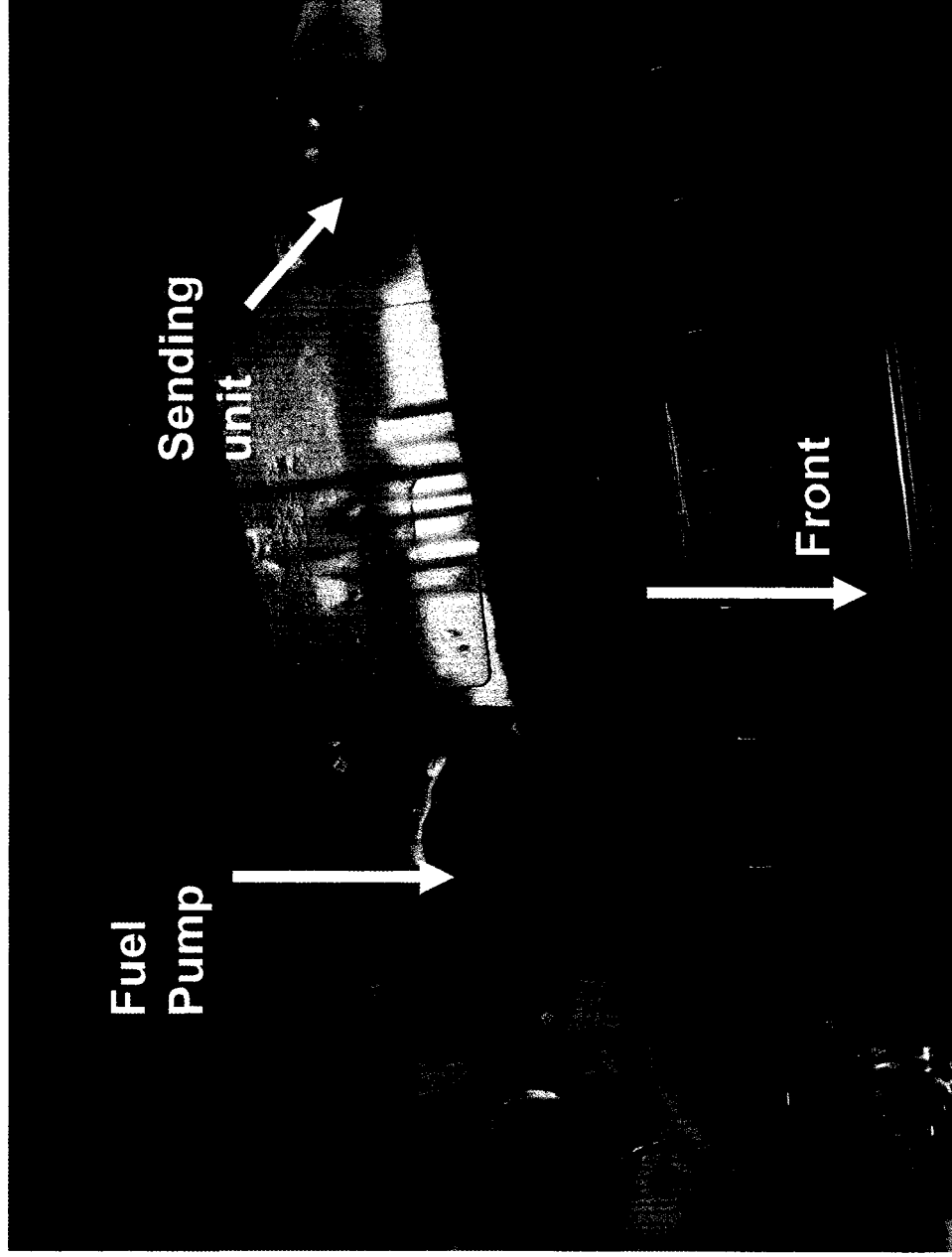
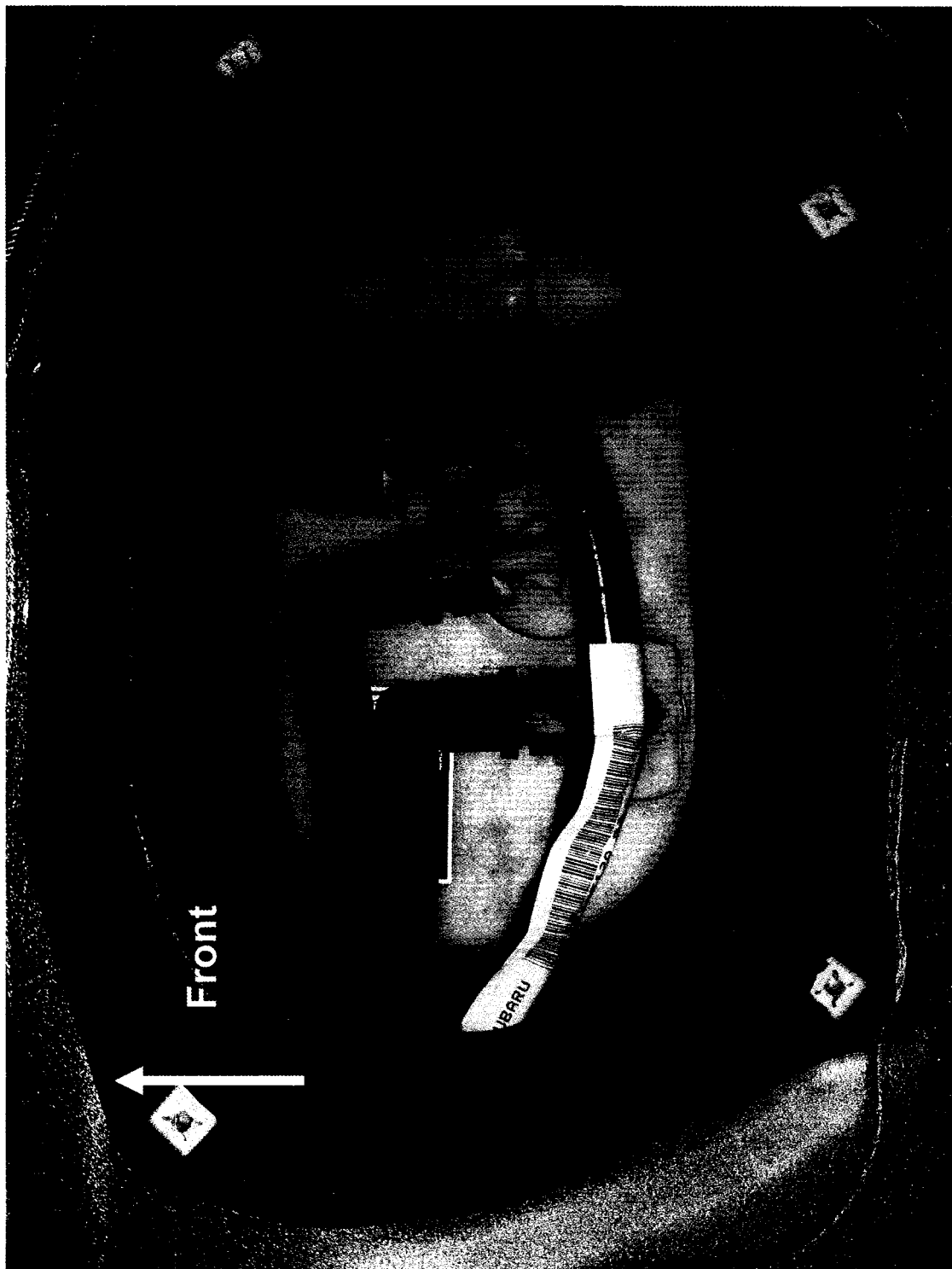
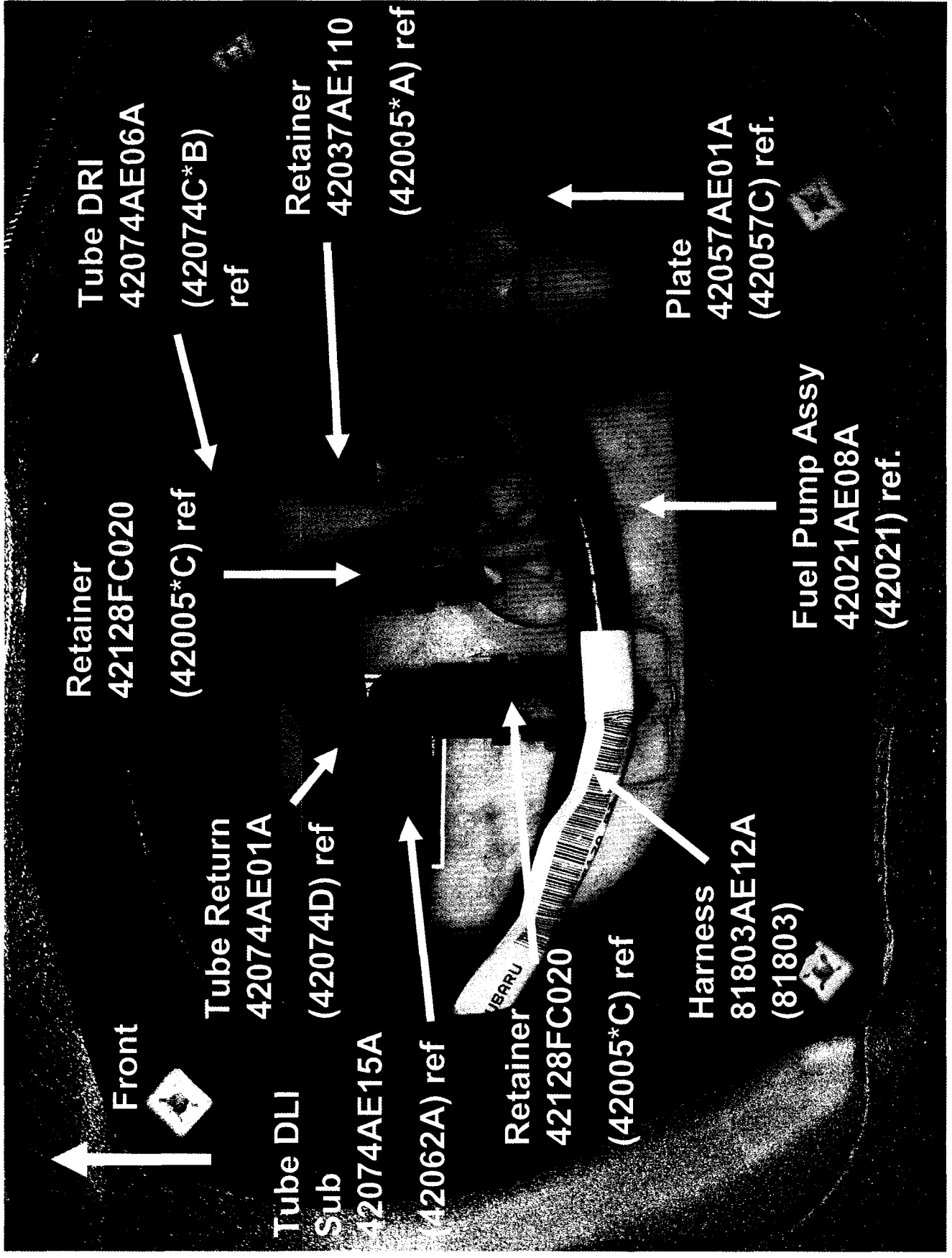

Photo 8

Fuel Pump Top View





Front

Tube DLI Sub
42074AE15A
(42062A) ref

Retainer
42128FC020
(42005*C) ref

Tube Return
42074AE01A
(42074D) ref

Retainer
42128FC020
(42005*C) ref

Tube DRI
42074AE06A
(42074C*B)
ref

Retainer
42037AE110
(42005*A) ref

Harness
81803AE12A
(81803)

Plate
42057AE01A
(42057C) ref.

Fuel Pump Assy
42021AE08A
(42021) ref.

Photo 10

Fuel Pump Top View

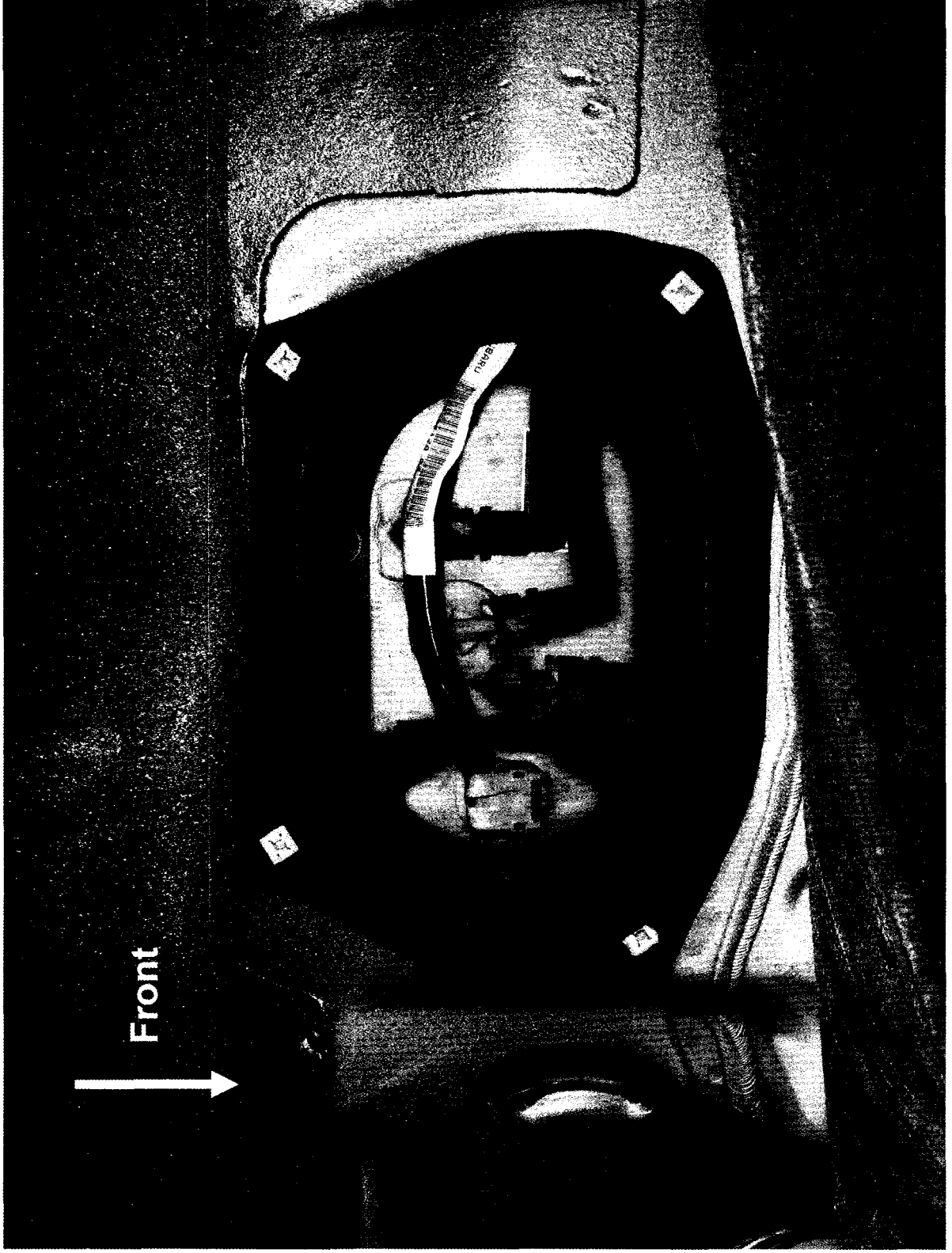

Sending Unit Cover

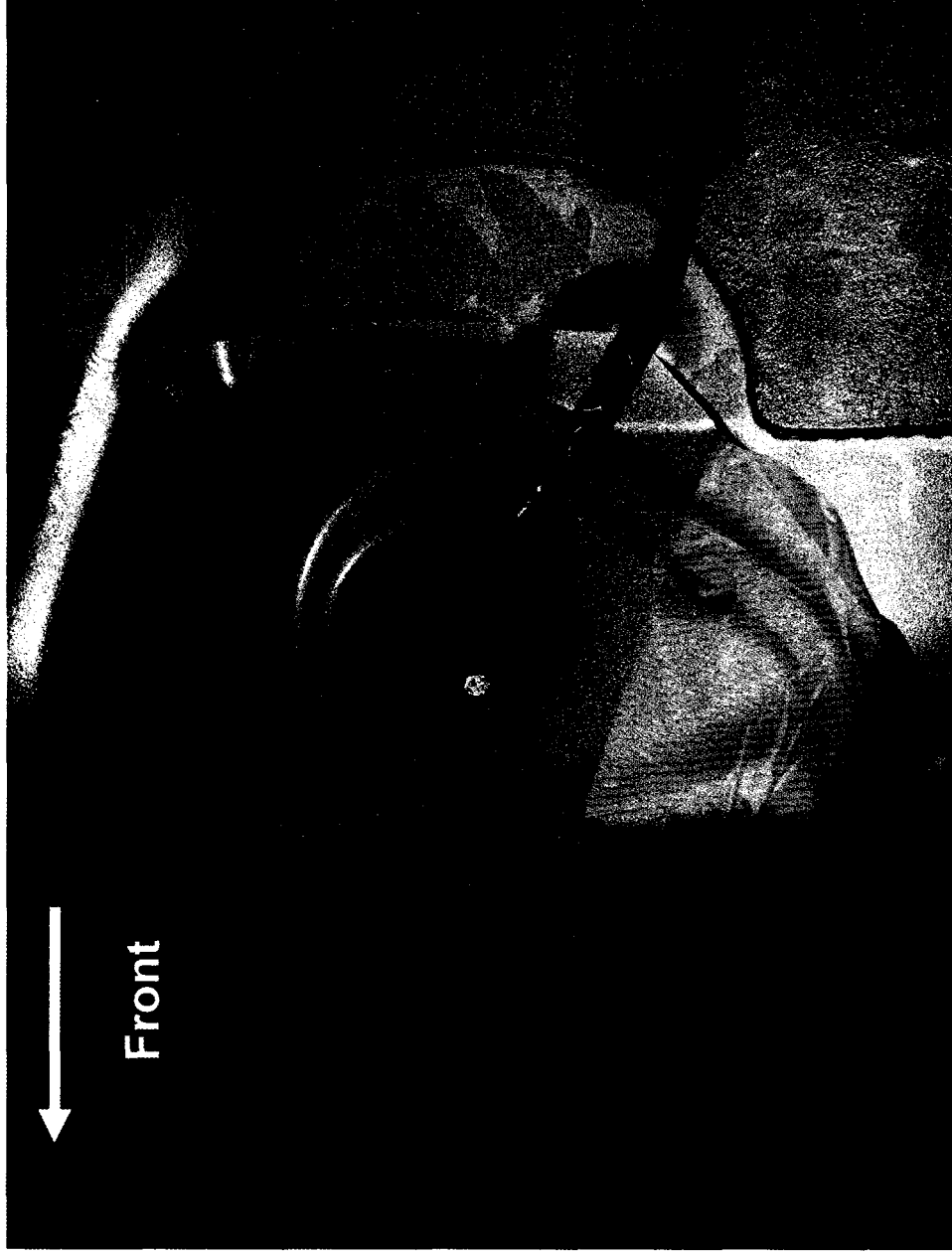

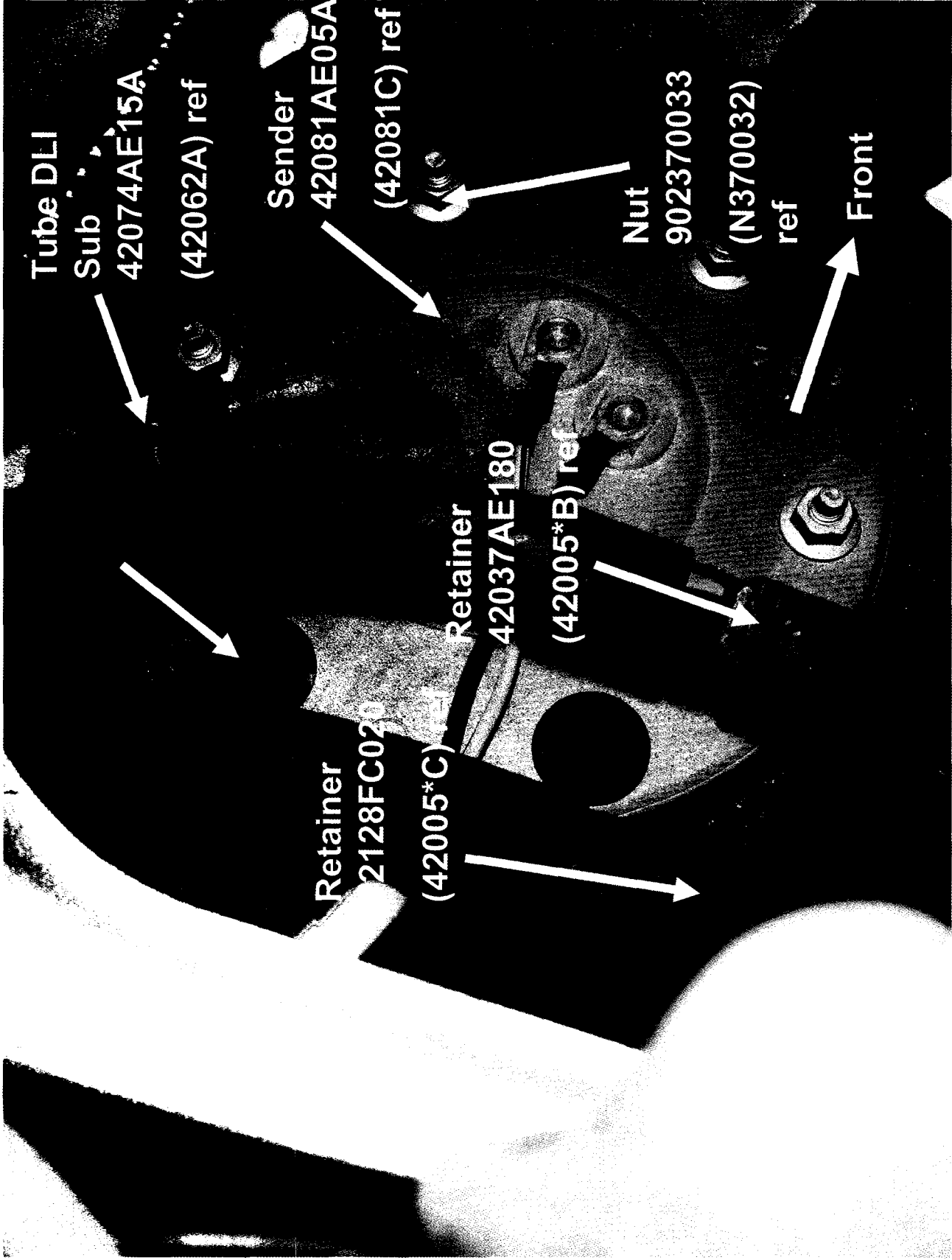

Tube DLI

Sub

42074AE15A

(42062A) ref

Sender

42081AE05A

(42081C) ref

Nut

902370033

(N370032)

ref

Front

Retainer

2128FC020

(42005*C) ref

Retainer

42037AE180

(42005*B) ref