

U.S. DEPARTMENT OF TRANSPORTATION
NATIONAL HIGHWAY TRAFFIC SAFETY ADMINISTRATION
LABORATORY TEST PROCEDURE

FOR

FMVSS No. 214, DYNAMIC SIDE IMPACT PROTECTION

-Moving Deformable Barrier Test Requirements-

APPENDIX C
ALUMINUM HONEYCOMB BARRIER STRENGTH TEST



ENFORCEMENT
Office of Vehicle Safety
Compliance Mail Code: NEF-240
1200 New Jersey Ave. SE
Washington, DC 20590

1.0 OBJECTIVE

The National Highway Traffic Safety Administration (NHTSA) developed a moving deformable barrier (MDB) for use in full-system crash tests. Attached to the MDB carriage is a crushable aluminum face that simulates the stiffness of the front end of a vehicle. All specifications for the MDB face assembly are found in Part 587.14.

Contractors must assure that aluminum honeycomb barriers used during compliance tests meet all specifications in accordance with Part 587.14. The test procedure contained herein provides a method to verify the required crush strength of a sample of aluminum material used to make the honeycomb barrier.

2.0 TEST PROCEDURE

2.1 Hardware Specifications

The hardware used for certifying aluminum honeycomb must be capable of applying a sufficient load (about 13.3 kn (3,000 lb)), over at least a 16.5 mm (0.65") stroke. The crush rate must be constant and known (see Section 3.3). To ensure that the load is applied to the entire sample, the top and bottom crush plates must be no smaller than 165 mm by 165 mm (6.5" x 6.5"). The engaging surfaces of the crush plates must also have a roughness approximately equivalent to 60 grit sandpaper. The bottom crush plate should be marked to ensure that the applied load is centered on the sample.

Also, the crush plate assemblies must have an average angular rigidity (about axis normal to the direction of crush) of at least 1017 N•m/deg (750 ft-lb/deg), over the range of 0 N•m to 203 N•m (0 ft-lb to 150 ft-lb) applied torque.

2.0 TEST PROCEDURE.....Continued

2.2 Sample Size

Samples of un-stabilized aluminum honeycomb are to be used that have the following dimensions;

Length = 152 mm ± 6 mm (6" ± 0.25")

Width = 152 mm ± 6 mm (6" ± 0.25")

Thickness = 25 mm ± 1.6 mm (1" ± 0.0625")

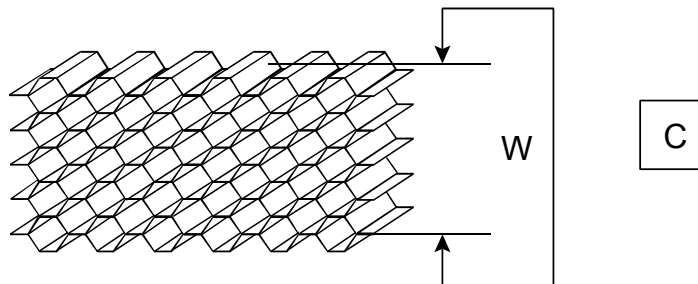
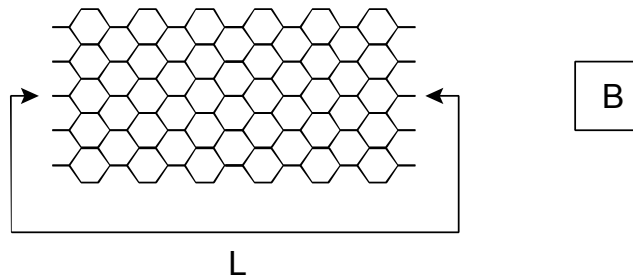
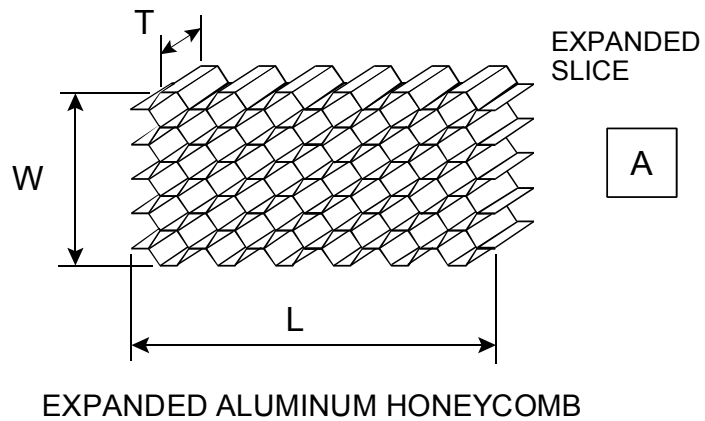

2.0 TEST PROCEDURE.....Continued

2.3 Measurement of the Sample

Three length measurements are taken, fringe to fringe, and recorded as L1, L2, and L3. These are to be located one-half of an inch from each end and at the middle of each sample. If these locations fall between the fringes, the measurements are to be taken from lines projected between the adjacent fringes, as shown in Figure 1, Item B. In the same manner, the width is to be measured and recorded as W1, W2 and W3. All length and width measurements are to be taken at the centerline plane of the thickness, as shown in Figure 1, Item C. The crush area is then calculated using the following formula:

$$A = \frac{(L1 + L2 + L3)}{3} \times \frac{(W1 + W2 + W3)}{3}$$

2.4 Crush Rate and Distance

The sample is to be crushed at a rate not less than 5 mpm (0.2 ipm) and not more than 7.6 mpm (0.3 ipm). The sample is to be crushed a minimum of 16.5 mm (0.65").

2.5 Data Collection

Force versus deflection data are to be collected in either analog or digital form for each sample tested. If analog data are collected, a means of converting this to digital data must be available. All digital data must be collected at a rate of no less than 5 Hz (5 points per second). The rated tolerance on the load cell used to obtain this data must not be more than ± 0.5 percent, while that of the displacement transducer used must not exceed ± 1 percent. The calibration interval for each of these must be less than six months and the standard must be traceable to NIST.

2.0 TEST PROCEDURE...Continued

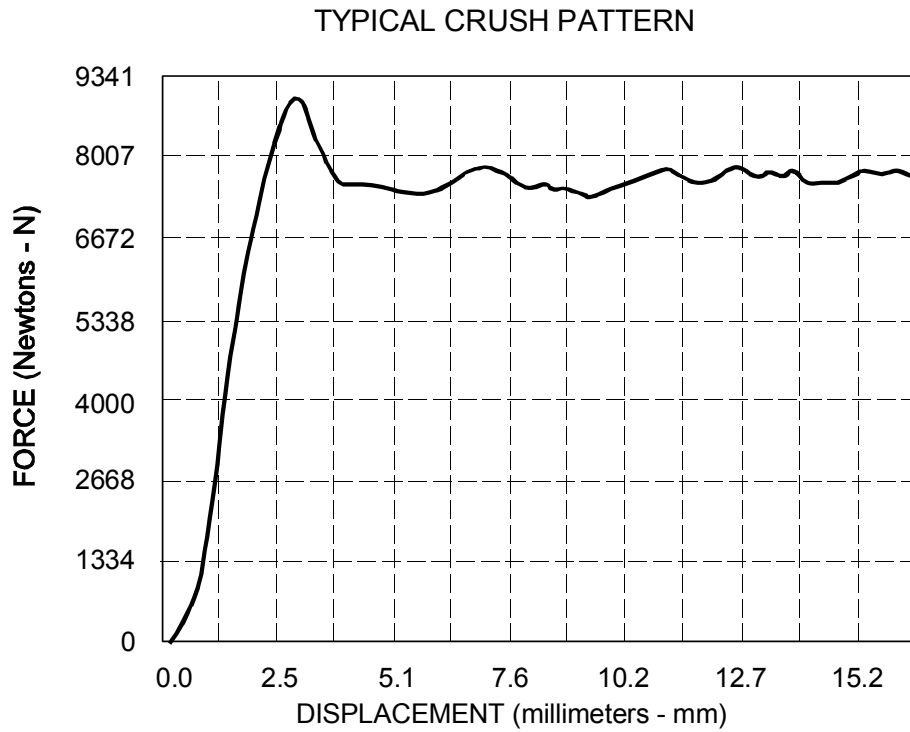

FIGURE 2

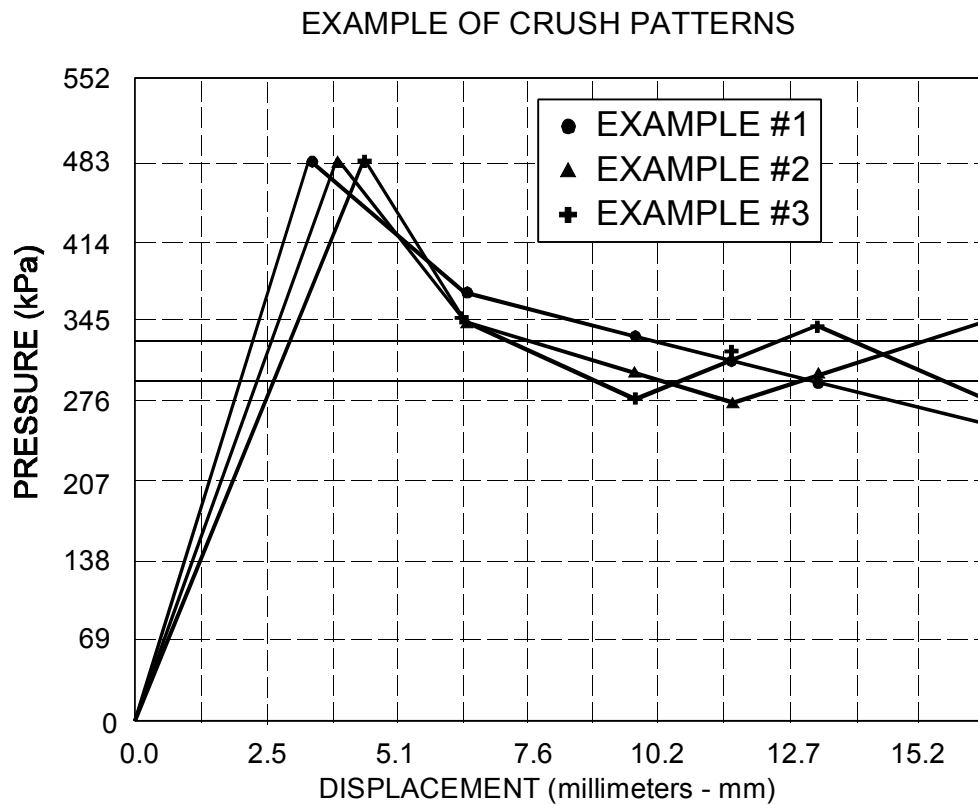

FIGURE 3

2.0 TEST PROCEDURE....Continued

2.6 Crush Strength Determination

Ignore all data prior to 6 mm (0.25") of crush and after 16.5 mm (0.65 inch) of crush. Divide the remaining data into three sections or displacement intervals ($n = 1, 2, 3$) as follows:

- A. 6.4 mm to 9.7 mm (0.25" to 0.38"), inclusive
- B. 9.7 mm to 13.2 mm (0.38" to 0.52"), exclusive
- C. 13.2 mm to 16.5 mm (0.52" to 0.65"), inclusive

Find the average force for each section as follows:

$$F(n) = \frac{[F(n)_1 + F(n)_2 + \dots + F(n)_l]}{l}; \quad n = 1, 2, 3$$

In this equation, "l" represents the number of data points measured in each of the three intervals. Calculate the average crush strength of each section as follows:

$$S(n) = \frac{F(n)}{A}; \quad n = 1, 2, 3$$

2.7 Sample Crush Strength Specification

For a honeycomb sample to pass this certification, the following condition must be met:

$$293 \text{ kPa} \leq S(n) \leq 327 \text{ kPa} \quad (42.5 \text{ psi} \leq S(n) \leq 47.5 \text{ psi})$$

$n = 1, 2, 3$

2.8 Block Crush Strength Specification

Eight (8) samples are to be tested from 4 locations, evenly spaced across the block. For a block to pass certification, 7 of the 8 samples must meet the crush strength specification outlined in 2.7.

HONEYCOMB SAMPLE LOCATIONS

**IF $A \geq 914$ mm: $X = 1/3(B - 610$ mm) & $Y = 1/3 (A - 610)$
 [FOR $A \leq B$]**

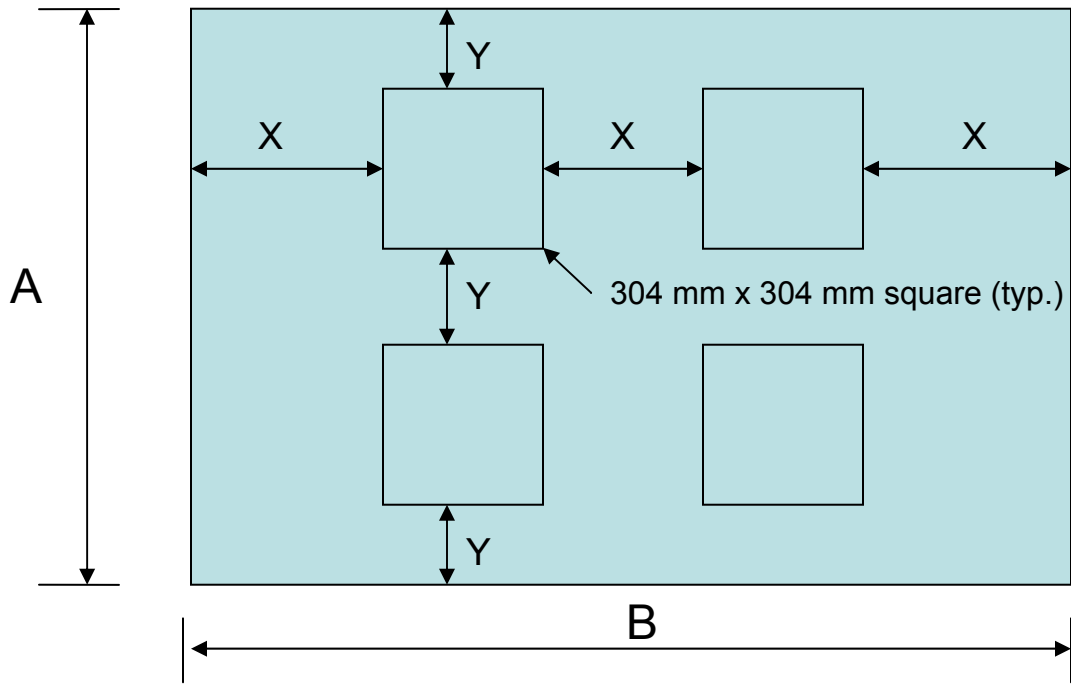

**IF $A < 914$ mm: $X = 1/5(B - 1220$ mm) & $Y = 1/2 (A - 304$ mm)
 [FOR $A \leq B$]**

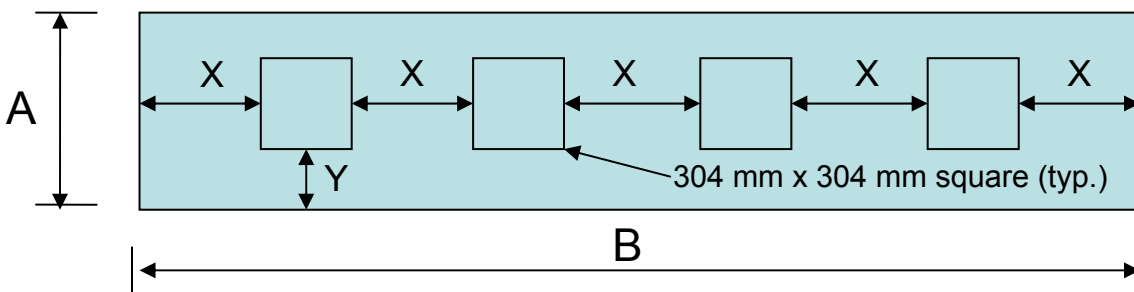

FIGURE 4